



NANYANG PRIMARY SCHOOL  
PRIMARY 4 SCIENCE  
SEMESTRAL ASSESSMENT 1  
2019

**BOOKLET A**

Date : 15 May 2019  
Duration : 1 h 45 min

Name : \_\_\_\_\_ (     )

Class: Primary 4 (     )

**DO NOT OPEN THIS BOOKLET UNTIL YOU ARE TOLD TO DO SO.  
FOLLOW ALL INSTRUCTIONS CAREFULLY.**

Booklet A consists of 20 printed pages including this cover page.



**Section A**

For each question from 1 to 28, four options are given. One of them is the correct answer. Indicate your choice in this booklet and shade the correct oval (1, 2, 3 or 4) on the Optical Answer Sheet provided.

1. Study the diagram below.

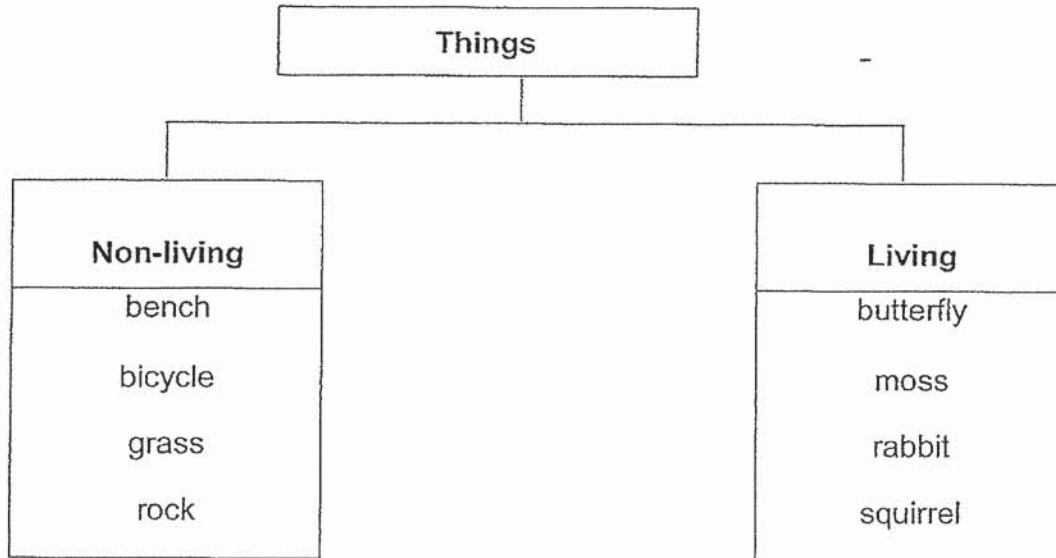

Which one of the following has been placed in the **wrong** group?

- |             |               |
|-------------|---------------|
| (1) Bicycle | (2) Butterfly |
| (3) Grass   | (4) Moss      |

2. The table below shows the different characteristics of C, D and E. A tick (✓) shows that the characteristic is present.

Characteristic	C	D	E
Can grow		✓	✓
Can reproduce		✓	✓
Can move freely from one place to another	✓		✓
Needs air, food and water to stay alive		✓	✓

Which one of the following best represents C, D and E?

	C	D	E
(1)	bracket fungus	rose plant	toy rabbit
(2)	rose plant	toy rabbit	toy car
(3)	toy car	bracket fungus	butterfly
(4)	toy rabbit	butterfly	rose plant

3. The diagram below shows 2 adult plants, Plant G and Plant H.



Plant G



Plant H

Which one of the following statements about plants G and H is **true**?

- (1) G lives in water but H lives on land.
- (2) G bears flowers but H does not bear flowers.
- (3) G reproduces by spores but H reproduces by seeds.
- (4) G can make its own food but H cannot make its own food.

4. Which of the following are correct function(s) of leaves?

- A Traps light to make food for the plant
- B Takes in water and mineral salts for the plant
- C Carries out gaseous exchange through the tiny openings

- (1) A only
- (2) B only
- (3) A and C only
- (4) B and C only

5. Study the flowchart below.

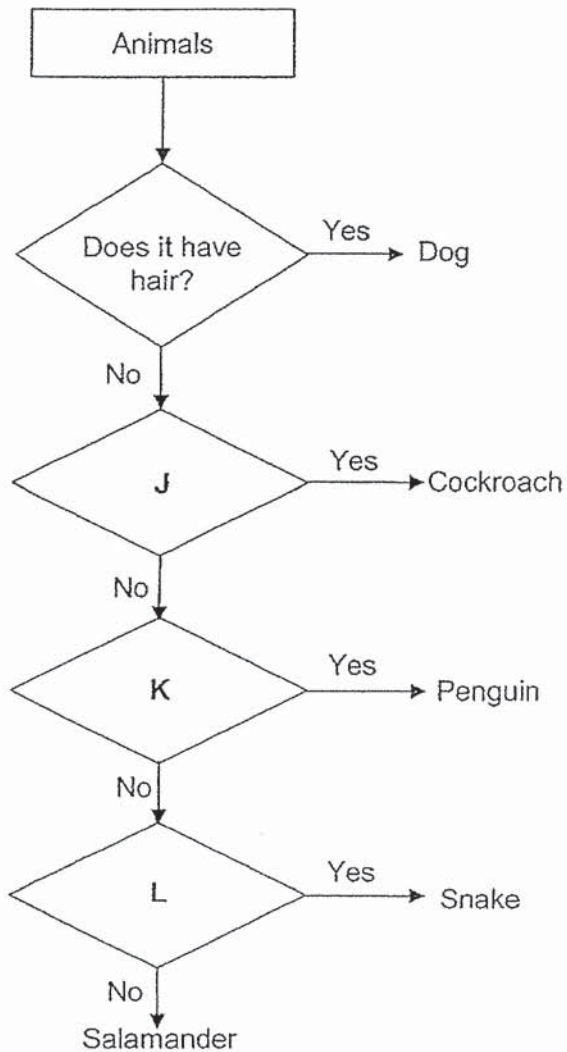

Which one of the following best represents questions J, K, and L?

	<b>J</b>	<b>K</b>	<b>L</b>
(1)	Does it have scales?	Does it have wings?	Does it have moist skin?
(2)	Does it have feelers?	Does it have feathers?	Does it have scales?
(3)	Does it give birth to young alive?	Does it have a beak?	Does it have scales?
(4)	Does it have 3 body parts?	Does it have feathers?	Does it have moist skin?

6. The diagram below shows how some animals have been grouped.

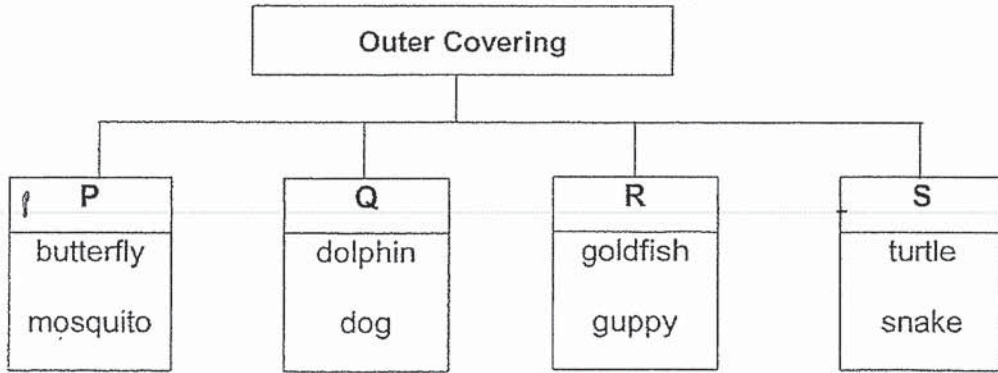

In which group should Animal X, shown below, be placed?

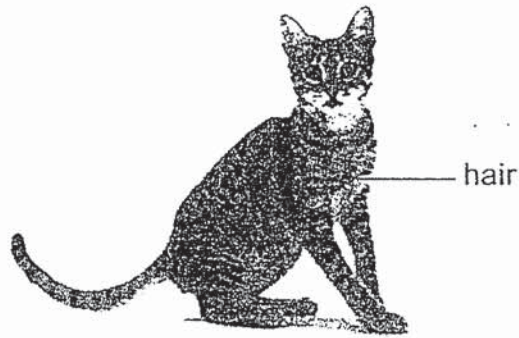

- (1) P
- (3) R

- (2) Q
- (4) S

7. John had two similar plants. He removed the roots of one plant and placed each of them in a beaker containing 250 ml of water, as shown below.

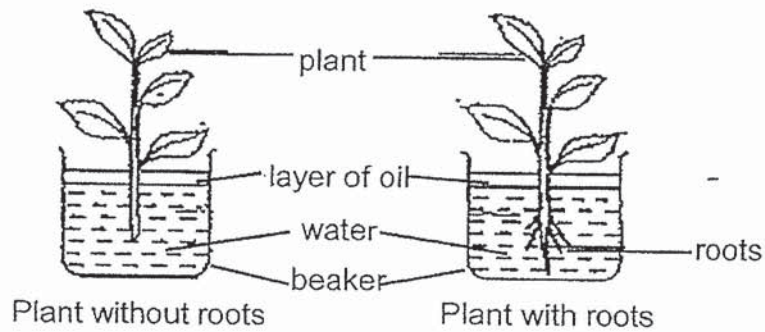

Which one of the following shows the possible volumes of water for each set-up after three days?

	Plant without roots	Plant with roots
(1)	230 ml	200 ml
(2)	250 ml	250 ml
(3)	270 ml	200 ml
(4)	250 ml	270 ml

8. The table below shows the functions of two plant parts, X and Y.

Plant part	Function
X	Supports the plant
Y	Anchors the plant firmly to the ground

Which one of the following best represents X and Y?

	X	Y
(1)	Roots	Leaves
(2)	Stem	Roots
(3)	Leaves	Stem
(4)	Roots	Stem

9. Which one of the following correctly matches the organ systems to their functions?

	Organ Systems	Functions
(1)	Skeletal	To allow the body to remove water from the large intestine
(2)	Muscular	To protect important organs in the body
(3)	Respiratory	Takes in air into the body and removes air from the body
(4)	Circulatory	Breaks down food into simpler substances and absorbs nutrients into the bloodstream

10. Which of the following statements about the human digestive system are false?

- A Digestion starts in the stomach. X
- B Saliva in the mouth helps to break down the food.
- C Digested food is directly transported from the small intestine to the large intestine.
- D Digestive juices are added to break down the food in the mouth, stomach and small intestine.

(1) A and B only

(2) A and C only

(3) B and D only

(4) A, C and D only



11. The flowchart below shows the human digestive system.

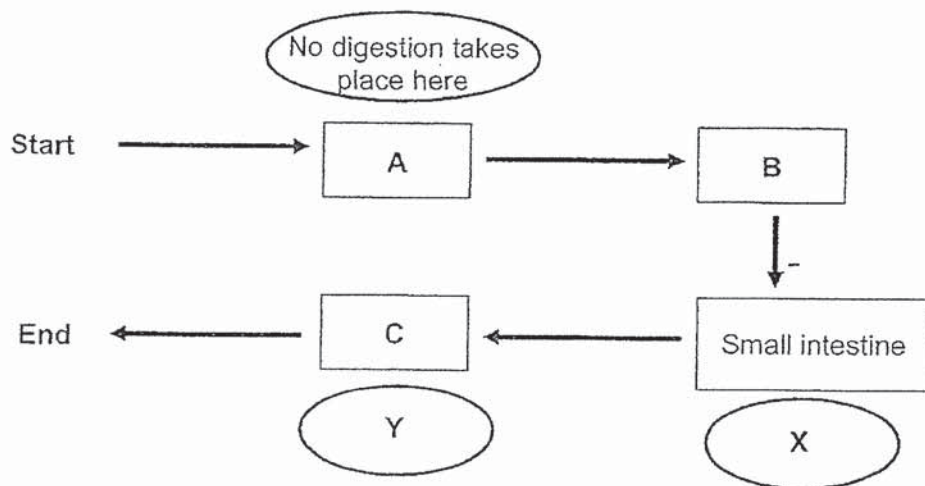

Based on the flowchart above, which one of the following represents the parts A, B, C and functions X and Y correctly?

	A	B	C	X	Y
(1)	mouth	gullet	large intestine	digestive juices added	removes waste from the body
(2)	gullet	stomach	large intestine	absorbs nutrients into blood stream	removes water from the undigested food
(3)	gullet	stomach	anus	digestion starts here	removes water from the undigested food
(4)	stomach	large intestine	anus	absorbs nutrients into blood stream	removes waste from the body

12. The graph below shows the amount of undigested food in different organs, D, E and F, in the human digestive system.

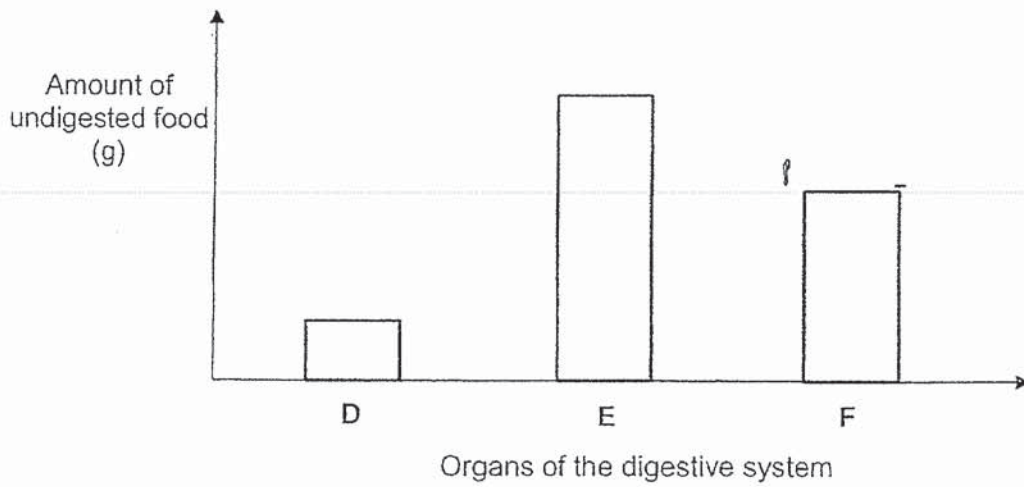

Based on the graph above, which of the following correctly represents D, E and F?

	D	E	F
(1)	large intestine	mouth	stomach
(2)	small intestine	stomach	large intestine
(3)	mouth	small intestine	gullet
(4)	stomach	gullet	small intestine

13. The table below shows some materials grouped according to whether they are magnetic or non-magnetic.

Magnetic materials	Non-magnetic materials
Iron	Steel
Copper	Aluminium

Which two materials have been grouped **wrongly**?

- (1) Iron and Steel  
 (2) Copper and Steel  
 (3) Aluminium and Iron  
 (4) Aluminium and Copper
14. Zann wanted to make an object into a temporary magnet using the stroke method. Which of the following steps below would enable her to make a temporary magnet?
- A Use a magnetic material  
 B Stroke the object using both poles of a magnet  
 C Use a magnet to stroke the object in one direction only

- (1) A and B only  
 (2) A and C only  
 (3) B and C only  
 (4) A, B and C

15. Study the classification diagram below.

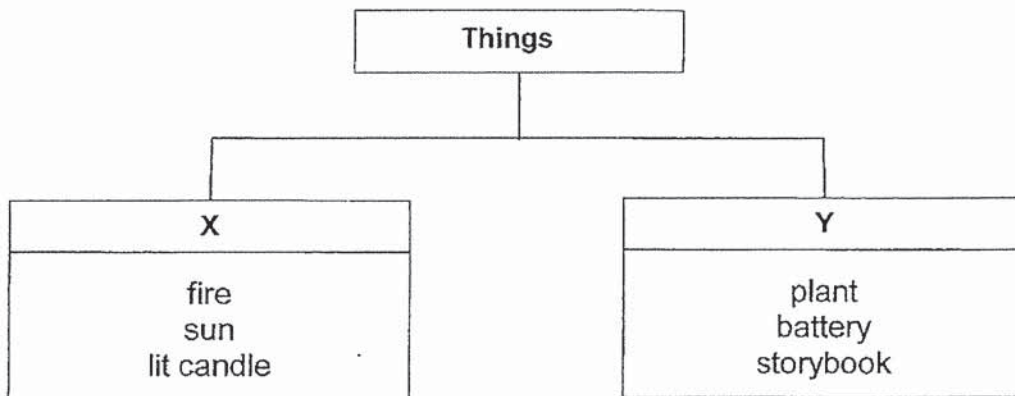

Which one of the following headings best represents headings X and Y?

	X	Y
(1)	Living things	Non-living things
(2)	<del>Not waterproof</del> Cannot grow	<del>Waterproof</del> Can grow
(3)	Give off light	Do not give off light
(4)	Do not allow light to pass through it	Allow light to pass through it

16. Which one of the following statements about light is correct?

- (1) All objects can produce light on their own.
- (2) A lit torch and fire are natural sources of light.
- (3) Light can pass through objects that are made of metal.
- (4) We can see an object when the light that shines on it is reflected into our eyes.

17. Talib set up an experiment to find out if object P in a dark box could be seen from outside the box. He made two holes at points S and T. He shone a torch through point S, and he looked through point T.

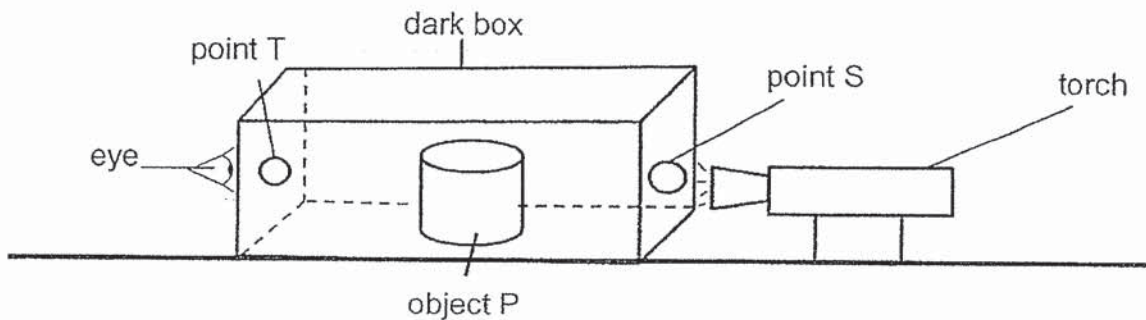

Which one of the following **is wrong**?

- (1) He would be able to see object P in the dark box.
- (2) He would be able to see the light source at Point S.
- (3) He would not be able to see anything in the dark box.
- (4) He would not be able to see the inner sides of the dark box.

18. In the diagram below, three children were standing at a fixed position behind a screen. Each screen was made of different materials. The children were allowed to move their bodies to look at their surroundings without stepping out of their fixed positions.

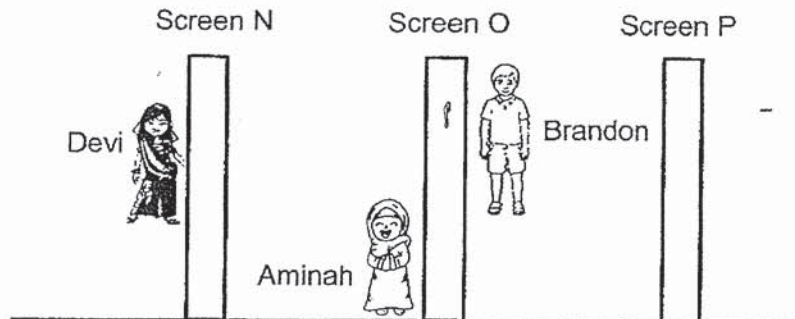

The three children made the following statements:

Devi : I could see no one.

Aminah : I could see Brandon only.

Brandon: I could see Aminah and my reflection only.

Based on the statements above, which one of the following best represents the materials used to make the screens?

	<b>N</b>	<b>O</b>	<b>P</b>
(1)	metal sheet	mirror	clear plastic sheet
(2)	clear plastic sheet	cardboard	Mirror
(3)	mirror	metal sheet	cardboard
(4)	cardboard	clear plastic sheet	Mirror

19. Melvin wanted to find out how different materials will affect the amount of light given off by a lit light bulb. He made three covers with three different materials X, Y and Z. The light sensor was connected to a datalogger to detect the amount of light. A light sensor was placed next to the cover as shown in the diagram below.

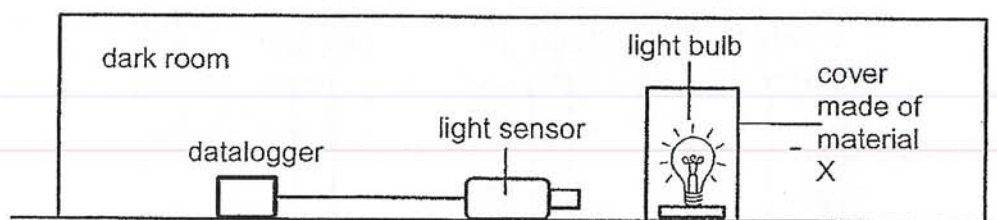

He placed cover X over the lit light bulb and measured the amount of light passing through it. He repeated the steps with covers Y and Z. The results were recorded in table below.

Material	Amount of light detected (lux)
X	278
Y	0
Z	30

Based on the results of the table above, which of the following statement(s) is/are true?

- A Only Material X allowed light to pass through.
- B We could see light given off by the light bulb when the light bulb was covered with Materials X and Z only.
- C The amount of light passing through Material Y was greater than the amount of light passing through Material Z.

(1) A only

(2) B only

(3) A and C only

(4) B and C only

20. Sharon set up an experiment in a dark room as shown below. A shadow of the object was formed on the screen. The object is shown on the right.

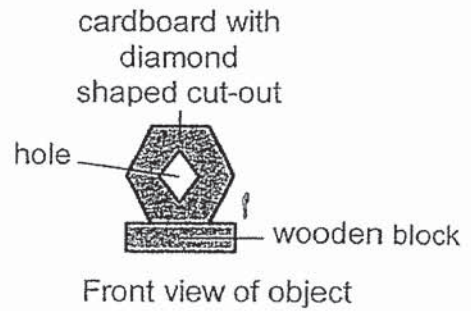
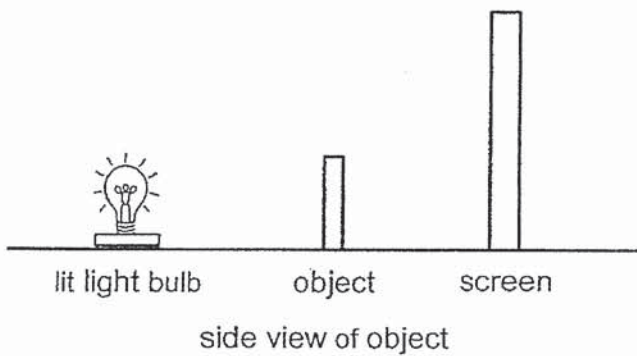

Which one of the following shadows would Sharon be able to observe?

(1)

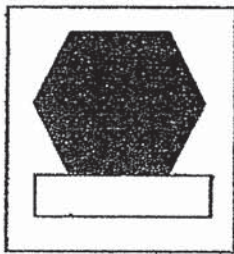

(2)

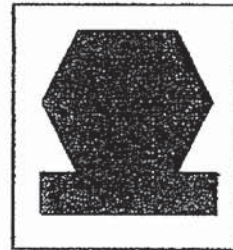

(3)



(4)

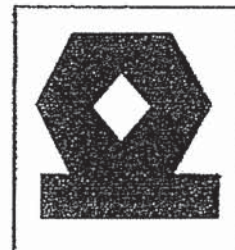

21. The three objects below are made of the same material that does not allow light to pass through them.

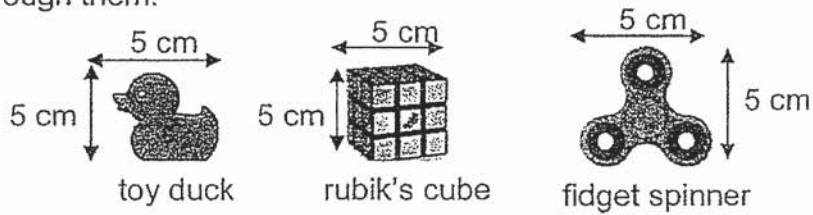

The objects were hung at fixed positions E, F and G to cast a shadow on the screen as shown below.

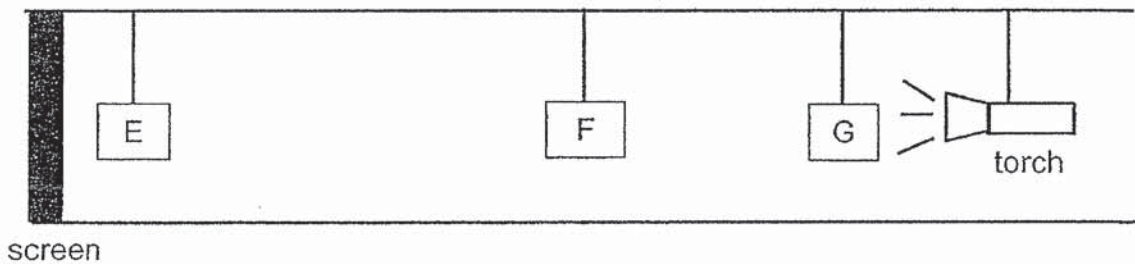

Based on the shadow formed shown above, which of the following correctly matches the positions that the objects were hung at?

	E	F	G
(1)	toy duck	rubik's cube	fidget spinner
(2)	rubik's cube	toy duck	fidget spinner
(3)	fidget spinner	rubik's cube	toy duck
(4)	rubik's cube	fidget spinner	toy duck



22. Meilan was cutting some paper in her room at night. She turned on the light so that she could see clearly.

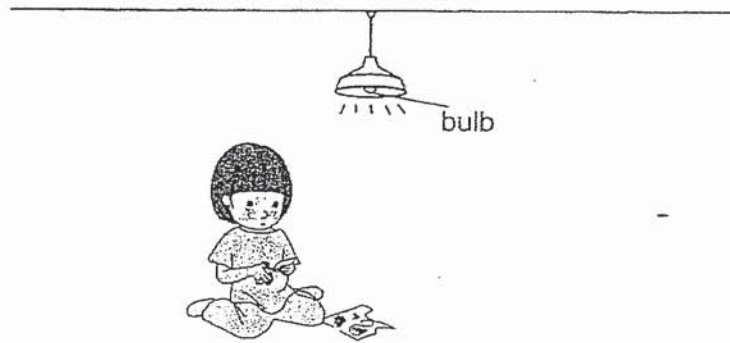

Which one of the following shows the path of light for Meilan to see clearly what she was cutting?

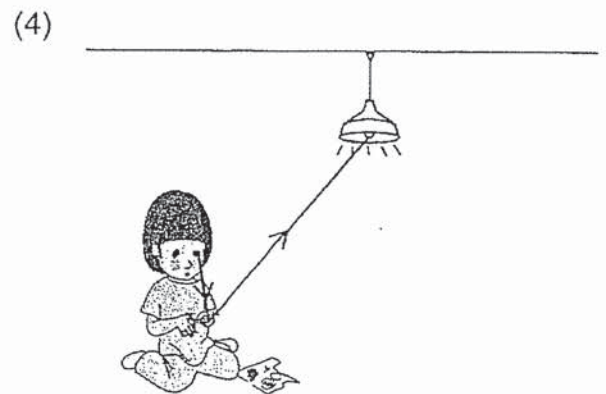
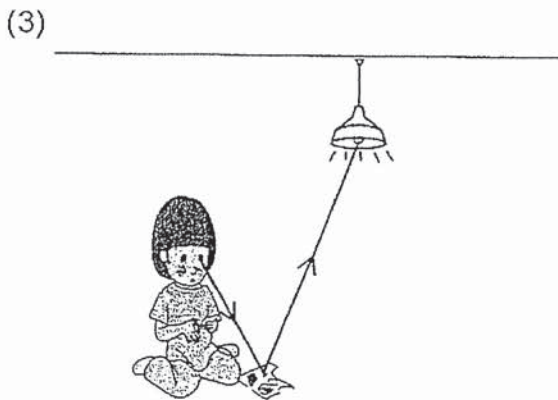
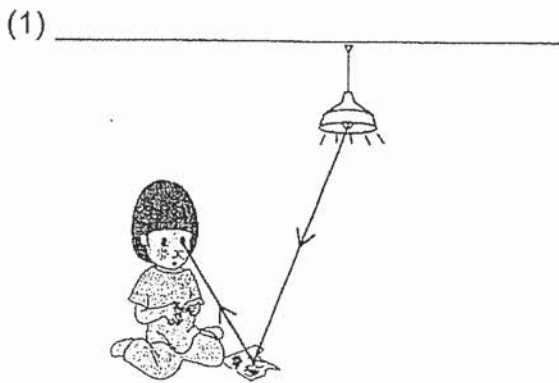

23. Ming Yi used a hand pump to pump air into the glass container as shown below. She observed that the size of the glass container still remained the same after some time.

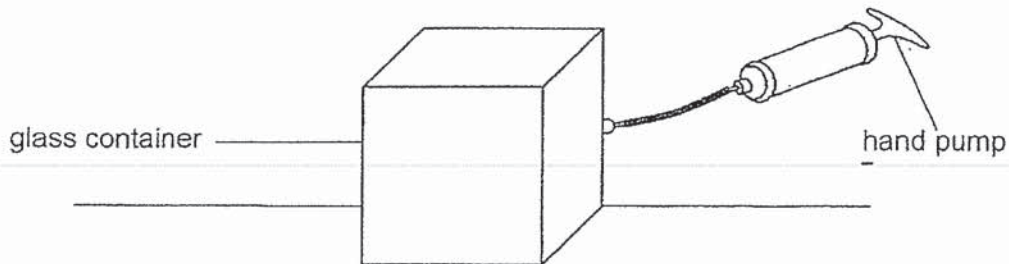

Which one of the following best explains her observation?

- (1) Air occupies space.
  - (2) Air can be compressed.
  - (3) A solid can be compressed.
  - (4) A solid has a definite volume.
24. Ali added substances Q and R, into two similar glass containers as shown below.

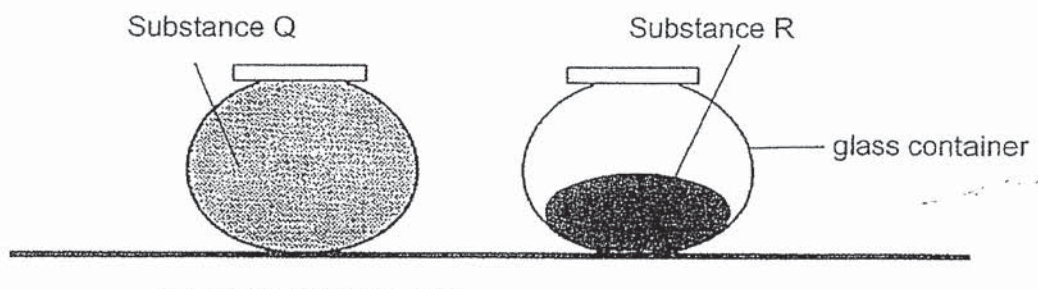

Ali made the following statements:

- A R is a solid
- B Q can be a liquid
- C R can be compressed
- D Q has a definite shape

Based on the observations above, which of the statements are definitely correct?

- (1) A and B only
- (2) B and C only
- (3) C and D only
- (4) A, B and D only

25. Mary filled two identical beakers with the same amount of water. She then added different objects, X and Y, into each beaker. She observed the final water level in each beaker as shown below.

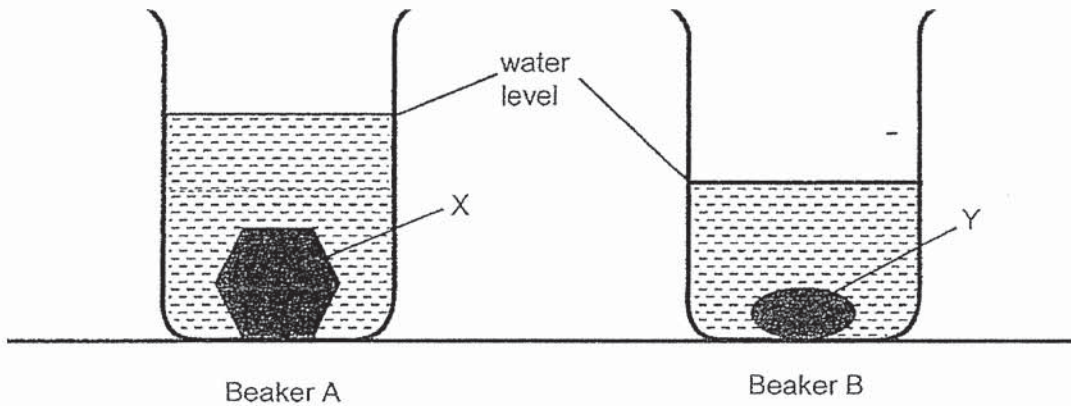

Based only on her observations, which of the following statement(s) are correct?

- A Objects X and Y have definite shapes.
- B Objects X and Y have definite volumes.
- C Object X has a larger volume than object Y.

- (1) C only
- (2) A and B only
- (3) B and C only
- (4) A, B and C

26. The diagram below shows three balloons of different shapes when they are filled with air.



Which one of the following properties correctly explains the shapes of the air in the balloons?

- (1) Air has mass
- (2) Air can be compressed
- (3) Air has no definite shape
- (4) Air has no definite volume

27. Bala lowered a glass with a small plastic ball into a container of water until the glass touched the bottom of the container. He observed that the water level inside the glass was not the same as the water level in the container. The ball floated on the water as shown below.

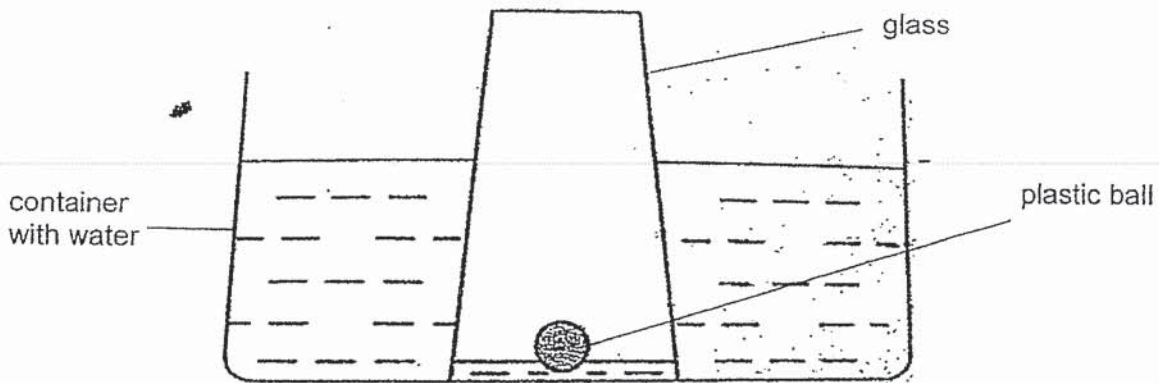

Which one of the following statements explains the difference in the water level inside and outside the glass?

- (1) The ball in the glass takes up space.
  - (2) The air inside the glass takes up space.
  - (3) The ball pushed the water out from the glass.
  - (4) The air in the glass is compressed by the ball.
28. The table below describes the properties of three different states of matter, A, B and C.

Property	A	B	C
Definite shape	No	Yes	No
Definite volume	No	Yes	Yes

Based on the table above, which one of the following is correct?

	A	B	C
(1)	gas	liquid	solid
(2)	liquid	solid	gas
(3)	solid	liquid	gas
(4)	gas	solid	liquid

~ End of Booklet A ~



NANYANG PRIMARY SCHOOL

PRIMARY 4 SCIENCE

SEMESTRAL ASSESSMENT 1  
2019

**BOOKLET B**

Date : 15 May 2019

Duration : 1 h 45 min

Name : \_\_\_\_\_ ( )

Class: Primary 4( )

Marks Scored:

Booklet A:		56
Booklet B :		44
Total :		100

Any query on marks awarded should be raised by 24 May 2019. We seek your understanding in this matter as any delay in the confirmation of marks will lead to delays in the generation of results.

Parent's signature: \_\_\_\_\_

DO NOT OPEN THIS BOOKLET UNTIL YOU ARE TOLD TO DO SO.  
FOLLOW ALL INSTRUCTIONS CAREFULLY.

Booklet B consists of 16 printed pages including this cover page.

**BLANK PAGE**

Section B

Write your answers to questions 29 to 40 in the spaces provided.

29. Hui Xin observed the height of a young plant and a toy doll over three weeks. She recorded her observations in the two graphs below.

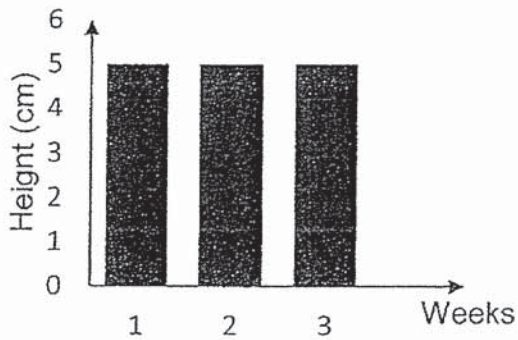

Graph A

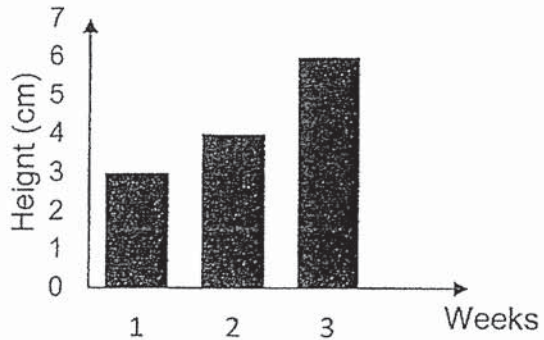

Graph B

- (a) Put a tick (✓) in the correct boxes to identify which graph shows the results for the young plant and the toy doll. [1]

	Graph A	Graph B
Young Plant		
Toy Doll		

- (b) What characteristic of living things is shown in graph B? [1]

\_\_\_\_\_

Hui Xin then observed that she has a toy car that could move from one place to another when she pushed it. Based only on this observation, she concluded that her toy car was a living thing.

- (c) Give two reasons why she is wrong. [2]

(i) \_\_\_\_\_

\_\_\_\_\_

(ii) \_\_\_\_\_

\_\_\_\_\_



30. Study the flowchart below.

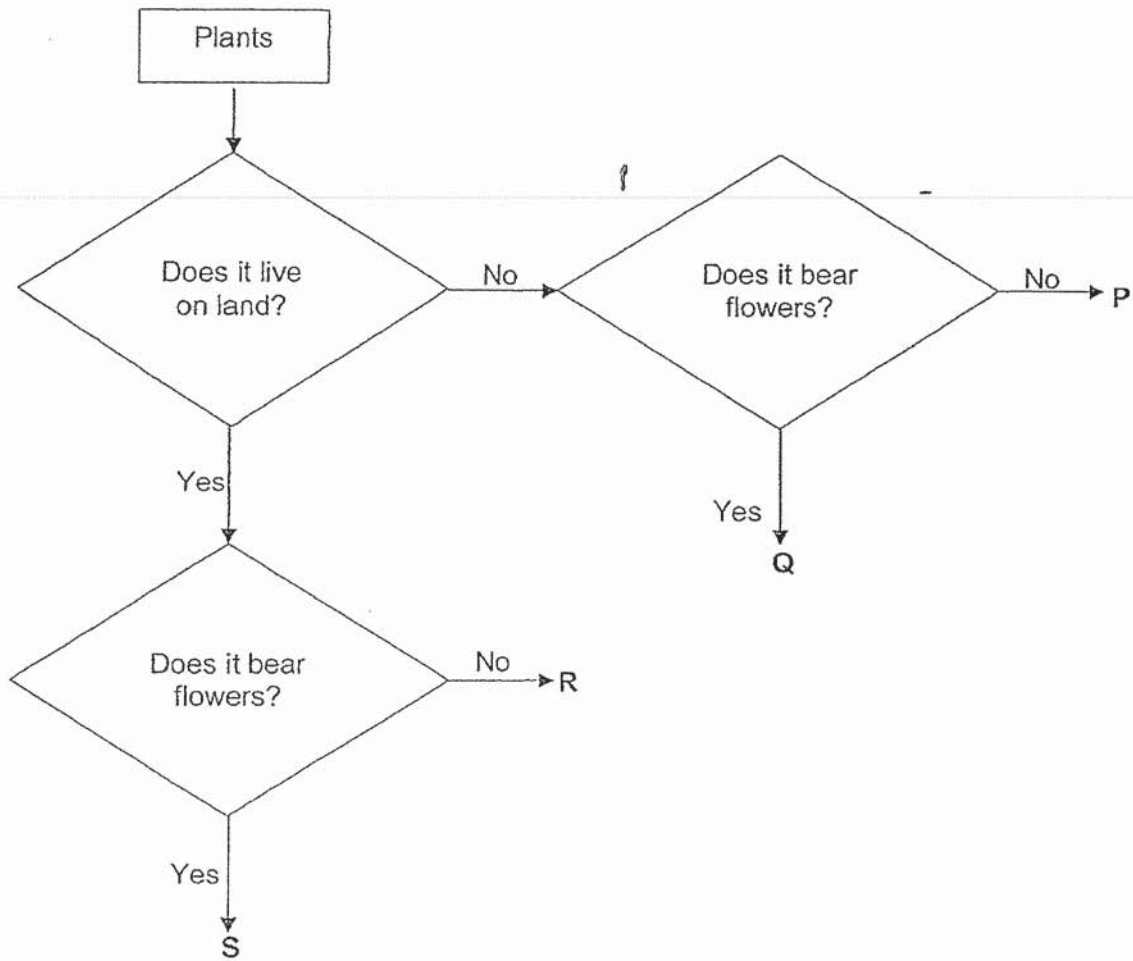

(a) Based only on the chart above, state a similarity between plants Q and S. [1]

---

---

(b) Based only on the chart above, state a difference between plants P and R. [1]

---

---

(c) Name an example of plant R and plant S. [1]

Plant R: \_\_\_\_\_

Plant S: \_\_\_\_\_



31. Animals M and N are shown below.

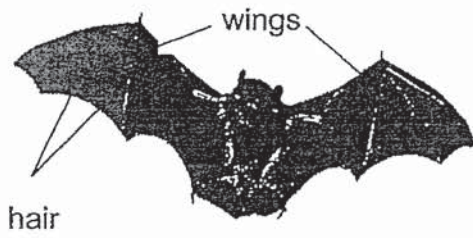

Animal M

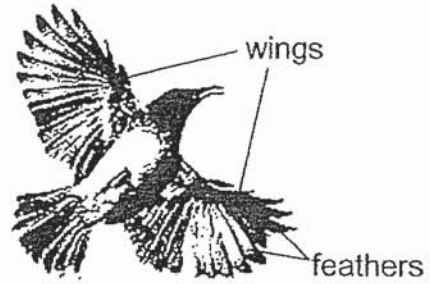

Animal N

(a) Based only on the diagrams above, state a similarity between the two animals. [1]

---

---

(b) Based only on the diagrams above, state a difference between the two animals. [1]

---

---

(c) Identify the groups of living things that animals M and N belong to. [1]

Animal M: \_\_\_\_\_

Animal N: \_\_\_\_\_

Animal P is shown below.

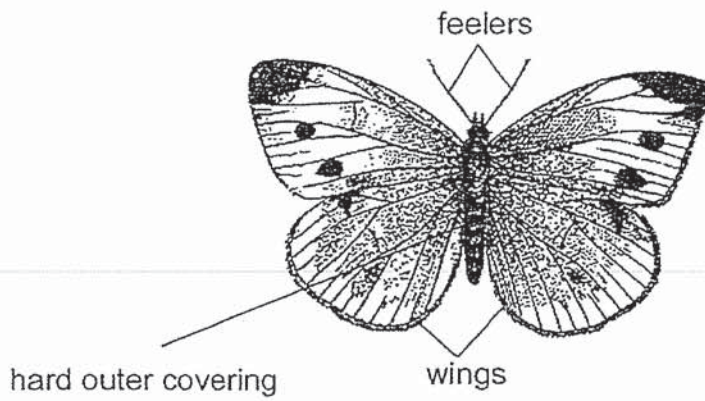

Bob said that animal P belongs to the same group as animal N because it also has wings.

- (d) Based only on the characteristics shown in the diagram above, explain why he is wrong. [1]

---

---

32. The diagram below shows a pot of plant.

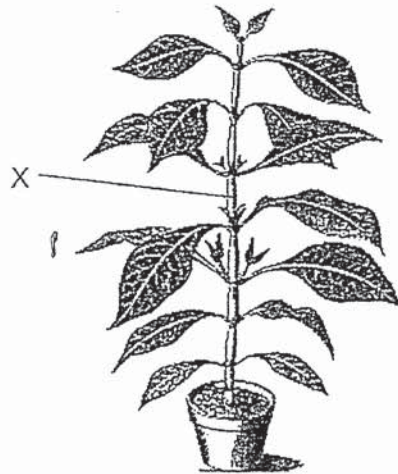

(a) State the function of part X. [1]

---

---

Penny bought two identical plants, S and T. She removed most of the leaves from plant S as shown below.



Plant T

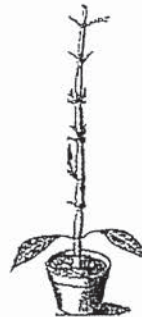

Plant S

She placed both plants in her garden and watered them daily.

(b) Which plant is more likely to grow better? Explain your answer. [2]

---

---

---

33. Study the diagram of the human digestive system below.

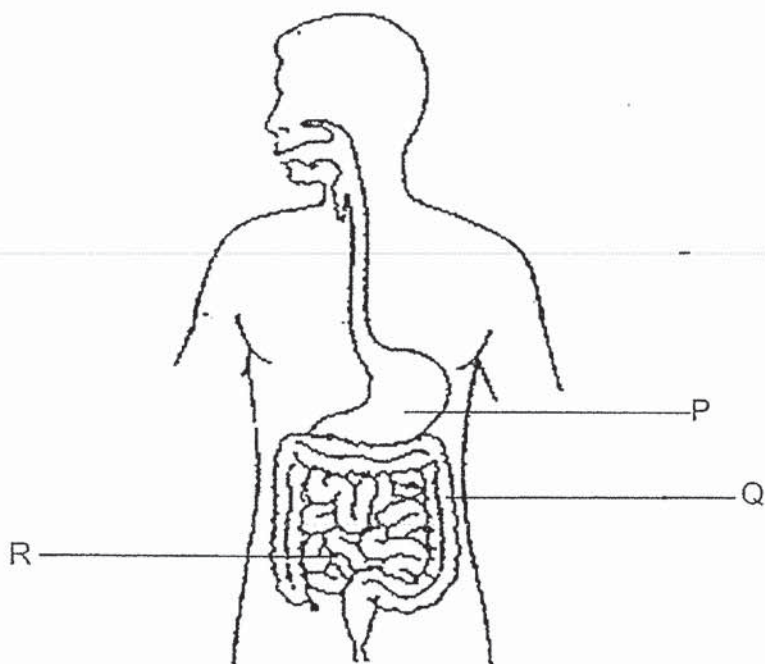

(a) Identify parts P and Q. [1]

Part P: \_\_\_\_\_

Part Q: \_\_\_\_\_

(b) **Name** the 3 parts of the human digestive system where digestive juices are produced. [1]

\_\_\_\_\_

(c) State two functions of part R. [2]

i) \_\_\_\_\_

\_\_\_\_\_

ii) \_\_\_\_\_

\_\_\_\_\_

34. Jim had four bar magnets of different sizes as shown below.

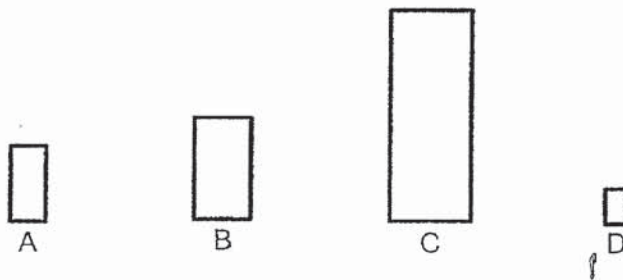

He took magnet A and placed one of its poles 1cm above a tray of steel clips. He recorded how many steel clips were attracted to it. He repeated the experiment with the other magnets and recorded his results in the table below.

Magnet	Number of steel clips attracted
A	7
B	11
C	3
D	5

(a) Which magnet has the strongest magnetic force of attraction? Explain your answer. [1]

---

---

(b) Give a reason why Jim used the poles of the magnets instead of the middle for his experiment. [1]

---

---

(c) Does the size of the magnets affect their magnetic strength? Explain your answer using the results from the experiment. [1]

---

---

Jim had a metal bar. He brought the bar close to the North pole of magnet B and the bar was attracted to the magnet. When he repeated the steps with the South pole of magnet B, the bar was also attracted to the magnet, as shown in the diagram below.

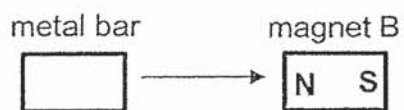

Jim concluded that the metal bar was a magnet.

- (d) Based on the properties of magnets, explain why Jim's conclusion was wrong. [1]

---

---



35. Joseph set up an experiment as shown below. When light from the torch passed through a hole in the cardboard, a light spot was formed on the screen. Positions A, B and C were the possible positions of the light spots formed on the screen.

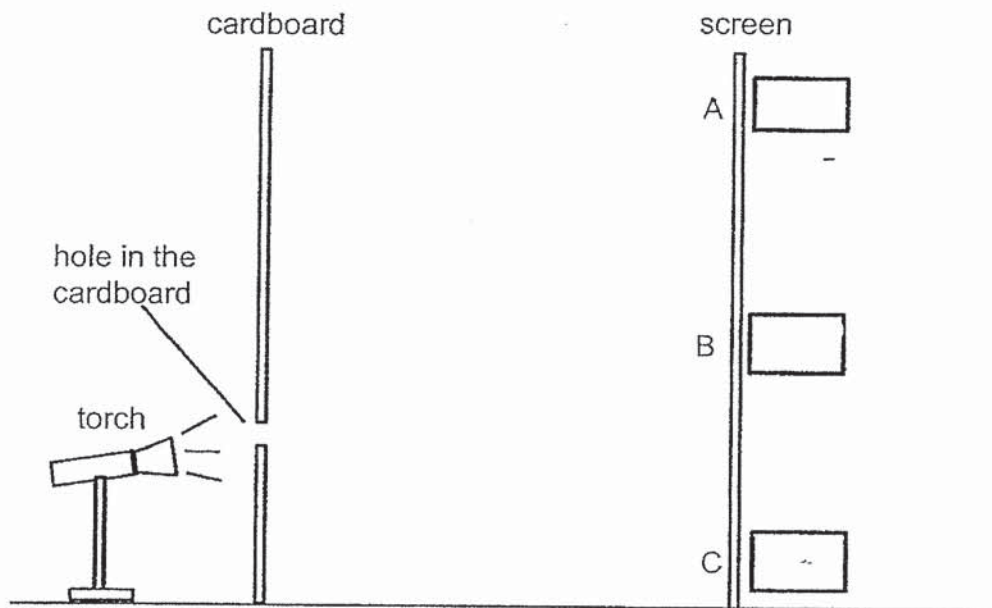

- (a) Based on the experiment above, put a tick (✓) in the box( A, B or C) that shows the correct position of the light spot. [1]

A clear plastic sheet was used to cover the hole in the cardboard.

- (b) Would Joseph still be able to see the light spot on the screen? Explain your answer. [1]

---



---

Joseph wanted a smaller light spot to be seen on the screen.

- (b) Using the same items above, suggest one change that Joseph could make to the experimental set up. [1]

---



---

36. Marcus placed a 20 cm pole A, at the centre of the basketball court from 8 a.m. to 6 p.m. on a sunny day. He measured the lengths of the shadows cast at different timings and recorded the results in the table below.

Time	Length of shadow of pole A (cm)
8 a.m.	90
10.30 a.m.	60
12 p.m.	10
3 p.m.	70
6 p.m.	120

- (a) Based on the results, state a possible length of the shadow of pole A at 4.30 p.m. [1]

---

- (b) Describe how the shadow of pole A was formed. [1]

---



---

Marcus then replaced pole A with pole B at the same position as pole A at the basketball court on another sunny day. Pole B is 8 cm long.

He observed that at a certain time of the day, the lengths of the shadows cast by poles A and B were the same.

- (c) The diagram below shows several positions of the Sun. Put a tick  in the correct position of the Sun that enables the above observation to be made. [1]

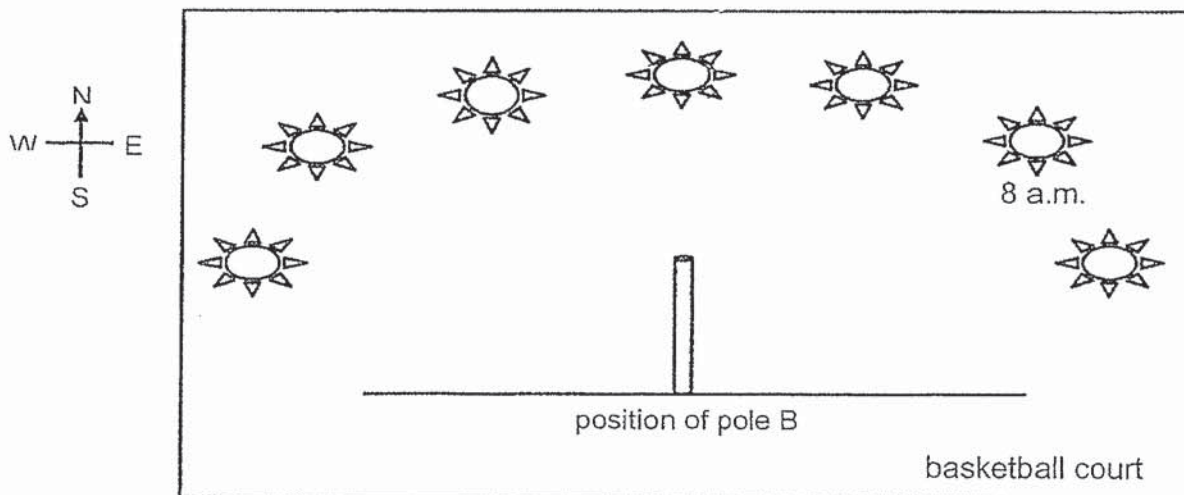



37. Sarah set up the experiment below to find out how the position of an object affect the size of the shadow cast. Object X was placed at three different positions away from the torch to cast a shadow on the screen as shown below.

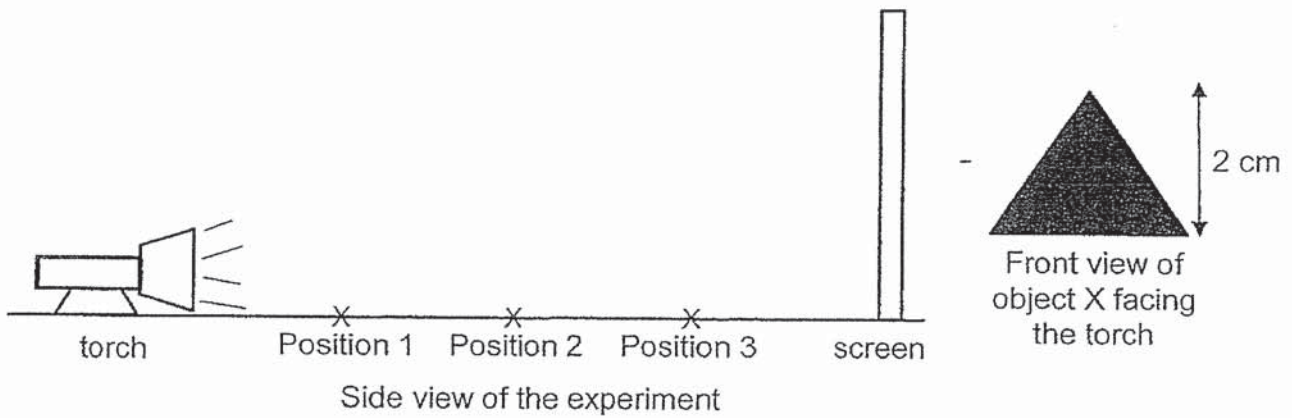

(a) **Draw** the shadows cast by the object in Position 1 and Position 3 in the box provided below. **State the height of each shadow.** [2]

Position 1	Position 3
------------	------------

(b) State the property of light that is needed for shadows to be formed. [1]

---



---

Sarah wanted to create a shadow of object X that was bigger than the original size. Object X was fixed at Position 2.

(c) Without changing the positions of the screen and object X, what should Sarah do to create a bigger shadow of object X? [1]

---



---

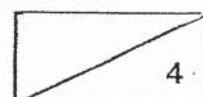

38. The flowchart below shows the properties of matters A,B and C.

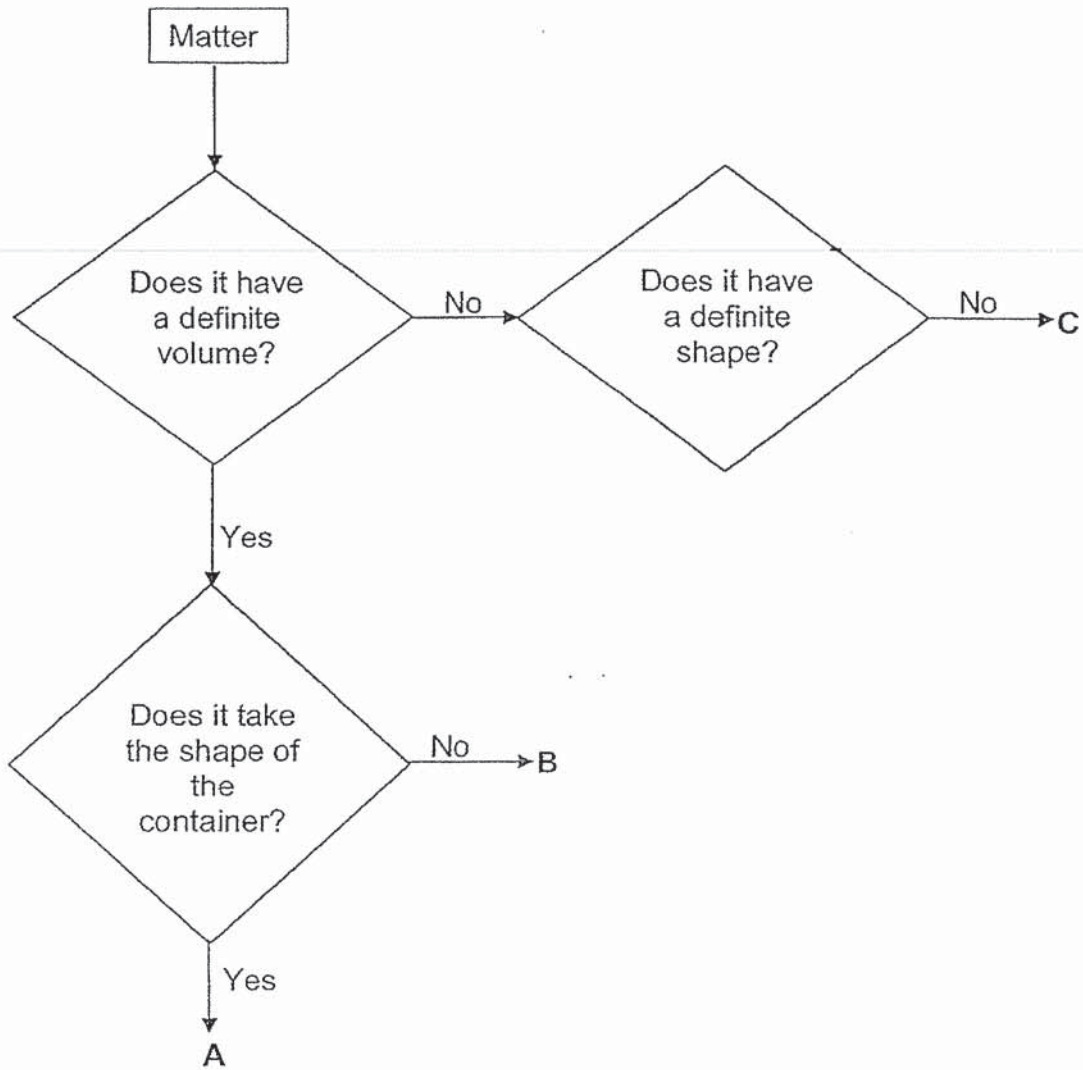

(a) State all the properties of matter B. [1]

---



---

(b) i) Fill in the table below by writing the states in which matters A and C are found at room temperature.

ii) Give an example for matters A and C. [2]

	(i) State	(ii) Example
Matter A		
Matter C		

39. Peter placed matter X into container 1 which was half-filled with water. He then placed the same matter X into container 2 which was also half-filled with water as shown in the diagrams below.

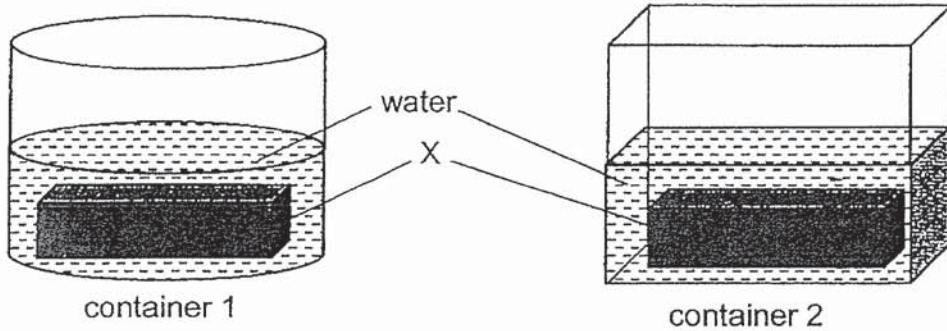

Peter noticed that the water level in both containers rise when matter X was placed in them.

- (a) State two properties of matter X based on the above observation. [2]

(i) \_\_\_\_\_

(ii) \_\_\_\_\_

Sarah filled tank A with sand to a height of 20 cm. Tank A has a height of 40 cm. She then poured all the water from tank B into tank A without any spillage.

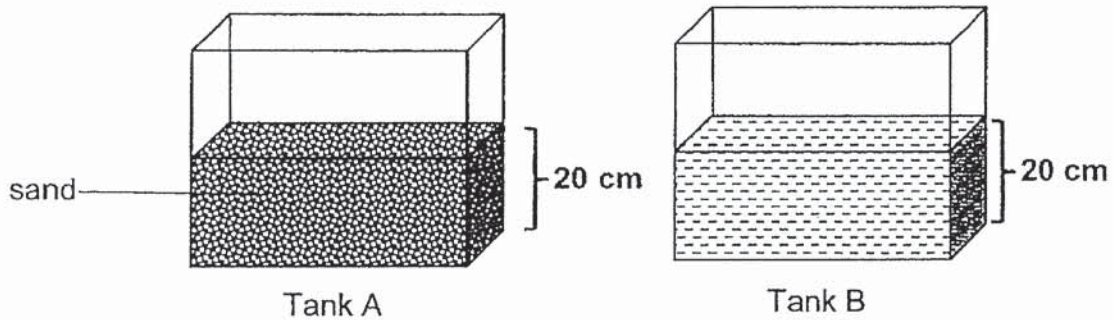

- (b)(i) Sarah observed that there were bubbles coming out from the sand as she poured the water into the container. Explain her observation. [1]

\_\_\_\_\_

\_\_\_\_\_

- (b)(ii) Sarah observed that the total height of water and sand in the tank A was less than 40 cm. Provide a reason for Sarah's observation. [1]

\_\_\_\_\_

\_\_\_\_\_

40. May Ling played with a toy paper tube at her birthday party as shown in diagram 1.

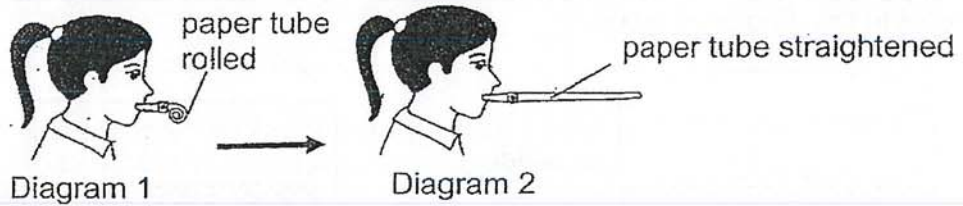

(a) What did May Ling do to the paper tube to straighten it as shown in diagram 2? [1]

\_\_\_\_\_

(b) State one property of matter that is shown in (a). [1]

\_\_\_\_\_

After the birthday party, May Ling poured some left-over orange juice into a glass bottle as shown in the diagram below.

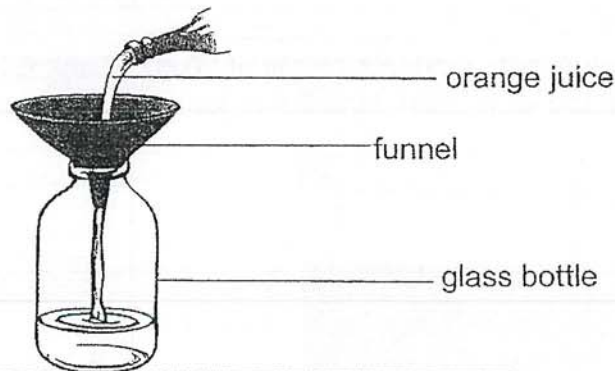

(c) May Ling observed that the orange juice flowed slowly into the glass bottle. Explain her observation. [1]

\_\_\_\_\_

\_\_\_\_\_

(d) Without making any changes to the glass bottle, state what May Ling could do to allow the orange juice to flow in more quickly into the glass bottle. Explain your answer. [2]

\_\_\_\_\_

\_\_\_\_\_

\_\_\_\_\_

~ End of Booklet B ~



## ANSWER KEY

YEAR : 2018  
LEVEL : PRIMARY 4  
SCHOOL : Nanyang SCHOOL  
SUBJECT : SCIENCE  
TERM : SA1

### SECTION A

Q1	3	Q2	3	Q3	3	Q4	3	Q5	2
Q6	2	Q7	1	Q8	2	Q9	3	Q10	2
Q11	2	Q12	1	Q13	2	Q14	2	Q15	3
Q16	4	Q17	3	Q18	4	Q19	2	Q20	4
Q21	2	Q22	2	Q23	2	Q24	1	Q25	4
Q26	3	Q27	2	Q28	4				

### SECTION B

Q29 (a)

	Graph A	Graph B
Young Plant		✓
Toy Doll	✓	

(b) Living things can grow.

(c)

(i) The toy car is not a living thing because she pushed it to move.

(ii) The toy car is not a living thing because it does not need air, food, and water.

Q30 (a) (i) and (ii) and S bears flowers.

(b) Plant R lives on land while P does not.

(c) Fern, Sunflower

Q31 (a) They both have wings.

(b) Animal M has hair as an outer covering while Animal N has feathers as an outer covering.

(c) Mammals, Birds

(d) He is wrong as Animal P has three body parts and an exoskeleton.

Q32 (a) It gives the plant support, so that it can receive maximum sunlight.

(b) Plant T because it has more leaves to make food while Plant S has lesser leaves to make food.

Q33 (a) Stomach, Large intestine

(b) Mouth, stomach and small intestine.

(c)(i) Part R is absorption of nutrients and minerals from food.

(ii) It digests nutrients in Part R.

Q34 (a) B as it attracted the most amount of steel clips.

(b) The magnetic strength of the magnet is strongest at its poles.

(c) No, as B was one of the smaller magnets but managed to attract the most amount of steel clips.

(d) Jim is wrong because if the magnets like poles are facing each other they will repel.

Q35 (a) B

(b) Joseph will still be able to see because the clear plastic sheet allows most light to pass through.

(c) He can move the cardboard closer to the torch or move the torch closer to the cardboard.

Q36 (a) 85cm

(b) The sunlight was facing at pole A but it blocked the light causing a shadow to be formed.

(c)

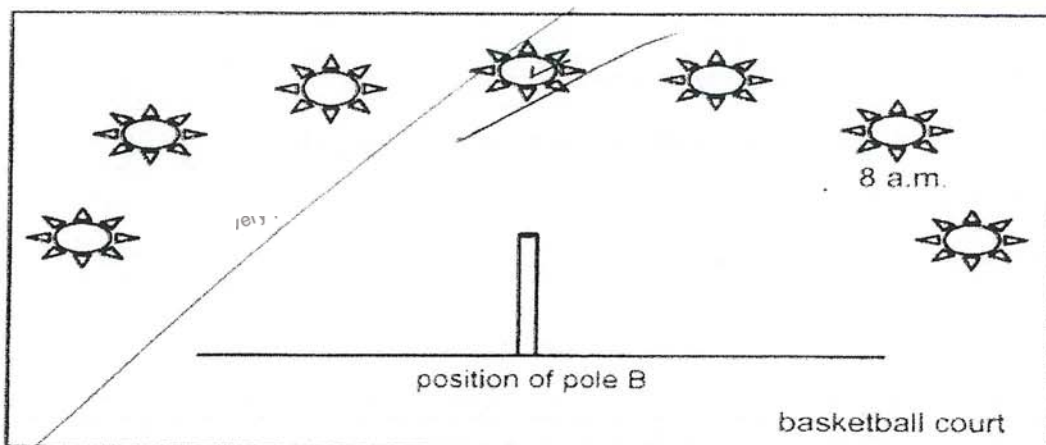

Q37 (a)

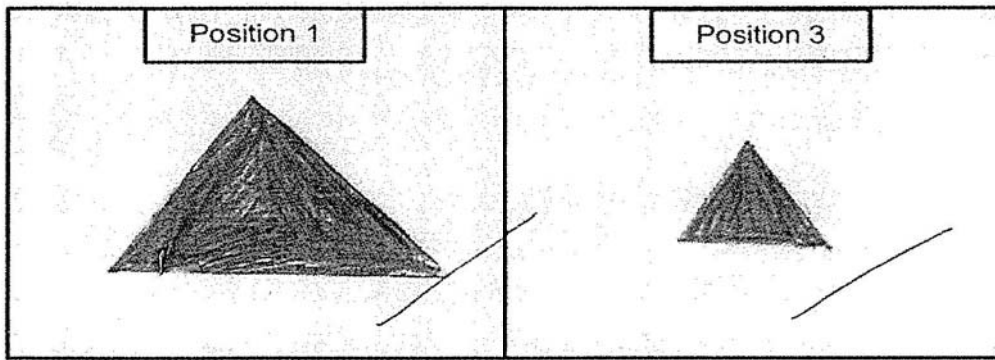

(b) Light needs to be blocked so a shadow can be formed.

(c) She should move the torch closer to object X.

Q38 (a) Matter B has a definite volume and has a definite shape.

(b) liquid, Water

gas, oxygen

Q39 (a)(i) Matter has mass

(ii) Matter X occupies space

(b)(i) There were air spaces in between, the sand when water was poured into it they became air bubbles.

(ii) There are air spaces in between the sand and the water will occupy the space.

Q40 (a) She blew air into it.

(b) Air occupy space

(c) There is air occupying the space in the glass bottle and the funnel blocking the air from entering or escaping from the glass bottle.

(d) She can take out the funnel and pour the orange juice directly in the bottle.

3  
END.