



HENRY PARK PRIMARY SCHOOL  
 2022 SEMESTRAL ASSESSMENT 1  
 MATHEMATICS  
 PRIMARY 4

Name: \_\_\_\_\_ (     ) Parent's Signature \_\_\_\_\_

Class: Primary 4 \_\_\_\_\_

Duration of Paper: 1 h 45 min

Marks:

Section A (MCQ)	20
Section B (Open-Ended)	50
Section C (Problem Sums)	30
<b>Total</b>	<b>100</b>



**SECTION A: Multiple-Choice Questions (20 marks)**

Questions 1 to 10 carry 2 mark each.

For each question, four options are given. One of them is the correct answer.  
Make your choice (1, 2, 3 or 4) and shade your answer in the Optical Answer Sheet.

1. What is the value of digit 6 in 42 650?

- (1) 6  
(2) 60  
(3) 600  
(4) 6000

( )

2. What is the product of 2109 and 3?

- (1) 73  
(2) 703  
(3) 6327  
(4) 6357

( )

3. The figure below is made up of identical squares.  
What fraction of the figure is shaded?

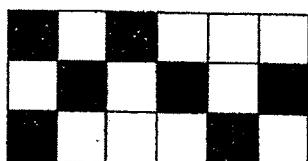

- (1)  $\frac{7}{11}$   
(2)  $\frac{7}{18}$   
(3)  $\frac{11}{18}$   
(4)  $\frac{11}{7}$

( )

4. The rectangle below has a length of 8 m and a breadth of 5 m. What is the perimeter of the rectangle?

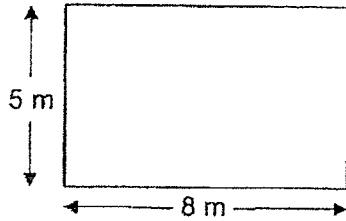

- (1) 13 m  
 (2) 26 m  
 (3) 32 m  
 (4) 40 m
- ( )
5. In the figure below, how many of the marked angles are greater than  $90^\circ$ ?

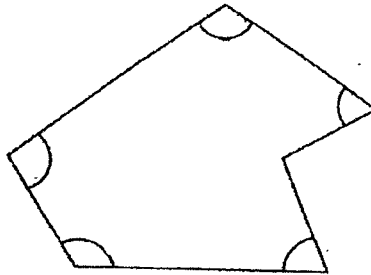

- (1) 1  
 (2) 2  
 (3) 3  
 (4) 4
- ( )

6. Which of the following figure(s) is/are symmetric?

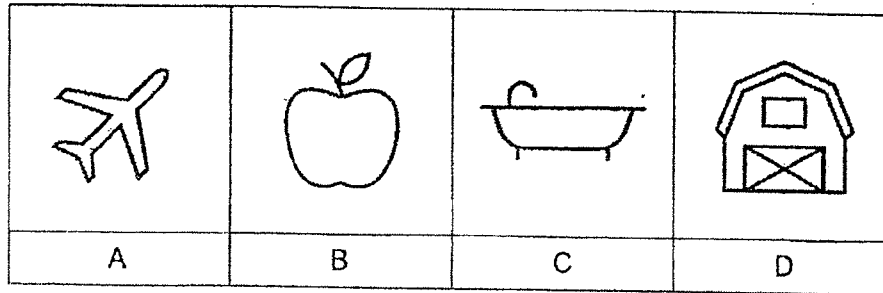

- (1) A, B and C only
- (2) A and D only
- (3) B and C only
- (4) D only ( )
7. Lucy bought a storybook for \$10.95 and a file for \$2.70. She gave the cashier \$20. How much change did she receive?
- (1) \$6.35
- (2) \$7.45
- (3) \$7.65
- (4) \$8.65 ( )
8. The capacity of a fish tank is 5 l 20 ml. It contains 340 ml of water. How much more water is needed to fill up the fish tank completely?
- (1) 180 ml
- (2) 860 ml
- (3) 4680 ml
- (4) 4860 ml ( )

9. Jacob started working on his project at 10.45 a.m. At 1 p.m., he took an hour break and then continued working on his project until 3.30 p.m. How much time did he spend working on his project?

(1) 3 h 45 min

(2) 4 h 45 min

(3) 5h 45 min

(4) 7 h 15 min

( )

10. The figure below is made up of two squares, E and F. Each side of square F is three times as long as each side of square E. What fraction of the figure is shaded?

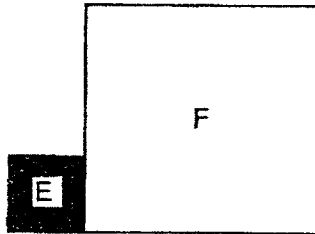

(1)  $\frac{1}{3}$

(2)  $\frac{1}{4}$

(3)  $\frac{1}{9}$

(4)  $\frac{1}{10}$

( )

**SECTION B: Open-Ended Questions (50 marks)**

Questions 11 to 35 carry 2 marks each. Show your working clearly and write your answers in the spaces provided. For questions which require units, give your answers in the units stated.

Do not  
write in  
this space

11. Round 86 594 to the nearest hundred.

Ans: \_\_\_\_\_

12. What is the sum of 65 thousands and 49 tens?

Ans: \_\_\_\_\_

13. Complete the number pattern below.

3240, 3263, 3286, \_\_\_\_\_, 3332, 3355

Ans: \_\_\_\_\_

14. Find the first common multiple of 6 and 8.

Do not  
write in  
this space

Ans: \_\_\_\_\_

15. Express  $\frac{27}{6}$  as a mixed number in its simplest form.

Ans: \_\_\_\_\_

16. How many eighths are there in  $3\frac{5}{8}$ ?

Ans: \_\_\_\_\_



17. Find the value of  $\frac{1}{5} + \frac{7}{10} + \frac{2}{5}$ .  
Express your answer as a mixed number in its simplest form.

Do not  
write in  
this space

Ans: \_\_\_\_\_

18. What is the size of  $\angle WAZ$ ?

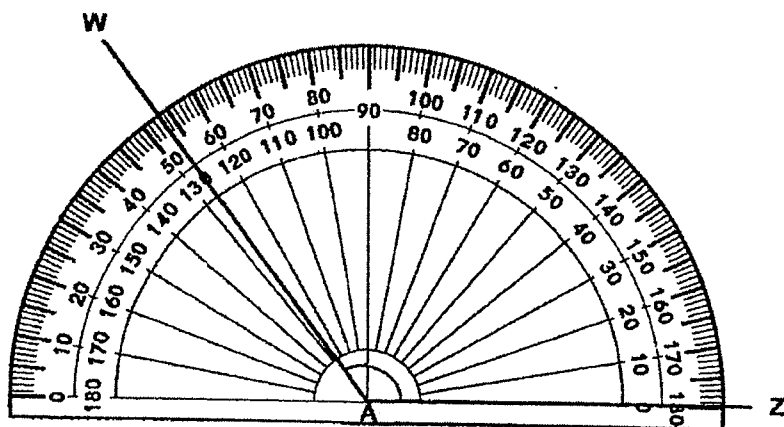

Ans: \_\_\_\_\_

19.  $\angle RXN$  is  $100^\circ$ . Join the marked end point X of line XN to the correct dot to get the required angle. Label the angle.



Do not write in this space

20. Shade 2 more squares to form a symmetric figure with XY as the line of symmetry.

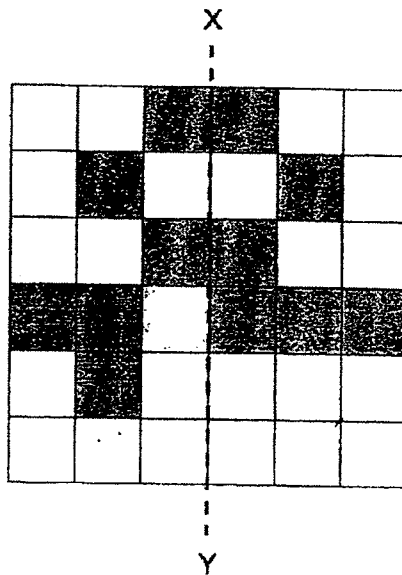

Use the bar graph below to answer questions 21 and 22.

The bar graph below shows the amount of money four students saved in a week.

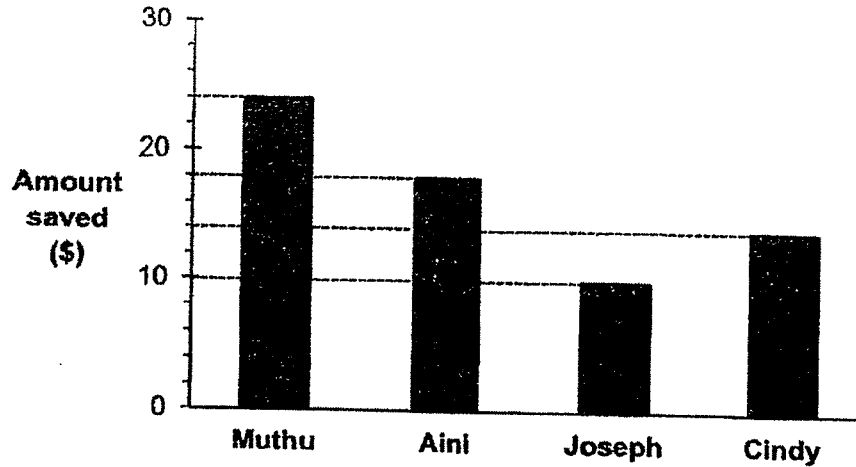

21. What was the total amount of money saved by Aini and Cindy?

Ans: \$ \_\_\_\_\_

22. After Muthu had given Joseph \$4, how much more money would Muthu have than Joseph?

Ans: \$ \_\_\_\_\_

Do not  
write in  
this space

23. A number is a multiple of 3. It is also a factor of 42. It is between 14 and 27. What is the number?

Do not  
write in  
this space

Ans: \_\_\_\_\_

24. After Julia donated half of her savings to charity and spent \$124 on a toy, she had \$102 left. How much savings did Julia have at first?

Ans: \$ \_\_\_\_\_

25. Devi bought 3 m of ribbon. She used  $\frac{2}{7}$  m of the ribbon to decorate some presents. How many metres of ribbon did she have left? Express your answer as a mixed number.

Ans: \_\_\_\_\_ m

26. Mr Tan had some apples. After selling  $\frac{1}{5}$  of his apples at a fair, he had 304 apples left. How many apples did he have at first?

Do not  
write in  
this space

Ans: \_\_\_\_\_

27. Siti and Ahmad spent a total of \$200.25 at the supermarket. Siti spent \$102.90. How much more did Siti spend than Ahmad?

Ans: \$ \_\_\_\_\_

28. Ben paid \$630 for a suit and a pair of shoes. The suit cost 5 times as much as the pair of shoes. How much did the pair of shoes cost?

Ans: \$ \_\_\_\_\_

29. 8 bins are placed at an equal distance apart along a straight road as shown below. The distance between every two bins is 36 m. What is the distance between the first bin and the last bin?

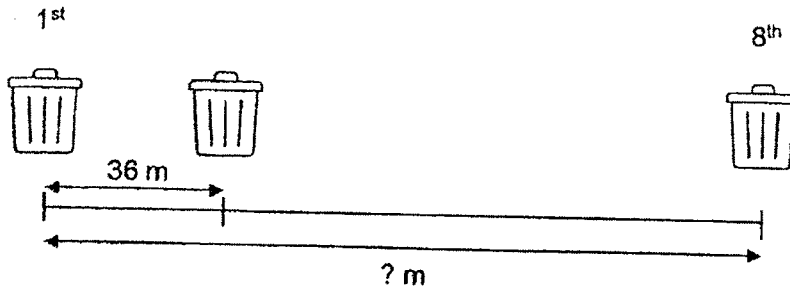

Do not  
write in  
this space

Ans: \_\_\_\_\_ m

30. Mrs Bala took 5h 15 min to drive from Kuala Lumpur to Singapore. She arrived at Singapore at 4.05 p.m. What time did Mrs Bala leave Kuala Lumpur for Singapore?

Ans: \_\_\_\_\_ a.m.

31. Tina is standing at the Ticket Booth and facing East. She makes a  $225^\circ$  turn in a clockwise direction. What would she be facing?

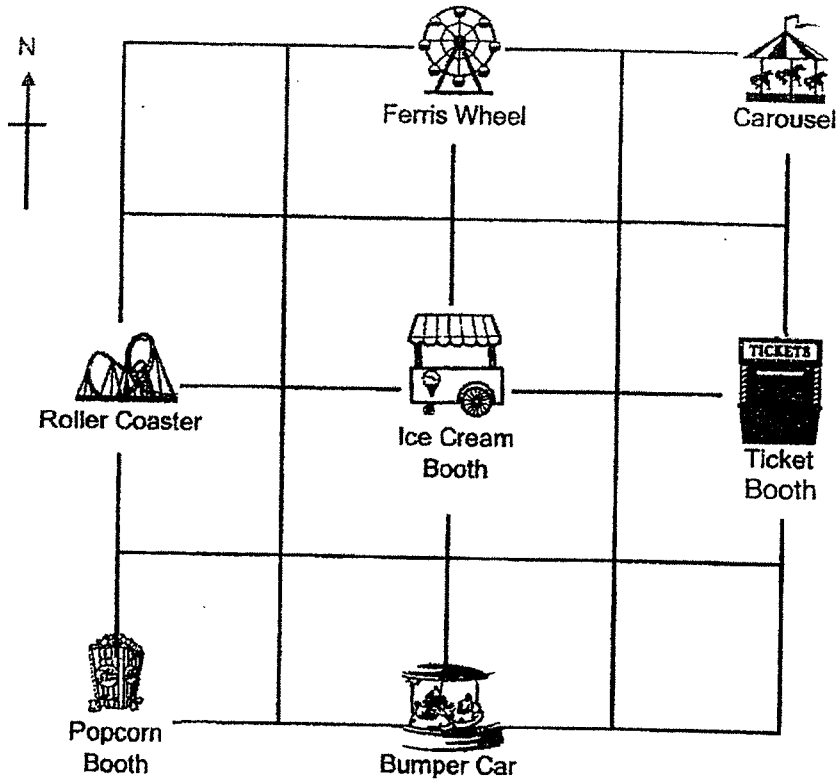

Ans: \_\_\_\_\_



32. In the figure below, PQRS is a square and QWXY is a rectangle. Find  $\angle YQR$ .

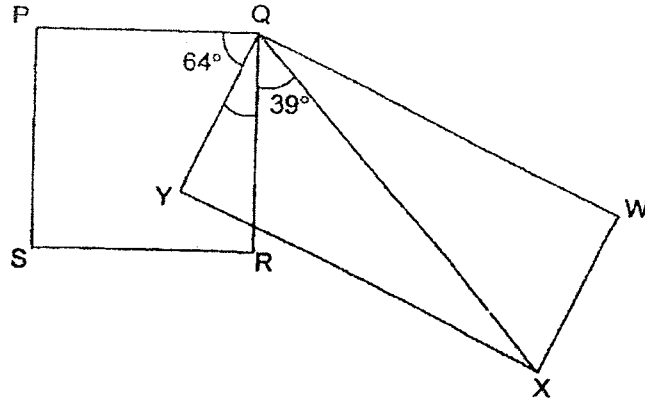

Do not write in this space

Ans: \_\_\_\_\_

33. Form the greatest possible 4-digit number that can be divided by 5 without a remainder. Each digit can be used only once.

8

3

9

1

0

Ans: \_\_\_\_\_



34. The fractions shown below are arranged in decreasing order. The numerator of the second fraction has been smudged by ink. What is the missing numerator?

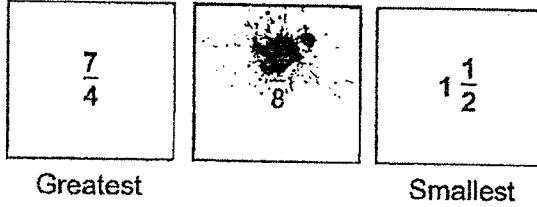

Do not write in this space

Ans: \_\_\_\_\_

35. Complete the symmetric figure with PQ as the line of symmetry. Shade the figure.

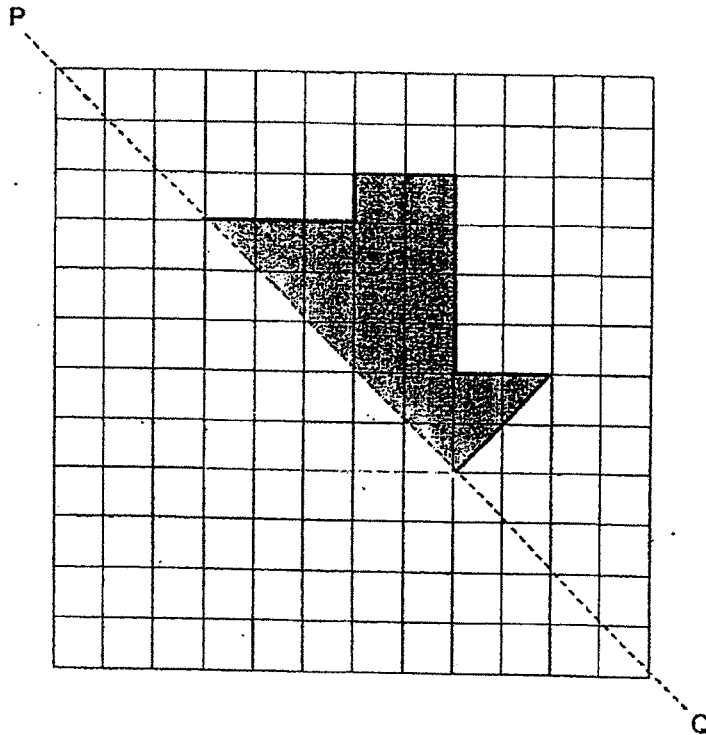

NAME: \_\_\_\_\_ CLASS: Primary 4 \_\_\_\_\_

**SECTION C: Problem Sums (30 marks)**

For questions 36 to 43, show your working clearly and write your answers in the spaces provided. The number of marks available is shown in the brackets [ ] at the end of each question or part-question.

36. Kelly bought 150 candies. She packed the candies into 18 bags.  
There were 7 candies in each bag. How many candies were left unpacked?

Working

Ans: \_\_\_\_\_ [3]

37. There were some animals in a farm.  $\frac{1}{3}$  of them were chickens,  $\frac{2}{9}$  of them were cows and the remaining animals were goats.

- (a) What fraction of the animals were goats?  
Express your answer in its simplest form.
- (b) Given that there were 116 goats in the farm, how many animals were there altogether in the farm?

Working

Ans: (a) \_\_\_\_\_ [1]

(b) \_\_\_\_\_ [3]

38. Ali, Ben and Charlie baked some cookies for charity. Charlie baked 5490 cookies. Charlie baked 6 times as many cookies as Ben. Ali baked 1360 more cookies than Ben. How many cookies did they bake in all?

Working

Ans: \_\_\_\_\_ [4]

39. Louis made purple paint by mixing red and blue paint together.  
He used  $\frac{5}{6}$  l of red paint. He used  $\frac{1}{4}$  l less blue paint than red paint.

- (a) How much blue paint did he use?  
Express your answer in its simplest form.
- (b) How much purple paint did Louis make?  
Express your answer as mixed number in its simplest form.

Working

Ans: (a) \_\_\_\_\_ [2]

(b) \_\_\_\_\_ [2]

40. A rectangular piece of card, ABCD, was folded along PR as shown below.

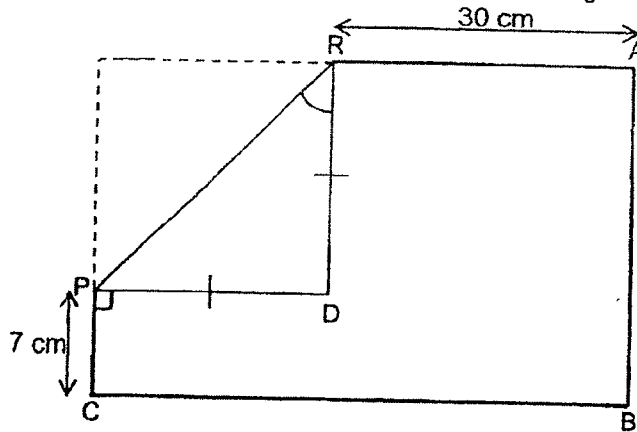

The length of RD is equal to the length of PD. RD is two times as long as PC and PC is 7 cm.

- (a) Find  $\angle PRD$ .
- (b) Find the area of rectangle ABCD before it was folded.

Working

Ans: (a) \_\_\_\_\_ [1]

(b) \_\_\_\_\_ [3]



41. Matt, Nathan and Larry had a total of 386 marbles. Matt had 28 marbles more than Nathan. Larry had 4 times as many marbles as Matt. How many marbles did Matt have?

Working

Ans: \_\_\_\_\_ [3]

42. Timothy paid a total of \$12 200 for 5 identical laptops and 3 identical mobile phones. Each laptop cost \$720 more than each mobile phone. What was the cost of one mobile phone?

Working

Ans: \_\_\_\_\_ [4]



43. In a bakery, muffins were only sold in boxes. A box of 4 big muffins cost \$11 and a box of 6 mini muffins cost \$8.

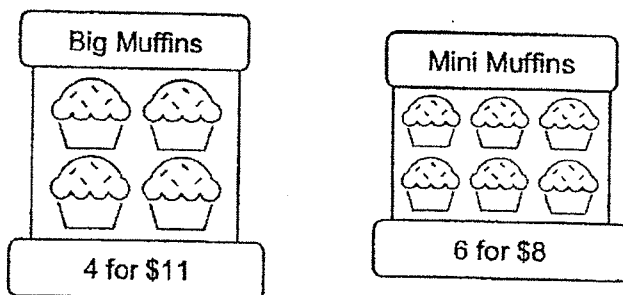

Jenny bought the same number of big muffins and mini muffins. What was the least possible amount of money she would have paid for the muffins?

Ans: \_\_\_\_\_ [4]

Setters: Ms Hazlina and Ms Siti Fasihah

Page 23

END OF PAPER



YEAR : 2022  
 LEVEL : PRIMARY 4  
 SCHOOL : HENRY PARK PRIMARY SCHOOL  
 SUBJECT : MATHEMATICS  
 TERM. : SEMESTRAL ASEESMENT 1

(BOOKLET A)

Q1	3	Q2	3	Q3	2	Q4	2	Q5	3
Q6	2	Q7	1	Q8	3	Q9	1	Q10	4

(BOOKLET B)

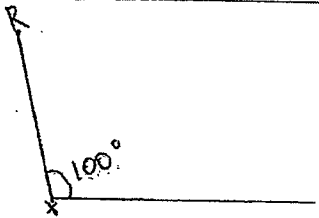
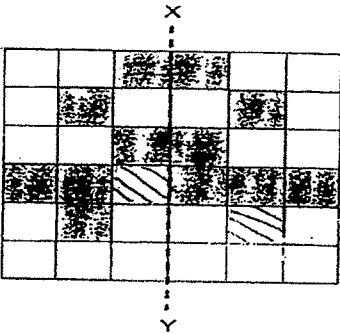
Q11	86600
Q12	65490
Q13	3309
Q14	24
Q15	$4\frac{1}{2}$
Q16	$8 \times 3 = 24$ $24 + 5 = 29$
Q17	$\frac{2}{10} + \frac{7}{10} + \frac{4}{10} = \frac{13}{10}$ $= 1\frac{3}{10}$
Q18	$127^\circ$
Q19	
Q20	
Q21	$18 + 14 = \$32$
Q22	$20 - 14 = \$6$
Q23	$42 = 2 \times 21$
Q24	$124 + 102 = 226$

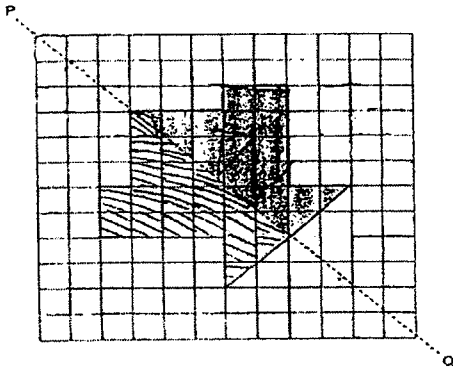
	$226 \times 2 = \$452$
Q25	$3m = \frac{21}{7}m$ $\frac{21}{7} - \frac{2}{7} = \frac{19}{7}$ $= 2\frac{5}{7}m$
Q26	$\frac{4}{5} = 304$ $\frac{1}{5} = 304 \div 4$ $= 76$ $\frac{5}{5} = 76 \times 5$ $= 380$
Q27	$A = \$200.25 - \$102.90$ $= \$97.35$ $\$102.90 - 97.35 = \$5.55$
Q28	$6u = 630$ $1u = 630 \div 6$ $= \$105$
Q29	<b>No. of gaps</b> $= 8 - 1 = 7$ $7 \times 36 = 252m$
Q30	10.50 a.m.
Q31	Ferris Wheel
Q32	$90 - 64 = 26^\circ$
Q33	$9831 \div 5 = 1966 R1$ $9830 \div 5 = 1966$ 9830
Q34	13
Q35	
Q36	$7 \times 18 = 126$ $150 - 126 = 24$
Q37	a) $\frac{1}{3} = \frac{3}{9}$ $\frac{3}{9} + \frac{2}{9} = \frac{5}{9}$ $\frac{9}{9} - \frac{5}{9} = \frac{4}{9}$ b) $4u = 116$ $1u = 116 \div 4$ $= 29$

	$9u = 29 \times 9$ $= 261$	
Q38	$6u = 5490$ $1u = 5490 \div 6$ $= 915$ $8u = 915 \times 8$ $= 7320$ $7320 + 1360 = 8680$	
Q39	$a) \frac{1}{4} = \frac{6}{24}$ $\frac{5}{6} = \frac{20}{24}$ $\frac{6}{24} - \frac{6}{24} = \frac{14}{24}$ $= \frac{7}{12}L$ $b) \frac{7}{12} + \frac{10}{12} = 1\frac{5}{12}L$	
Q40	$a) PRD = 90 \div 2$ $= 45^\circ$ $b) 7 + 14 = 21$ $14 + 30 = 44$ $44 \times 21 = 924cm^2$	
Q41	$5 \times 28 = 140$ $6u = 386 - 140$ $= 246$ $1u = 246 \div 6$ $= 41$ $41 + 28 = 69$	
Q42	$720 \times 5 = 3600$ $8u = 12200 - 3600$ $= 8600$ $1u = 8600 \div 8$ $= \$1075$	
Q43	$12 \div 4 = 3$ $3 \times 11 = 33$ $12 \div 6 = 2$ $2 \times 8 = 16$ $16 + 33 = \$49$	

3  
END

0 2

0