

SA1



NAN HUA PRIMARY SCHOOL

MID YEAR EXAMINATION – 2021

PRIMARY FOUR

MATHEMATICS

INSTRUCTIONS TO CANDIDATES

1. Write your name, register number and class in the space provided.
2. Do not turn over the page until you are told to do so.
3. Follow all instructions carefully.
4. Answer all questions.
5. Shade your answers in the Optical Answer Sheet (OAS) provided for Questions 1 - 20.

Marks Obtained

Section	Maximum Marks	Actual Marks
A	40	
B	40	
C	20	
Total	100	

Name : _____ ()

Class : Pr 4M _____

Date : 17 May 2021

Duration: 1 h 45 min

Parents' Signature: _____

Section A: Multiple Choice Questions

Questions 1 to 20 carry 2 marks each.

For each question, four options are given. One of them is the correct answer.

Make your choice (1, 2, 3 or 4) and shade your answer on the Optical Answer Sheet.

(40 marks)

-
1. Which of the following are the numbers arranged from the smallest to the greatest?
- | | (smallest) | | (greatest) |
|-----|------------|---|-----------------|
| (1) | 67 230 | , | 68 203 , 68 023 |
| (2) | 68 023 | , | 67 230 , 68 203 |
| (3) | 67 230 | , | 68 023 , 68 203 |
| (4) | 68 023 | , | 68 203 , 67 230 |
2. Which of the following numbers is 20 000 when rounded to the nearest hundred?
- (1) 19 891
- (2) 19 949
- (3) 19 951
- (4) 20 091
3. Which of the following is not a factor of 18?
- (1) 6
- (2) 2
- (3) 3
- (4) 4
4. The common multiple of 9 and 4 is _____.
- (1) 13
- (2) 27
- (3) 32
- (4) 36

5. What is the size of $\angle ABC$?

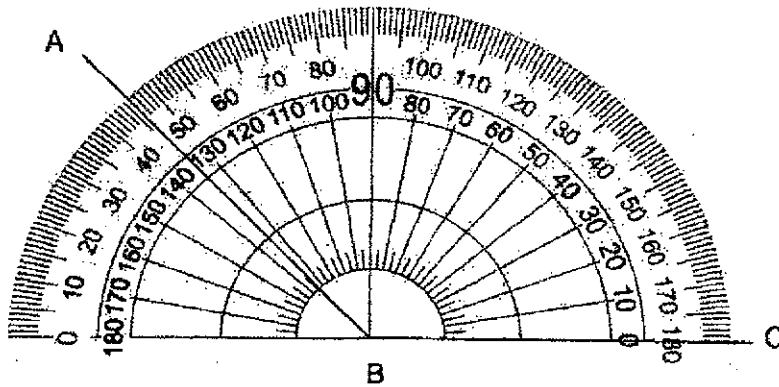

- (1) 46°
 (2) 54°
 (3) 134°
 (4) 146°
6. Which of the following is the same as 40 km 10 m?

- (1) 4010 m
 (2) 40 100 m
 (3) 40 010 m
 (4) 40 001 m

7. $\frac{4}{6} = \frac{10}{\square}$

What is the missing number in the box?

- (1) 12
 (2) 14
 (3) 15
 (4) 16

8. Mr Lim left work at the time shown below. He arrived home at 3.25 p.m. How long did he take to travel home?

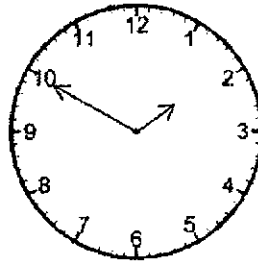

- (1) 1 h 15 min
 (2) 1 h 25 min
 (3) 1 h 35 min
 (4) 2 h 15 min
9. Express $6\frac{3}{9}$ as an improper fraction.

- (1) $\frac{27}{9}$
 (2) $\frac{33}{9}$
 (3) $\frac{54}{9}$
 (4) $\frac{57}{9}$

10. A movie at the cinema started at 10.30 a.m. David arrived at the cinema 10 minutes after the movie had started. He left once the movie ended. He was in the cinema for 2 h 12 min. At what time did the movie end?

- (1) 12.28 p.m.
 (2) 12.32 p.m.
 (3) 12.42 p.m.
 (4) 12.52 p.m.

11. The table below shows the price of tickets for a carnival.

Type of ticket	Weekday	Weekend
Adult	\$20.45	\$25.45
Child (12-year-old and below)	\$12.65	\$17.65

Mr Tan and his 10-year-old son went to the carnival on Saturday. How much did their tickets cost altogether?

- (1) \$33.10
 (2) \$38.10
 (3) \$38.65
 (4) \$43.10

12. What fraction of the square is shaded?

- (1) $\frac{1}{3}$
 (2) $\frac{1}{4}$
 (3) $\frac{1}{5}$
 (4) $\frac{1}{6}$

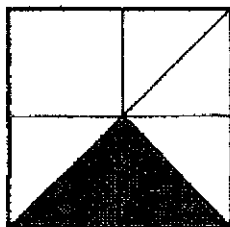

13. Find the value of $\frac{1}{2} + \frac{2}{7}$

- (1) $\frac{5}{13}$
 (2) $\frac{5}{42}$
 (3) $\frac{16}{21}$
 (4) $\frac{11}{14}$

14. Matthew was standing at point X. He made a 135° anticlockwise turn and ended up facing the Parade Square. Which direction was he facing at first?

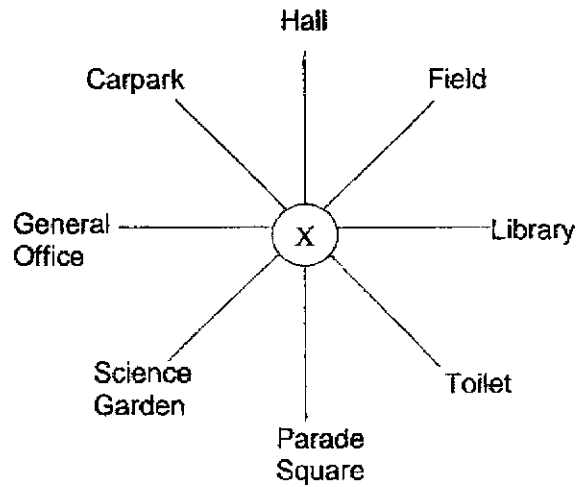

- (1) Carpark
 (2) Toilet
 (3) Science Garden
 (4) Field
15. What is the length of the square?

- (1) 32 cm
 (2) 16 cm
 (3) 8 cm
 (4) 4 cm

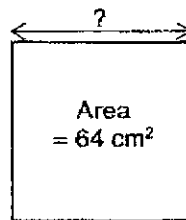

16. Mr Lee and his wife earn \$5250 each year. His wife earns \$780 more than him. How much does his wife earn each year?

- (1) \$2235
 (2) \$2625
 (3) \$3015
 (4) \$3405

17. A baker had some muffins. $\frac{2}{7}$ of the muffins were sold. There were 70 muffins left.
How many muffins did the baker have at first?

- (1) 50
- (2) 98
- (3) 175
- (4) 245

18. Which of the following letters has more than 1 line of symmetry?

X D M N

- (1) X
 - (2) D
 - (3) M
 - (4) N
19. Katy bought 1 kg of strawberries. She gave $\frac{1}{3}$ kg to her sister and $\frac{3}{5}$ kg to her brother. She ate the remaining strawberries. How much strawberries did Katy eat?

- (1) $\frac{1}{15}$ kg
- (2) $\frac{4}{15}$ kg
- (3) $\frac{11}{15}$ kg
- (4) $\frac{14}{15}$ kg

The bar graph below shows the number of books donated by some Primary 4 students.

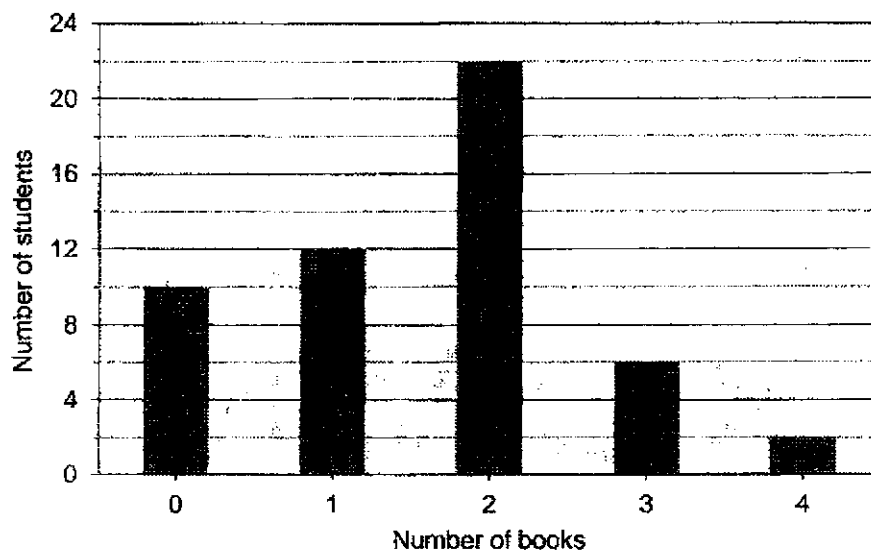

20. What is the total number of books donated?

- (1) 42
- (2) 52
- (3) 82
- (4) 92

Section B: Open-ended Questions

Questions 21 to 40 carry 2 marks each. Show your working clearly and write your answers in the spaces provided. For questions which require units, give your answers in the units stated.

(40 marks)

21. Write the missing number in the number pattern below.

22 728 , 22 528 , 22 328 , 22 128 , _____

Ans:

22. What is the remainder when 3062 is divided by 7?

Ans:

23. Find the product of 467 and 38.

Ans:

24. List all the common factors of 32 and 56.

Ans:

25. Express $\frac{14}{56}$ in its simplest form.

Ans:

26.

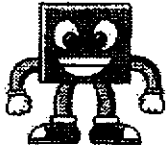

I am a 2-digit number.
The sum of my two digits is 9.
I am a common multiple of 7 and 3.
What number am I?

Ans:

27. Arrange the following fractions from the smallest to greatest.

$$\frac{4}{3}, \quad \frac{11}{12}, \quad \frac{10}{9}$$

_____ , _____ , _____
(smallest) , _____ , (greatest)

28. A bag and 2 identical pouches cost \$35.50. 1 such bag and 1 such pouch cost \$27.95. What is the price of 1 pouch?

Ans: \$

29. There were some cookies. $\frac{3}{8}$ of them were chocolate cookies and the rest were almond cookies. There were 36 more almond cookies than chocolate cookies. How many almond and chocolate cookies were there altogether?

Ans:

30. The difference between two fractions is $\frac{4}{5}$. The smaller fraction is $\frac{1}{4}$. What is the greater fraction?

Ans:

31. The perimeter of the square is the same as the rectangle. What is the length of the rectangle?

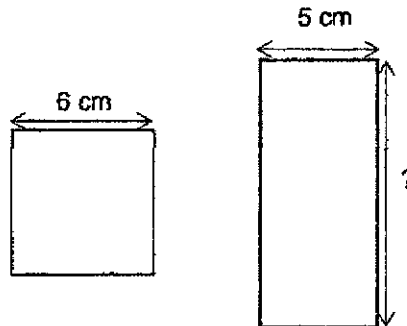

Ans: cm

32. Draw and label $\angle CBA$ such that $\angle CBA$ is 75° .



33. Complete the symmetric figure below with XY as the line of symmetry.

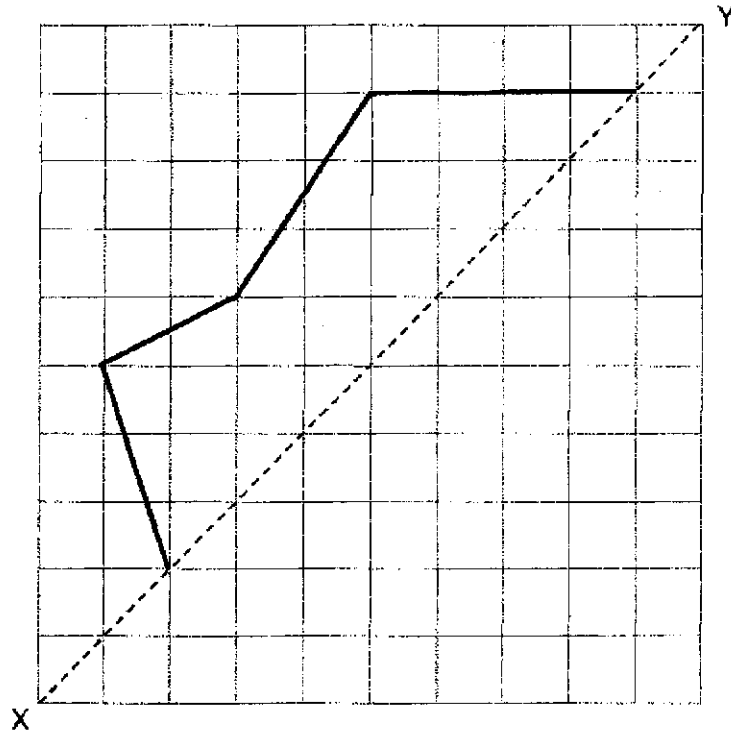

34. The mass of the watermelon is 3 times the mass of a mango. The mass of a mango is twice the mass of an apple. The mass of the mango is 210 g. What is the total mass of the watermelon, mango and apple?

Ans: g

35. Mrs Goh bought some oranges from the market. She received 8 free oranges.
How much did she pay for the oranges? Express your answer in cents.



Ans: ¢

36. Figure A: I have 4 sides and 2 pairs of parallel lines.
Figure B: I have 4 equal sides and 4 right angles.

Each statement below is either true, false or not possible to tell from the information given. For each statement, put a tick (✓) in the correct column.

	Properties	True	False	Not possible to tell
(a)	Figure A is a rectangle.			
(b)	Figure B is a square.			

37. In the grid, draw and label a line KL that is parallel to line MN.

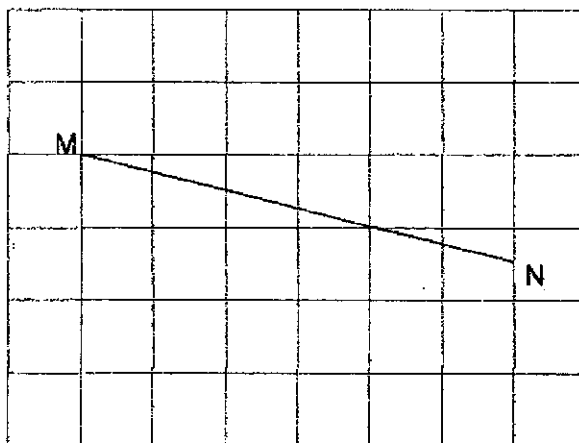

Tim was given \$400 to spend from January to June.

The graph below shows the amount of money Tim had left at the end of each month.

Study the graph carefully and answer questions 38 to 40.

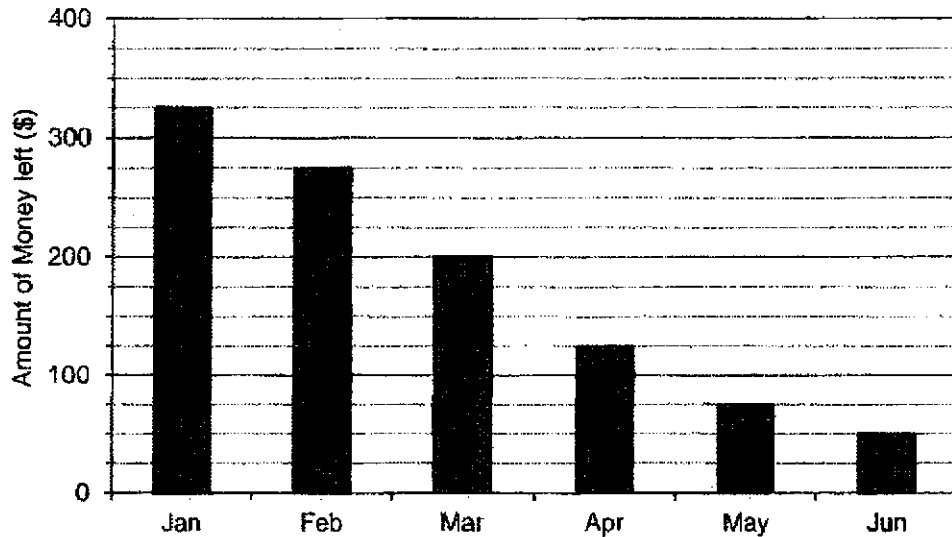

38. How much money did Tim have left at the end of May?

Ans: \$

39. How much money did Tim spend from January to April?

Ans: \$

40. At the end of June, Tim used the remaining money to buy an equal number of notebooks and pencils. Each notebook cost \$4 and each pencil cost \$1. How many notebooks did he buy?

Ans:

Section C

For each of the following questions, show your working clearly and write your answers in the space provided. The number of marks available is shown in brackets [] at the end of question or part-question. (20 marks)

41. The bar graph below shows the amount of money Mrs Tan earned each day.

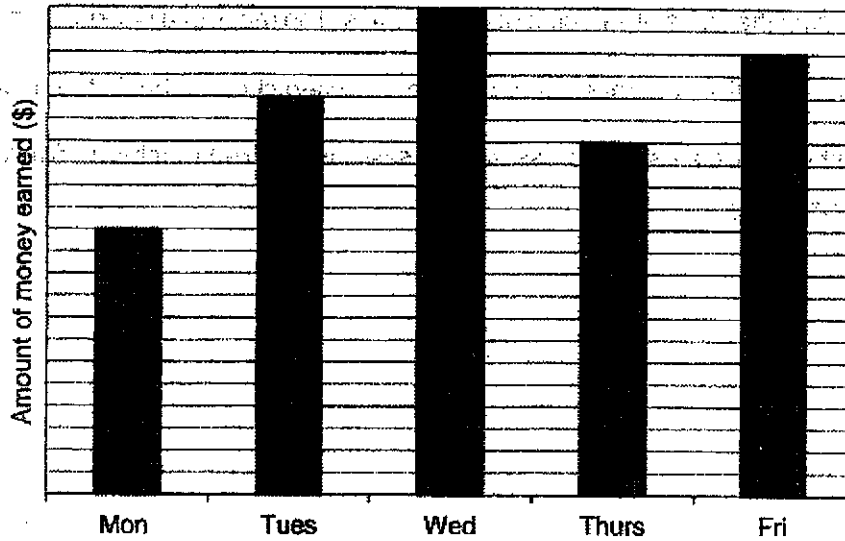

Mrs Tan was paid for 6h of work on Monday. What was the total number of hours she worked from Monday to Friday?

Ans: _____ [3m]

42. The mass of a packet of biscuits is $\frac{8}{9}$ kg. The mass of the packet of biscuits is $\frac{1}{2}$ kg more than the mass of a packet of potato chips. The mass of a packet of chocolates is $\frac{2}{3}$ kg more than the mass of the packet of potato chips. What is the mass of the packet of chocolates? (Express your answer as a mixed number or fraction in its simplest form)

Ans: _____ [3m]

43. Ali and Bala received an equal amount of pocket money. Ali spent $\frac{1}{2}$ of his money and saved the rest. Bala spent \$12.35 and saved the rest. In the end, Bala saved \$8.65 more than Ali. How much money did each of them have at first?

Ans: _____ [3m]

44. Miss Chua had 12 packets of sweets. Each packet had 27 sweets. She kept 118 sweets for herself and packed the remaining sweets into bags of 6. What is the least number of bags she needs?

Ans: _____ [4m]

45. Caili had twice as many stamps as David. David gave Caili 18 stamps. Caili then had 92 more stamps than David. How many stamps did they have altogether?

Ans: _____ [4m]

46. Mary had a string that was 82 cm long. She cut it into 4-cm and 2-cm strips. She had a total of 26 strips. How many 4-cm strips were there?

Ans: _____ [3m]

End of paper ©

NHPS MYE – 2021
P4 MATHEMATICS

Section A

Q1	Q2	Q3	Q4	Q5	Q6	Q7	Q8	Q9	Q10
3	3	4	4	3	3	3	3	4	4
Q11	Q12	Q13	Q14	Q15	Q16	Q17	Q18	Q19	Q20
4	2	4	1	3	3	2	1	1	3

Section B

Qn	Answer	Marks
21)	21 928	A2
22)	3	A2
23)	17 746	A2
24)	1,2,4,8	A2
25)	$\frac{1}{4}$	A2
26)	63	
27)	$\frac{11}{12}, \frac{10}{9}, \frac{4}{3}$	A2
28)	$\$35.50 - \$27.95 = \$7.55$	M1 A1
29)	$5u - 3u = 2u = 36$ $1u = 36 \div 2 = 18$ $8u = 18 \times 8 = 144$	M1 A1
30)	$1 - \frac{4}{5} - \frac{1}{4}$ $= 1 - \frac{16}{20} - \frac{5}{20} = \frac{21}{20}$ OR $1\frac{1}{20}$	M1 A1
31)	$6 \times 4 = 24$ (P of square) $24 - 10 = 14$ (2L of rectangle) $14 \div 2 = 7$ OR $6 \times 4 = 24$ (P of square) $24 \div 2 = 12$ (1L + 1B of rectangle) $12 - 5 = 7$	M1 A1 M1 A1

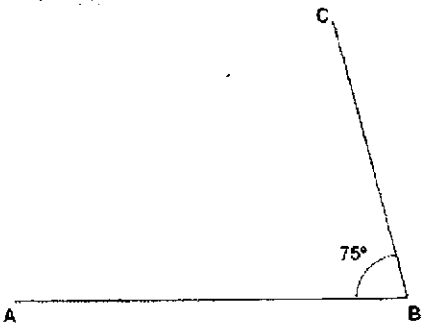
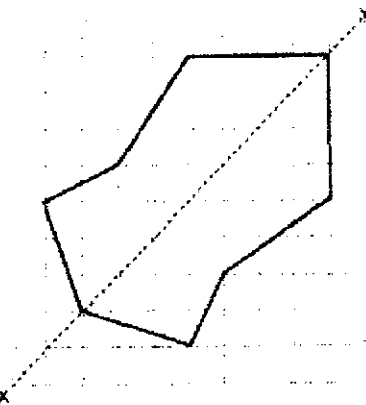
32)		A2															
33)		A2															
34)	<p>1u = 210 ÷ 2 = 105 (apple) 9u = 105 × 9 = 945</p> <p>OR</p> <p>210 ÷ 2 = 105 (apple) 210 × 3 = 630 (watermelon) 630 + 105 + 210 = 945</p> <p>OR</p> <p>210 × 4 = 840 (watermelon and mango) 840 + 105 = 945</p>	M1 A1 M1 A1 M1 A1															
35)	<p>8 ÷ 2 = 4 (4 groups of 5+2 oranges) 4 × 5 = 20 20 × 50 ¢ = 1000¢</p>	M1 A1															
36)	<table border="1" data-bbox="295 1601 949 1769"> <thead> <tr> <th></th> <th>Properties</th> <th>True</th> <th>False</th> <th>Not possible to tell</th> </tr> </thead> <tbody> <tr> <td>(a)</td> <td>Figure A is a rectangle.</td> <td></td> <td></td> <td>✓</td> </tr> <tr> <td>(b)</td> <td>Figure B is a square.</td> <td>✓</td> <td></td> <td></td> </tr> </tbody> </table>		Properties	True	False	Not possible to tell	(a)	Figure A is a rectangle.			✓	(b)	Figure B is a square.	✓			A1 A1
	Properties	True	False	Not possible to tell													
(a)	Figure A is a rectangle.			✓													
(b)	Figure B is a square.	✓															
37)	Possible parallel lines	A2															

38)	$25 \times 3 = 75$	M1 A1
39)	$400 - 125 = 275$ OR $75 + 50 + 75 + 75 = 275$ OR $25 \times 11 = 275$	M1 A1
40)	$4 + 1 = 5$ (1 group of notebook and pencil) $50 \div 5 = 10$	M1 A1

Section C

Qn	Answer	Marks
41)	12 gaps \rightarrow 6h 2 gap \rightarrow 1h OR 1 gap \rightarrow $\frac{1}{2}$ h 6h (Men) + 9h (Tues) + 11h (Wed) + 8h (Thurs) + 10h (Fri) = 44h Ans: 44h	M1 M1 A1
42)	$\frac{8}{9} - \frac{1}{2} = \frac{16}{18} - \frac{9}{18} = \frac{7}{18}$ $\frac{7}{18} + \frac{2}{3} = \frac{7}{18} + \frac{12}{18} = \frac{19}{18} = 1\frac{1}{18}$ OR $\frac{8}{9} - \frac{1}{2} + \frac{2}{3} = \frac{16}{18} - \frac{9}{18} + \frac{12}{18} = 1\frac{1}{18}$ Ans: $1\frac{1}{18}$ kg	M1 M1 A1 M2 A1

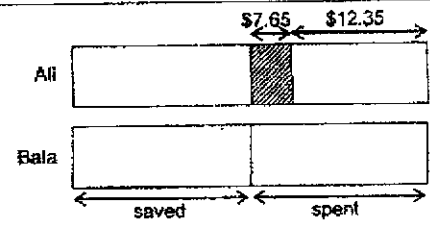
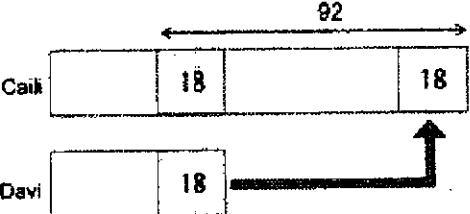
43)	 <p> $12.35 + 8.65 = 21$ $21 \times 2 = 42$ Ans: \$42 </p>	M1 M1 A1
44)	<p> $12 \times 27 = 324$ (total sweets) $324 - 118 = 206$ (remaining sweets) $206 \div 6 = 34$ R2 (groups of 6) $34 + 1 = 35$ (least number of bags) Ans: 35 </p>	M1 M1 M1 A1
45)	 <p> $1u = 92 - 18 - 18 = 56$ $3u = 56 \times 3 = 168$ OR $92 - 18 = 74$ $74 - 18 = 56$ $56 \times 3 = 168$ OR $18 \times 2 = 36$ $92 - 36 = 56$ $56 \times 3 = 168$ OR $18 \times 2 = 36$ $92 - 36 = 56$ $56 - 18 = 38$ $38 \times 2 = 76$ $76 + 92 = 168$ OR $18 \times 3 = 54$ $92 - 54 = 38$ $38 \times 3 = 114$ $114 + 54 = 168$ Ans: 168 </p>	M2 M1 A1 M1 M1 M1A1 M1 M1 M1A1 M1 M1 M1A1

46) **Guess and Check Method:**

Number of 4-cm strips	Number of 2-cm strips	Total length of 4-cm strips	Total length of 2-cm strips	Total length	Check
13	13	13×4 $= 52$	13×2 $= 26$	$52 + 26$ $= 78$	————— *
12	14	12×4 $= 48$	14×2 $= 28$	$48 + 28$ $= 76$	*
14	12	14×4 $= 56$	12×2 $= 24$	$56 + 24$ $= 80$	*
15	11	15×4 $= 60$	11×2 $= 22$	$60 + 22$ $= 82$	————— ✓

There are 15 4-cm strips. ————— A1

Award M1 for any first guess reflecting the correct total length of 4-cm and 2-cm strips even if the answer is not obtained.

Assumption Method:
Assume there are 26 2-cm strips.
 $26 \times 2 = 52$
 $82 - 52 = 30$ (M1)
 $4 - 2 = 2$
 $30 \div 2 = 15$ (M1)
 There are 15 4-cm strips. (A1)

OR
Assume there are 26 4-cm strips.
 $26 \times 4 = 104$
 $104 - 82 = 22$ (M1)
 $4 - 2 = 2$
 $22 \div 2 = 11$
 $26 - 11 = 15$ (M1)
 There are 15 4-cm strips. (A1)

