

PAYA LEBAR METHODIST GIRLS' SCHOOL (PRIMARY)
END-OF-YEAR EXAMINATION 2020
PRIMARY FOUR
MATHEMATICS
Paper 1

Name: _____ ()

Class: Primary 4 _____

Date: 30 Oct 2020

Total Time for Sections A, B and C: 1 hour 45 minutes

INSTRUCTIONS TO CANDIDATES

1. Do not turn over this page until you are told to do so.
2. Follow all the instructions carefully.
3. Answer all questions.
4. Shade your answers in the Optical Answer Sheet (OAS) provided.
5. All the figures in this paper are not drawn to scale unless stated otherwise.

	Marks Obtained / Maximum Marks
SECTION A	32
SECTION B	40
SECTION C	28
TOTAL	100

Questions 1 to 16 carry 2 marks each. For each question, four options are given. One of them is the correct answer. Make your choice (1, 2, 3 or 4). Shade the correct oval (1, 2, 3 or 4) on the Optical Answer Sheet. (32 marks)

1. In which of the following numbers does the digit 6 stand for 6000?

(1) 2564

(2) 4825

(3) 5246

(4) 6524

()

2. Which of the following fractions is in its simplest form?

(1) $\frac{3}{6}$

(2) $\frac{4}{12}$

(3) $\frac{6}{10}$

(4) $\frac{8}{9}$

()

3. Which of the following decimals is represented by letter A in the number line?

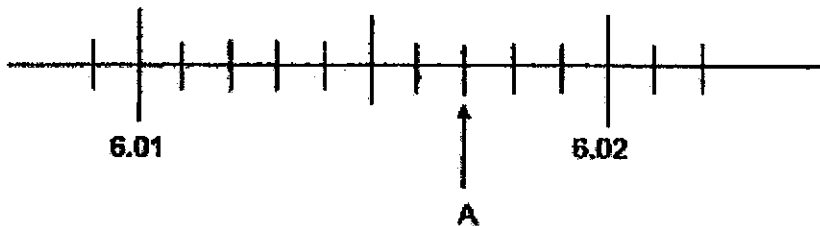

(1) 6.017

(2) 6.023

(3) 6.052

(4) 6.057

()

4. 3 and 4 are factors of _____.

(1) 15

(2) 16

(3) 24

(4) 25

()

5. Which one of the following has $\frac{1}{5}$ of the figure shaded?

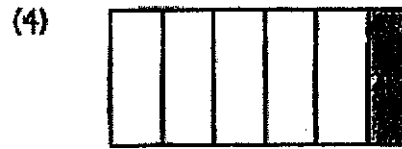
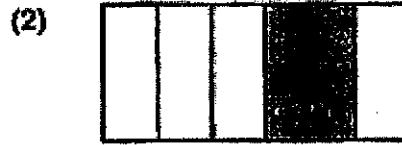
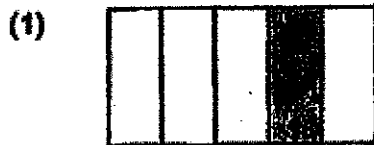

()

6. The figure shown is made up of a square S of side 2 cm and a rectangle R with breadth 4 cm. What is the length of the rectangle?

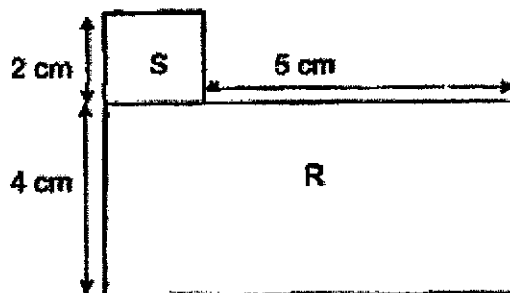

(1) 9 cm

(2) 7 cm

(3) 6 cm

(4) 5 cm

()

7. The bar graph below shows the number of pizzas a shop sold in the past 5 months.

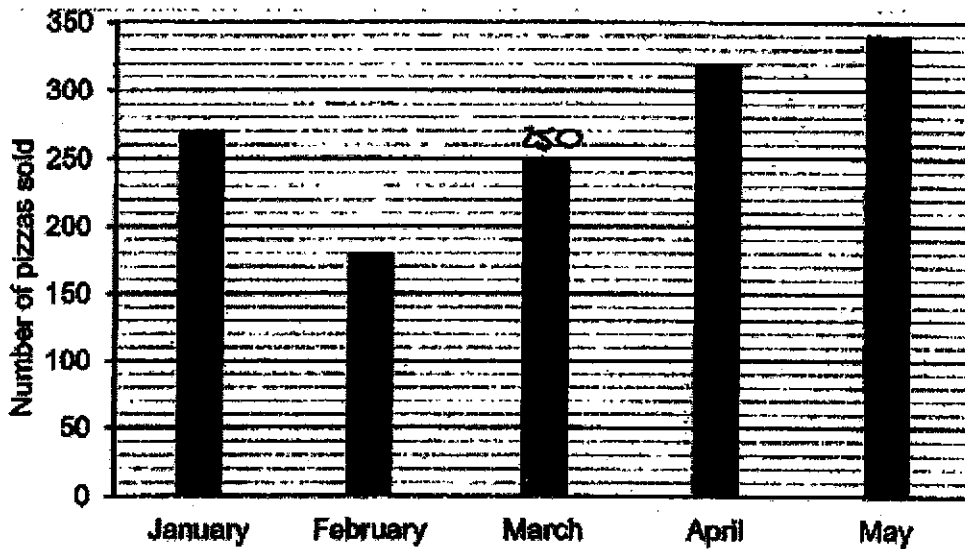

In which month did the shop sell 70 more pizzas than in March?

- (1) January
 - (2) February
 - (3) April
 - (4) May
- ()

8. Hui Hui went to the library every 3 days. Pin Pin went to the library every 4 days. When would they next meet if they first met at the library on 7 March?

March						
Mon	Tue	Wed	Thurs	Fri	Sat	Sun
		1	2	3	4	5
6	7	8	9	10	11	12
13	14	15	16	17	18	19
20	21	22	23	24	25	26
27	28	29	30	31		

- (1) 10 March
 - (2) 11 March
 - (3) 14 March
 - (4) 19 March
- ()

9. What is the missing number in the box below?

$$7\frac{3}{5} = \frac{\boxed{18}}{5}$$

(1) 21 (2) 26

(3) 35 (4) 38

()

10. Express $1\frac{9}{10}$ as a decimal.

(1) 0.09 (2) 0.9

(3) 1.09 (4) 1.9

()

11. P, Q and R are three points on a map. P is west of Q and $\angle PQR$ is 135° . In what direction is R from Q?

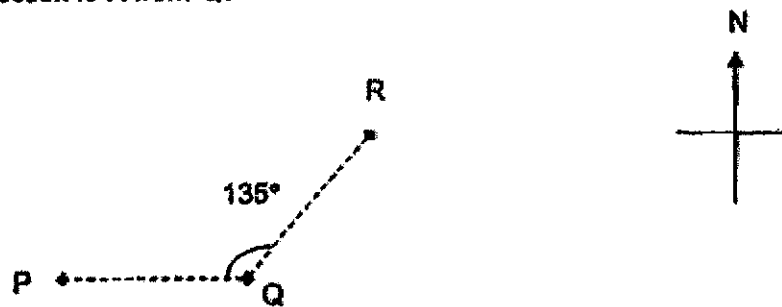

(1) North-east (2) North-west

(3) South-east (4) South-west

()

12. Divide 6 by 7.

Round your answer to the nearest tenth.

(1) 0.8

(2) 0.9

(3) 1.1

(4) 1.2

()

13. The figure below is made up of a rectangle ABEF and a square BCDE. The length FE is 3 times the length ED. The square has an area of 16 cm^2 . Find the perimeter of rectangle ACDF.

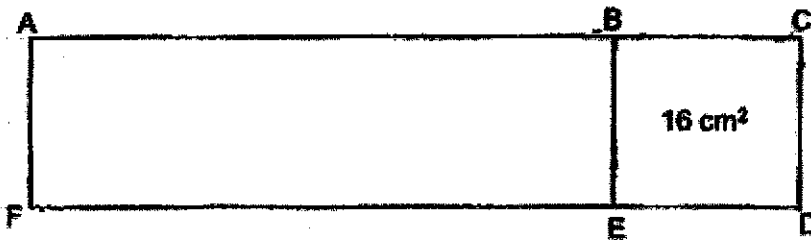

(1) 32 cm

(2) 35 cm

(3) 40 cm

(4) 64 cm

()

14. The graph below shows the height of a plant recorded every Sunday over 5 weeks.

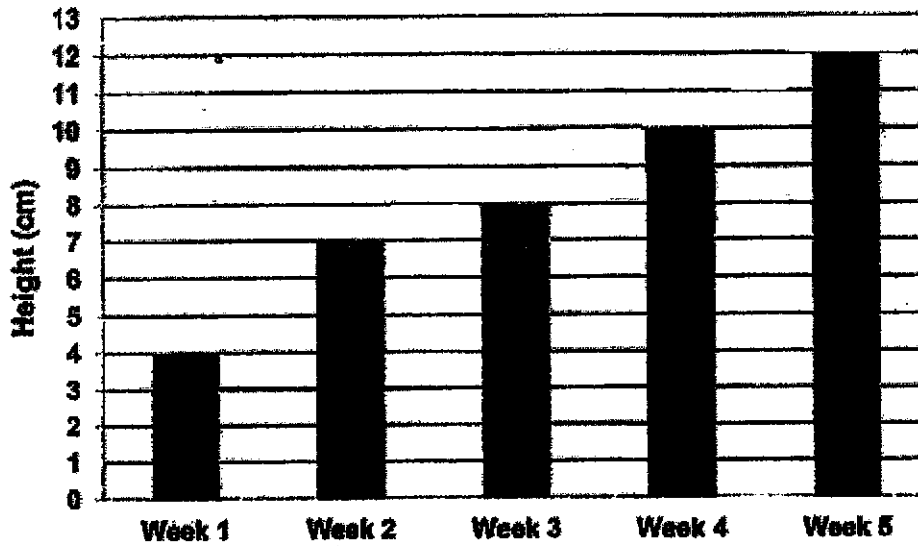

In which 1-week period was there the smallest increase in the height of the plant?

- (1) Week 1 and Week 2 (2) Week 2 and Week 3
 (3) Week 3 and Week 4 (4) Week 4 and Week 5 ()

15. How many of the letters below have at least one line of symmetry?

N O R T H

- (1) 1 (2) 2
(3) 3 (4) 4 ()
16. Minah had \$60 more than Priya at first. Then Priya gave \$6 to Minah. In the end, Minah had 4 times as much money as Priya. How much money did Priya have at first?

- (1) \$30 (2) \$24
(3) \$22 (4) \$18 ()

End of Booklet A

PAYA LEBAR METHODIST GIRLS' SCHOOL (PRIMARY)
END-OF-YEAR EXAMINATION 2020
PRIMARY FOUR
MATHEMATICS
Paper 2

Name : _____ ()

Class : Primary 4 _____

Date : 30 Oct 2020

Total Time for Sections A, B and C: 1 hour 45 minutes

INSTRUCTIONS TO CANDIDATES

1. Do not turn over this page until you are told to do so.
2. Follow all the instructions carefully.
3. Answer all questions.
4. All the figures in this paper are not drawn to scale unless stated otherwise.

	Marks Obtained / Maximum Marks	
SECTION B	/	40
SECTION C	/	28
TOTAL	/	68

SECTION B

Questions 17 to 36 carry 2 marks each. Write your answers in the spaces provided.
For questions which require units, give your answers in the units stated.

(40 marks)

Do not write
in this space

17. What number is 10 more than 8998?

Ans: _____

18. $\frac{2}{3} = \frac{6}{\square}$

What is the missing number in the box?

Ans: _____

19. Write 4 thousandths as a decimal.

Ans: _____

20. $1190 \times 5 =$ _____

Do not write
in this space

Ans: _____

21. $\frac{1}{4} + \frac{3}{8} =$ _____

Ans: _____

22. Round 10.68 to the nearest whole number.

Ans: _____

23. What is the remainder when 1020 is divided by 7?

Ans: _____

24. $6.08 + 3 =$ _____

Ans: _____

25. In the figure below, name the smallest angle.

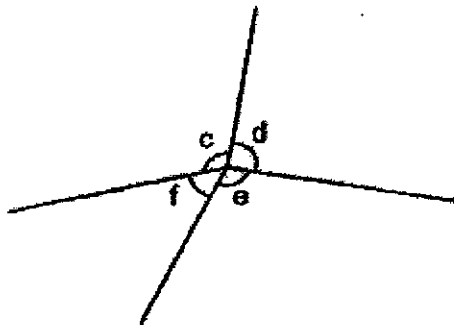

Ans: \angle _____

26. The bar graph below shows how Sue spent her money.
The amount of money spent on transport has not been drawn.

Do not write
in this space

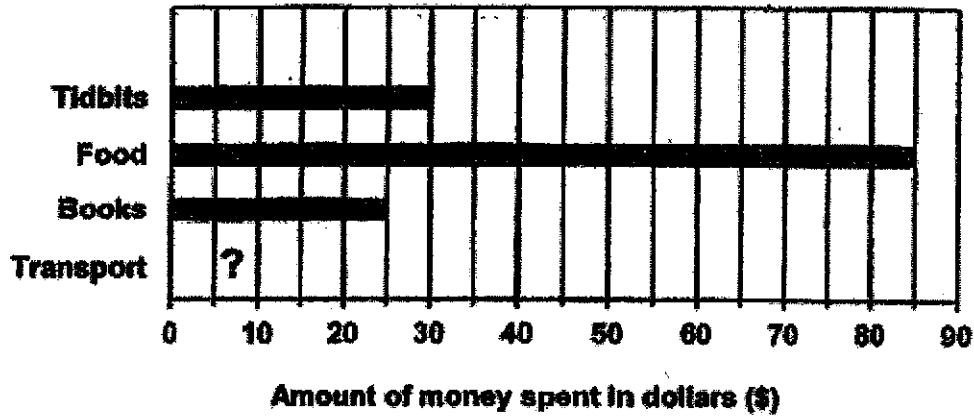

Sue spent a total \$200. How much did she spend on transport?

Ans: \$ _____

27. Arrange the following fractions from the smallest to the greatest



$$\frac{1}{2}, \frac{1}{8}, \frac{1}{5}, \frac{1}{3}$$

Ans: _____ , _____ , _____ , _____
(smallest) (greatest)

28. Mrs Chandra bought a total of 35 red and green apples. $\frac{2}{5}$ of them were green apples. How many green apples did she buy?

Ans: _____

29. Mrs Chen went to the supermarket and bought the items shown below. She paid the cashier \$20 and did not receive any change.

		
Milk \$2.80	Banana \$3.90	Shampoo ?

How much did the bottle of shampoo cost?

Ans: \$ _____

30. What is the size of $\angle AOB$?

Do not write
in this space

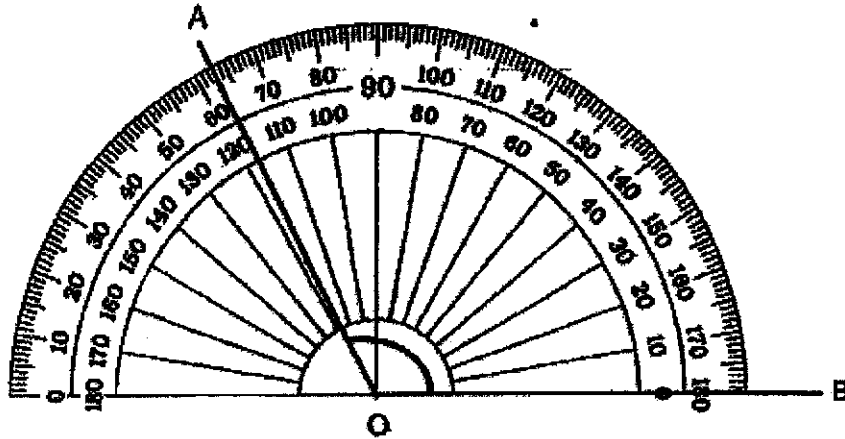

Ans: _____

31. Kenny had a rectangular piece of paper measuring 25 cm by 18 cm. He cut out as many squares as possible from the paper. The side of each square was 3 cm. How many squares did Kenny cut out?

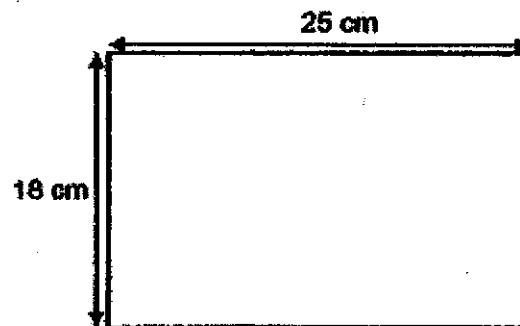

Ans: _____

32. Look at the grid below.
 ST is one side of the rectangle STUV with a perimeter of 20 cm.
 Complete the drawing of the rectangle and label the points U and V.

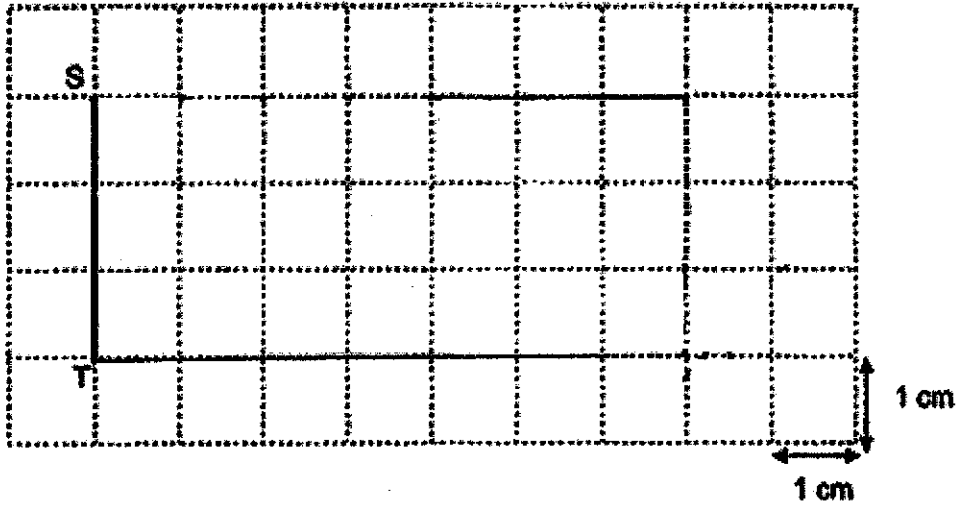

33. The table shows the number of children who like the different flavoured ice creams.

Vanilla	Raspberry	Strawberry	Chocolate
38	18	45	?

$\frac{1}{3}$ of the children like Vanilla, Raspberry and Strawberry flavoured ice creams.

How many children like Chocolate flavoured ice creams?

Ans: _____

34. The figure below is made up of 5 identical squares. The area of the figure is 500 cm^2 . Find the length of 1 square.

Do not write in this space

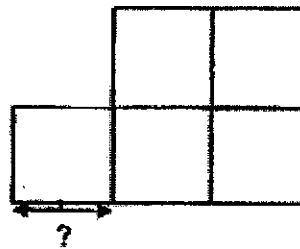

Ans: _____ cm

35. Shade only 2 more squares in the figure below, so that the dotted line AB is a line of symmetry.

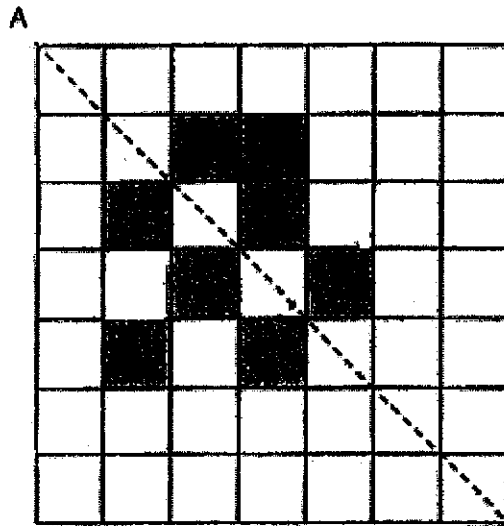

B

36. A rectangular piece of paper was folded to form the shape as shown below. Find the area of the rectangular piece of paper before it was folded.

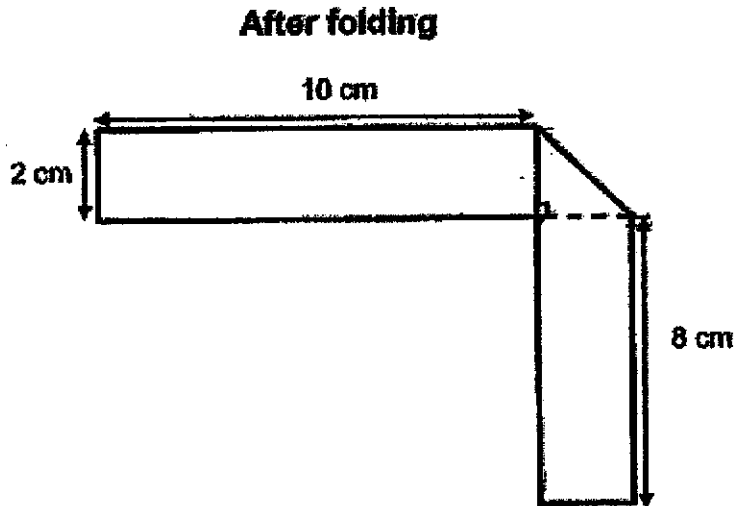

Do not write
in this space

Ans: _____ cm²

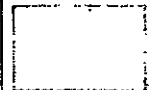

For questions 37 to 43, show your working clearly in the space provided for each question and write your answers in the spaces provided. The number of marks available is shown in brackets [] at the end of each question or part-question. (28 marks)

Do not
write in
this
space

37. Layla, Kris and Mary had 610 stickers altogether. Layla had 89 stickers fewer than Kris. Mary had 42 more stickers than Kris.

- (a) How many stickers did Layla have?
- (b) How many stickers did Mary have?

Ans: (a) _____ [3]

(b) _____ [1]

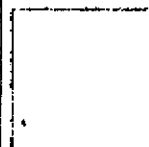

38. Objects A, B and C are placed on a weighing scale as shown below.

Object A has a mass of $1\frac{1}{5}$ kg. Object B has a mass of $\frac{9}{10}$ kg.

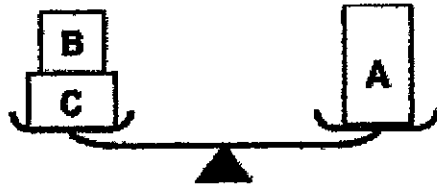

- (a) Find the mass of Object C.
- (b) i) Which object is heavier, Object B or Object C?
 ii) How much heavier?
 (Give your answers in the simplest forms.)

Ans: (a) _____ [2]

(b) i) Object _____ [1]

ii) _____ [1]

Do not
write in
this
space

39. Baker's Factory had a special offer as shown in the chart below.

Special Offer!!

1 donut for \$2.50

6 donuts for \$12



- (a) Mrs Koh needed to get 18 donuts.
What was the least amount of money she needed to pay?
- (b) Paul had \$42.50. What was the most number of donuts he could have bought?

Ans: (a) _____ [1]

(b) _____ [3]

Do not
write in
this
space

40. Mr Hafiz bought a total of 20 adults and children tickets to the Zoo for \$164. The prices of the tickets are shown below. How many children tickets did he buy?

Do not
write in
this
space

Tickets	
Per Adult	\$10
Per Child	\$7

Ans: _____ [4]

41. Oliver had an equal number of red and blue marbles. After giving away 75 red marbles, he had 4 times as many blue marbles as red marbles.

(a) How many red marbles did Oliver have in the end?

(b) How many blue marbles did Oliver have ?

Do not
write in
this
space

Ans: (a) _____ [2]

(b) _____ [2]

42. Some 10¢, 20¢ and 50¢ coins are used to form the patterns shown below.

Do not write in this space

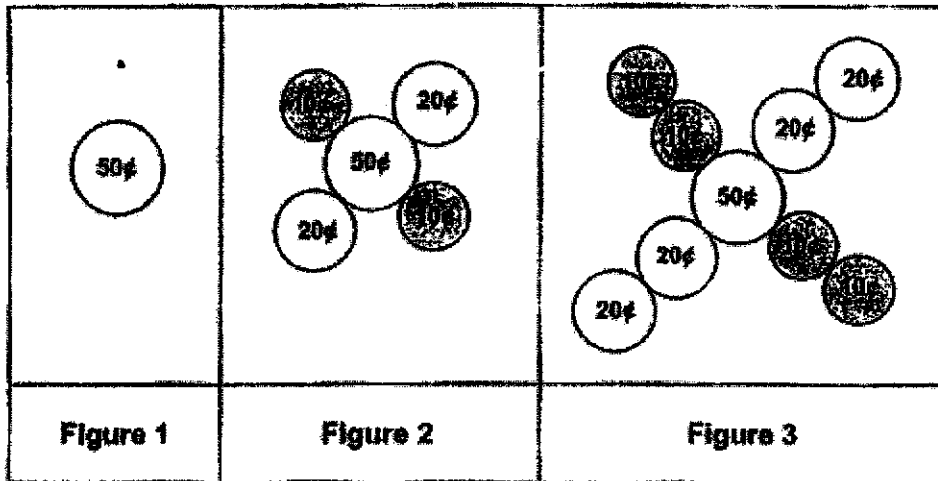

The table below shows the number of coins and the total value of coins used to form the pattern above.

Figure Number	Number of coins	Total value of coins
1	1	\$0.50
2	5	\$1.10
3	9	\$1.70
4	(a) _____	(a) _____

[1]

- (a) Complete the table for Figure 4.
- (b) Find the total value of the coins in Figure 7.
- (c) Which Figure Number will need 41 coins?

(You may continue your working on this page.)

Answer: (b) _____ [1]

(c) _____ [2]



43. The figure below is made up of two identical rectangular mats overlapping each other. Each mat measures 8 m by 5 m. The area of the overlap is 10 m^2

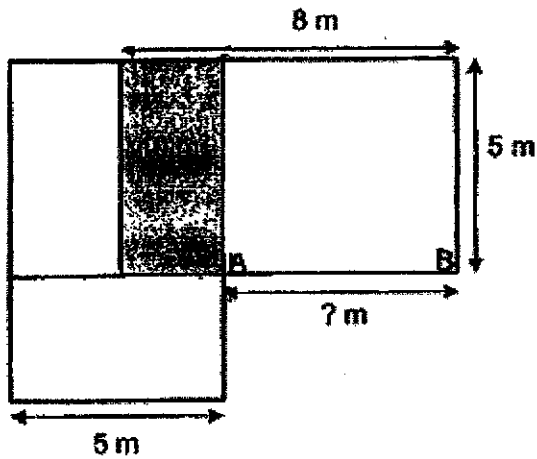

- (a) Find the length AB.
 (b) Find the perimeter of the figure shown above.

Ans: (a) _____ [2]

(b) _____ [2]

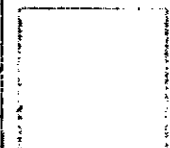

End of Paper

Do not
write in
this
space

SCHOOL : PAYA LEBAR METHODIST GIRLS' SCHOOL
 LEVEL : PRIMARY 4
 SUBJECT : MATH
 TERM : 2020 SA2

BOOKLET A

Q1	Q2	Q3	Q4	Q5	Q6	Q7	Q8	Q9	Q10
2	4	1	3	1	2	3	4	4	4

Q11	Q12	Q13	Q14	Q15	Q16
1	2	3	2	3	1

BOOKLET B

Q17)	9008
Q18)	9
Q19)	0.004
Q20)	5950
Q21)	$\frac{5}{8}$
Q22)	11
Q23)	5
Q24)	9.08
Q25)	f
Q26)	60
Q27)	$\frac{1}{8}, \frac{1}{5}, \frac{1}{3}, \frac{1}{2}$
Q28)	14 green apples

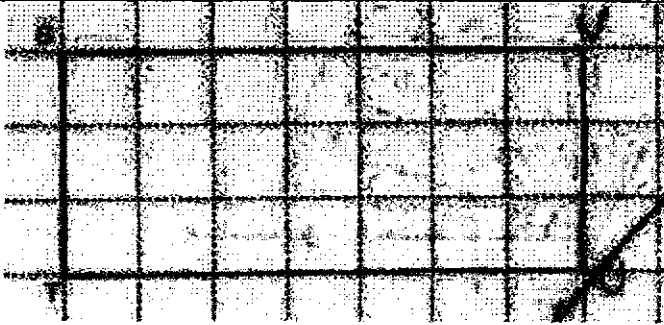
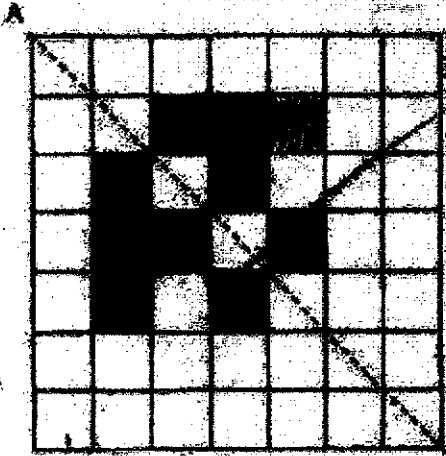
Q29)	\$13.30
Q30)	117°
Q31)	48
Q32)	
Q33)	202
Q34)	10cm
Q35)	
Q36)	$10 + 2 + 8 = 20$ $20 \times 2 = 40$ <p>ans: 20cm²</p>
Q37)	$89 + 89 + 42 = 22$ $610 - 220 = 390$ <p>(a) $390 \div 3 = 130$</p> <p>(b) $130 + 89 + 42 = 261$</p>

Q38)	<p>(a) $1\frac{2}{10} - \frac{9}{10} = \frac{3}{10}$</p> <p>(b) $\frac{9}{10} - \frac{3}{10} \Rightarrow \frac{3}{5}$</p>
Q39)	<p>(a) \$36</p> <p>(b) $42.50 - 36 = 6.50$</p> <p style="text-align: center;">$6.50 \div 2.50 = 2R1.50$</p> <p style="text-align: center;">$18 + 2 = 20$</p> <p style="text-align: center;"><i>ans: 20</i></p>
Q40)	<p style="text-align: center;"><i>assume all adult tickets,</i></p> <p style="text-align: center;">$10 \times 20 = 200$</p> <p style="text-align: center;">$200 - 164 = 36$</p> <p style="text-align: center;">$10 - 7 = 3$</p> <p style="text-align: center;">$36 \div 3 = 12$</p>
Q41)	<p>(a) $75 \div 3 = 25$</p> <p>(b) $75 + 25 = 100$</p>
Q42)	<p>(a) 13, \$2.30</p> <p>(b) <i>fig 7 = 60cents</i> $\times 7 = 4.20 - 10cents = \\4.10</p> <p>(c) 11</p>
Q43)	<p>(a) 6m</p> <p>(b) $8 + 5 + 3 + 6 + 5 + 8 + 3 = 38m$</p>

