



HENRY PARK PRIMARY SCHOOL
2020 SEMESTRAL EXAMINATION
MATHEMATICS
PRIMARY 4

Name: _____ ()

Parent's Signature

Class: Primary 4 _____

Duration of Paper: 1 h 45 min

Marks:

Section A (MCQ)	20
Section B (Open-Ended)	50
Section C (Problem Sums)	30
Total	100

Section A: Multiple Choice Questions (10 x 2 marks = 20 marks)

Read each question carefully. For each question, 4 options are given. One of them is the correct answer. Make your choice (1, 2, 3 or 4). Shade the correct ovals on the Optical Answer Sheet.

1. The value of the digit 4 in 74 325 is _____.

- (1) 40
- (2) 400
- (3) 4000
- (4) 40 000

()

2. 34 856 rounded to the nearest hundred is _____.

- (1) 35 000
- (2) 34 900
- (3) 34 860
- (4) 34 800

()

3. Which of the following is not an equivalent fraction of $\frac{1}{4}$?

- (1) $\frac{2}{8}$
- (2) $\frac{3}{12}$
- (3) $\frac{4}{12}$
- (4) $\frac{4}{16}$

()

4. In the figure below, what is the length of the mechanical pencil in cm?

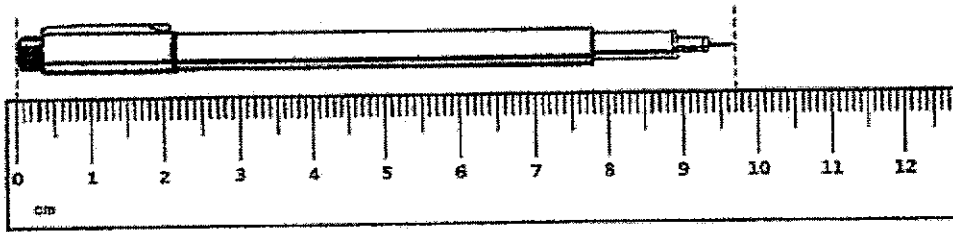

- (1) 9.2 cm
 (2) 9.7 cm
 (3) 10.3 cm
 (4) 10.7 cm

()

5. Write $3\frac{7}{20}$ as a decimal.

- (1) 3.72
 (2) 3.7
 (3) 3.35
 (4) 3.035

()

6. In the figure, which two lines below are perpendicular?

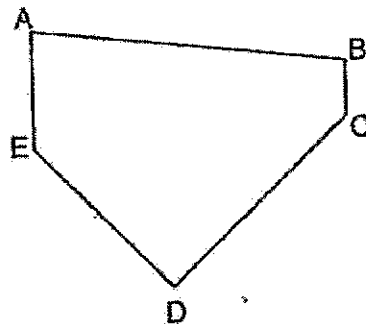

- (1) AB and BC
 (2) AE and AB
 (3) AE and BC
 (4) CD and DE

()

7. The figure below is made up of three rectangles. Find the perimeter of the figure.

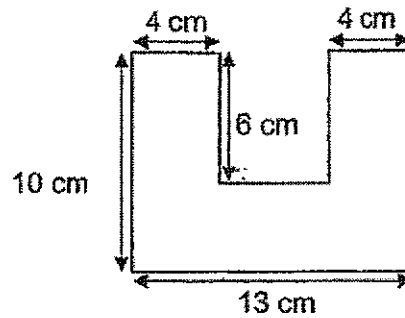

- (1) 42 cm
 (2) 46 cm
 (3) 50 cm
 (4) 58 cm

()

8. The line graph below shows the number of cakes sold in a bakery from Monday to Thursday.

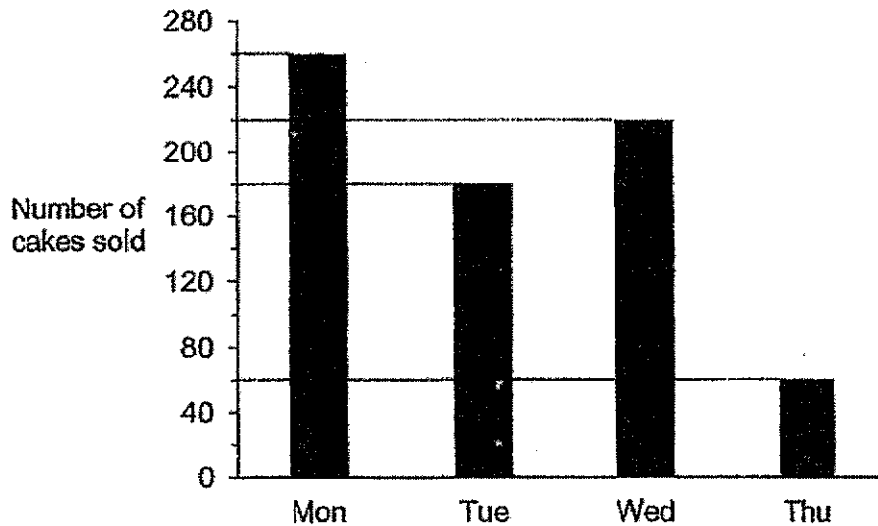

How many more cakes were sold on Tuesday than on Thursday?

- (1) 80
 (2) 100
 (3) 120
 (4) 160

()

9. There were 45 people in a meeting room. $\frac{2}{5}$ of the people were men. How many women were there in the room?

- (1) 9
 (2) 18
 (3) 27
 (4) 43

()

10. Four figures, A, B, C and D, are shown below.
 Which of the figure(s), A, B, C and/or D is/are symmetrical?

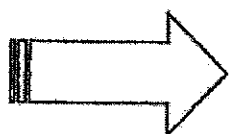

Figure A



Figure B



Figure C



Figure D

- (1) A only
 (2) A and C only
 (3) A, B and D only
 (4) None of the above

()

(Go on to Section B)

Section B: Open-Ended Questions (25 x 2 marks = 50 marks)

Read the questions carefully and write the correct answer in the blanks provided. Show your workings clearly.

11. Arrange the following numbers from the smallest to the greatest.

6904 , 6049 , 6490

Ans: _____ , _____ , _____
(smallest) (greatest)

12. $3754 + 1587 =$ _____

Ans: _____

13. What number is 10 more than 9998?

Ans: _____



14. Write $4\frac{3}{4}$ as an improper fraction.

Ans: _____

15. What is the value of $\frac{7}{8} + \frac{1}{4}$?

Express your answer as a mixed number.

Ans: _____

16. Find the value of $1 - \frac{2}{3} - \frac{1}{9}$

Ans: _____

17. Find the value of 6.52×8

Ans: _____



18. Write the decimal represented by A.

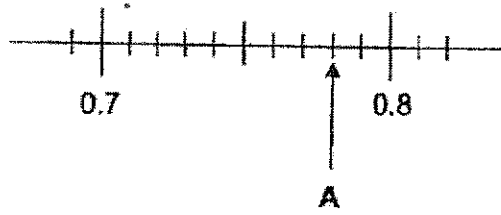

Ans: _____

19. In the figure, ABCD is a rectangle. Find the value of $\angle x$.

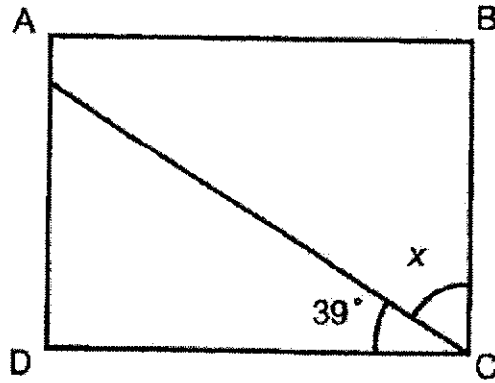

Ans: _____ °



20. Jacky drew a triangle, ABC, as shown below.

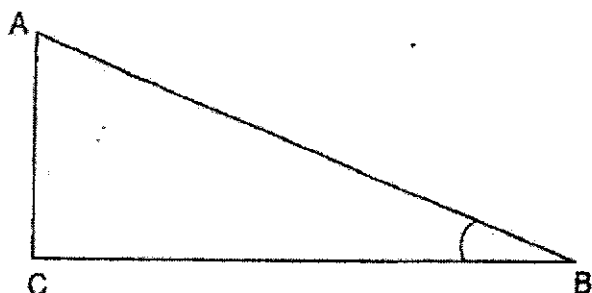

- a) Measure and write down the size of $\angle ABC$ in the figure.

Ans: (a) _____^o

- b) Measure the length of AC. Round your answer to 1 decimal place.

Ans: (b) _____ cm

21. The graph below shows the number of stickers collected by 5 children.

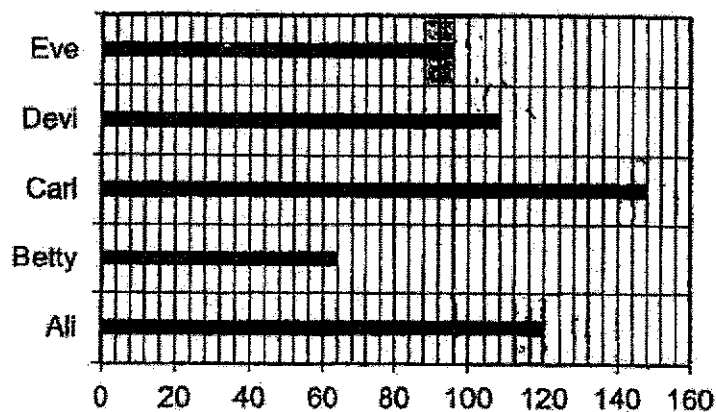

How many stickers did Ali, Carl and Eve collect altogether?

Ans: _____



22. Mr Tan had some oranges to be packed into 43 boxes. He packed 7 oranges into each box except for the last box. Given that Mr Tan packed only 2 oranges into the last box, how many oranges did Mr Tan have altogether?

Ans: _____

23. A box with 6 mangoes has a total mass of 7.44 kg. The mass of the box is 1.2 kg when empty. What is the mass of each mango in kilograms?

Ans: _____ kg



24. Lina started school at 7.25 a.m. She had lessons till 1.15 p.m. After her lessons, she spent 2 h 45 min in the school library reading. After that, she left for home.
- How long did Lina spend having lessons in school? Express your answer in minutes.
 - What time did Lina leave school for home?

Ans: (a) _____ min

(b) _____ p.m.

25. Ryan had a piece of wire 35 cm long. He bent the wire to form a rectangle of breadth 6 cm. He then had 5 cm of wire left. What was the length of the rectangle Ryan formed?

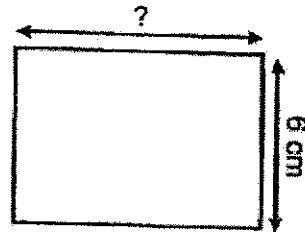

Ans: _____ cm



26. a) Complete the figure below so that the dotted line XY is the line of symmetry.

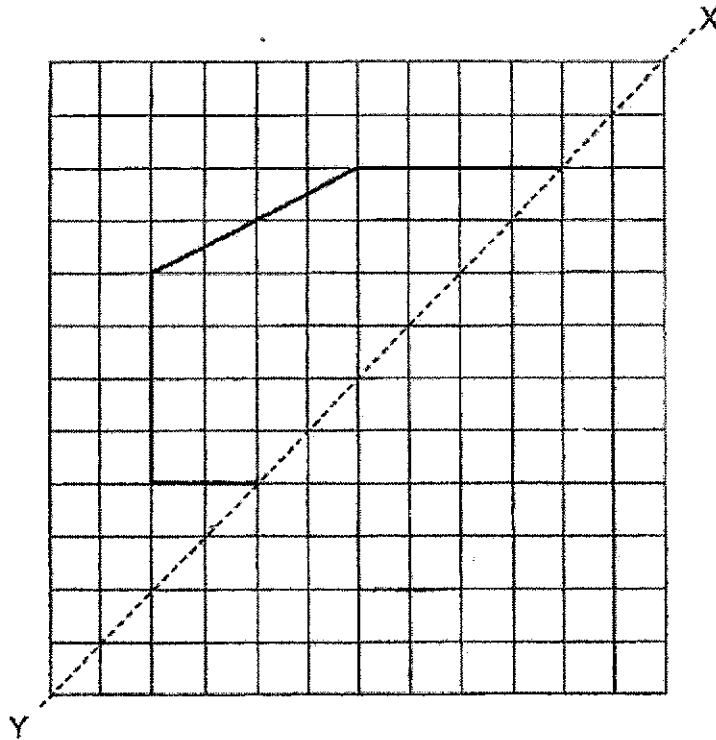

- b) Shade one more square so that the figure below becomes symmetrical.

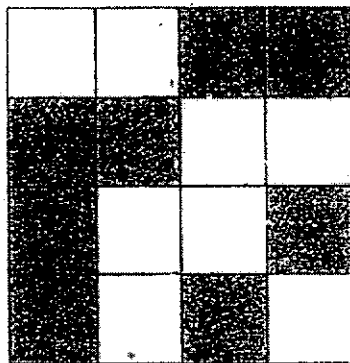

27. Kate is now standing at Point X and facing the school.

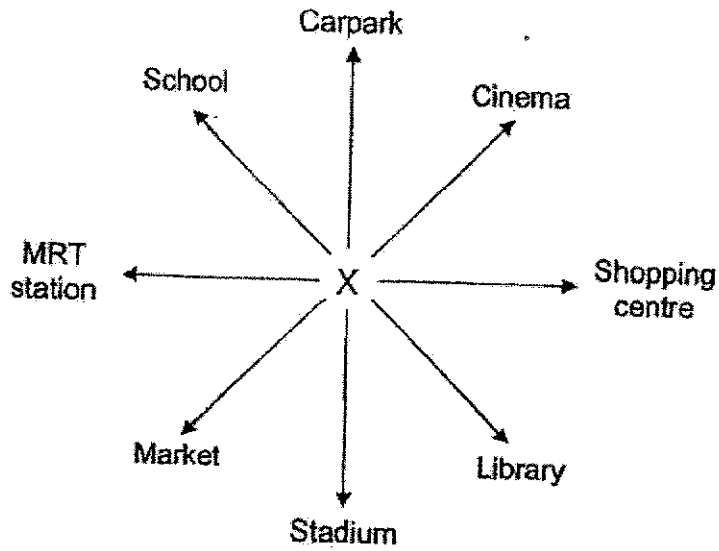

a) Which building will she face after making a $\frac{3}{4}$ -turn in the anti-clockwise direction?

Ans: (a) _____

b) The MRT station is to the north of Point X. Which building is to the south-west of Point X?

Ans: (b) _____



28. Nila travelled from Johor Bahru to Singapore by bus. The bus journey took 135 minutes.
- Express 135 minutes in hours and minutes.
 - Given that Nila reached Singapore at 9 a.m., what time did the bus leave Johor Bahru?

Ans: (a) _____ h _____ min

(b) _____ a.m.

29. Teams A, B, C and D took turns to play a match against one another. Each team played only once with another team. How many matches did the 4 teams play altogether?

Ans: _____



30. The table below shows the number of pupils who chose to attend Math enrichment lessons from Monday to Friday. Each pupil could only choose one day.

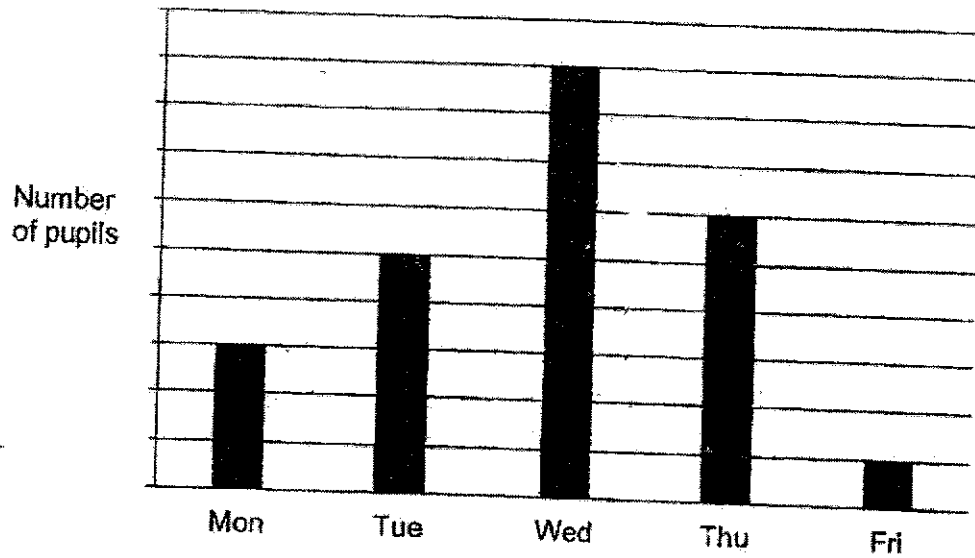

Given that 48 pupils chose to attend Math enrichment lessons on Thursday, find the total number of pupils who chose to attend Math enrichment lessons from Monday to Friday.

Ans: _____



31. George and Jane shared a sum of \$152. George received $\frac{1}{8}$ of the sum of money. How much money must Jane give to George so that they will have the same amount of money?

Ans: \$ _____

32. Apples are sold at the prices shown below.

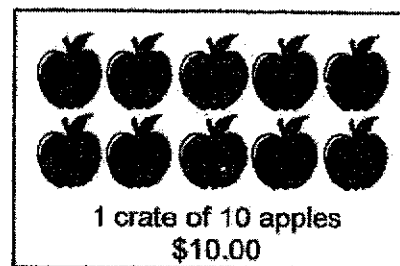
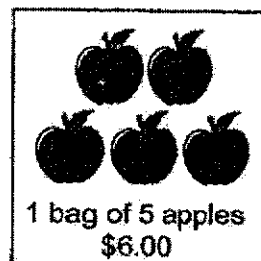

Ali wants to buy 17 apples for a class party. What is the least amount of money he needs to pay for the apples?

Ans: \$ _____

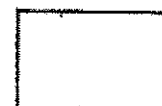

33. Jenny paid a total of \$8.50 for 2 pens and 1 pencil. A pen cost \$1.25 more than a pencil. How much did Jenny pay for one pen?

Ans: \$ _____

34. Maria has some striped and dotted balls. Balls of the same pattern have the same mass. The scales below show the mass of the balls. What is the mass of one dotted ball?

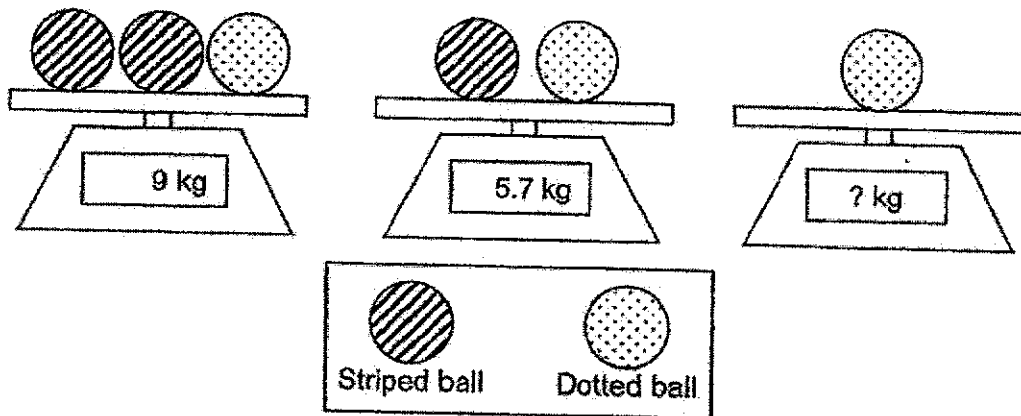

Ans: _____ kg



35. Figure Q is drawn by joining some dots on the square grid below with straight lines.

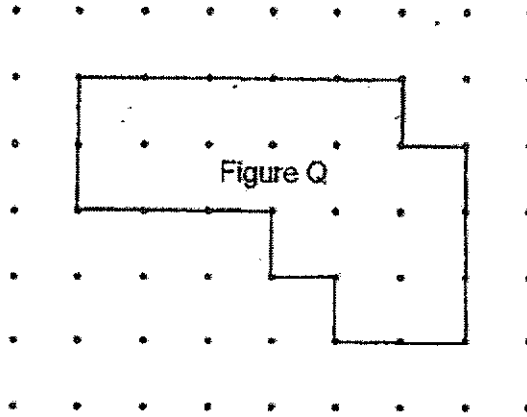

In the same way,

- a) draw a rectangle with the same perimeter as Figure Q on the square grid below.

- b) draw a square with the same area as Figure Q on the square grid below.

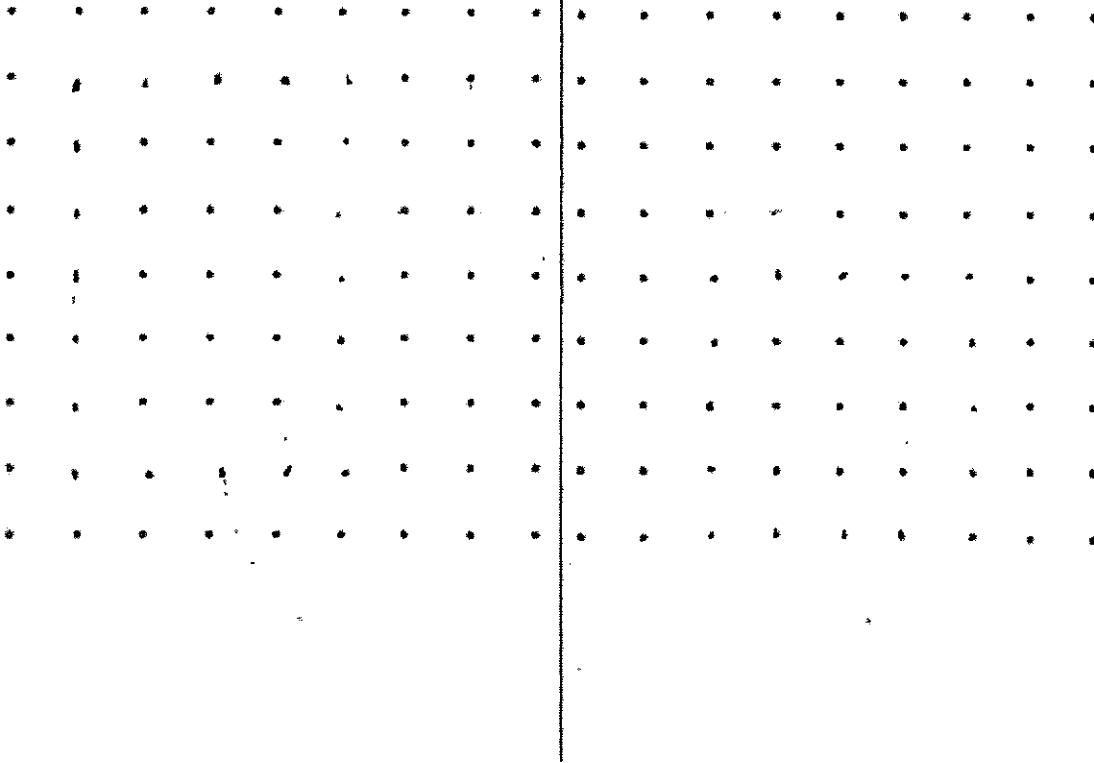

NAME: _____ CLASS: Primary 4 _____

Section C: Problem Sums (30 marks)

Read the following problem sums carefully. You may draw models to help you. Show all working clearly and write your answers in the spaces provided. The number of marks allocated is shown in brackets [] at the end of each question.

36. Suri mixed 17.47 l of red paint and 15.29 l of yellow paint in a big pail to get orange paint. She then poured the orange paint equally into 7 identical small tins. How many litres of orange paint were there in each small tin?

Ans: _____ [3]



37. A painting measures 35 cm by 23 cm. It is placed on a board that is 40 cm by 29 cm. What is the area of the board that is not covered by the painting?

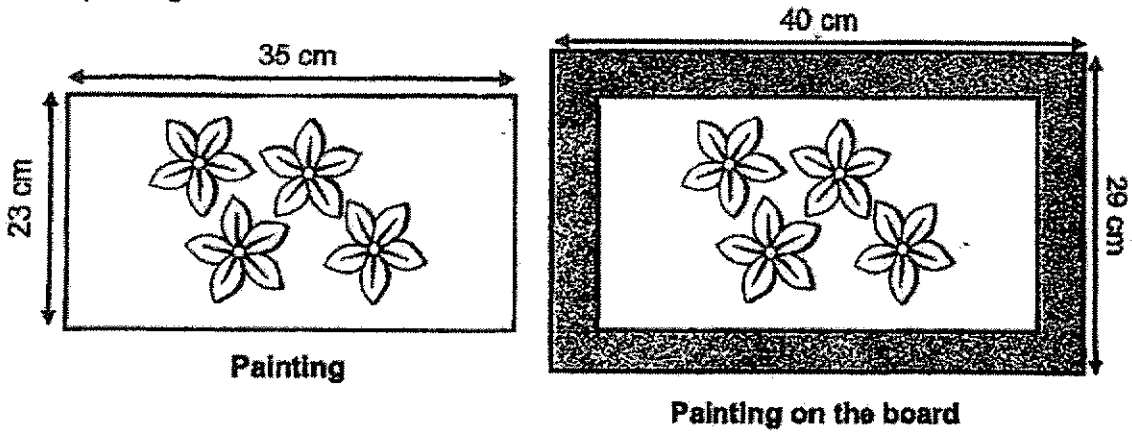

Ans: _____ [4]

38. A stall holder uses 2.78 kg of rice each day.
- a) What is the total mass of rice the stall holder uses in a week?
 - b) Rice is sold in 1-kg bags at \$2 each bag. What is the least amount of money the stall holder will need to pay for the rice for the week?

Ans: (a) _____ [2]

(b) _____ [2]

39. Philip had some identical square tiles of side 9 cm. He placed all the tiles side by side without any gaps in between each tile to form a rectangle of perimeter 792 cm as shown below. How many square tiles did Philip have?



Ans: _____ [4]



40. At first, Mei Mei had thrice as many tokens as Emma. After Mei Mei used 685 tokens in the morning and 979 tokens in the afternoon, Emma had thrice as many tokens as Mei Mei. How many tokens did Emma have?

Ans: _____ [4]



41. Bala and Ethan had a total of 800 marbles. Bala gave 105 marbles to Ethan. Ethan then gave 49 marbles to Bala. In the end, Bala has four times as many marbles as Ethan. How many marbles did Ethan have at first?

Ans: _____ [4]

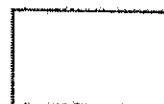

42. Mrs Ling had 248 chicken pies and potato puffs for sale. After selling 150 chicken pies and $\frac{1}{4}$ of the potato puffs, she had an equal number of chicken pies and potato puffs left. What is the total number of chicken pies and potato puffs Mrs Ling had left?

Ans: _____ [3]



43. Mandy placed all the boxes of cookies she had on 35 shelves. She placed the same number of boxes of cookies on each shelf. 5 of the shelves broke and the boxes of cookies on these shelves were placed on the remaining 30 shelves. In the end, the number of boxes of cookies on each remaining shelf increased by 3. How many boxes of cookies did Mandy have in total?

Ans: _____ [4]

-END OF PAPER-



ANSWER KEY

YEAR: 2020

LEVEL: PRIMARY 4

SCHOOL: HENRY PARK PRIMARY SCHOOL

SUBJECT: MATHEMATICS

TERM: SEMESTRAL EXAMINATION

Q1	3	Q2	2	Q3	3	Q4	2	Q5	3
Q6	4	Q7	4	Q8	3	Q9	3	Q10	1

Q11	6049, 6490, 6904
Q12	5341
Q13	10008
Q14	$4 \times 4 = 16$ $16 + 3 = 19$ $\frac{19}{4}$
Q15	$\frac{1}{4} = \frac{2}{8}$ $\frac{7}{8} \times \frac{1}{4} = 1\frac{1}{8}$
Q16	$\frac{2}{3} \rightarrow \frac{6}{9}$ $\frac{6}{9} + \frac{1}{9} = \frac{7}{9}$ $1 - \frac{7}{9} = \frac{2}{9}$
Q17	6.52×8 $= 52.16$
Q18	0.78
Q19	$90 - 39 = 51^\circ$
Q20	(a) 22° (b) 3.3cm
Q21	$120 + 96 + 148 = 364$
Q22	$43 - 1 = 42$ $42 \times 7 = 294$ $294 + 2 = 296$ $294 + 2 = 296$
Q23	$1.2 = 1.20$ $7.44 - 1.20 = 6.24$ $6.24 \div 6 = 1.04\text{kg}$

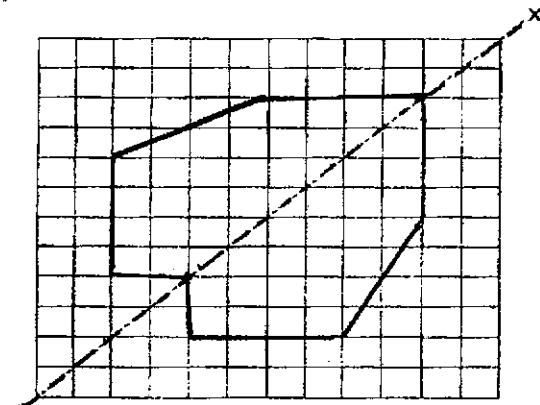
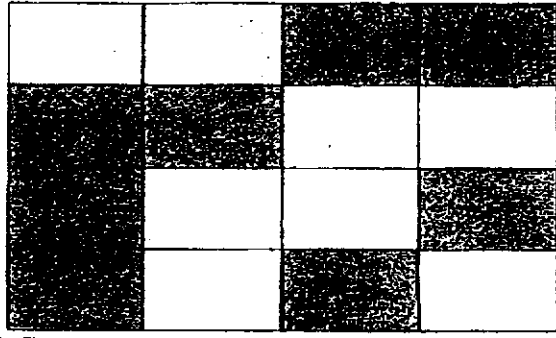
Q24	(a)350min (b)4p.m.
Q25	$35-5=30$ $30-6-6=18$ $18\div 2=9\text{cm}$
Q26	(a) 
	(b) 
Q27	(a)Cinema (b)Library
Q28	(a)2h 15min (b)6.45 a.m.
Q29	6 matches
Q30	192
Q31	$152\div 8=19$ $19\times 3=\$57$
Q32	\$19
Q33	$8.50+1.25=9.75$ $9.75\div 3=\$3.25$
Q34	$9-5.7=3.3$ $5.7-3.3=2.4\text{kg}$

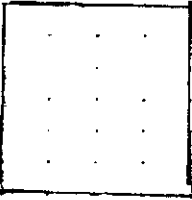
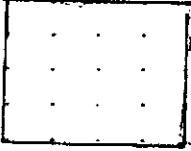
Q35	<p>(a)</p>  <p>(b)</p> 
Q36	$17.474 + 15.29 = 32.76$ $32.76 \div 7 = 4.68L$
Q37	$23 \times 35 = 805$ $1160 - 805 = 355cm$
Q38	$2.78 \times 7 = 19.46$ $19.46 \rightarrow 20kg$ $20kg \times 2 = 40$ (a) 19.46kg (b) \$40
Q39	$792 - 9 - 9 = 774$ $774 \div 2 = 387$ $387 \div 9 = 43$
Q40	$979 + 685 = 1664$ $1664 \div 8 = 208$ $208 \times 3 = 624$
Q41	$800 \div 5 = 160$ $160 + 49 = 209$ $209 - 105 = 104$
Q42	$248 + 50 = 98$ $98 \div 7 = 14$ $14 \times 6 = 84$
Q43	$35 - 5 = 30$ $30 \times 3 = 90$ $90 \div 5 = 18$ $18 \times 35 = 630$

