



RED SWASTIKA SCHOOL

2019 SEMESTRAL ASSESSMENT 2

MATHEMATICS

Name : _____ ()

Class : Primary 4 / _____

Date : 25 Oct 2019

BOOKLET A

20 Questions

40 Marks

Duration of Paper : 1 hour 45 minutes

Note:

1. Do not open this Booklet until you are told to do so.
2. Read carefully the instructions given at the beginning of each part of the Booklet.
3. Do not waste time. If a question is difficult for you, go on to the next one.
4. Check your answers thoroughly and make sure you attempt every question.
5. In this booklet, you should have the following:
 - (a) Page 1 to Page 5
 - (b) Questions 1 to 20

Questions 1 to 20 carry 2 marks each. For each question, four options are given. One of them is the correct answer. Make your choice (1, 2, 3 or 4). Shade the correct oval (1, 2, 3 or 4) on the Optical Answer Sheet.

(40 marks)

1 In which of the following numbers does the digit 9 stand for 900?

- (1) 7809
- (2) 7980
- (3) 8790
- (4) 9780

2 Seventy-four thousand and fifty-two in figures is _____.

- (1) 74 520
- (2) 74 502
- (3) 74 052
- (4) 7452

3 How many one-sevenths are there in 2 wholes?

- (1) $3\frac{1}{2}$
- (2) $\frac{2}{7}$
- (3) 7
- (4) 14

4 Find the value of $\frac{5}{8} - \frac{1}{4}$.

- (1) $\frac{1}{2}$
- (2) $\frac{1}{8}$
- (3) $\frac{3}{4}$
- (4) $\frac{3}{8}$

- 5 In the figure below, which angle is greater than a right angle?

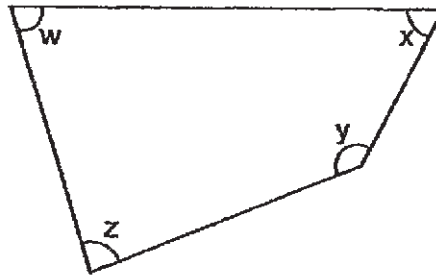

- (1) $\angle w$
(2) $\angle x$
(3) $\angle y$
(4) $\angle z$
- 6 The digit 3 in 4.132 stands for 3 _____.
- (1) ones
(2) tens
(3) tenths
(4) hundredths
- 7 Which of the following is a multiple of both 5 and 6?
- (1) 11
(2) 20
(3) 36
(4) 60
- 8 Alice began her enrichment lesson at 15 45. She finished the lesson at 17 10. How long was her lesson?
- (1) 55 min
(2) 75 min
(3) 85 min
(4) 165 min
- 9 A number when rounded to the nearest hundred is 60 000. What is the greatest possible value of that number?
- (1) 59 499
(2) 59 999
(3) 60 049
(4) 60 099

The table below shows the number of students who borrowed books from the school library.

Number of books borrowed	1	2	3	4	5
Number of students	50	125	275	155	30

10 How many students borrowed more than 3 books?

- (1) 185
- (2) 275
- (3) 430
- (4) 460

11 The figure below is made up of a rectangle ABCD and a square CEFG. Find the length of DE.

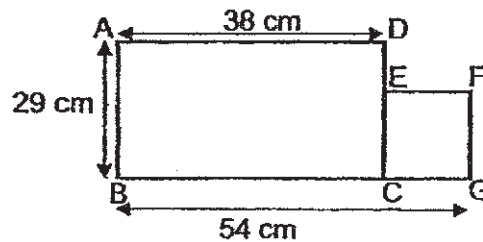

- (1) 9 cm
- (2) 13 cm
- (3) 16 cm
- (4) 22 cm

12 A rectangular piece of cardboard has a perimeter of 82 cm. What is the breadth of the piece of cardboard if its length is 22.5 cm?

- (1) 18.5 cm
- (2) 29.75 cm
- (3) 37 cm
- (4) 59.5 cm

13 What is the area of Square WXYZ given that its perimeter is 56 cm?

- (1) 14 cm²
- (2) 28 cm²
- (3) 112 cm²
- (4) 196 cm²

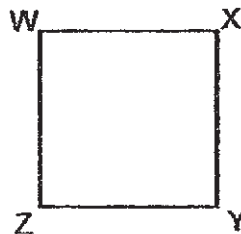

14 Which of the following has the same value as 65.07?

- (1) $\frac{6507}{100}$
- (2) $\frac{6507}{1000}$
- (3) 6 + 5 + 7 tenths
- (4) 65 + 0.7

15 What is the value when 40.17 is multiplied by 7? Round off your answer to the nearest tenth.

- (1) 280.2
- (2) 280.8
- (3) 281.1
- (4) 281.2

16 A New Year party started at 20 30 on Friday. The party lasted for 2 h 35 min. What time did the party end?

- (1) 17 55
- (2) 18 35
- (3) 22 05
- (4) 23 05

17 Which of the following figures has no line of symmetry?

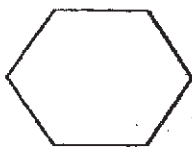

A

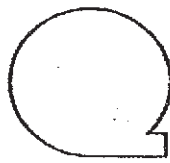

B

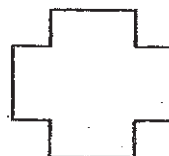

C

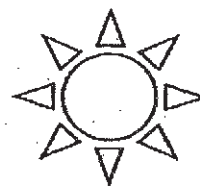

D

- (1) A
- (2) B
- (3) C
- (4) D

Use the following diagram to answer Questions 18 and 19.

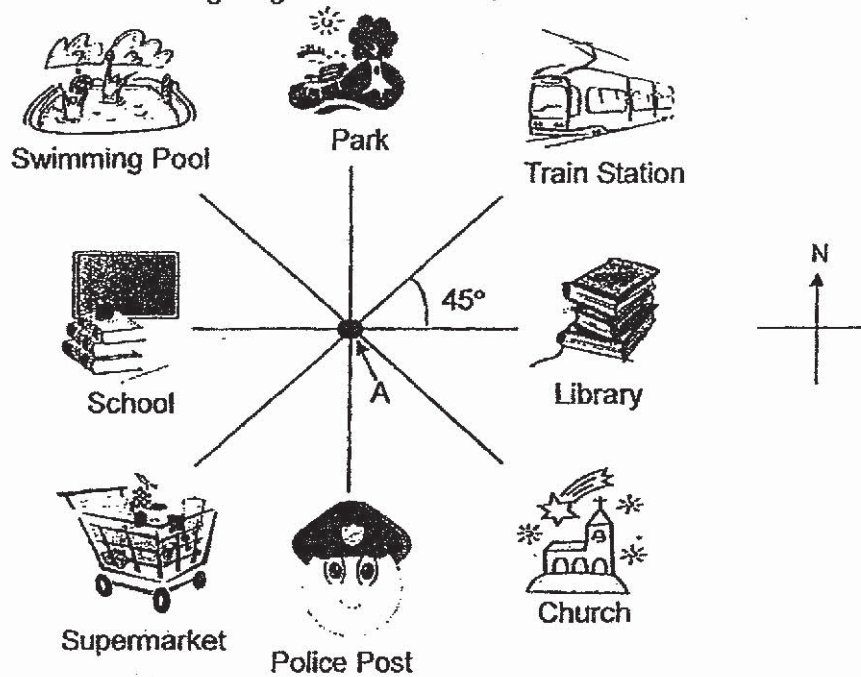

- 18 If Bryan is at Point A facing East and he turns 225° clockwise, where will he be facing?
- (1) Church
 - (2) Train Station
 - (3) Supermarket
 - (4) Swimming Pool
- 19 Bryan is still at Point A but he is facing the police post now. He makes a 135° clockwise turn. Then he makes a _____ in the anticlockwise direction to face the train station.
- (1) $\frac{1}{4}$ -turn
 - (2) $\frac{1}{2}$ -turn
 - (3) $\frac{3}{4}$ -turn
 - (4) 1 complete turn

20 Andrew had 25 more stickers than Brandon. Charles had 3 times as many stickers as Andrew. If the three of them had 245 stickers altogether, how many more stickers had Charles than Andrew?

- (1) 29
 - (2) 54
 - (3) 108
 - (4) 162
-



RED SWASTIKA SCHOOL

2019 SEMESTRAL ASSESSMENT 2

MATHEMATICS

Name : _____ ()

Class : Primary 4 / _____

Date : 25 Oct 2019

BOOKLET B

28 Questions
60 Marks

In this booklet, you should have the following:

- (a) Page 7 to Page 17
- (b) Questions 21 to 48

MARKS

	OBTAINED	POSSIBLE
BOOKLET A		40
BOOKLET B		60
TOTAL		100

Parent's Signature : _____

Questions 21 to 30 carry 1 mark each. Questions 31 to 40 carry 2 marks each. Show your working clearly in the space below each question and write your answers in the spaces provided. For questions which require units, give your answers in the units stated.

(30 marks)

21 What is the length of a square with an area of 81 cm^2 ?

Ans: _____ cm

22 What is the perimeter of the figure below?

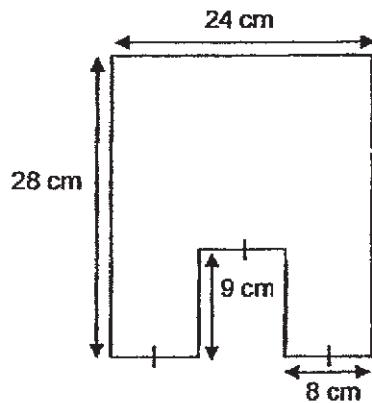

Ans: _____ cm

23 What is the missing number in the box?

$$\begin{array}{r}
 76R1 \\
 \hline
 \boxed{?} \overline{) 457} \\
 \underline{42} \\
 37 \\
 \underline{36} \\
 1
 \end{array}$$

Ans: _____

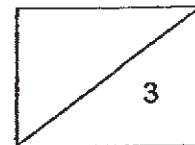

The line graph below shows the amount of money Mr Toh earned from selling fruits from April to September. Study the graph carefully and use it to answer Questions 24 to 27.

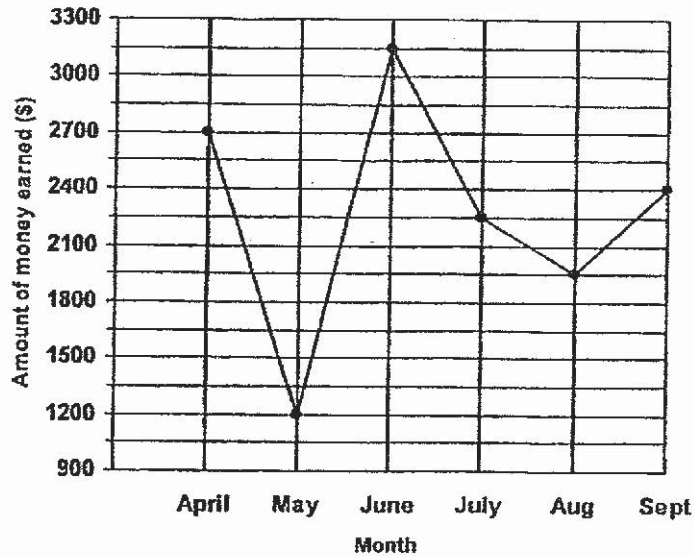

24 What was Mr Toh's earnings from April to July?

Ans: \$ _____

25 What was the difference in Mr Toh's earnings for June and August?

Ans: \$ _____

26 Mr Toh earned twice as much in one particular month than in another month. Which were the two months?

Ans: _____ and _____

27 If Mr Toh earned \$6 700 from August to October, how much did he earn in the month of October?

Ans: \$ _____

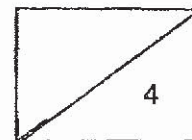

- 28 Look at the diagram below. Carol walked 1 step to the west, 2 steps to the south and 2 steps to the east. Who did she meet in the end?

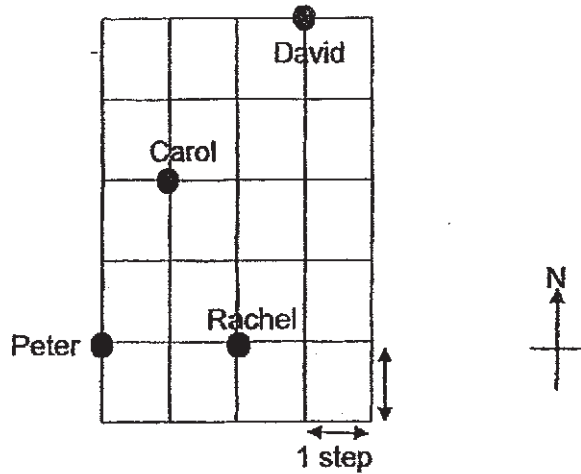

Ans: _____

- 29 Mr Tan drove from Singapore to Kuala Lumpur. After driving for 1 hour and 25 minutes, he stopped at Johor Bahru for lunch. He then continued driving for another 2 hours and 45 minutes to reach Kuala Lumpur. If he left Singapore at 0830 and reached Kuala Lumpur at 1305, how long did he take to have his lunch?

Ans: _____ min

- 30 The figure below is made up of a square and a rectangle. If the shaded area is 72 m^2 , what is the length of the rectangle if its breadth is 9 m ?

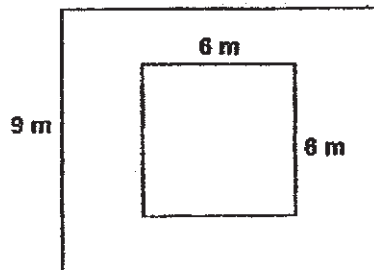

Ans: _____ m

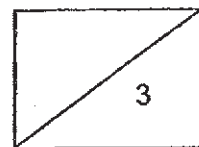

31 Write the missing number in the number pattern below.

13 000, 12 200, 11 400, 10 600, _____, 9000

Ans: _____

32 Find the product of 1390 and 8.

Ans: _____

33 Some factors of 18 are 1, 2, 3 and 18. What are the other two factors of 18?

Ans: _____ and _____

34 In the figure below, rectangle ABCD is made up of 8 unit squares. What fraction of rectangle ABCD is shaded?

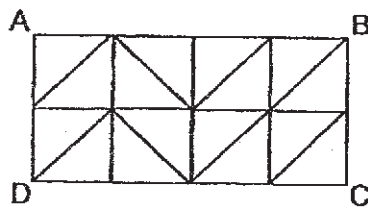

Ans: _____

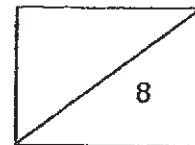

35 What is the value of $\frac{7}{9} + \frac{2}{3}$? Express your answer as a mixed number.

Ans: _____

36 In the figure, ABCD is a rectangle. Find the value of $\angle x$.

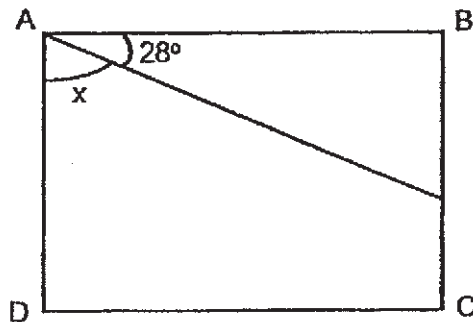

Ans: _____°

37 Write 5 thousandths as a decimal.

Ans: _____

38 Arrange the following numbers from the smallest to the greatest.

$\frac{3}{5}$, 0.706, 0.076

Ans: _____, _____, _____
(smallest) (greatest)

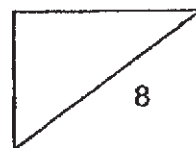

39 $8.5 - 0.76 =$ _____

Ans: _____

- 40 Shade three more squares to complete the figure which has AB as a line of symmetry.

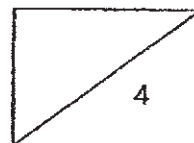
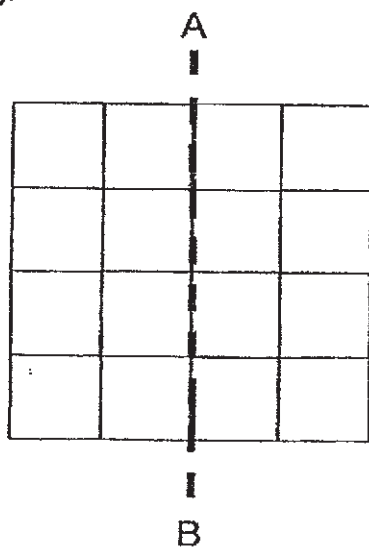

Questions 41 to 48 carry 3 or 4 marks each. Show your working clearly in the space below each question and write your answers in the spaces provided.
(30 marks)

- 41 The line graph below shows the number of teddy bears sold in a shop from July to December.

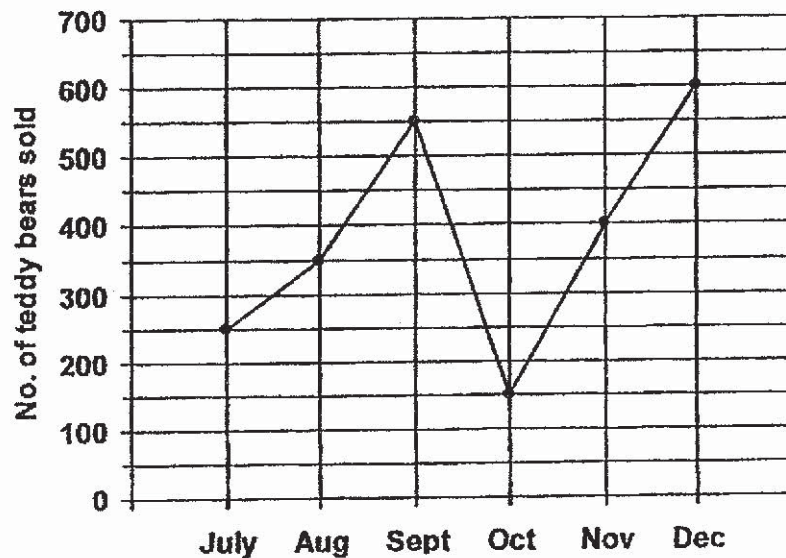

- (a) How many more teddy bears were sold in December than in October?
- (b) Given that the price of each teddy bear is \$6, what would be the total amount collected in the months from July to September?

Ans: (a) _____ [2]

(b) _____ [2]

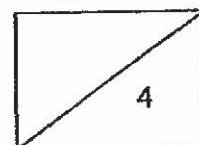

- 42 Muthu wants to buy 9 dinosaurs which are selling at the same price. However, he needs another \$12.40 in order to buy them. He then decides to buy 5 dinosaurs instead and has \$23.20 left. What is the cost of each dinosaur?

Ans: _____ [4]

- 43 The mass of a box containing 8 bottles of honey was 41.65 kg. When 2 bottles of honey were removed from the box, the mass became 32.15 kg. Find the mass of the empty box in kilograms. (Round off your answer to 1 decimal place.)

Ans: _____ [4]

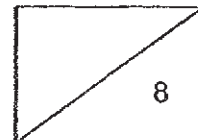

- 44 After buying a present with $\frac{3}{7}$ of her money, Amy had \$260 left.
How much money did she have at first?

Ans: _____ [3]

- 45 Mrs Soh's monthly salary is \$5589. She gives $\frac{1}{9}$ of it to her mother and spends $\frac{2}{3}$ of it on daily expenses. If she saves the rest of her salary, how much does she save in a month?

Ans: _____ [4]

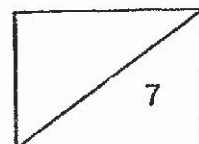

- 46 The total number of people in an auditorium was 6074. There were thrice as many women as men. There were 1289 more children than men. How many women were there in the auditorium?

Ans: _____ [4]

- 47 Ali had 4 times as many marbles as Jun Hao. After Ali gave 54 marbles to Jun Hao, they had the same number of marbles. How many marbles did each of them have now?

Ans: _____ [4]

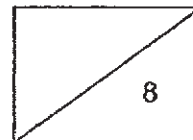

- 48 Lisa formed a figure with 3 small squares and 1 big square. If the perimeter of the shaded part of the figure is 16 cm, find the area of the big square.

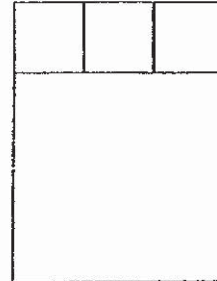

Ans: _____ [3]

End of Paper

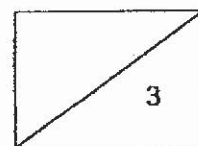

SCHOOL : RED SWASTIKA PRIMARY SCHOOL

LEVEL : PRIMARY 4

SUBJECT : MATH

TERM : 2019 SA2

BOOKLET A

Q 1	Q2	Q3	Q4	Q5	Q6	Q7	Q8	Q9	Q10
2	3	4	4	3	4	4	3	3	1
Q 11	Q12	Q13	Q14	Q15	Q 16	Q17	Q18	Q19	Q20
2	1	4	1	4	4	2	4	3	3

Q21)	9cm
Q22)	122 cm
Q23)	6
Q24)	$2700 + 1200 = 3900$ $3900 + 3150 = 7050$ $7050 + 2250 = \$9300$
Q25)	$150 - 1950 = \$1200$
Q26)	September and May
Q27)	\$2350
Q28)	Rachel
Q29)	25 min

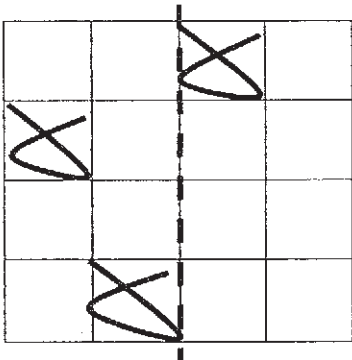
Q30)	$6 \times 6 = 36$ $72 + 36 = 108$ $108 \div 9 = 12 \text{ m}$
Q31)	9800
Q32)	11120
Q33)	6 and 9
Q34)	$\frac{1}{4}$
Q35)	$1\frac{4}{9}$
Q36)	$90^\circ - 28^\circ = 62^\circ$
Q37)	0.005
Q38)	$0.076, \frac{3}{5}, 0.700$
Q39)	$8.5 - 0.76 = 7.74$
Q40)	<p style="text-align: center;">A</p>  <p style="text-align: center;">B</p>

Q41)	$a) 600 - 150 = 450$ $b) 250 + 350 = 600$ $600 + 550 = 1150$ $1150 \times 6 = 6900$
Q42)	$23.20 + 12.40 = 35.60$ $35.60 \div 4 = \$8.90$
Q43)	$41.65 - 32.15 = 9.50$ $9.50 \times 4 = 38.00$ $41.65 - 38.00 = 3.65 \approx 3.7\text{kg}$
Q44)	$7 - 3 = 4$ $260 \div 4 = 65$ $65 \times 7 = \$455$
Q45)	$\frac{2}{3} \times 3 = \frac{6}{9}$ $5589 \div 9 = 621$ $5589 - 621 = 4968$ $521 \times 6 = 3726$ $4968 - 3726 = \$1242$
Q46)	$6074 - 1289 = 4785$ $4785 \div 5 = 957$ $957 \times 3 = 2871$
Q47)	$2 \times 54 = 108$ $108 \div 3 = 36$ $36 + 54 = 90$
Q48)	$16 \div 8 = 2$ $2 \times 3 = 6$ $6 \times 6 = 36\text{cm}^2$