



NANYANG PRIMARY SCHOOL

PRIMARY 4 SCIENCE

**SEMESTRAL ASSESSMENT 2
2017**

BOOKLET A

**Date : 30 Oct 2017
Duration : 1 h 45 min**

Name : _____ ()

Class: Primary 4 ()

**DO NOT OPEN THIS BOOKLET UNTIL YOU ARE TOLD TO DO SO.
FOLLOW ALL INSTRUCTIONS CAREFULLY.**

Booklet A consists of 19 printed pages including this cover page.

Section A (28 x 2 marks = 56 marks)

For each question from 1 to 28, four options are given. One of them is the correct answer. Make your choice (1, 2, 3 or 4). Shade the correct oval (1, 2, 3 or 4) on the Optical Answer Sheet provided.

1. Which one of the following is a living thing?

(1)



(2)



(3)



(4)



2. Study the chart below.

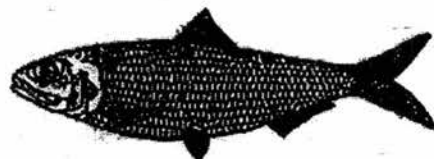
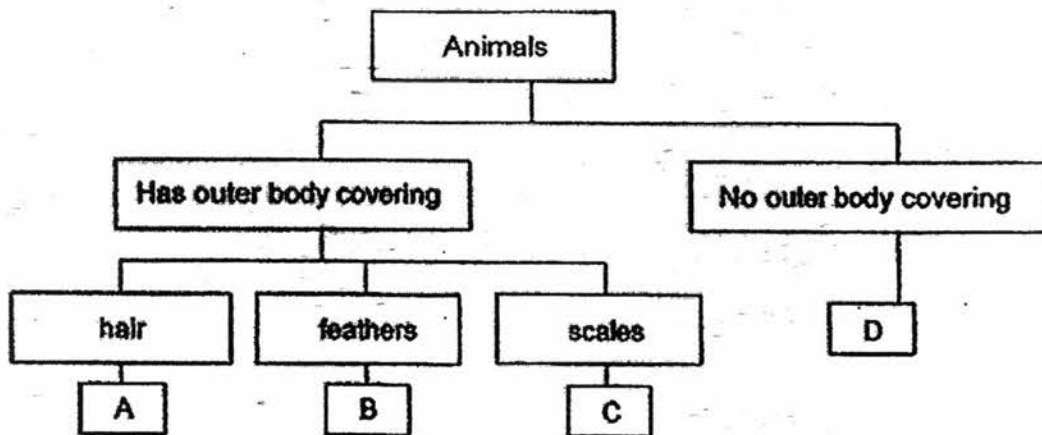

Where would you put this animal in the chart above?

(1) A
(3) C

(2) B
(4) D

3. The diagram below shows a young plant.

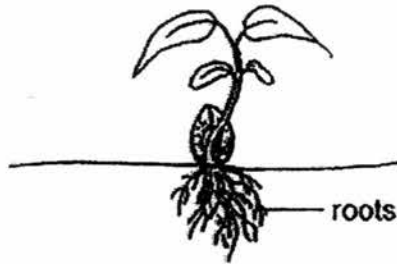

The roots help the plant to _____.

- (1) make food
 - (2) grow upright
 - (3) absorb water
 - (4) absorb sunlight
4. The diagram below shows the growth of a young plant with two missing stages P and Q.

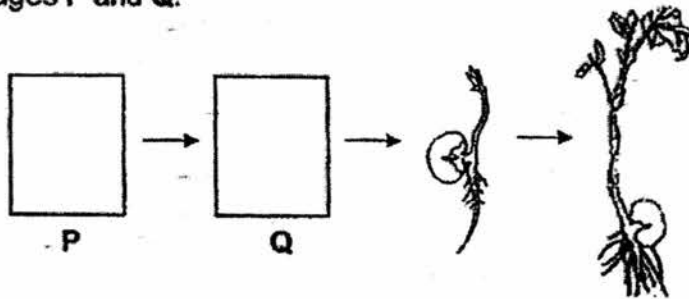

Which one of the following shows the correct stages for P and Q?

	P	Q
(1)		
(2)		
(3)		
(4)		

5. In which part of the digestive system is digestive juice produced?

- (1) anus
- (2) gullet
- (3) large intestine
- (4) small intestine

6. In which one of the following will the two magnets push each other away?

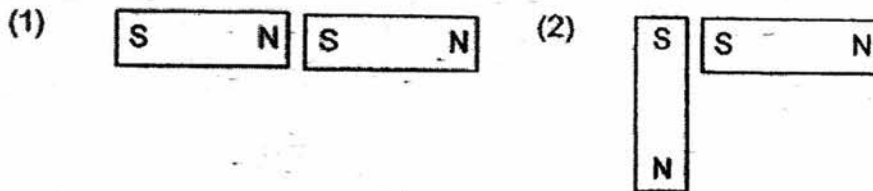

7. Xifen put a glass marble into a container of water.

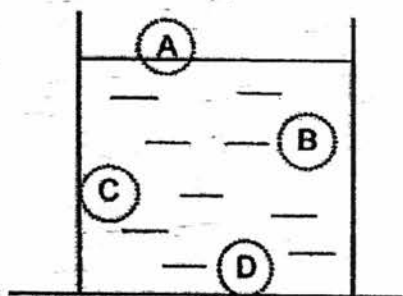

At which position, A, B, C or D, would the glass marble most likely be found?

- (1) A
- (2) B
- (3) C
- (4) D

8. Look at the diagram below.

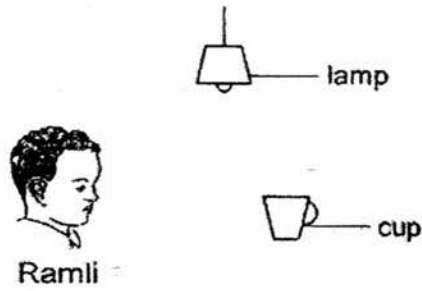

Which one of the following light ray diagrams shows why Ramli can see the cup?

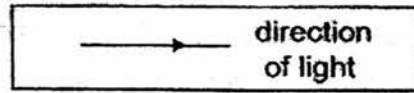

(1)

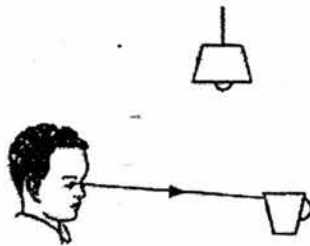

(2)

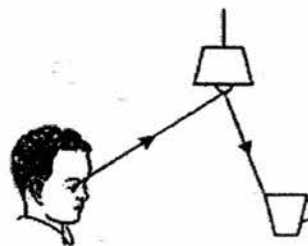

(3)

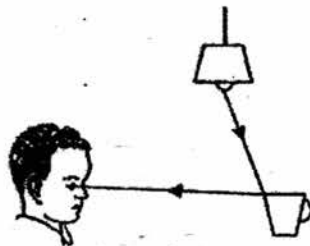

(4)

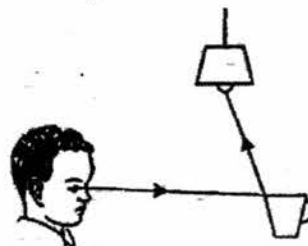

9. Which one of the following properties is true for both air and an eraser?

- (1) They can be seen.
- (2) They take up space.
- (3) They have definite shapes.
- (4) They have definite volumes.

10. Kenneth wants to measure the temperature of hot water in a beaker.

Which one of the following diagrams shows the correct position of the thermometer when taking the temperature reading?

(1)

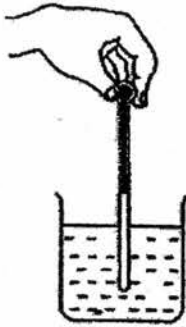

(2)

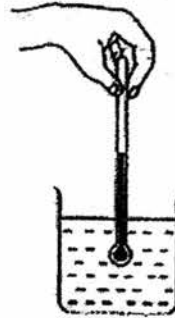

(3)

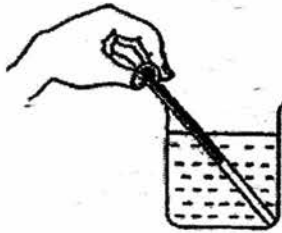

(4)



11. Rezal kept 4 guppies in a fish tank. A few weeks later he found 8 smaller sized guppies even though he had not added any more fish in the tank.

Which characteristic of living things does this observation show about the guppies?

- (1) Living things can grow.
- (2) Living things can reproduce.
- (3) Living things need air, food and water.
- (4) Living things can respond to changes in their surroundings.

12. The classification table below shows how plants can be classified.

Plants	
A	B
rose plant lemon tree papaya tree	bird's nest fern moss P

Which one of the following best represents headings A, B and example P?

	A	B	P
(1)	flowering plants	non-flowering plants	mushroom
(2)	non-flowering plant	flowering plants	ladder fern
(3)	plants with seeds	plants without seeds	mango tree
(4)	plants with seeds	plants without seeds	ladder fern

13. The flowchart below was used to classify four animals.

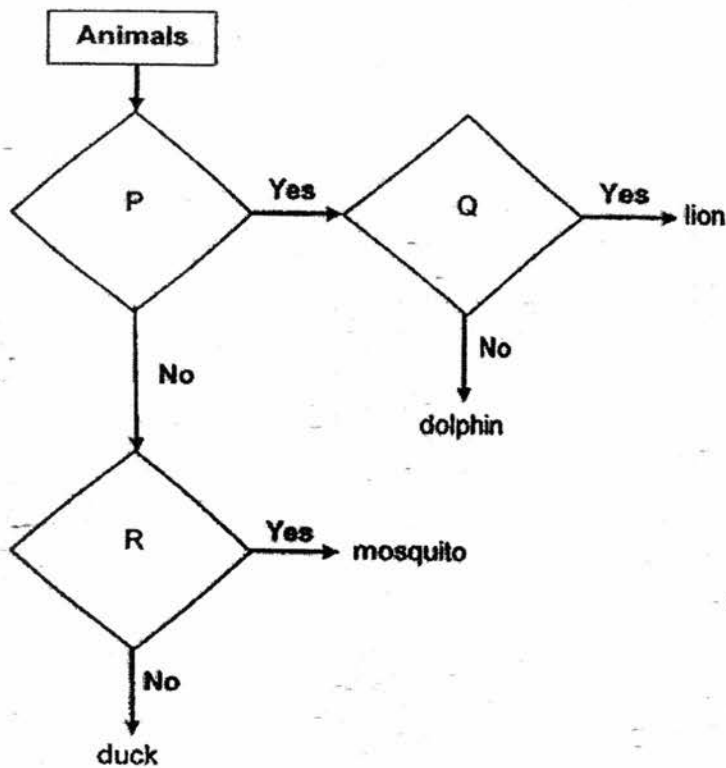

Based on the flowchart, which of the following questions best represent P, Q and R?

	P	Q	R
(1)	Does it live on land?	Does it have 6 legs?	Does it have hair?
(2)	Does it have 6 legs?	Does it live on land?	Does it have hair?
(3)	Does it have hair?	Does it live on land?	Does it have 6 legs?
(4)	Does it have hair?	Does it have 6 legs?	Does it live on land?

14. Four children made the following observations about micro-organisms.

- Alex Micro-organisms can all make their own food.
 Bala Micro-organisms are found in only one shape.
 Cathy Micro-organisms need air, food and water to survive.
 Deming Micro-organisms can only be seen under a microscope.

Who had made the correct statements?

- (1) Alex and Bala (2) Alex and Cathy
 (3) Bala and Deming (4) Cathy and Deming

15. Jonathan set up the experiments below. He filled 2 similar beakers with the same amount of water and put 2 similar plants in them. He had also removed the roots of the plant in Beaker B.

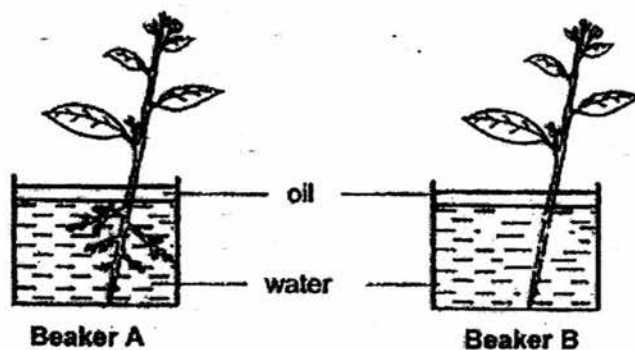

He recorded the volume of water in each beaker at the end of 3 days.

	Beakers	
	A	B
Volume of water at first (ml)	300	300
Volume of water after 3 days (ml)	X	Y

Which one of the following best represents the volume of water in the beakers after 3 days?

	X	Y
(1)	300	300
(2)	300	310
(3)	240	240
(4)	240	290

16. What are the two human organ systems represented by the diagrams below?

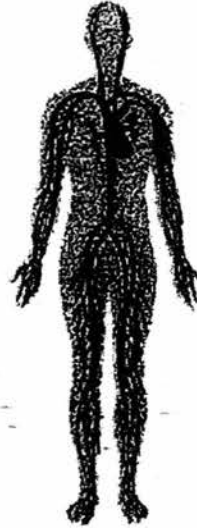
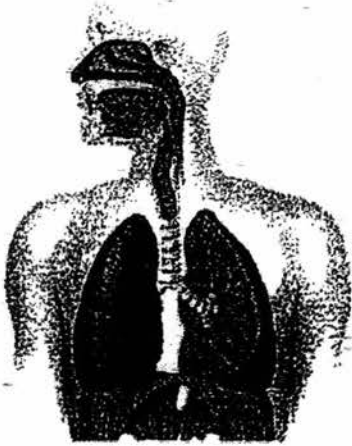

- (1) muscular and skeletal systems
- (2) muscular and circulatory systems
- (3) respiratory and digestive systems
- (4) respiratory and circulatory systems

17. Which of the following statement(s) is/are true about the human digestive system?

- A Food is digested in the mouth and gullet.
- B Digestive juices are produced in the small intestine only.
- C Water is absorbed from undigested food in the large intestine.

- (1) A only
- (2) C only
- (3) A and B only
- (4) B and C only

18. The diagram below shows the life cycle of insect X.

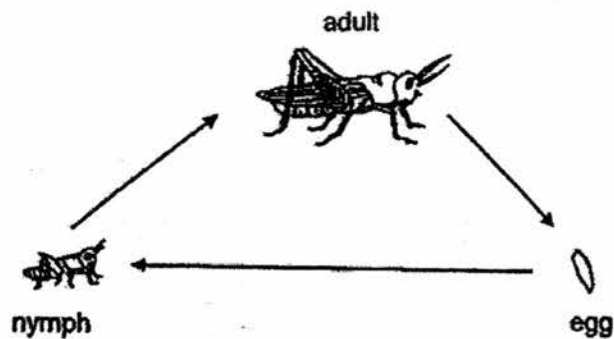

Which one of the following statements correctly describes the life cycle of insect X?

- (1) It has a 4-stage life cycle.
- (2) The young looks like the adult
- (3) The young is as big as the adult.
- (4) The young does not have a pair of feelers like the adult.

19. The graph below shows the number of days, insects G and H, spend at each stage of its life cycle.

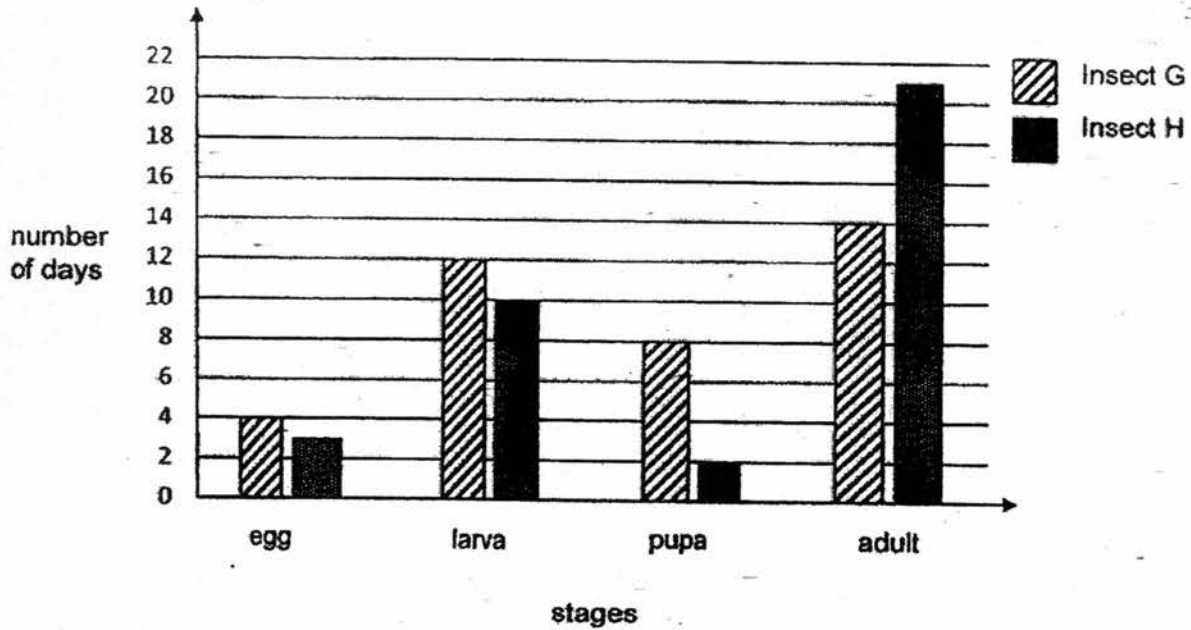

Based on the information in the graph, which one of the following statements is correct?

- (1) Insect G can be a beetle while insect H can be a cockroach.
- (2) Insect G and H spend the same number of days in the egg stage.
- (3) Insect H spends less number of days in the larva stage than insect G.
- (4) Insect H took more days to become an adult than insect G after the eggs are laid.

20. Noel wanted to find out how the position of the sun affects the length of the shadow. He placed a wooden stick in the field and observed its shadow when the sun was at 3 positions, A, B and C during the day as shown in the diagram below.

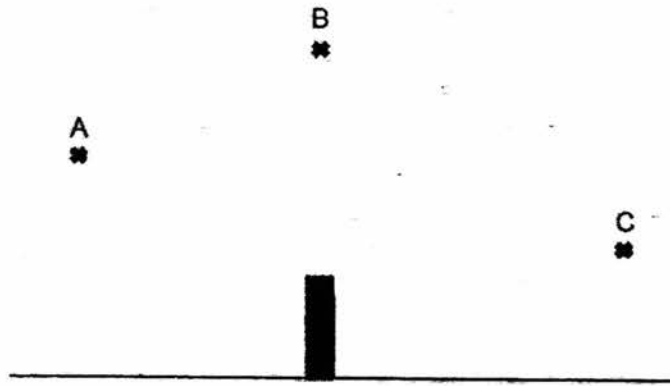

Based on the diagram above, which one of the following statements is true?

- (1) The sun shining at position B will form the longest shadow.
- (2) The sun shining at position C will form the shortest shadow.
- (3) The length of the shadow increases as the sun shifts its position from A to B.
- (4) The length of the shadow formed by the sun at position A will be shorter than at position C.

21. Wei Lin had three pieces of cards, C, D and E, made of different materials which allowed different amounts of light to pass through. They are of similar size and thickness. Card D has a hole in the centre.

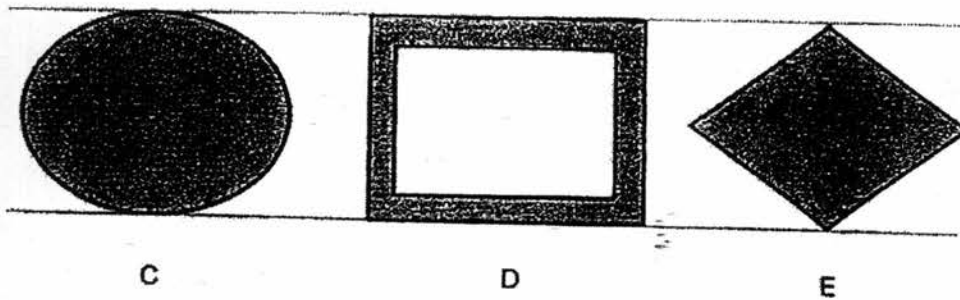

The set-up below shows light shining on the three cards which were arranged at different distances from the lamp.

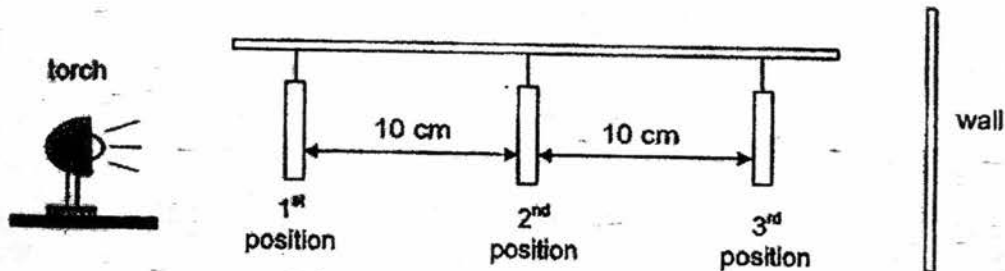

The diagram below shows the shadow that was formed on the wall.

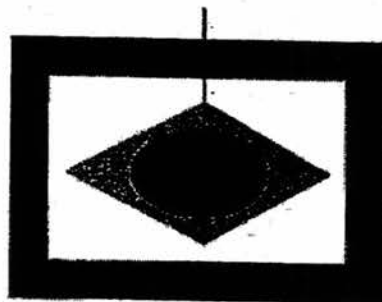

Based on the observation above, how had C, D and E been arranged in order to form the shadow?

	1 st position	2 nd position	3 rd position
(1)	D	C	E
(2)	D	E	C
(3)	C	E	D
(4)	E	D	C

22. Li Wei took out a tub of ice cream from the freezer and scooped some ice cream out into a metal bowl. He felt that the metal bowl became colder and observed that the ice cream had melted very quickly.

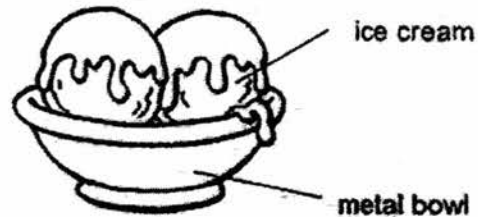

Which of the following reasons explained his observations?

	ice cream melted quickly	metal bowl became cold
(1)	ice cream gained heat from the surroundings	metal bowl gained heat from the ice cream
(2)	ice cream lost heat to the surroundings	metal bowl lost heat to the ice cream
(3)	ice cream gained heat from the surroundings	metal bowl lost heat to the ice cream
(4)	ice cream lost heat to the surroundings	metal bowl gained heat from the ice cream

23. Alice bought a cup of coffee and found that a cardboard sleeve was wrapped around the hot cup of coffee. It fits the plastic cup perfectly with no gaps in between.

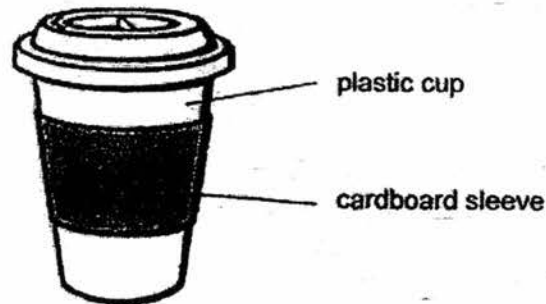

How does the cardboard sleeve enable Alice to hold the hot cup of coffee for a longer time?

- (1) The cardboard sleeve loses heat faster than the plastic cup to the surrounding air.
- (2) The cardboard sleeve causes the temperature of the coffee in the cup to decrease.
- (3) The cardboard sleeve does not allow heat to pass through from the plastic cup to Alice's hand.
- (4) The cardboard sleeve slows down heat transferred from the hot cup of coffee to Alice's hand.

24. Study the flow chart below.

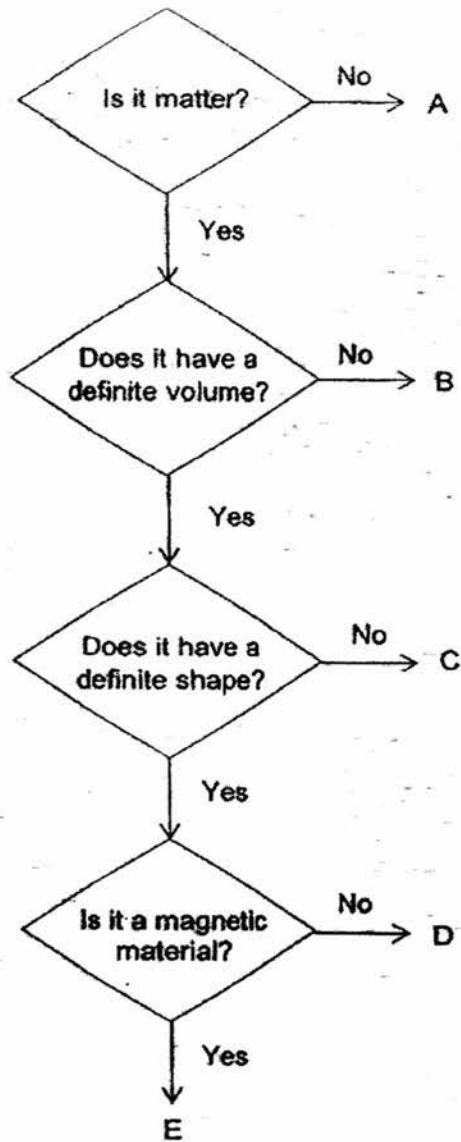

Which letters could correctly represent an aluminium rod, milk and sound?

	aluminium rod	milk	sound
(1)	C	D	B
(2)	D	C	A
(3)	D	B	C
(4)	E	C	A

25. The beaker shown below contains 200 cm^3 of water at first. Charlie placed object A and B into the beaker one at a time and the volume was recorded each time. When both objects were placed into the beaker, the total volume in the beaker was 320 cm^3 .

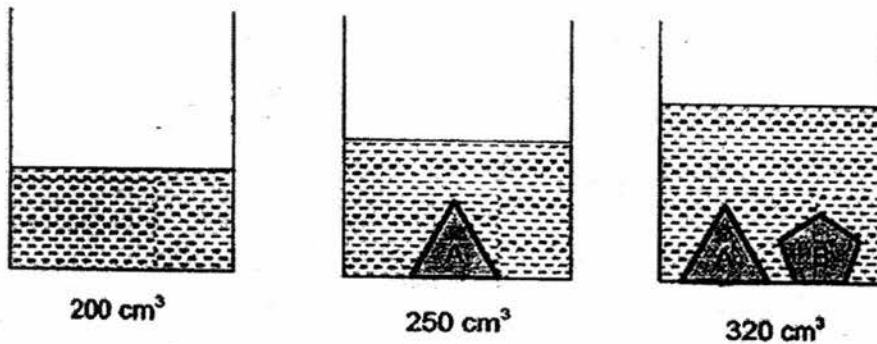

Based on the experiment above, Charlie made a few conclusions.

- A Object A has a volume of 70 cm^3 .
- B Object A and B have a definite volume.
- C Object B has a greater volume than object A.

Which of his conclusions are correct?

- (1) A and B only
 - (2) A and C only
 - (3) B and C only
 - (4) A, B and C
26. Govind wants to build a small toy boat similar to the one in the picture below.

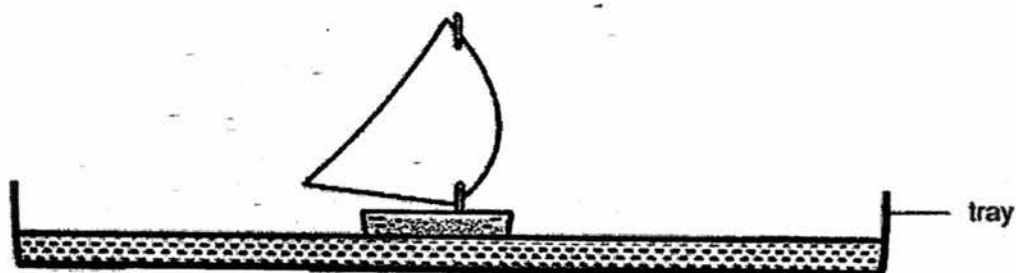

Which property of material is the most important for him to consider in order for the toy boat to work properly?

- (1) Transparency
- (2) Ability to float
- (3) Strength
- (4) Flexibility

27. Which one of the following statements about magnets is false?

- (1) Magnets have north and south poles.
- (2) The bigger a magnet, the stronger it is.
- (3) The like poles of a magnet repel each other.
- (4) The unlike poles of a magnet attract each other.

28. Katherine observed the door of the teachers' staff room closely. She noticed that when it was closed, a metal plate and a magnet kept the door firmly locked. In order to open the door, she has to press an electrical switch.

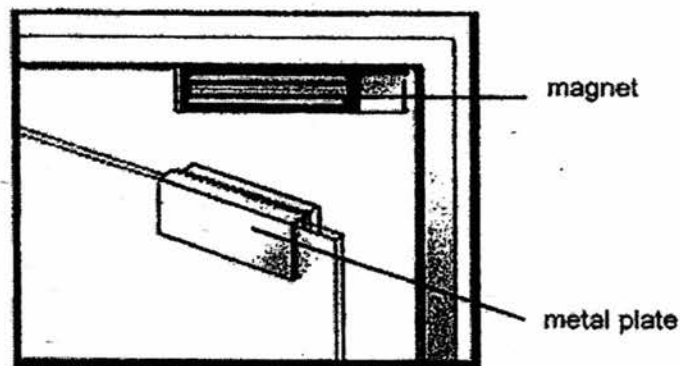

Based on her observations, Katherine made the following conclusions. Which one of her conclusions is false?

- (1) The magnet is an electromagnet.
- (2) The metal plate is made of a magnetic material.
- (3) When the switch is pressed, the magnet attracts the plate.
- (4) When the switch is pressed, the magnet does not attract the plate.



NANYANG PRIMARY SCHOOL

PRIMARY 4 SCIENCE

**SEMESTRAL ASSESSMENT 2
2017**

BOOKLET B

Date : 30 Oct 2017

Duration : 1 h 45 min

Name : _____ ()

Class: Primary 4 ()

Marks Scored:

Booklet A:		56
Booklet B :		44
Total :		100

Any query on marks awarded should be raised by 8 Nov 2017. We seek your understanding in this matter as any delay in the confirmation of marks will lead to delays in the generation of results.

Parent's signature:

**DO NOT OPEN THIS BOOKLET UNTIL YOU ARE TOLD TO DO SO.
FOLLOW ALL INSTRUCTIONS CAREFULLY.**

Booklet B consists of 13 printed pages including this cover page.

Section B (44 marks)

Write your answers to questions 29 to 41 in the spaces provided.

29. Fill in the correct parts of a plant in the table.

[2]

Function of plant part	Plant part
(a) It holds the plant upright.	
(b) It makes food for the plant.	

30. Devi places a magnet near a steel clip. The steel clip moves towards the magnet.

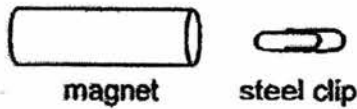

(a) The magnet exerts a _____ on the steel clip.

[1]

Choose the correct word from the box to answer the question below.

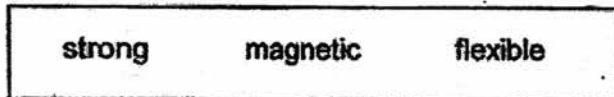

(b) Devi's observation shows that steel is a _____ material.

[1]

31. Look at the pictures. Tick (✓) the sources of light.

[2]

magnifying glass



sun



candle flame

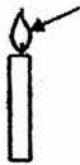

mirror



32. Lily placed a metal rod and a wooden rod into a tank of boiling water as shown below. Equal amounts of wax were put on both rods.

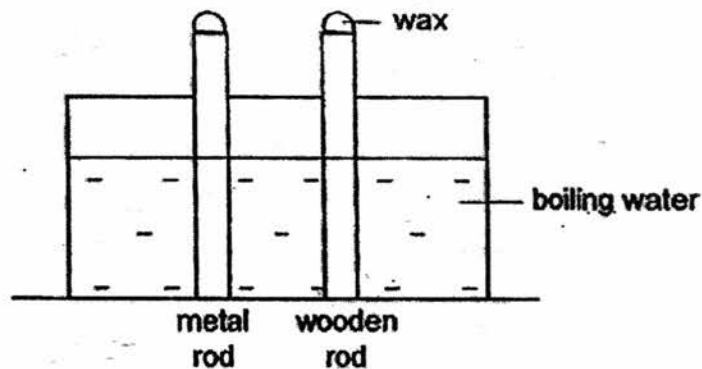

What would she observe and why?

[2]

The wax on the metal rod melted _____ than the wax on the wooden rod, as metal is a _____ conductor of heat than wood.

33. Rashid compares the mass of three fruits.

Study the diagrams below and circle the correct comparison.

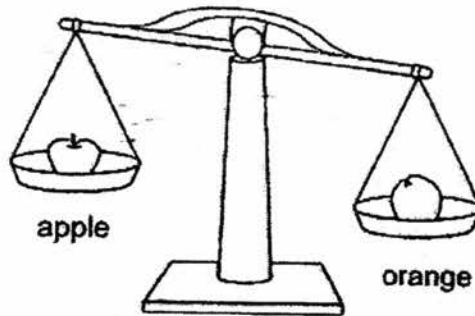

- (a) The orange is heavier than / 'has the same mass as' / 'is lighter than' the apple.

[1]

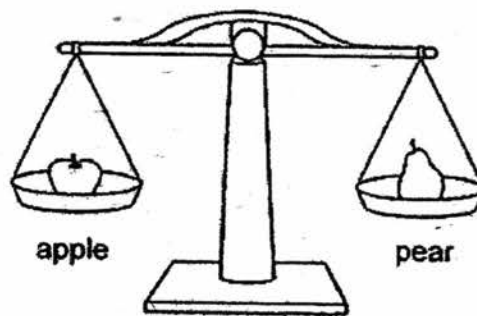

- (b) The apple 'is heavier than' / has the same mass as / 'is lighter than' the pear.

[1]

34. Catelyn compared two potted plants which did not have any flowers.



Catelyn found something on the leaves of plant A which led her to conclude that it was a fern.

(a) What did Catelyn find? [1]

A month later, Catelyn observed that Plant B had produced fruits. She then drew the following flowchart.

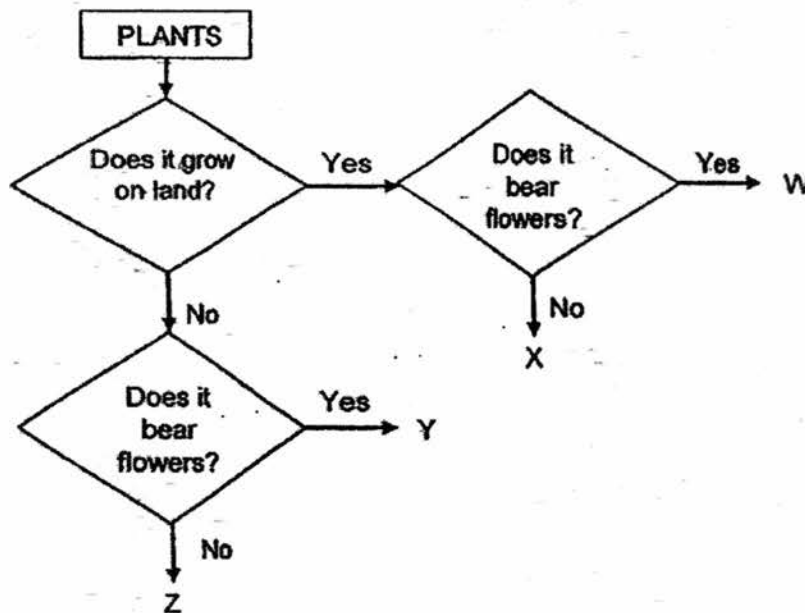

(b) Based on her observations, which letters, W, X, Y or Z, best represent Plant A and B in the flowchart above? [2]

Plant A : _____

Plant B : _____

(c) Based on the flowchart above, state all the characteristics of Plant Y. [1]

35. Study the classification table below.

- (a) Complete the headings of the table by identifying the animal groups. [2]

sparrow ostrich eagle	mudskipper salmon shark	salamander frog toad	crocodile lizard turtle

Michael captured an animal with 6 legs and 2 feelers.

- (b) Which animal group would this animal belong to? [1]

Michael observed animal A. It gives birth to its young alive, breathes through lungs and produces milk for its young.

- (c) What is the body covering of animal A? [1]

36. Jennifer found "white spots" growing on her leather purse. With the help of her Science teacher, she looked at the "white spots" under a microscope and saw the following image.



- (a) Based on Jennifer's observation, which group of living things was growing on the purse? [1]

Jennifer was upset to find the "white spots" because she had kept her leather purse carefully in a closed drawer.

- (b) How does the "white spots" above obtain its food to survive if it was kept in a closed drawer? [1]

Jennifer's teacher cleaned her purse and gave her the small packet shown below to put with her purse in the drawer. She said that it would prevent more "white spots" from appearing.



- (c) Explain how the packet helps to prevent the "white spots" from appearing. [2]

37. Study the diagram below carefully.

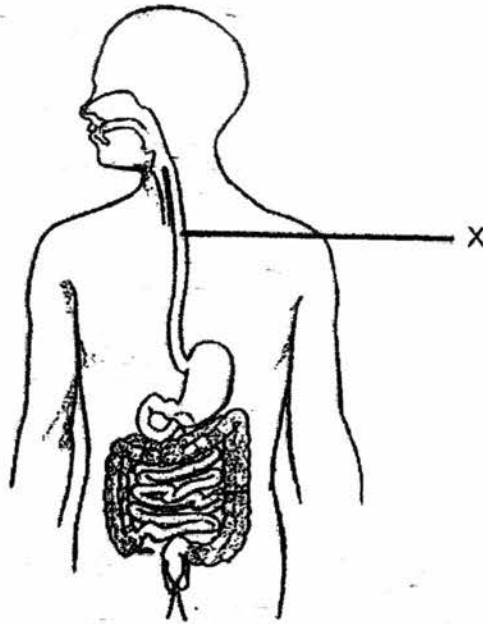

(a) Label the small intestine in the diagram above. [1]

(bi) What is the name of the part labelled X? [1]

(bii) State the function of part X in the digestive system. [1]

The food and nutrients in the digestive system are absorbed and passed from the small intestine directly to another human system.

(c) Identify the human system that works closely with the small intestine. [1]

38. The table below shows the characteristics of three animals, W, X and Y.

Characteristics	Animal		
	W	X	Y
The adult has six legs.	Yes	No	Yes
The young looks like the adult.	No	No	No
The adult lays eggs on plants.	Yes	No	No
The animal spends all life stages on land only.	Yes	No	No

(a) Based on the information in the table, state the difference between animal X and Y. [1]

(b) Based on the characteristics above, which animal is most likely to be a frog? Give a reason for your choice. [1]

Samuel concluded that a cockroach is an example of animal Y.

(c) Based on all the characteristics in the table, explain whether Samuel had given a correct example of animal Y. [2]

(d) Based on the characteristics in the table above, give an example of animal W. [1]

39. Ethan created two electromagnets using two batteries, some wire and two nails. He coiled the wire 20 times around each nail. He then tested his electromagnets and observed that set-up P could pick up more steel clips than set-up Q.

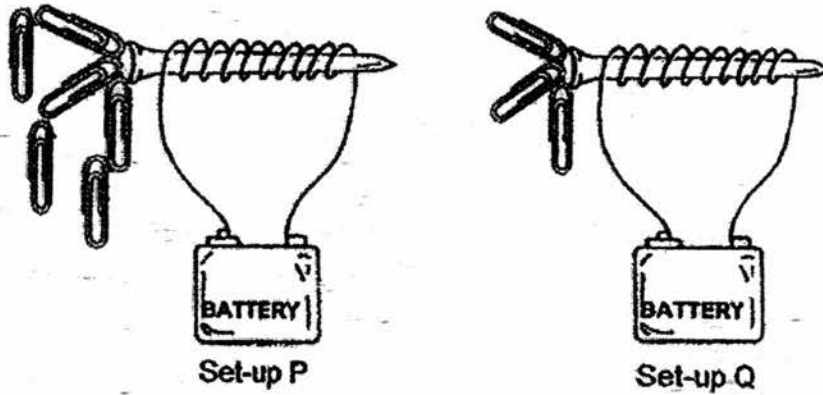

- (a) What is the most likely reason that one electromagnet could attract more paper clips than the other? [1]

- (b) Describe two ways in which Ethan could increase the number of metal paper clips which are attracted to the electromagnets. [2]

(i) _____

(ii) _____

- (c) Describe another method which Ethan could use to create a temporary magnet. [1]

40. Sharon had a beaker of coloured water and a straw. She placed one finger firmly on top of the straw and lifted it slowly. She noticed that the coloured water did not flow out from the straw as shown in the diagram below.

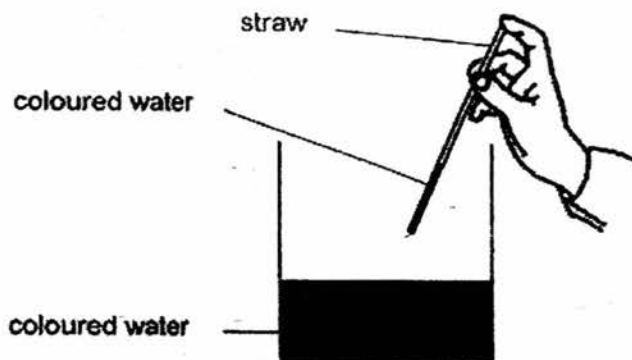

- (a) Explain why the coloured water did not flow out from the straw. [2]

- (b) State the property of liquid demonstrated in (a). [1]

Sharon did an experiment using soil as shown in the diagram below.

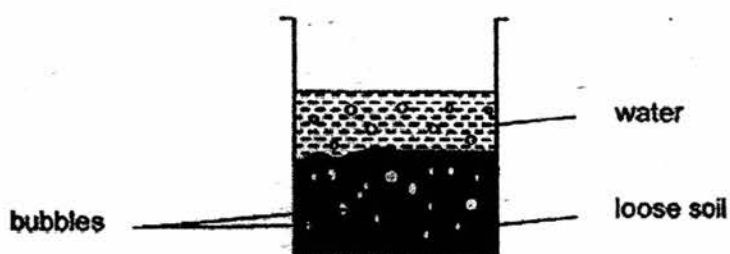

When she pours water into the loose soil, she observed that bubbles were seen bubbling out.

- (c) Give a reason for her observation. [1]

41. Mrs Lim set up a buffet table at home. She wanted to keep the food warm for her guests. First, she added water into the water tray and placed the tray on the stand. She then placed a lit candle under the tray as shown below. Both water trays are of the same size.

She poured 500 ml of water into water tray L and 800 ml of water into water tray M. Both water trays were heated at the same time and left to boil.

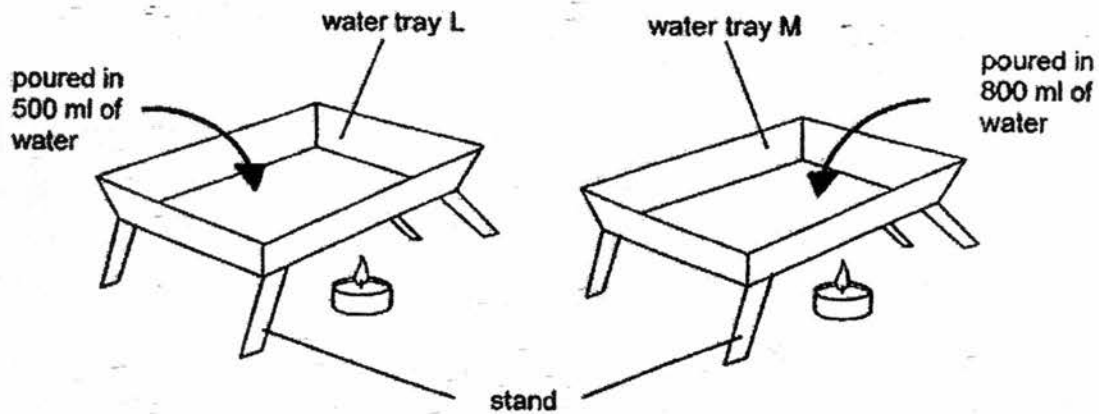

- (a) Which water tray, L or M, would have a greater amount of heat when the water started to boil? Explain your answer. [1]

After filling the water tray, the food tray containing food was placed on top of it.

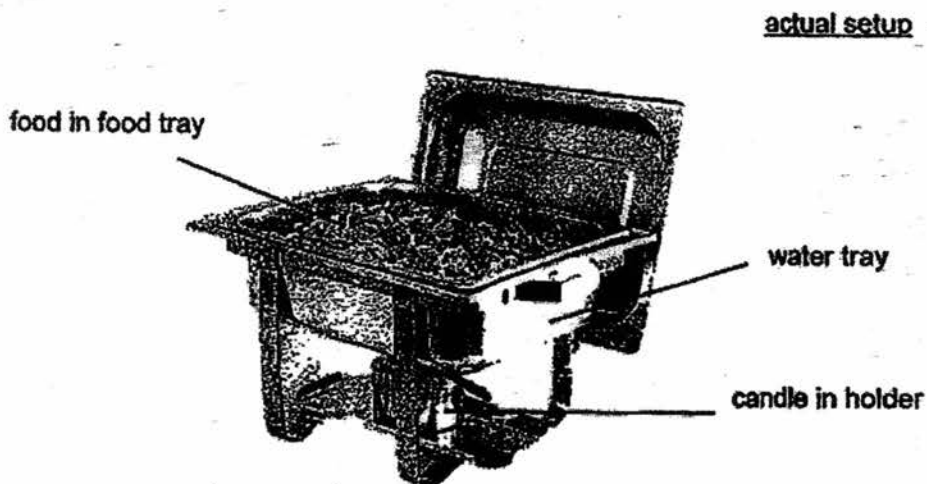

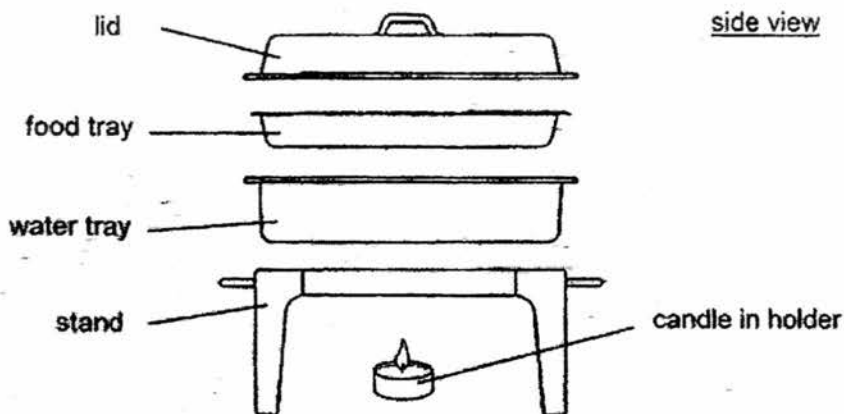

With the above set-up, food can be kept warm for a few hours.

- (bi) Explain, in terms of heat gain or heat loss, how the hot water transfers heat to the food to keep the food warm. [2]

- (bii) Suggest a suitable material to make the water tray and explain your answer. [1]

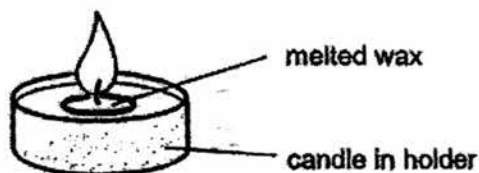

Mrs Lim noticed that the melted wax of the candle hardens after she blew out the flame.

- (c) Give a reason why it hardens after some time. [1]

End of paper

SCHOOL : NANYANG PRIMARY SCHOOL

LEVEL : PRIMARY 4

SUBJECT : SCIENCE

TERM : 2017 SA2

CONTACT :

SECTION A

Q 1	Q2	Q3	Q4	Q5	Q6	Q7	Q8	Q9	Q10
2	3	3	2	4	2	4	3	2	2
Q 11	Q12	Q13	Q14	Q15	Q16	Q17	Q18	Q19	Q20
2	4	3	4	4	4	2	2	3	4
Q 21	Q22	Q23	Q24	Q25	Q 26	Q27	Q28		
2	3	4	2	3	2	2	3		

SECTION B

Q29)	(a) Stem (b) Leaf
Q30)	(a) Force (b) Magnetic
Q31)	Sun, candle flame
Q32)	Faster, better
Q33)	Is heavier than, has the same mass as
Q34)	(a) Spore bags (b) X,W (c) It does not grow on land and bears flowers
Q35)	(a) Bird, Fish, Amphibian, Reptile (b) Insect (c) hair
Q36)	(a) fungi (b) it feeds on the leather purse (c) The "white spots" are actually mould, they need moisture, food and

	air to grow. If Jennifer place the "dry-packs" into her closed drawer, the mould not have any moisture to grow.
Q37)	<p>(a) -</p> <p>(b) i. gullet ii. it transport partially digested food from the mouth to stomach.</p> <p>(c) Circulatory system.</p>
Q38)	<p>(a) The adult of animal Y has six legs while the adult of animal X does not have six legs.</p> <p>(b) Animal X. Both animal X and frog does not have 6 legs.</p> <p>(c) No. The young of animal X does not look like its adult but the cockroach's young looks like its adult. Animal Y does not spend all its life stages on land only but cockroach spends all its life stages on land only.</p> <p>(d) Butterfly.</p>
Q39)	<p>(a) The battery was stronger in set-up P than in set-up Q.</p> <p>(b) i. Increase the number of coils of wire around the nail. ii. Add more batteries into the closed circuit.</p> <p>(c) Stroking method.</p>
Q40)	<p>(a) The finger prevented the air from entering the straw to push out the coloured water.</p> <p>(b) Liquid takes up space</p> <p>(c) The water seep into the air spaces between the soil particles and displace the air there.</p>
Q41)	<p>(a) Tray M. As it will take more heat to boil as there is more water and therefore would have a greater amount of heat when it started to boil.</p> <p>(b) i. Food tray gains heat from the hot water in the water tray. Food gains heat from the food tray. ii. Metal, as metal is a good conductor of heat and will pass the heat faster to the food tray.</p> <p>(c) The melted wax lost heat to the surrounding and turned into a solid.</p>

Nanyang

Name : _____

Class : _____

Analysis of selected open-ended questions 2017 P4 Science SA2

34c) Tested : Understanding of flowchart.

NB : Use the exact wordings in the flowchart.

Answer : Plant Y does not grow on land and bears flowers.

36) Concept : Fungi obtain food from the organism that they grow on. They grow well in environment that are moist.

Misconception : Fungi grow well in dark places.

36b) It obtains food from the leather purse.

NB : Generic answer is not acceptable. Eg. Fungi get food from the living or dead organism that they grow on.

36c) The packet absorbs/removes the moisture in the drawer (*purpose of the packet*) and the fungi could not grow as it needs moisture to grow/survive (*identifying correct condition for fungi to grow under this situation*)

38) Tested : Answering Technique of stating similarities and differences

38a) Animal X does not have 6 legs but Animal Y has 6 legs. (must show comparison)

38b) Animal X. Both Animal X and frog does not have 6 legs.

NB : To state similarities between 2 animals – Start answer with "Both".

38c) No. Young of Animal Y does not look like its adult but the cockroach's young looks like its adult. Animal Y does not spend all its life stages on land only but cockroach spends all its life stages on land only.

NB : Out of all the characteristics stated, pupils need to identify the correct characteristics to support their choice. The answer required 2 differences to be stated.

40a) The finger prevented the air from entering the straw to push out the coloured water.

Concept tested : Reverse concept of air escaping a container to allow water to enter.

40c) The water will seep into the air spaces between the soil particles and displace the air there.

41b) Food tray gains heat from the hot water in the water tray. Food gains heat from the food tray.

NB : must state how heat travels from the place to another

41c) Concept tested : Losing/ gaining heat can result in change of state.

Answer : The wax lost heat to the surroundings and hardens.