

SINGAPORE CHINESE GIRLS' SCHOOL (PRIMARY)
SECOND SEMESTRAL ASSESSMENT 2008
PRIMARY 4 SCIENCE

Name: _____ ()

Class: Primary 4 S / C / G / SE / P

Date: _____

Duration: 1h 15min

Part I (40 marks)

For each question from 1 to 20, four options are given. One of them is the correct answer. Make your choice (1, 2, 3 or 4). Shade the correct oval (1, 2, 3 or 4) in the Optical Answer Sheet.

1. 2 animals, A and B, were observed and their characteristics were recorded in the table below.

Characteristics	Animal A	Animal B
Moults	✓	
Lays eggs	✓	✓
Has hair		✓

Which of the following could represent Animals A and B respectively?

	Animal A	Animal B
1)	Caterpillar	Platypus
2)	Cockroach	Lion
3)	Grasshopper	Crocodile
4)	Wiggler	Camel

2. Some animals have been placed into 3 groups.

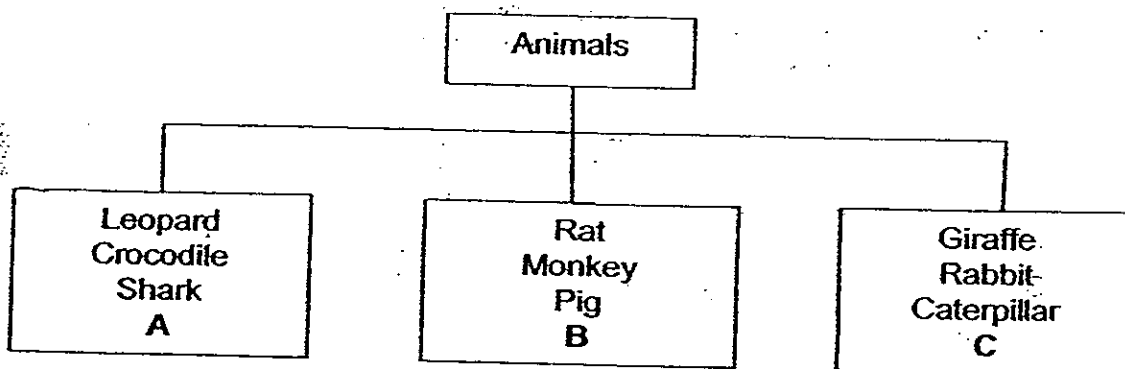

Which of the following best represents the animals A, B and C?

	A	B	C
1)	Cat	Boy	Dog
2)	Tiger	Sheep	Flamingo
3)	Panda	Bear	Crab
4)	Hyena	Chicken	Deer

3. The following objects can be made from 2 different materials. Which of the following objects has been matched **wrongly**?

	Objects	Materials
1)	Ruler	Plastic, Wood
2)	Skirt	Cotton, Silk
3)	Key	Glass, Rubber
4)	Container	Copper, Glass

4. Ali made the following statements about the human body systems.

- A: A human being has only 2 body systems.
 B: Water is removed in the small intestine.
 C: Blood vessels are part of the respiratory system.
 D: The skeletal and the muscular systems work together to allow movement.

Which of the above statement(s) is/are true of the human body systems?

- 1) B only
 2) D only
 3) A, B and C only
 4) B, C and D only

5. Which of the following is **NOT** true?

	Plant Parts	Functions
1)	Leaves	Make food for the plant
2)	Leaf stalk	Holds up leaves
3)	Roots	Transport water and minerals
4)	Stem	Allows plant to stand upright

6. Mariam conducted a test to find out the strength of 4 magnets. She picked up paper clips using 4 identical bar magnets. The results were then tabulated in the table below.

Magnets	Distance between one pole of magnet and dish of paper clips	Number of clips attracted
A	5 cm	5
B	10 cm	9
C	3 cm	2
D	11 cm	13

Arrange the magnets from the weakest to the strongest.

- 1) A, C, B, D
 2) C, A, B, D
 3) B, D, A, C
 4) C, A, D, B

7. Jane carried out the following experiment to find out the property of some materials. She then recorded her results in the table below.

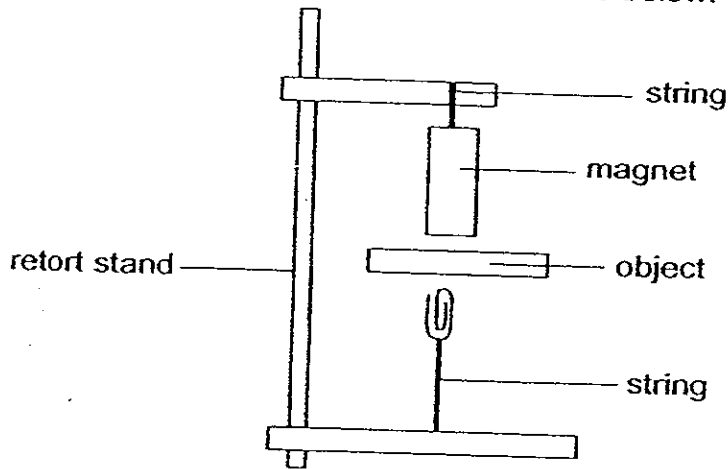

Objects	Paper clip attracted to magnet
Aluminium sheet	Yes -
Cloth	Yes
Paper	Yes
Plastic file	Yes
Stainless steel plate	No

Based on her results, which of the following could be her conclusion?

- 1) Metals allow magnetism to pass through them.
 - 2) Only non-metals allow magnetism to pass through them.
 - 3) Non-magnetic materials allow magnetism to pass through them.
 - 4) No conclusion could be reached because the experiment was a failure.
8. Some animals have been put into 3 groups, X, Y and Z based on the number of stages in their life cycles.

Group X	Group Y	Group Z
Chimpanzee	Mosquito	Damselfly
Panther	Cockroach	Butterfly
Man	Dragonfly	Mealworm beetle

Which animals have been classified wrongly?

- 1) Panther, Butterfly
- 2) Mosquito, Damselfly
- 3) Chimpanzee, Cockroach
- 4) Dragonfly, Mealworm beetle

9. Below is the life cycle of a plant.

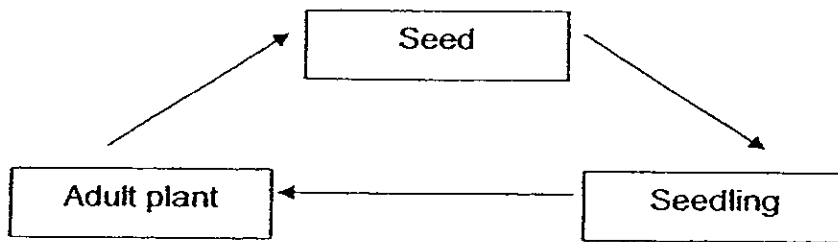

Which of the following plants have a similar life cycle as above?

- 1) Bean plant, Mould
- 2) Tomato plant, Chilli plant
- 3) Maidenhair fern, Toadstool
- 4) Onion plant, Shitake mushroom

10. The items below are at room temperature. Which of the following states of matter correctly represents these items?

	Solid	Liquid	Gas
1)	Juice	Wax	Nitrogen
2)	Pencil	Oxygen	Alcohol
3)	Granite	Petrol	Carbon dioxide
4)	Nitrogen	Milk	Coffee beans

11. Salleh was given 4 different objects, R, S, T and U. He scratched the four objects one against the other. He then wrote down his observations as follows.

- T could scratch R.
- S could scratch U
- R could scratch S

Based on his observations, which of the following statements is correct?

- 1) T is harder than S.
- 2) U is harder than R.
- 3) S is harder than R.
- 4) R is the hardest of the four objects.

12. Ali placed a beaker of water over a flame and brought it to a boil and kept it boiling for some time. He noted the temperature changes and plotted them on a graph.

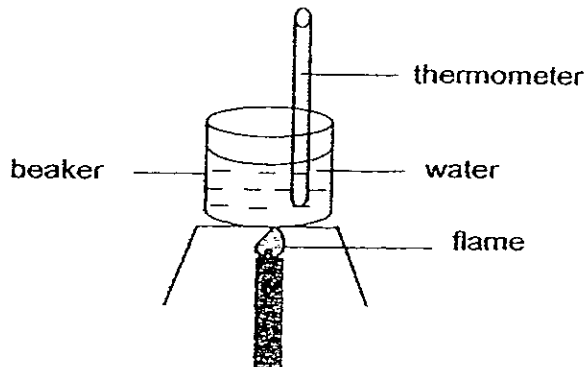

Which graph best represents the temperature changes?

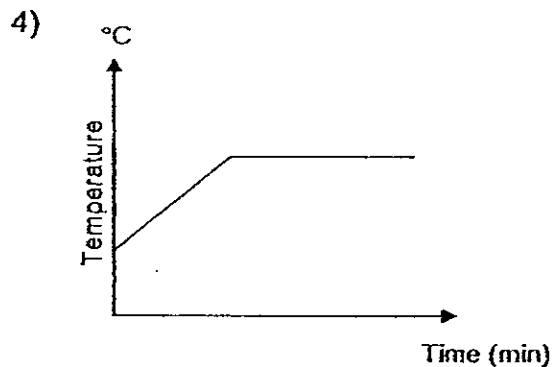
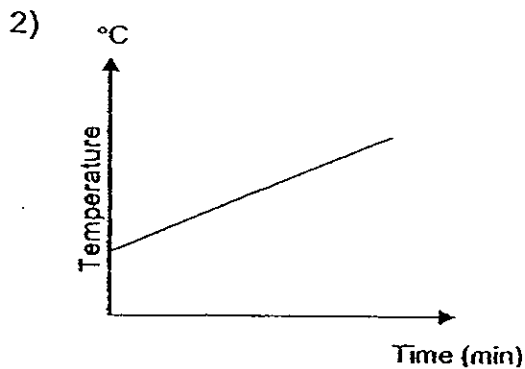
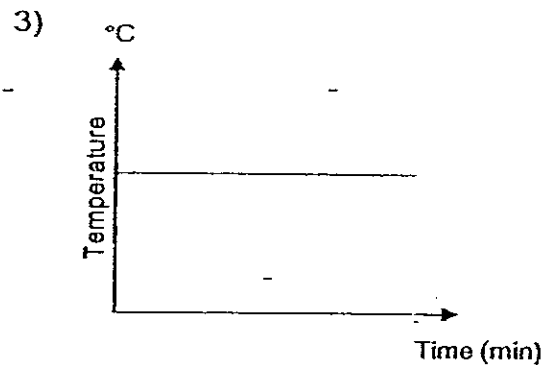
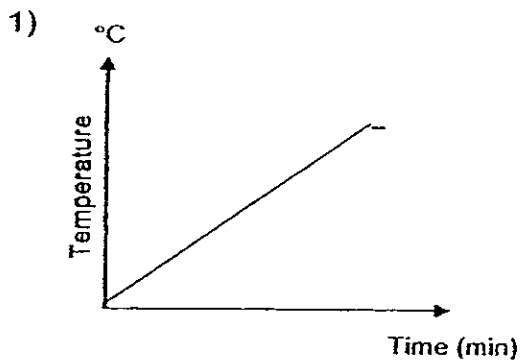

13. Kathleen wanted to enable some ice blocks that were on a table in a room to remain in the solid state for the longest time possible. She listed some actions she could take to achieve the above.

- A: Place some salt on the ice blocks.
- B: Place the ice blocks under a flagpole.
- C: Place some sawdust on the ice blocks.
- D: Place the ice blocks in a Styrofoam box.

Which actions will help her achieve the desired outcome?

- 1) A and B
- 2) A and D
- 3) B and C
- 4) C and D

Study the classification chart below carefully and answer Questions 14 and 15.

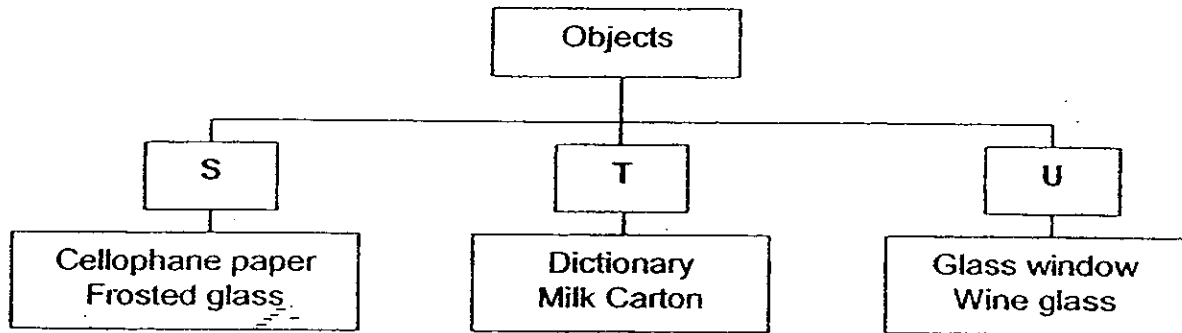

14. The above objects have been classified according to _____.

- 1) size
- 2) shape
- 3) degree of hardness
- 4) degree of transparency

15. Which of the following objects can be classified under S, T and U respectively?

	S	T	U
1)	Blue ring file	Printer	Plastic sheet
2)	Tracing paper	Digital camera	Cling wrap sheet
3)	Tracing paper	Plastic sheet	Printer
4)	Goblet	Cupboard	Ceramic plate

16. Below are diagrams of a periscope, an instrument which allows us to see objects from a concealed position. Which of the diagrams shows the correct light path so that the object can be seen at the other end?

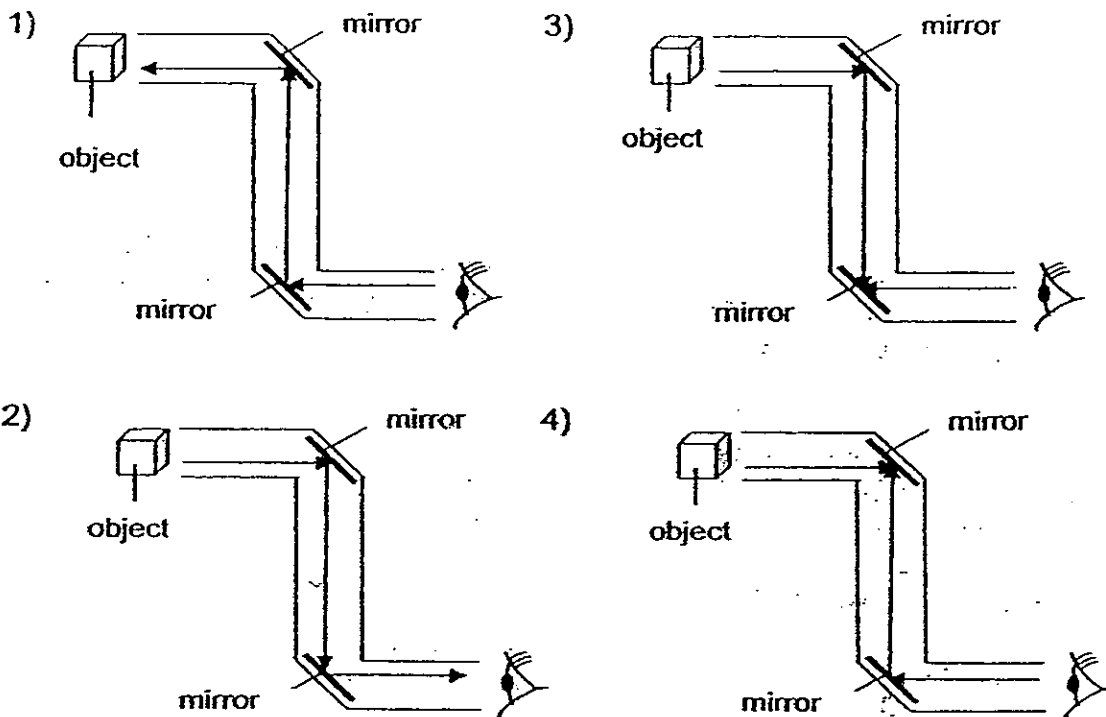

17. Kevin recorded the length of the shadows of a tree at different times of the day. Which graph best depicts the length of the shadows that was recorded?

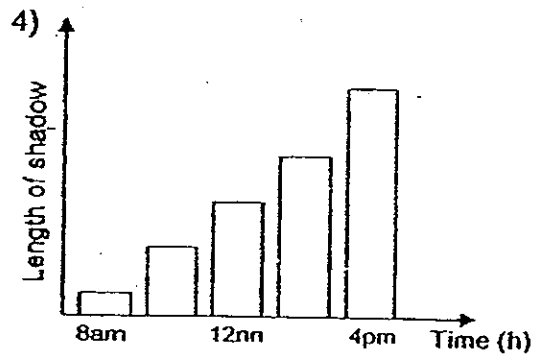
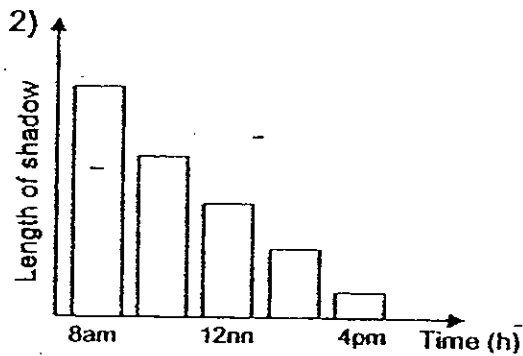
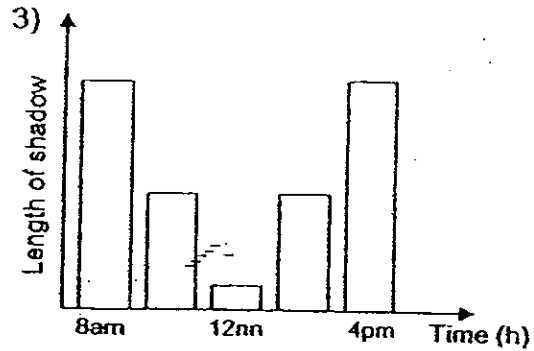
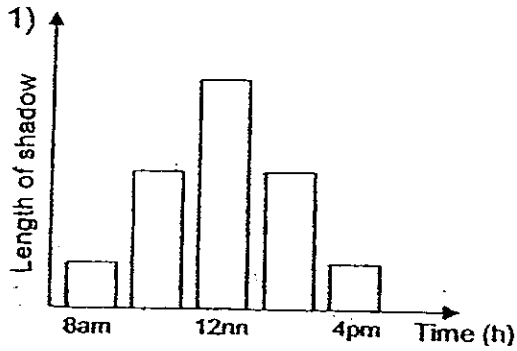

18. All of the following are sources of heat except _____

- | | |
|---------------------|---------|
| 1) geysers | 3) fire |
| 2) electric toaster | 4) wind |

19. Which of the following is a correct match between a thermometer's temperature range and its purpose?

Temperature range	To find the temperature of
X -10°C to 110°C	Boiling water
X 20°C to 60°C	Ice cube
X 40°C to 100°C	Human body
X 30°C to 45°C	Ice cream

20: Alan conducted an experiment to find out the relationship between the number of times he rubbed his hands and the time taken by ice cubes to melt when they were held in his hands.

Rubbing hands	5 times	10 times	15 times	20 times
Time taken for ice cubes to melt	5 minutes	3.5 minutes	2.5 minutes	1 minute

Which of the following statements about the experiment is **true**?

- 1) Heat and light energy were produced during the experiment.
- 2) It was not a fair test as the number of times Alan rubbed his hands were changed.
- 3) The approximate time taken for the ice cubes to melt if Alan rubbed his hands 13 times is 2.3 minutes.
- 4) The greater the number of times Alan rubbed his hands, the lesser the time taken for ice cubes to melt.

SINGAPORE CHINESE GIRLS' SCHOOL (PRIMARY)
SECOND SEMESTRAL ASSESSMENT 2008
PRIMARY 4 SCIENCE

Name: _____ ()
 Class: Primary 4 SY/C/G/SE/P

Date: _____
 Duration: 1h 15min

Components	Marks Obtained	Possible Marks
Part I		40
Part II		20
Total		60

Parent's Signature:

Part II (20 marks)

Read and answer Questions 21 to 28.

21. Study the graph below carefully. It shows the number of leaves on Plant Z over 6 weeks.

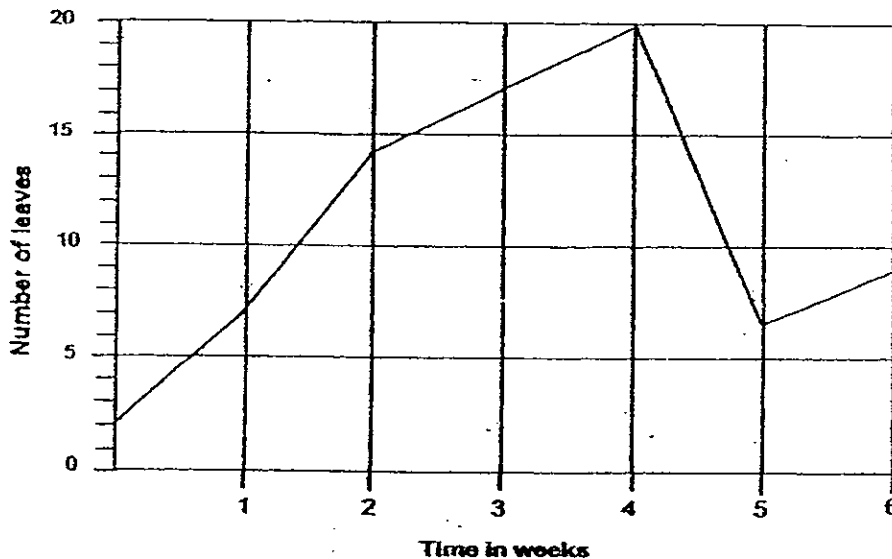

a) During which week did Plant Z grow the most number of leaves? (1m)

b) During week 5, there was a sudden drop in the number of leaves on Plant Z. Provide a possible explanation for this. (1m)

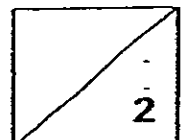

22. Karyn placed some animals in an enclosed tank as shown below. She placed 2 sensors to track the changes in the oxygen and carbon dioxide levels in the tank. The experiment was carried out for 4 hours. The readings from the sensors were plotted in the graph below.

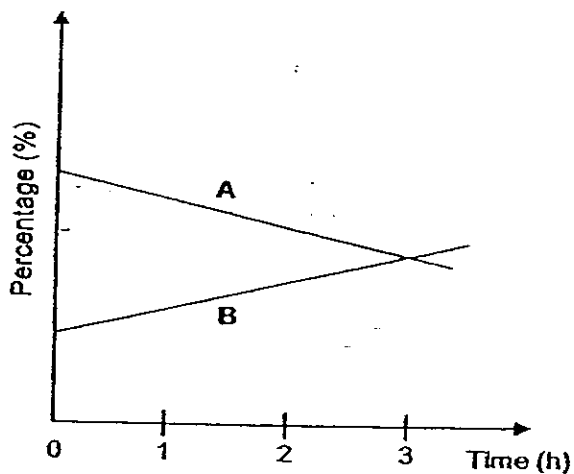
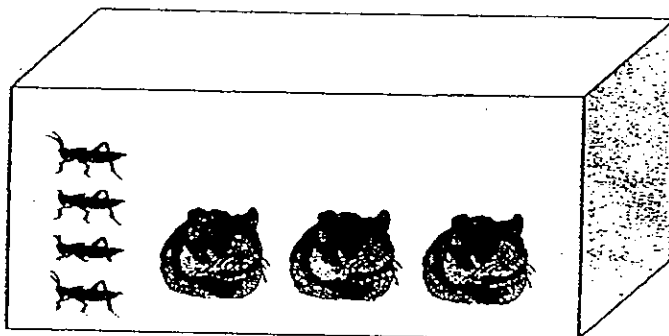

- a. Which graph represents the oxygen and carbon dioxide levels respectively? (2m)

Oxygen level	
Carbon dioxide level	

- b. Name the process that resulted in the above graphs. (1m)

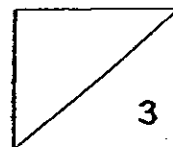

23. Jimmy is given the following apparatus and is instructed to show how the water cycle occurs.

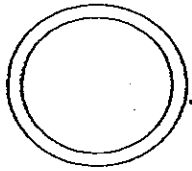

Rubber band

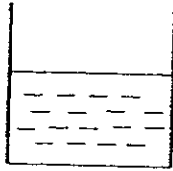

Beaker of water



Plastic sheet

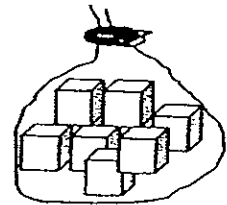

Bag of ice cubes

a. Jimmy is unsure of how to set up the apparatus so that he can demonstrate the water cycle. Using the given apparatus, help Jimmy by drawing the set-up in space below. Label your diagram clearly. (2m)

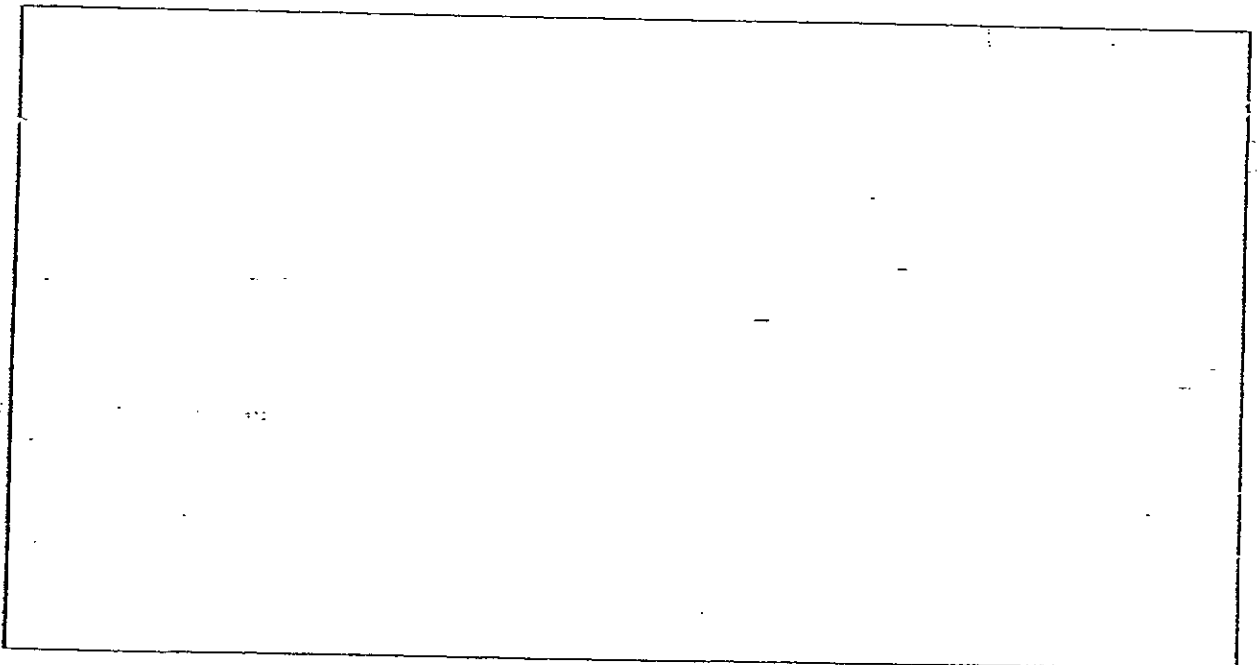

b. Without adding more ice, name one change that can be made to the above setup to speed up the formation of "rain". (1m)

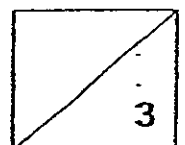

24. Below are the steps to be taken when making an electromagnet. Sequence the steps by numbering them 1 to 4. (2m)

Steps	Order
Coil a wire around the iron nail 20 times.	
Place some thumbtacks near the iron nail.	
Connect the ends of the wire to a battery.	
Take an iron magnet, a piece of long wire and a battery.	

25. Ellen is a young mother with a 3-month old baby. She had pre-prepared milk for her baby and it has turned cold. She then dipped the whole milk bottle into a container of hot water before feeding her baby.

a) Why did Ellen dip the milk bottle in the hot water? (1m)

b) What does the above tell us about heat? (1m)

26. Rita conducted an experiment involving an inverted bottle filled with water in a basin of water as shown below. She blew into the straw continuously for 5 minutes.

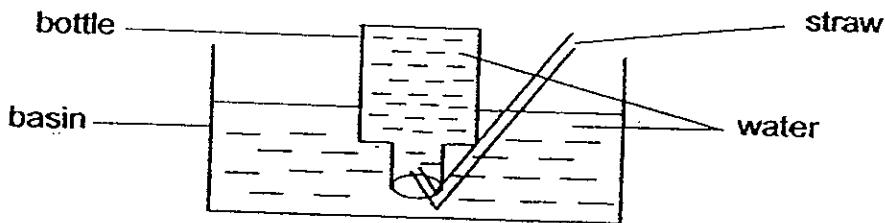

a) What will happen to the water levels in the basin and the bottle? (2m)

b) Explain your answer in part (a). (1m)

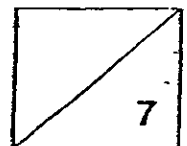

27. Nadra set up the investigation below to compare the heat conductivity of 4 different materials (A, B, C and D).

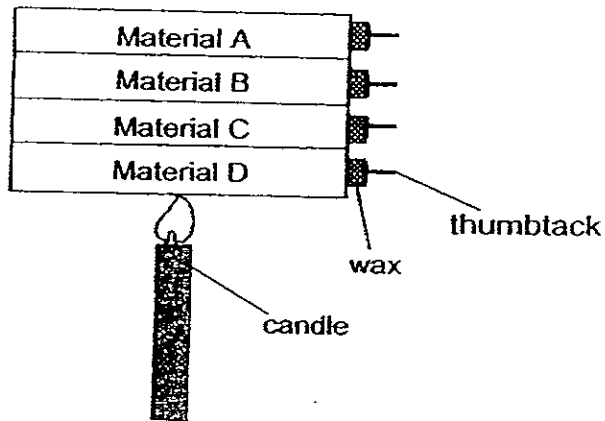

She recorded the results below.

Material	Time taken for the thumbtack to drop (min)
A	8
B	6
C	2
D	4

- a. Is Nadra's investigation a fair one? Explain your answer. (1m)

- b. For the conclusions below, put a tick (✓) in the columns labelled 'True', 'False' or 'Not Possible To Tell'. (2m)

		TRUE	FALSE	NOT POSSIBLE TO TELL
(i)	Material A is a better conductor of heat than Material B.			
(ii)	Material C is a better conductor of heat than Material D.			

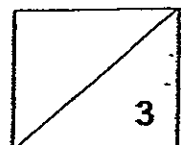

28. Tiffany shone a torch at an object from 2 different directions, A and B as shown below.

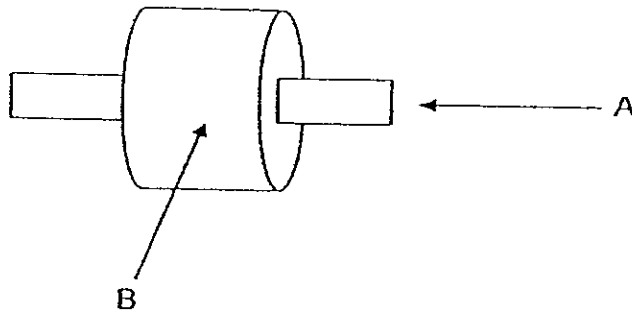

a. Draw the shadows Tiffany saw from direction A in the table below. The shadow Tiffany saw from direction B has been drawn for you. (1m)

Direction the torch was shining from	Shadows Tiffany saw
A	
B	

b. What is the important property of the object above that enables the shadows to be formed? (1m)

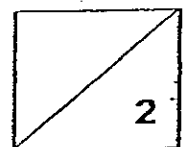

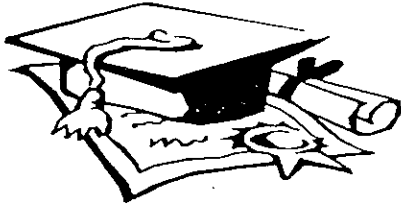

ANSWER SHEET

EXAM PAPER 2008

SCHOOL : SCGS PRIMARY SCHOOL
SUBJECT : PRIMARY 4 SCIENCE

TERM : SA 2

Q1	Q2	Q3	Q4	Q5	Q6	Q7	Q8	Q9	Q10	Q11	Q12	Q13	Q14	Q15	Q16	Q17
1	4	3	2	3	2	3	2	2	3	1	4	4	4	2	2	-3

Q18	Q19	Q20
4	1	4

21)a) Week 1 to 2

b) There were caterpillars on the plant that ate away the leaves.

22)a) A, B

b) Respiration.

23)a)

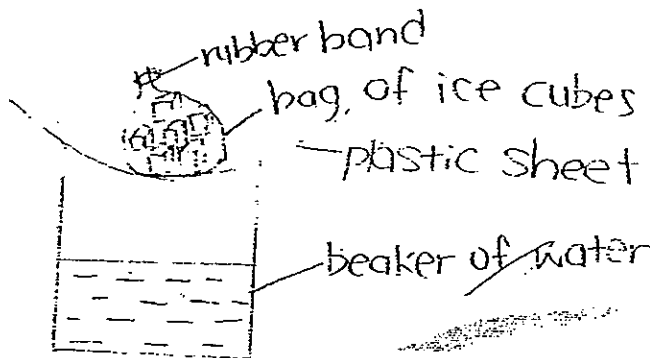

b) Heat up the water.

24)2, 4, 3, 1

25)a)The milk will gain heat from the hot water and turn hot.

b)Heat travels from a hotter place to a cooler place until they reach the same temperature.

26)a)The water level in the basin will rise while the water level in the bottle will fall.

b)Air that Rita blew into the bottle occupies space, forcing some water out of the bottle.

27)a)No, Nadra's investigation is not a fair one materials were stacked on top of one another and they would not have the same amount of heat from the candle.

b)i)Not possible to tell.

ii)True

28)a)

b)The object does not allow light to pass through it.