



**MARIS STELLA HIGH SCHOOL (PRIMARY)**

**SA1 EXAMINATION**

**SCIENCE**

**17 MAY 2021**

**BOOKLET A**

**NAME:** \_\_\_\_\_ (       )

**CLASS:** Primary 4 (       )

24 questions

48 marks

Total Time for Booklets A & B: 1 h 30 min

**DO NOT OPEN THIS BOOKLET UNTIL YOU ARE TOLD TO DO SO.**

**FOLLOW ALL INSTRUCTIONS CAREFULLY.**



For each question from 1 to 24, four options are given. One of them is the correct answer. Make your choice (1, 2, 3 or 4). Shade the correct oval (1, 2, 3 or 4) on the Optical Answer Sheet (OAS). (48 marks)

---

- 1 A snail hides itself in a shell when it is touched.

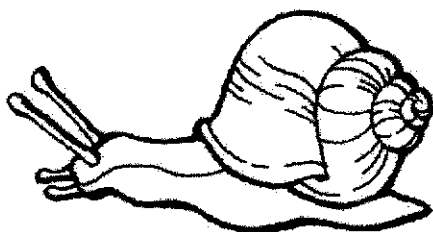

This shows that a snail is a living thing because it \_\_\_\_\_.

- (1) can grow
  - (2) can reproduce
  - (3) responds to changes
  - (4) needs air, food and water
- 2 Which of the following statements are true for all insects?
- A They have wings.
  - B They have six legs.
  - C They have three body parts.
- (1) A and B only
  - (2) A and C only
  - (3) B and C only
  - (4) A, B and C

3 Study the flowchart below.

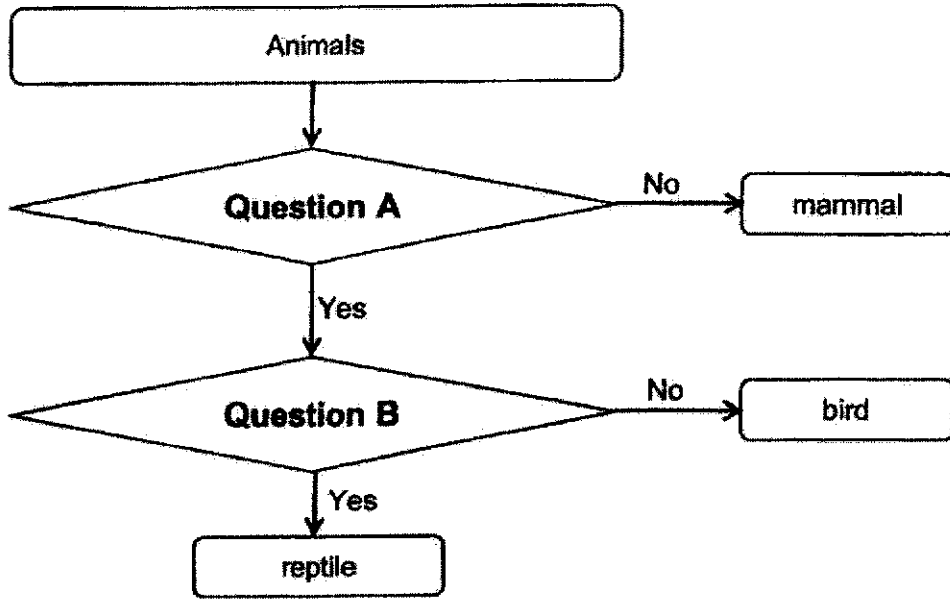

What are questions A and B?

	Question A	Question B
(1)	Does it lay eggs?	Does it have scales as its outer covering?
(2)	Does it give birth to its young?	Does it have scales as its outer covering?
(3)	Does it have feathers as its outer covering?	Does it give birth to its young?
(4)	Does it have hair as its outer covering?	Does it feathers as its outer covering?

- 4 Study the classification chart below.

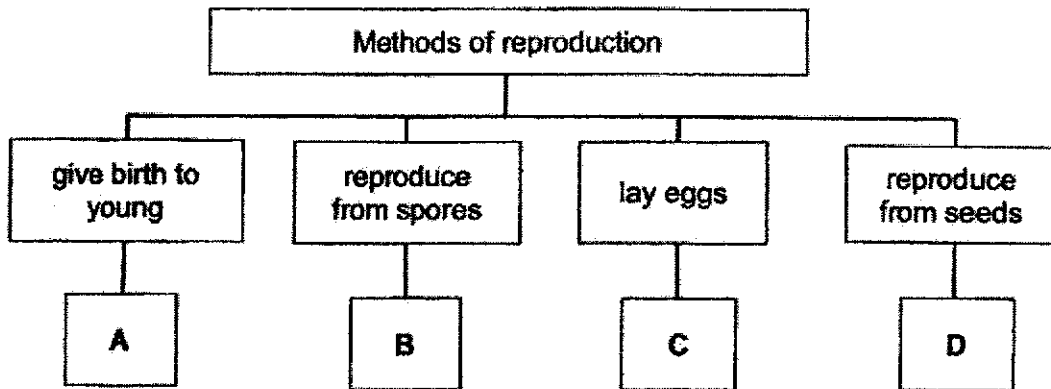

Based on the chart, which of the following is correct?

- (1) A is an amphibian.
  - (2) B is a flowering plant.
  - (3) C is an insect.
  - (4) D is a non-flowering plant.
- 5 The diagram below shows the life cycle of an animal.

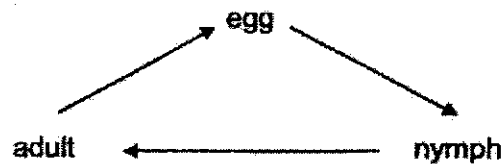

Which of the following animals has the life cycle shown above?

- (1) frog
- (2) beetle
- (3) chicken
- (4) grasshopper

6 Study the classification chart below.

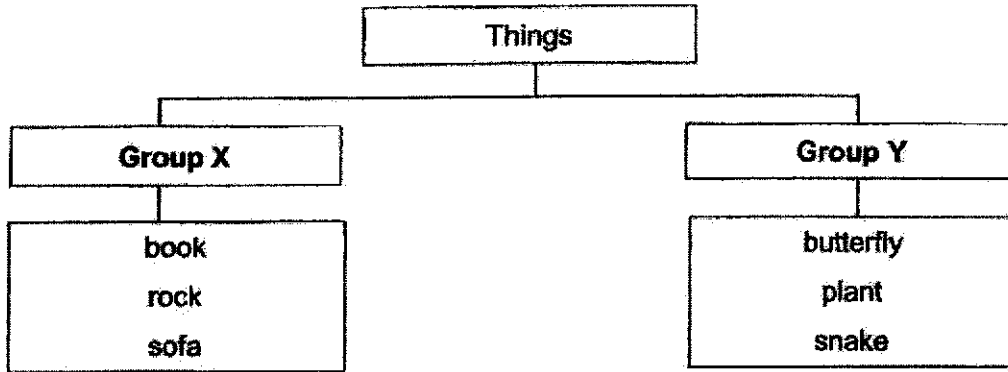

Which of the following can be classified in Group X and Group Y?

	Group X	Group Y
(1)	robot	bird
(2)	bacteria	ant
(3)	tree	mushroom
(4)	water	pencil

7 Jing En was told that placing a dry stalk of celery in water would make it 'fresh' and firm again.

Which of the following ways should he place the dry celery to make it 'fresh' again?

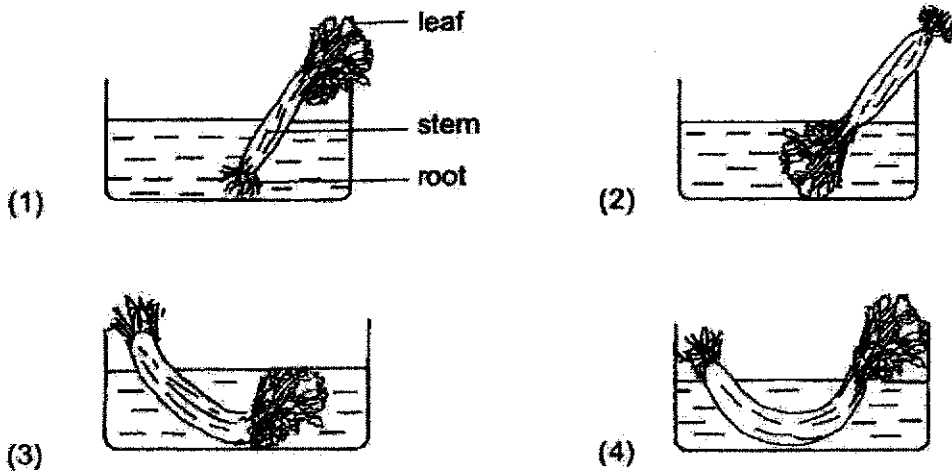

8 The diagram below shows the different stages of the life cycle of a plant.

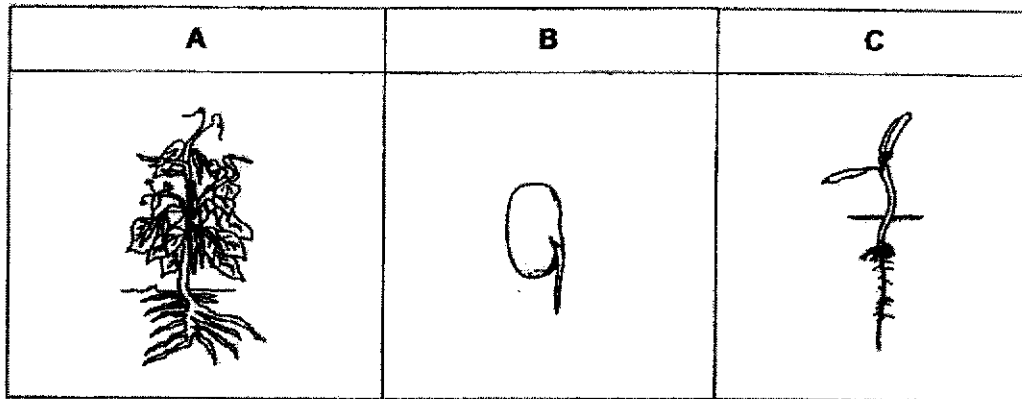

Which of the following shows the correct sequence of the life cycle of the plant?

- (1) A → B → C
- (2) A → C → B
- (3) B → A → C
- (4) C → B → A

9 Study the plant below.

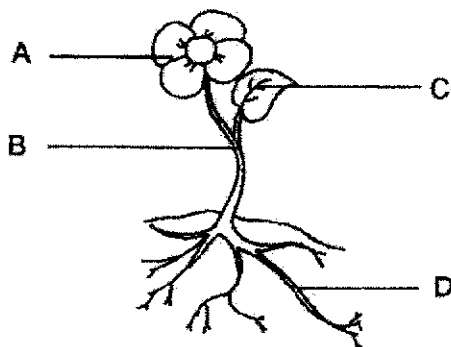

Which part makes food for the plant?

- (1) A
- (2) B
- (3) C
- (4) D

- 10 The table below shows the characteristics of four animals, P, Q, R and S. A tick (✓) represents that the characteristic is present.

Descriptions	Animal			
	P	Q	R	S
The young resembles the adult.	✓		✓	
It has three stages in its life cycle.			✓	✓

Based on the information given, which of the following statements are possible?

- A Animal P is a frog.
- B Animal Q is a beetle.
- C Animal R is a chicken.
- D Animal S is a cockroach.

- (1) A and B only
  - (2) B and C only
  - (3) C and D only
  - (4) A, C and D only
- 11 Which is the function of the human circulatory system?

- (1) To give shape to the body.
- (2) To take in and give out air from the body.
- (3) To help different parts of the body to move.
- (4) To transport food, water and air to all parts of the body.



12 Which body system gives shape to the human body?

(1)

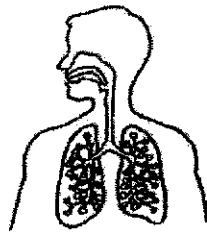

(2)



(3)

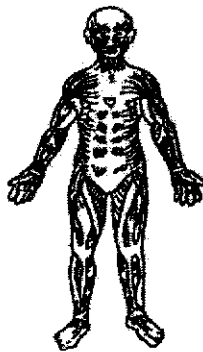

(4)

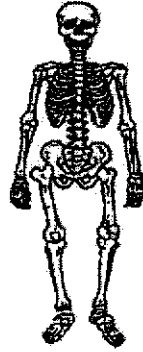

13 The diagram below shows a model of the human digestive system.

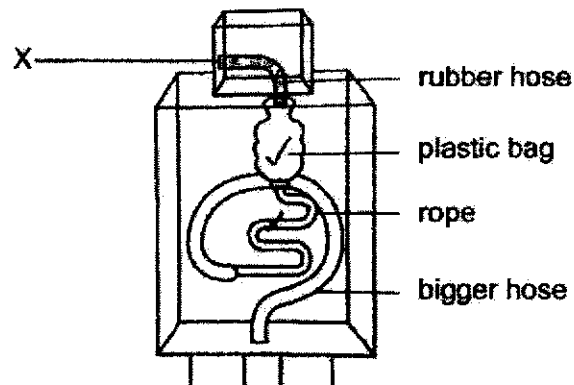

Part X represents the mouth.

Which parts of the model represent where digestive juices are produced?

- (1) rope and plastic bag
- (2) rope and bigger hose
- (3) rubber hose and plastic bag
- (4) rubber hose and bigger hose

- 14 The flowchart below shows the properties of matter P, Q and R.

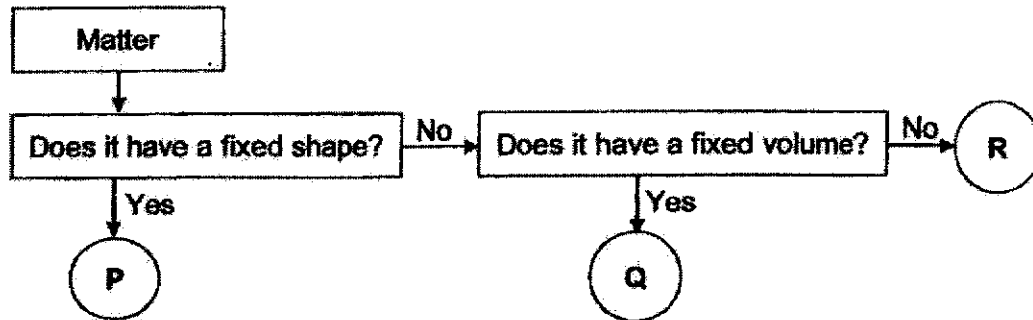

Which of the following represents P, Q and R correctly?

	P	Q	R
(1)	ice	milk	air
(2)	milk	air	ice
(3)	air	ice	milk
(4)	ice	air	milk

- 15 Jane wore a shower cap, as shown below, to keep her hair dry when she showered.

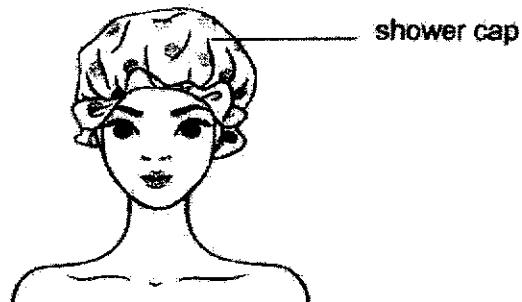

What properties of the shower cap help ensure that Jane's hair is kept dry?

- (1) absorbent and flexible
- (2) waterproof and flexible
- (3) absorbent and transparent
- (4) waterproof and transparent

- 16 The flowchart below shows the properties of materials A, B, C and D.

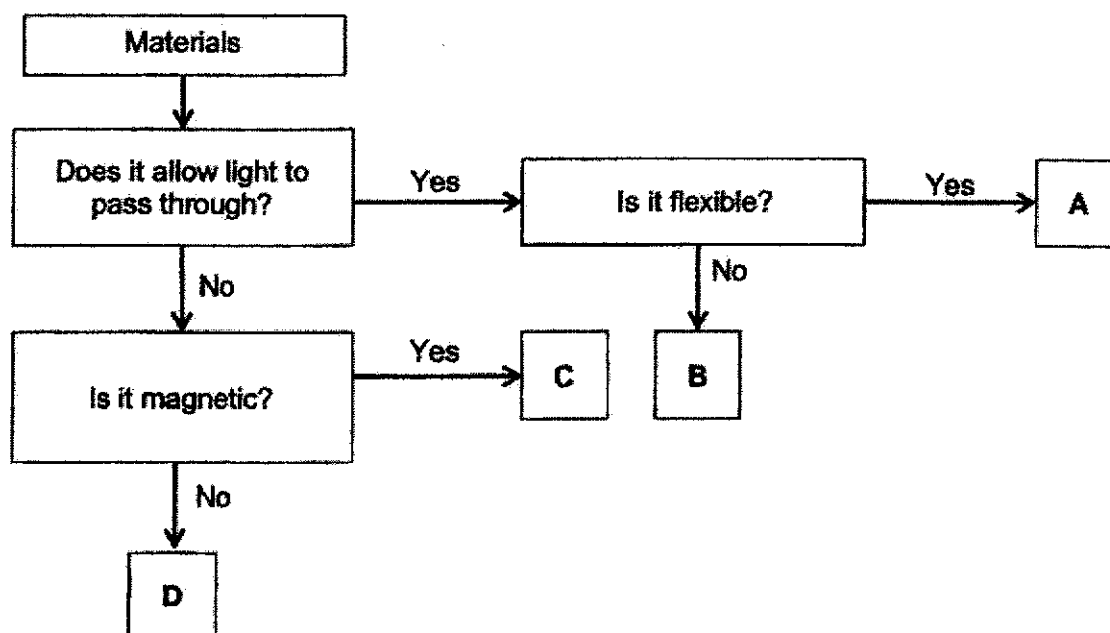

Which of the following can materials A, B, C and D be?

	A	B	C	D
(1)	glass	steel	plastic	copper
(2)	glass	plastic	copper	steel
(3)	plastic	glass	copper	steel
(4)	plastic	glass	steel	copper

- 17 Matter is anything that has mass and occupies space.

Which of the following is not matter?

- (1) air
- (2) water
- (3) pencil
- (4) shadow

- 18 The diagram below shows an air pump and a water tap connected to a tank.

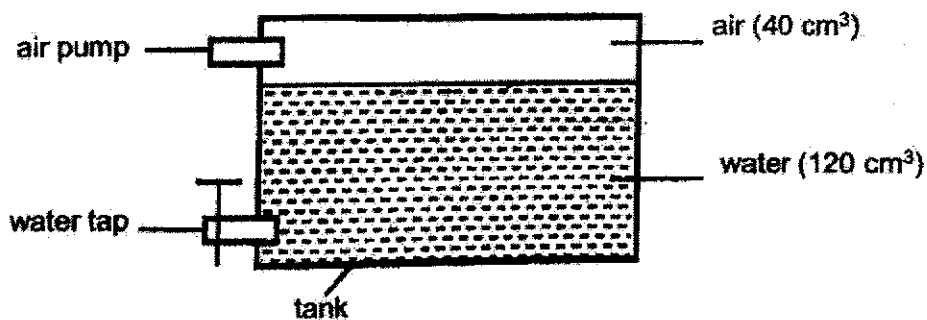

20 cm<sup>3</sup> of water was removed from the tank and 30 cm<sup>3</sup> of air was added into the tank.

What was the final amount of air in the tank?

- (1) 40 cm<sup>3</sup>  
 (2) 60 cm<sup>3</sup>  
 (3) 70 cm<sup>3</sup>  
 (4) 100 cm<sup>3</sup>
- 19 Three materials, A, B and C, were tested for their strength using the set-up shown below. Weights were hung on each material until it broke.

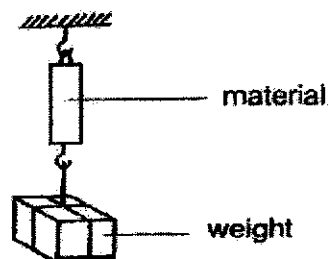

Which of the following must be kept the same for a fair test?

- A type of material  
 B thickness of material  
 C number of weights added to the material
- (1) A only  
 (2) B only  
 (3) A and B only  
 (4) B and C only

- 20 A measuring cylinder is used to measure the volume of an object. The object is first placed into the water. Then the change in the water level is observed.

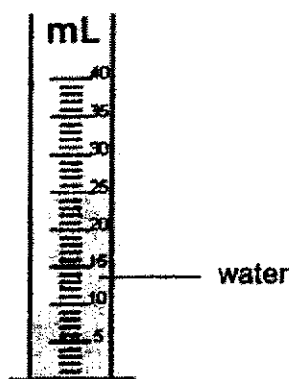

The table below shows the properties of four objects, P, Q, R and S.

Object	Does it allow light to pass through?	Does it float in water?	Is it waterproof?
P	No	Yes	Yes
Q	Yes	No	Yes
R	Yes	Yes	No
S	No	No	No

For which object can we measure its volume using the above method?

- (1) P
- (2) Q
- (3) R
- (4) S

- 21 In the set-up below, A, B, C and D are four rings which pass through a smooth plastic rod. B is a magnet.

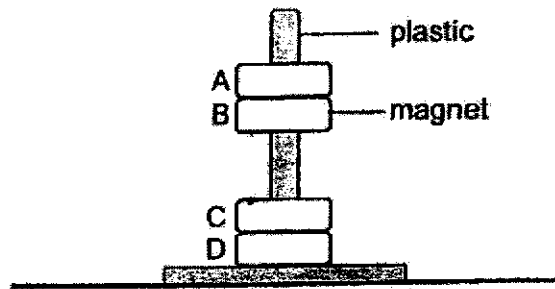

Which one of the following is possible?

	A	C	D
(1)	rubber	steel	steel
(2)	steel	magnet	steel
(3)	magnet	rubber	rubber
(4)	magnet	steel	rubber

- 22 Object A is attracted to a magnet as shown below.

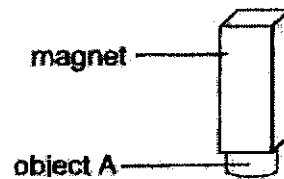

Which materials can object A be made of?

- A iron
- B wood
- C aluminium

- (1) A only
- (2) B only
- (3) C only
- (4) A and C only

23 A compass has a small magnet that can rotate freely as shown.



Four bar magnets are arranged such that they are attracted to one another. A compass was placed near end K and the direction of the compass needle is as shown below.

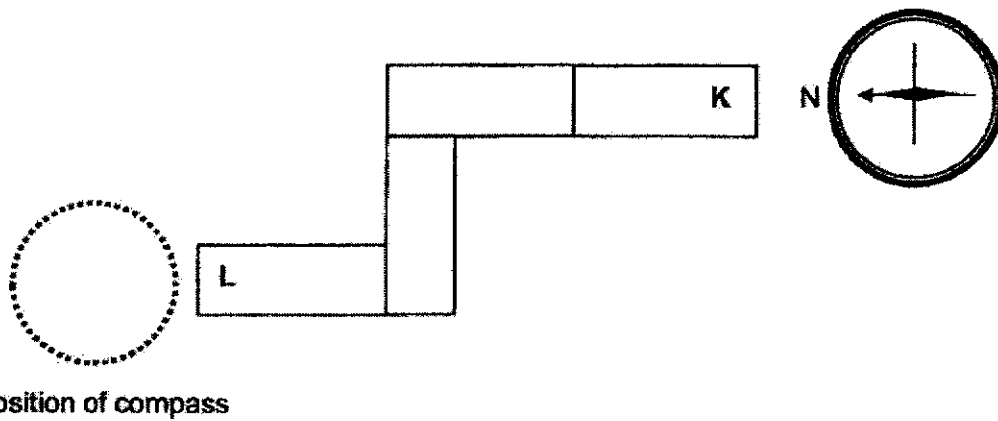

Which of the following would be the direction of the compass needle when the compass was placed at end L?

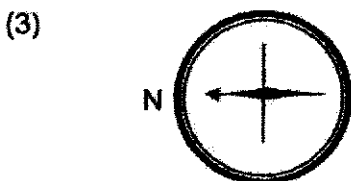
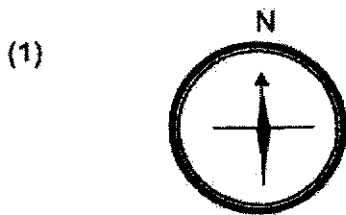

24. Diagram 1 shows a magnet held near rod X which is tied to a string.

A flame was placed under rod X as shown in diagram 2. After a while, rod X moved towards the magnet.

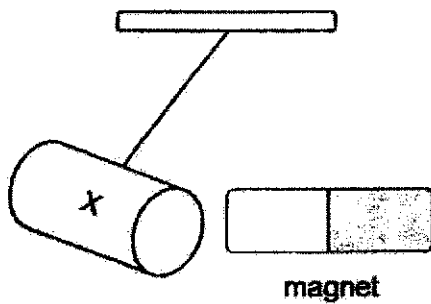

Diagram 1

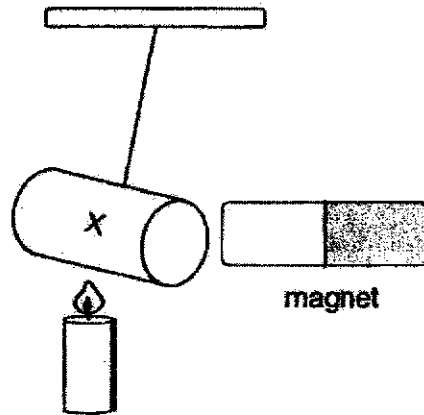

Diagram 2

Which of the following explains why rod X moved towards the magnet after being heated?

- (1) Rod X became heavier.
- (2) Rod X was attracted to the magnet.
- (3) Rod X lost some of its magnetic strength.
- (4) Rod X is made of a non-magnetic material.





**MARIS STELLA HIGH SCHOOL (PRIMARY)**

**SA1 EXAMINATION**

**SCIENCE**

**17 MAY 2021**

**BOOKLET B**

**NAME:** \_\_\_\_\_ (      )

**CLASS:** Primary 4 (      )

10 questions

32 marks

Total Time for Booklets A & B: 1 h 30 min

**DO NOT OPEN THIS BOOKLET UNTIL YOU ARE TOLD TO DO SO.**

**FOLLOW ALL INSTRUCTIONS CAREFULLY.**

**Booklet A:** \_\_\_\_\_ / 48

**Booklet B:** \_\_\_\_\_ / 32

**Grand Total:** \_\_\_\_\_ / 80

**Parent's Signature:** \_\_\_\_\_

For questions 25 to 34, write your answers in this booklet. The number of marks available is shown in brackets [ ] at the end of each question or part question. **(32 marks)**

---

**25** The diagram below shows a plant.

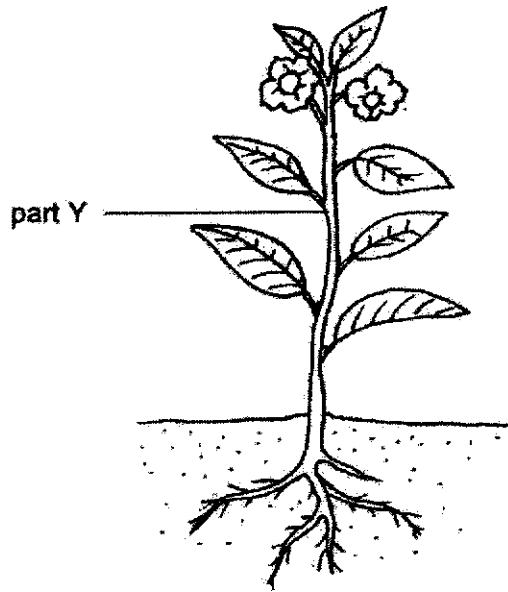

**(a)** Name part Y. [1]

---

**(b)** State one function of part Y. [1]

---

---

	2
--	---

26 Compare animals A and B shown below.

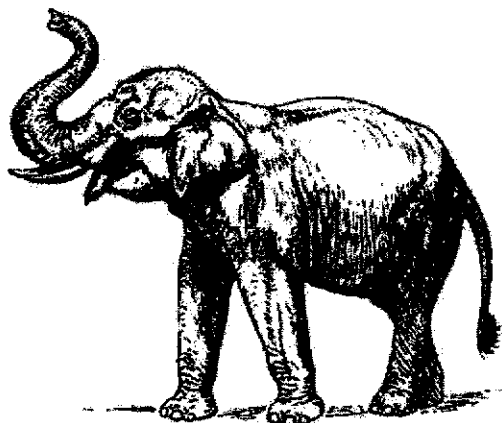

Animal A

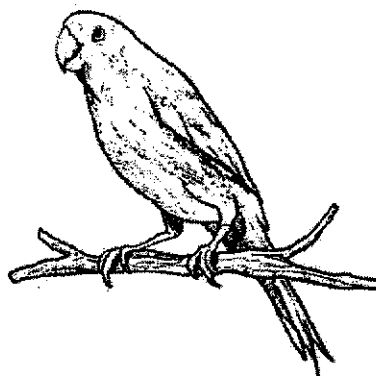

Animal B

(a) Name the animal group that each animal belongs to. [2]

Animal A: \_\_\_\_\_

Animal B: \_\_\_\_\_

(b) State the differences between animal A and animal B in terms of their outer covering and method of reproduction. [2]

(i) Outer covering:

---



---

(ii) Method of reproduction:

---



---



27. The life cycle of insect G is as shown.

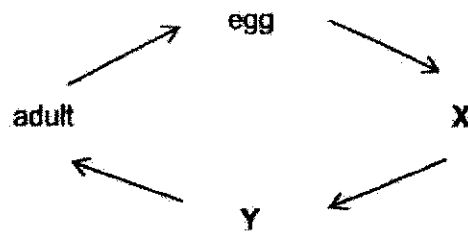

- (a) Identify stages X and Y. [1]

X: \_\_\_\_\_ Y: \_\_\_\_\_

- (b) State one difference between the insect at stages X and Y. [1]

\_\_\_\_\_

- (c) Which of the following animal(s) go through a similar life cycle as insect G? Put a tick (✓) in the correct box(es) below. [1]

mosquito

butterfly

cockroach

	3
--	---

- 28** Victoria kept two adult rabbits in a cage. She recorded the number of rabbits in March and June in the table below. No rabbits were added or removed from the cage during the observation period.

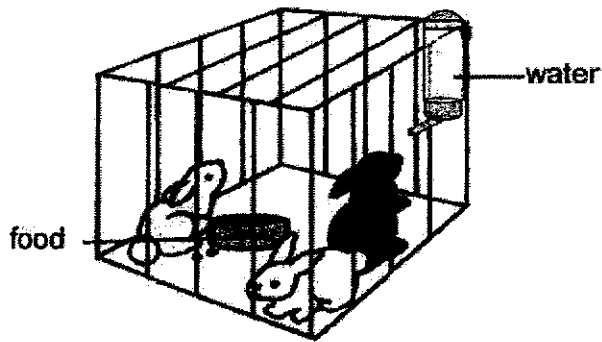

Month	Number of rabbits
March	2
June	8

- (a) List three important conditions the rabbits need to survive. [1]

---



---

- (b) Describe the change in the number of rabbits in the cage from March to June. [1]

---



---

- (c) What characteristic of living things caused the change in the number of rabbits in the cage from March to June? [1]

---



---

	<b>3</b>
--	----------

29 The diagram below shows the human digestive system.

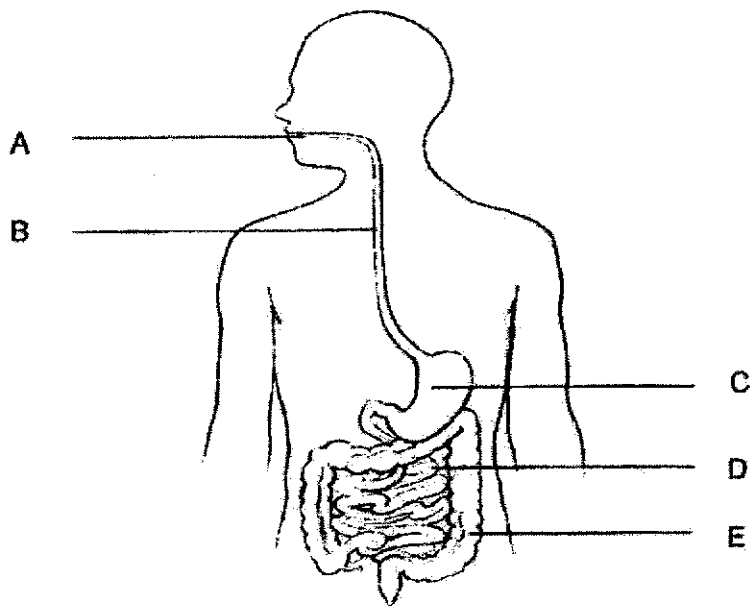

(a) Identify the part where

(i) digestion is completed : \_\_\_\_\_ [½]

(ii) digested food is absorbed into the blood : \_\_\_\_\_ [½]

(b) State the function of A. [1]

---



---



The bar graph below shows the amount of digested food entering different parts of the digestive system.

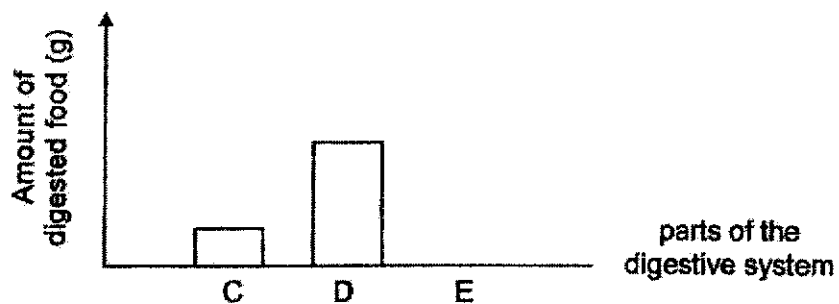

- (c) Explain why no digested food enters E. [1]

---

---

	1
--	---

- 30 Daniel wanted to find out which material, X, Y or Z, is most suitable to make a food tray. He measured the length each material bent when a 500 g weight was hung on it as shown. Each material tested has the same length and thickness.

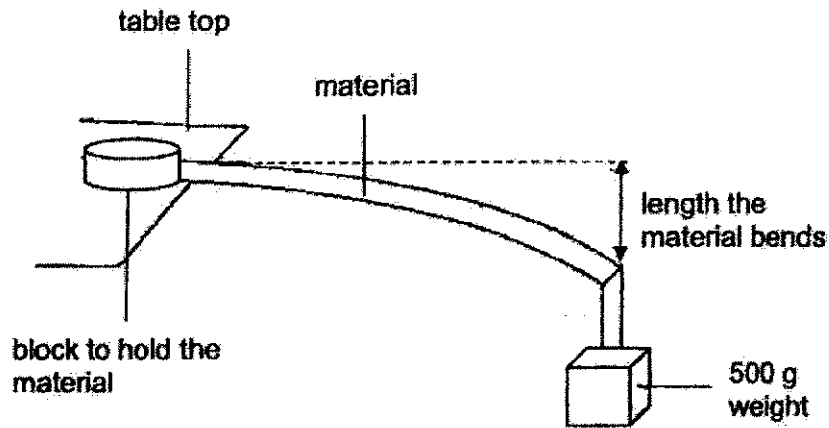

Daniel recorded his results in table below.

Material	Length the material bends (cm)
X	7
Y	0
Z	12

- (a) What property of material is Daniel testing? [1]

---

- (b) Based on his results, which material, X, Y or Z, is most suitable for making the food tray? Give a reason for your answer. [2]



---



---

	3
--	---



- 31 The mass and volume of four solid blocks, A, B, C and D, are measured and recorded in the table below.

Block	Mass (g)	Volume (cm <sup>3</sup> )
A	10	10
B	20	40
C	30	30
D	30	20

Based on the information given, put a tick (✓) in the appropriate boxes below. [3]

	Statement	True	False
(a)	B has the greatest mass.		
(b)	C occupies more space than A.		
(c)	The larger the size of the block, the greater the mass of the block.		

	3
--	---

- 32(a) Erica conducted an experiment to investigate how the number of batteries affects the magnetism of an electromagnet using the set-ups below.

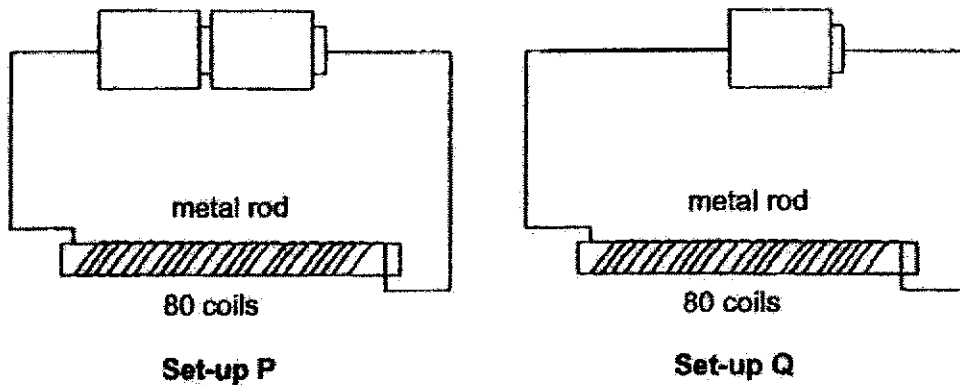

She recorded the number of paper clips attracted by the electromagnets of set-ups P and Q in the table below.

- (i) Complete the table below by filling in letters P and Q. [1]

Set-up	Number of paper clips attracted
	10
	25

- (ii) Explain your answer for set-up P in (i). [1]

---



---

	2
--	---

- (b) Erica wanted to find out if the number of coils of wire affects the magnetic strength of the electromagnet. The diagram below show her set-ups.

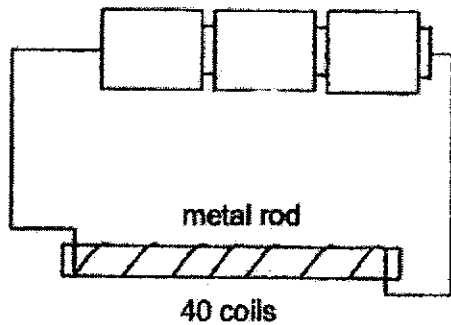

Set-up R

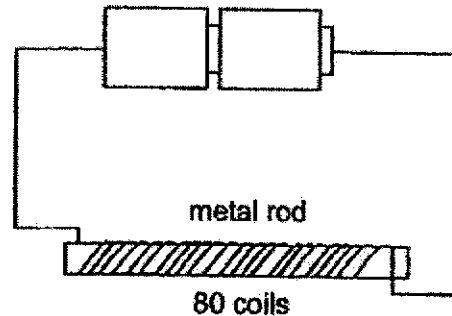

Set-up S

Erica's teacher told her that her experiment is not fair.

Suggest one change to set-up R to make her experiment fair:

[1]

---



---



- 33 Lara stroked a nail with a magnet as shown. The nail became a magnet and was used to attract paper clips.

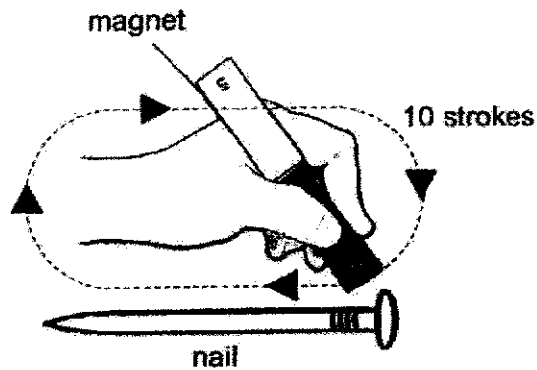

- (a) Using the same magnet, suggest one way to increase the number of paper clips the nail can attract. [1]

---

Lara observed that the magnetised nail was able to attract a paper clip through a plastic sheet as shown in the diagram below.

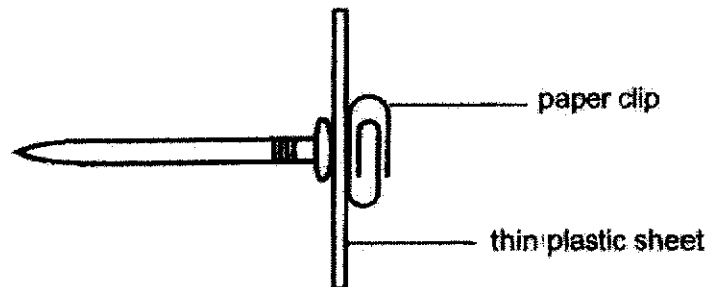

- (b) Based on Lara's observation, she concluded that a magnet can attract magnetic materials like the paper clip.

State another conclusion that Lara can make based on her observation. [1]

---



---



Lara placed one end of the magnetised nail, one at a time, near objects H and K as shown.

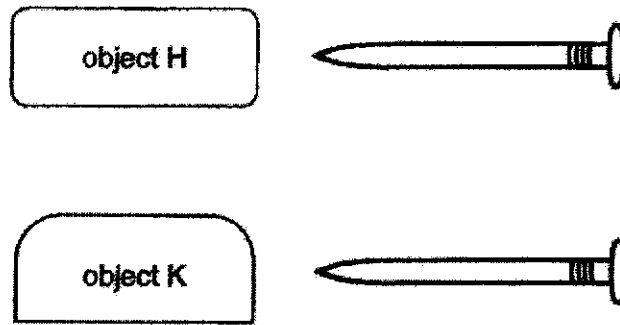

She observed that H moved away from the nail but K did not move at all.

(c) She concluded that object H is a magnet.

Do you agree? Give a reason.

[1]

---

---

(d) She concluded that object K is made of a magnetic material.

Do you agree? Give a reason.

[1]

---

---



34 A syringe laid on a table is filled with substances X and W as shown in Diagram 1.

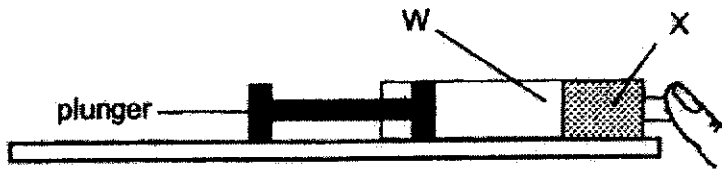

Diagram 1

When the plunger is pushed, it moved towards the finger as shown in Diagram 2.



Diagram 2

(a) What is the state of substance W? [1]

\_\_\_\_\_

(b) State two properties of substance X. [2]

\_\_\_\_\_  
\_\_\_\_\_

A bicycle tyre contains 4000 cm<sup>3</sup> of air when fully inflated. When 500 cm<sup>3</sup> of air was pumped in, the fully inflated tyre did not burst.

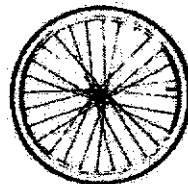

(c) What property of air allowed the tyre not to burst? [1]

\_\_\_\_\_

End of Paper

	4
--	---

SCHOOL : MARIS STELLAR HIGH SCHOOL  
 LEVEL : PRIMARY 4  
 SUBJECT : SCIENCE  
 TERM : SA 1

Q1	Q2	Q3	Q4	Q5	Q6	Q7	Q8	Q9	Q10
3	3	1	3	4	1	1	1	3	2
Q11	Q12	Q13	Q14	Q15	Q16	Q17	Q18	Q19	Q20
4	4	1	1	2	4	4	2	2	2
Q21	Q22	Q23	Q24						
2	1	3	3						

Q25	<p>a) Stem</p> <p>b) <u>Keeps/ holds the plant upright/ supports the plant</u></p>
Q26	<p>a) Animal A: Mammal Animal B: Bird</p> <p>b) Outer covering: A has hair/fur but B has feathers</p> <p>Method of Reproduction: A give birth but B lays eggs.</p>
Q27A	<p>a) X: Larva/ Larval Y: Pupa / Pupal</p> <p>b) Insect at Y does not feed / eat / move but it does at stage X</p> <p><input checked="" type="checkbox"/> mosquito      <input checked="" type="checkbox"/> butterfly      cockroach</p> <p>c)</p>
Q28	<p>a) Rabbits need <b>air, food and water</b></p> <p>b) The number of rabbits <b>increased</b>.</p> <p>c) <b>Living things reproduce</b></p>
Q29	<p>a) i) D ii) D</p> <p>b) It chews/breaks down food into smaller pieces. Digest food (into simpler substances) / Break down food (into simple substances)</p> <p>c) All the digested food has been absorbed into the bloodstream at the organ C/ small intestine.</p>
Q30	<p>a) Length the material bends <b>without breaking</b> / how much the material bends <b>without breaking</b> / flexibility of the material.</p> <p>b) Material Y. It is not flexible. / It does not bend. / It it's the stiffest.</p>

Q31	Statement	True	False
	i) B has the greatest mass		✓
	ii) C occupies more space than A	✓	
	iii) The large the size of the block, the greater the mass of the block		✓
Q32	a) <ul style="list-style-type: none"> <li>i) Q: 10 P: 25</li> <li>ii) As the number of batteries increases, the number of paper clips attracted by the electromagnet increases. / As the number of batteries decreases, the number of paper clips attracted by the electromagnet decreases. / Setup Q had an extra battery which made its magnetism stronger.</li> <li>b) Remove 1 battery. / Have (only) 2 batteries in.</li> </ul>		
Q33	a) Stroke the nail more times. b) Magnetism strength/ magnetism can pass through the thin plastic sheet, which is a non-magnetic material. c) <u>Yes</u> . Only magnets / like poles can repel each other d) No. Object K was <b>not attracted by</b> the magnetized nail, it is non-magnetic		
Q34	a) Gas/ Gaseous state b) X cannot be compressed/definite volume X has a fixed shape  c) Air can be compressed / does not have a definite volume.		