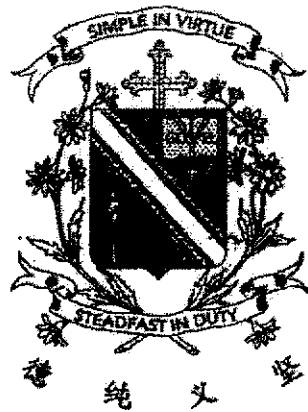

Name: _____ ()

Class: Primary 4 _____

CHIJ ST NICHOLAS GIRLS' SCHOOL

Primary 4
Mid-Year Assessment
SCIENCE
BOOKLET A
11 May 2021

Total Time for Booklets A and B: 1 hour 45 minutes

28 questions
56 marks

Do not open this booklet until you are told to do so.
Follow all instructions carefully.
Answer all questions.

This booklet consists of 18 printed pages.

Section A (28 x 2 marks = 56 marks)

For each question from 1 to 28, four options are given. One of them is the correct answer. Make your choice (1, 2, 3 or 4). Shade the correct oval (1, 2, 3 or 4) on the Optical Answer Sheet provided.

1. Katherine placed a dish of sugar cubes beside some ants as shown below.

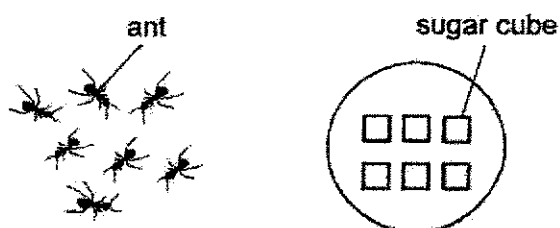

She observed that the ants moved towards the dish of sugar cubes. Which characteristics of living things explains her observation?

- (1) Living things can die.
- (2) Living things can grow.
- (3) Living things can reproduce.
- (4) Living things need food to stay alive.

2. Study the classification chart below.

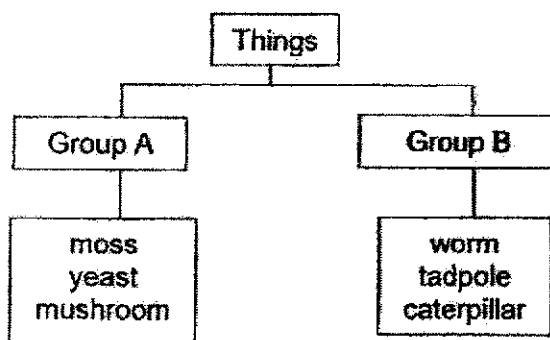

Which of the following best represents groups A and B?

	Group A	Group B
(1)	fungi	animal
(2)	can make its own food	cannot make its own food
(3)	can reproduce	cannot reproduce
(4)	cannot move from place to place	can move from place to place

3. The diagram below show a lily plant and a fern.



lily plant



fern

Which of the following statement(s) is/are true?

- A The fern is a fungi.
- B The lily plant reproduces by seeds.
- C Only the lily plant is able to make food.
- D The fern cannot move from place to place.

- (1) A only
- (2) A and C only
- (3) B and D only
- (4) B, C and D only

4. Which of the following statements are true about bacteria?

- A All bacteria are harmful to us.
- B Some bacteria are not microorganisms.
- C Bacteria feed on living things, dead or alive.
- D Bacteria comes in different shapes and sizes.

- (1) A and D only
- (2) B and C only
- (3) C and D only
- (4) A, B and C only

5. Siti conducted an experiment to find out if the surrounding temperature affects the growth of mushrooms. She placed four set-ups W, X, Y and Z in different locations and watered them daily. She observed their growth for two weeks and recorded the results in the table below.

Set-up	Height of mushroom (cm)		Amount of water given daily (ml)	Surrounding temperature (°C)
	Start of the experiment	End of the experiment		
W	3	4	10	3
X	3	9	10	15
Y	5	14	10	27
Z	5	7	10	40

Based on the table, which of the following statement(s) is/are correct?

- A The least suitable temperature to grow the mushrooms is 15°C.
- B The most suitable temperature to grow the mushrooms is 27°C.
- C The amount of water added affected the growth of the mushrooms.

- (1) A only
- (2) B only
- (3) A and C only
- (4) B and C only

6. Paul conducted an experiment shown below.

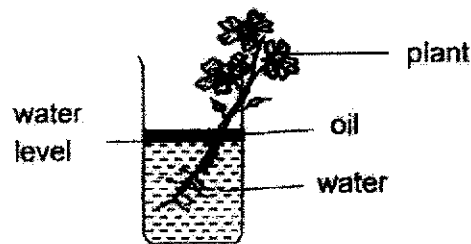

He recorded the water level over a few days in the graph below.

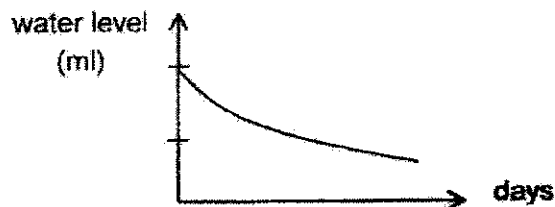

Based on the results, what can he conclude from his experiment?

- (1) The plant has grown taller.
 - (2) The plant needs air to stay alive.
 - (3) The plant took in water through the roots.
 - (4) The plant will die if its roots are removed.
7. Germaine wanted to find out if the amount of water given to the seeds would affect the germination of seeds.

Set-up	Number of seeds	Amount of water given daily (ml)	Presence of light
A	10	100	No
B	12	50	Yes
C	10	50	No
D	12	100	No

Which two set-ups should she choose to conduct a fair test?

- (1) A and C only
- (2) A and D only
- (3) B and C only
- (4) B and D only

8. Lisa observed some organisms P, Q, R and S shown below.

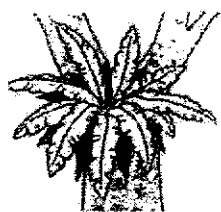

organism P

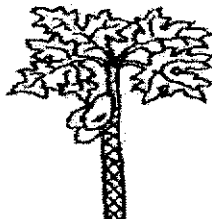

organism Q



organism R



organism S

Which organism(s) is/are not able to undergo the following life cycle?

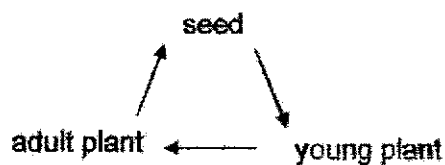

- (1) Q only
- (2) S only
- (3) P and R only
- (4) P, R and S only

9. Which of the following characteristic(s) would most likely be found in the beetle at its larval stage?

- A It eats a lot.
- B It develops wings.
- C It moults several times.
- D It can reproduce at this stage.

- (1) A and C only
- (2) B and D only
- (3) A, B and C only
- (4) B, C and D only

10. The diagram below shows a duck and a frog.

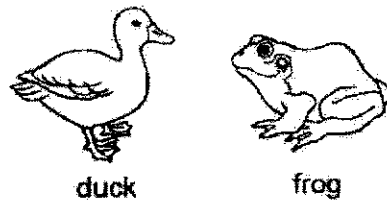

Which of the following shows the correct similarity and difference for the two animals?

	Similarity	Difference
(1)	Both can fly.	The duck has a beak but the frog does not.
(2)	Both lay eggs.	The duck lives in water but the frog lives only on land.
(3)	Both have feathers.	The duck has two legs but the frog has four legs.
(4)	Both have webbed feet.	The duck has wings but the frog does not.

11. Study the classification chart below.

Group X	Group Y

Which of the following are suitable headings for group X and Y?

	Group X	Group Y
(1)	do not have shells	have shells
(2)	covered with scales	covered with scaly skin
(3)	have tails	do not have tails
(4)	lay eggs	give birth to young alive

12. The graph below shows the number of days in each stage of the life cycle of animals W and X.

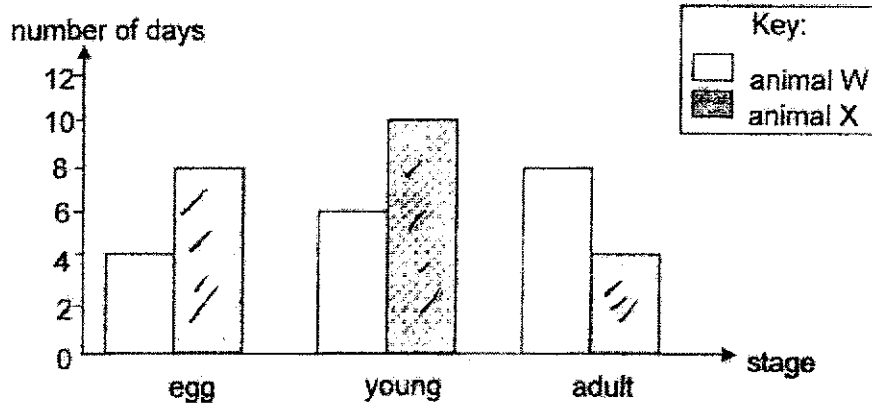

Based on the graph, which of the following statements is correct?

- (1) Animal W lays more eggs than animal X.
 - (2) Animal W takes 14 days to become an adult after the egg hatches.
 - (3) Animal X takes a shorter time than animal W to complete its life cycle.
 - (4) Animal X and W do not have the same number of stages in their life cycles.
13. P, Q, R, S, T are organs in the digestive system. The graph below shows the amount of undigested food leaving each organ after a meal.



Which of the following is correct?

	Mouth	Gullet	Small Intestine	Large Intestine
(1)	P	Q	R	T
(2)	S	P	T	R
(3)	S	R	P	Q
(4)	P	S	Q	R

14. The diagram below shows the human skeletal system.

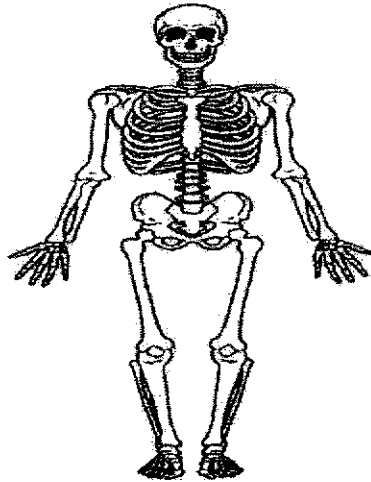

Which of the following statements correctly describe the functions of the human skeletal system?

- A It supports the body.
- B It gives the body shape.
- C It protects the organs in the body.
- D It enables different parts of the body to move.

- (1) A and D only
- (2) B and C only
- (3) A, B and C only
- (4) B, C and D only

15. Ashley poured a packet of coffee into a cup as shown below.

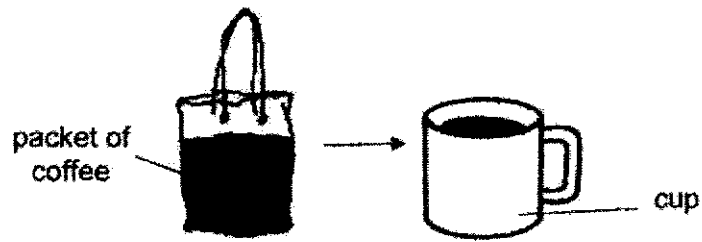

Which of the following statements best describes the property of the coffee?

- A It can be compressed.
- B It does not have a fixed shape.
- C It does not have a fixed volume.

- (1) B only
- (2) C only
- (3) A and B only
- (4) A and C only

16. Study the flow chart below.

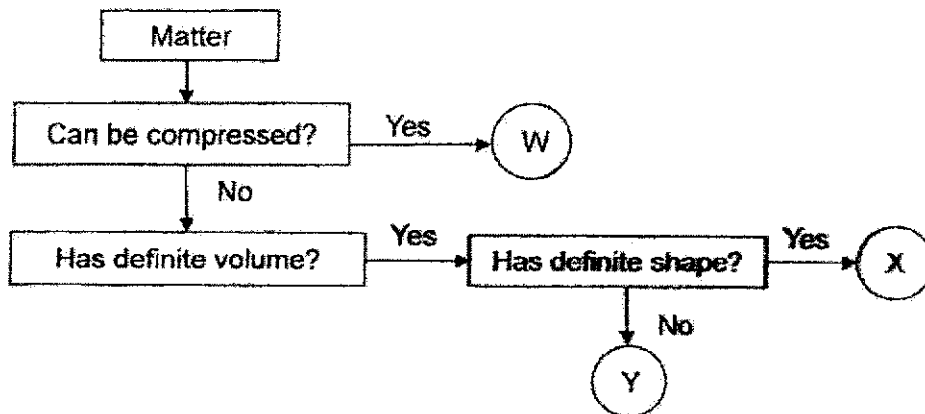

Which of the following best represents the letters W, X and Y?

	W	X	Y
(1)	air	ruler	milk
(2)	ruler	milk	air
(3)	air	water	eraser
(4)	water	eraser	ruler

17. Fatimah conducted an experiment using two similar cups W and X. She pasted a piece of dry tissue in each cup at the same position. She then made a hole in cup X. Next, she pushed both cups into two similar basins of water as shown below.

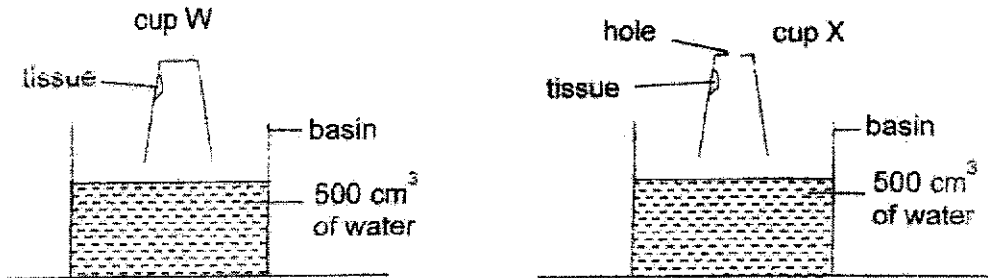

Fatimah made some observations.
Which of the following statements are true?

- A Only the tissue in cup X became wet.
 - B More water entered cup W than cup X.
 - C The tissue in both cups became wet.
 - D Air in cup W takes up space so water level in cup W is lower than in cup X.
- (1) A and B only
 (2) A and D only
 (3) B and C only
 (4) C and D only

18. The diagram below shows a syringe attached to a tank.

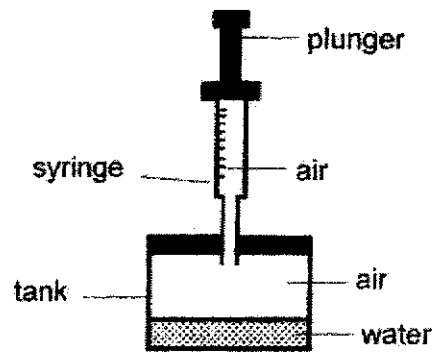

Which of the following observations is correct after the plunger is pushed in?

	volume of air in the tank	volume of water in the tank	total volume of air and water in the tank
(1)	increased	remained the same	increased
(2)	increased	decreased	increased
(3)	remained the same	remained the same	remained the same
(4)	remained the same	decreased	increased

19. The diagram below shows four identical magnets hanging freely on a bar. A, B, C, D, E, F, G and H are poles of the magnets.

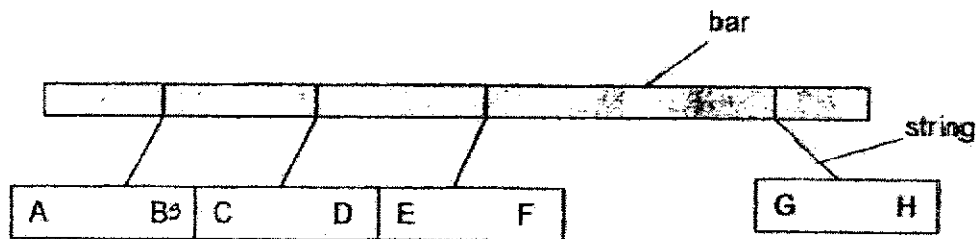

Which one of the following statements is true about the magnets shown above?

- (1) B will repel E.
- (2) F and H are like poles.
- (3) A and D are like poles.
- (4) C will be attracted to G.

20. Sheila conducted an experiment by suspending three identical magnets using similar rubber bands E, F and G. She then placed objects P, Q and R below the magnets as shown in the diagram below.

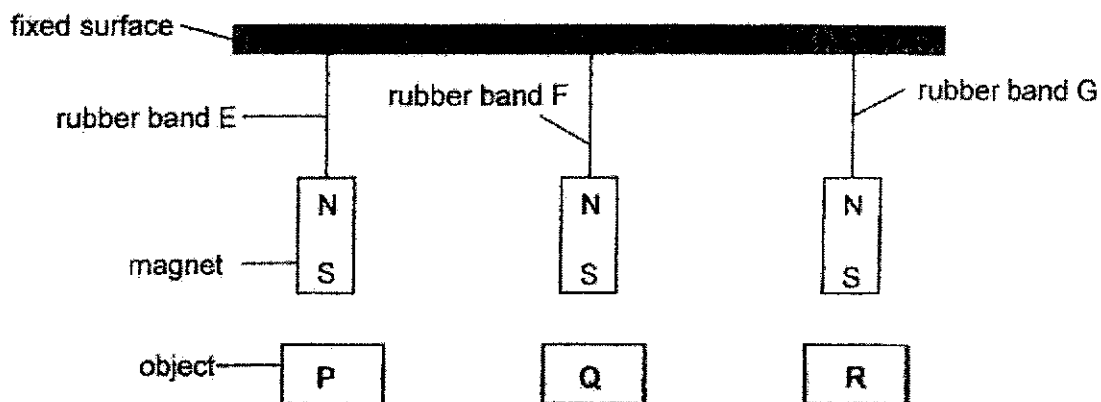

She recorded the lengths of the rubber bands in the table below.

Rubber band	Length of the rubber band (cm)	
	Before experiment	After experiment
E	4	2
F	4	4
G	4	6

Based on the table above, which of the following statements is true?

- (1) Object R repels the magnet.
- (2) Object P attracts the magnet.
- (3) Object Q is made of a non-magnetic material.
- (4) Object P is made of a non-magnetic material.

21. Joanna hung a magnet from a fixed support. Using a string, she tied a paper clip to the table. The paper clip remained in an upright position in the air. She placed different materials of the same thickness between the magnet and paper clip as shown below.

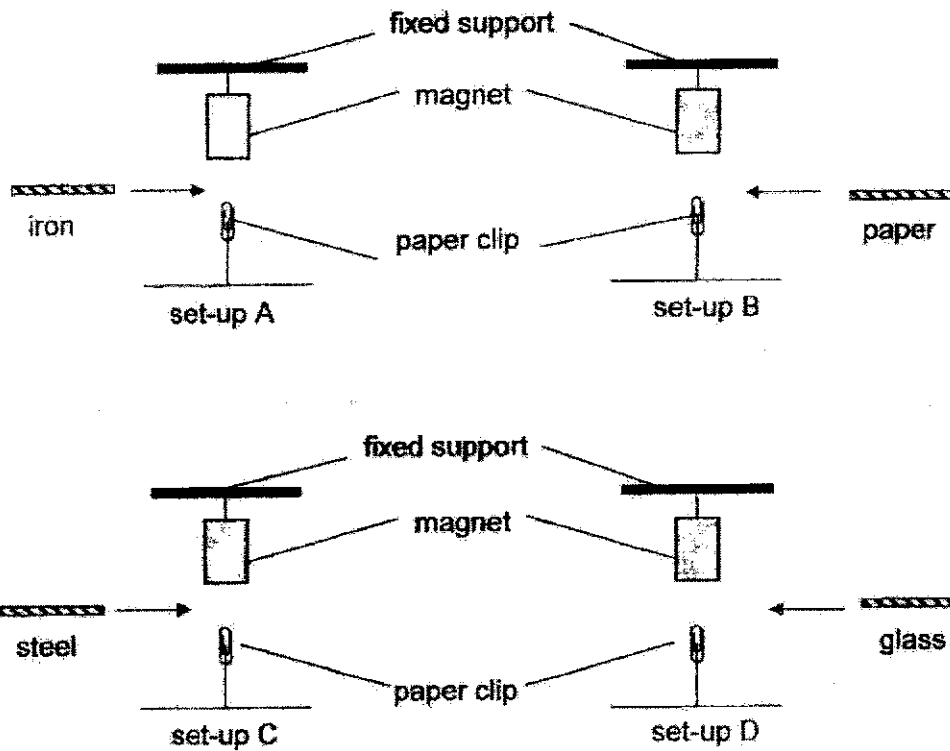

In which set-ups A, B, C or D will the position of the paper clips remain unchanged after the materials were placed in between the magnet and the paper clip?

- (1) A and C
- (2) A and D
- (3) B and C
- (4) B and D

22. Wayne had a bar magnet and a rod magnet. He placed the bar magnet at one end of a ruler and slowly moved a paper clip towards it until the paper clip was attracted to the magnet. He repeated the experiment with the rod magnet.

before

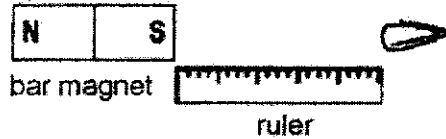

after

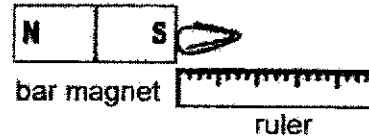

before

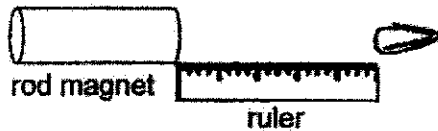

after



What can Wayne do to find out which magnet has a greater magnetic strength?

- (1) He should measure the length of the magnets.
 - (2) He should measure the distance between the ruler and the paper clip.
 - (3) He should measure the distance at which the paper clip is attracted to the magnet.
 - (4) He should measure the distance between the magnet and the paper clip at the start of the experiment.
23. Study the diagram below.

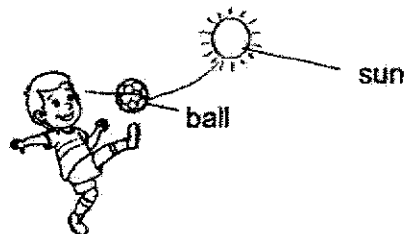

Which of the following statements explains how the boy can see the ball?

- (1) The ball is a source of light.
- (2) The boy's eyes reflected light from the sun onto the ball.
- (3) The ball reflected light from the sun into the boy's eyes.
- (4) The sunlight can pass through the ball into the boy's eyes.

24. Ming Han used a torch and shone at the object from different directions in a dark room.

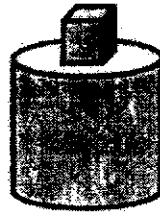

Which of the following are possible shadows formed by the object?

(A)



(B)

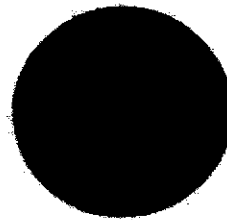

(C)

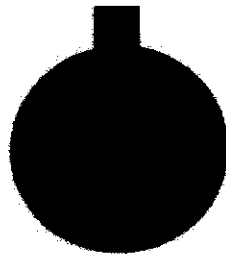

(D)



- (1) A and B only
 (2) B and C only
 (3) C and D only
 (4) A, C and D only

25. Study the diagram below.

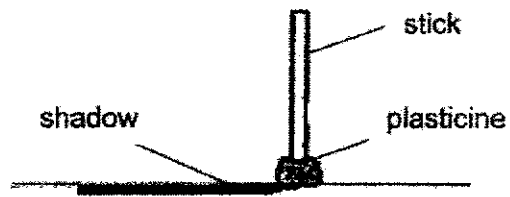

At which position should Mariam shine the torch so that it forms the shadow shown above?

(1)

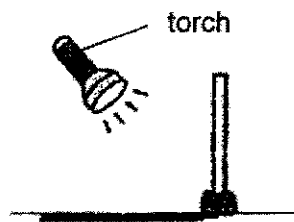

(2)

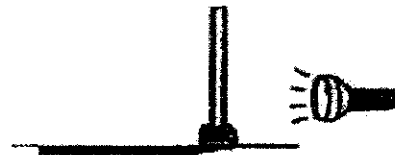

(3)



(4)

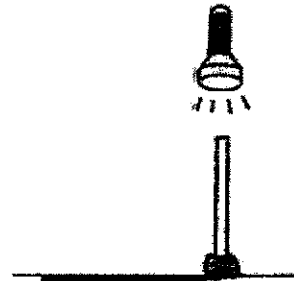

26. Eric wanted to find out how the distance between the torch and the object affected the size of the shadow.

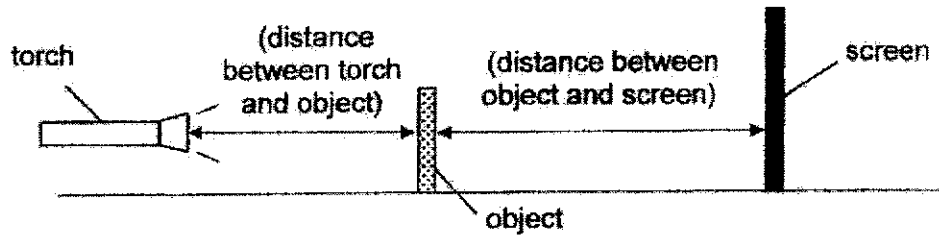

Which of the following variables should be kept constant to ensure a fair test?

- A The object used in the experiment
 - B The amount of light from the torch
 - C The distance between the torch and the screen
 - D The distance between the torch and the object
- (1) A and B only
 (2) C and D only
 (3) A, B and C only
 (4) A, C and D only

27. The picture below shows a window in Diana's house. She noticed that different materials were used to make the different parts of her window.

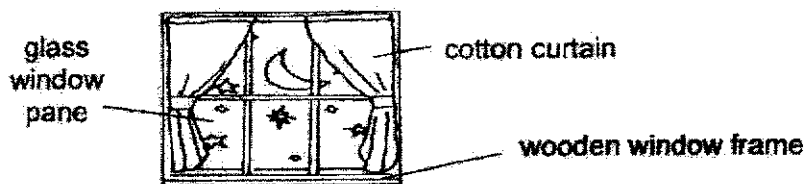

Which of the following best describes the properties of the materials used to make the different parts of her window?

	Wood	Cotton	Glass
(1)	waterproof	flexible	sinks in water
(2)	sinks in water	light	strong
(3)	not flexible	floats on water	allows light to pass through
(4)	strong	does not allow light to pass through	waterproof

28. Ravi carried out an experiment using four similar-sized fishing lines made of different materials A, B, C and D. He hung some weights at the end of each fishing line until the line broke. He recorded his results in the table below.

Material	Number of 2-kg weights it can hold before breaking
A	30
B	7
C	10
D	21

Which of the following statements are true?

- A Material A is the strongest material.
- B Material D is heavier than material C.
- C Material D is stronger than material B.
- D Material A is more flexible than material C.

- (1) A and C
- (2) A and D
- (3) B and C
- (4) C and D

END OF BOOKLET A

Name : _____ ()

Class : Primary 4 _____

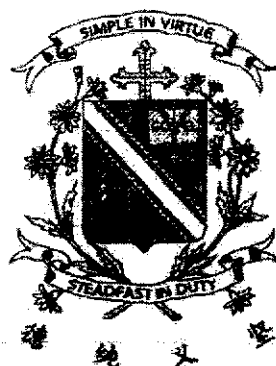
CHIJ ST NICHOLAS GIRLS' SCHOOL**Primary 4****Mid-Year Assessment****SCIENCE****BOOKLET B****11 May 2021****Total Time for Booklets A and B: 1 hour 45 minutes****13 questions
44 marks****Do not open this booklet until you are told to do so.
Follow all instructions carefully.
Answer all questions.****This booklet consists of 14 printed pages.**

Booklet A	56
Booklet B	44
Total	100

Parent's Signature/Date

Section B (44 marks)

For questions 29 to 41, write your answers in this booklet. The number of marks available is shown in the brackets at the end of each question or part question.

29. The diagram below shows the human digestive system.

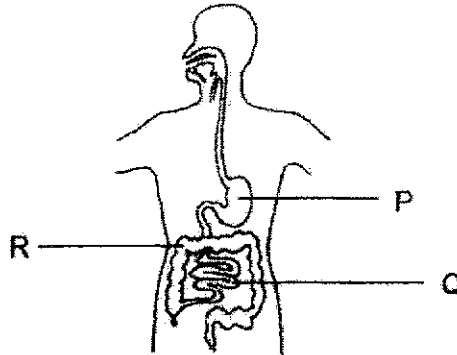

(a) The digestive system produces digestive juices. What is the function of the digestive juices? [1]

(b) State one difference between the function of Part P and Part Q of the digestive system. [1]

(c) What would happen to the undigested food if Part R of the digestive system is not functioning well? [1]

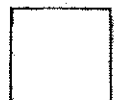

30. In a brightly lit room, Ming Jun placed two similar bell jars made of clear glass over two similar plants A and B. He covered the bell jar in set-up X with black paper. He watered both plants with the same amount of water daily.

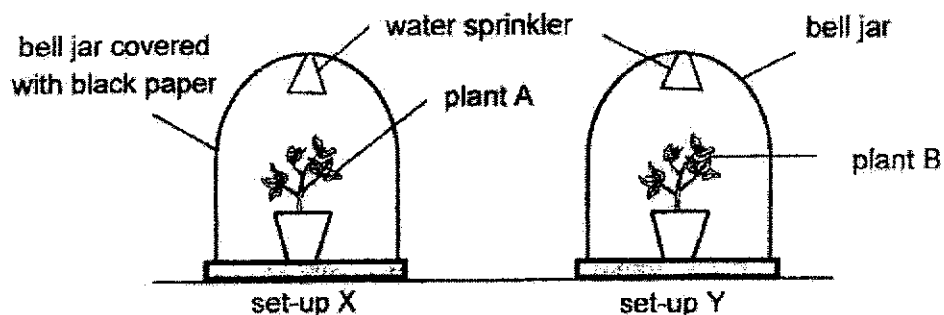

After a week, Ming Jun observed that the plant in one of the set-ups had died but the other plant remained healthy.

- (a) What is the aim of Ming Jun's experiment? [1]

- (b) Which plant died? Give a reason for your answer. [2]

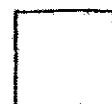

31. Zi Qi placed four similar tomatoes A, B, C and D in four different locations as shown below. A tick (✓) indicates the presence of the condition.

	Conditions		
	Warm	Moist	Dark
Location W		✓	✓
Location X	✓		✓
Location Y	✓	✓	
Location Z	✓		

She observed the tomatoes after two weeks and recorded the amount of grey patches that grew on the tomatoes. Her results are shown in the graph below.

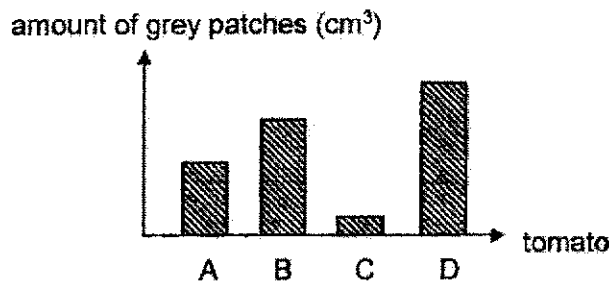

- (a) What were the grey patches that were observed growing on the tomatoes? [1]

- (b) Based on the results shown above, which location W, X, Y or Z was tomato D placed in? Explain your answer. [1]

- (c) Suggest a method of keeping tomatoes fresh for a longer period of time. [1]

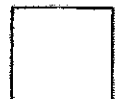

32. The diagram below shows a plant.

(a) Label the parts of the plant by writing in the boxes provided.

[1]

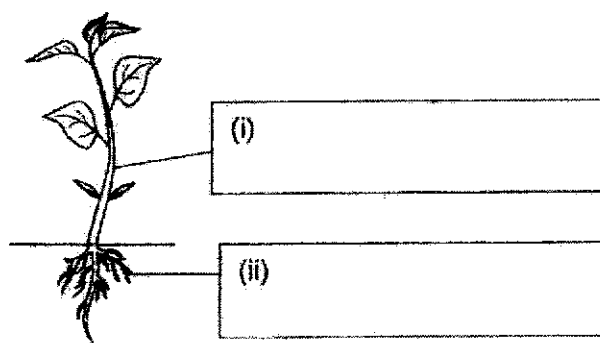

Sarah observed the plant for four months and recorded her findings below.

Month	Height of plant (cm)	Number of flowers
March	7	0
April	10	0
May	13	1
June	16	2

(b) Based on the above table, what characteristic of living things does the plant show?

[1]

(c) Based on the above table, flowers were not observed on the plant for the first two months. Give a reason for this observation.

[1]



33. Study the following statements.

(a) State whether the statements are true or false by putting a tick (✓) in the correct box. [2]

Statements	True	False
All plants reproduce by seeds.		
Plants have four stages in their life cycle.		
The leaves make food for the germinating seed.		
Tiny openings on leaves help the plant take in and give out gases.		

Olivia placed two similar plants into two similar beakers. She removed some roots from the plant in set-up P. She recorded the water levels in the beakers daily.

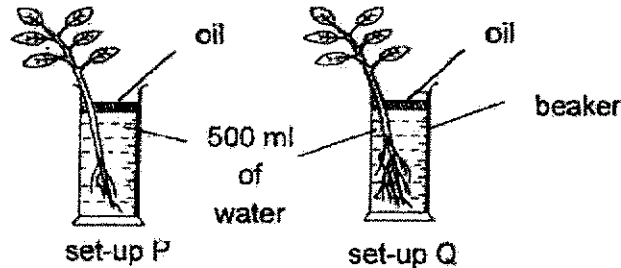

She recorded her results in the graph below.

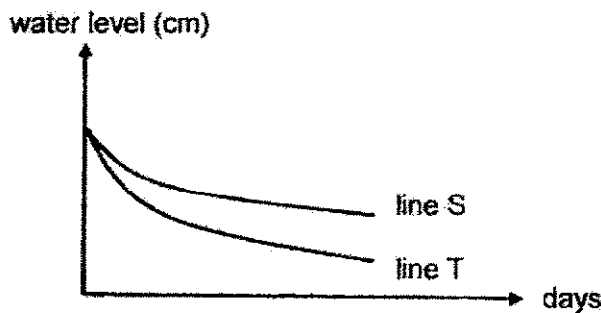

(b) Which line S or T represents the results obtained for set-up P and Q? Write "S" or "T" in the blanks provided. [1]

Set-up P: _____

Set-up Q: _____

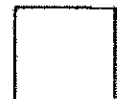

34. Rahim observed two animals P and Q and recorded their characteristics in the table as shown below.

Characteristics	Animal P	Animal Q
Type of body covering	Hard outer covering	Hair
Method of reproduction	Lays eggs	Gives birth to young
Number of legs	Eight legs	No legs

- (a) Rahim's mother told him that animal P is a grasshopper and one of its characteristics has been recorded wrongly. Which characteristic has been recorded wrongly? Explain your answer. [1]

- (b) State a function for the hard outer covering of animal P. [1]

- (c) Based on the table, which animal group would animal Q belong to? [1]

- (d) Based on the table, what could animal Q be? [1]



35. The diagram below shows the life cycle of animals W and X.

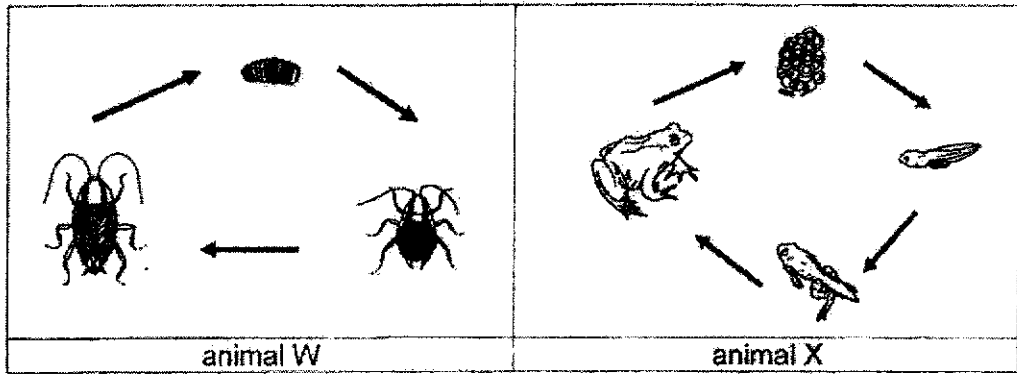

(a) State two differences between the life cycle of animals W and X. (Do not compare the size, shape or colour.) [2]

(i) _____

(ii) _____

(b) Name an animal that has the same life cycle as animal X. [1]

(c) Explain why animal W and X lay many eggs each time during reproduction. [1]



36. Matthew inflated a balloon and twisted it into the shape of a swan as shown below.



(a) Based on the diagram above, what properties of air does it show? [1]

Matthew placed another balloon into a plastic bottle as shown below.

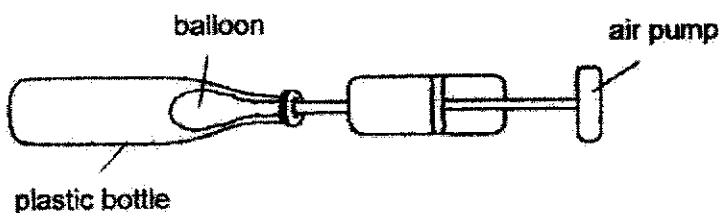

(b) He tried to inflate the balloon using an air pump but found it very difficult to do so. Explain why. [1]

(c) Suggest what Matthew can do to make it easier to inflate the balloon without removing the plastic bottle. [1]



37. John wanted to pack some clothes into a suitcase but it would not fit as shown in diagram 1.

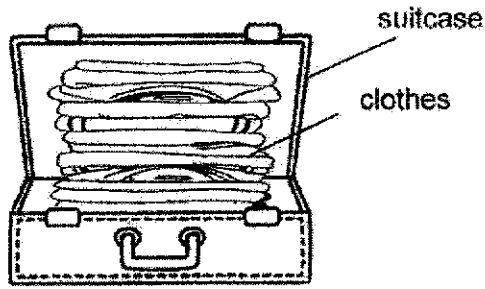

diagram 1

He placed the clothes in a bag and used a special device to remove the air from the bag. The bag was sealed after the air was removed as shown in diagram 2.

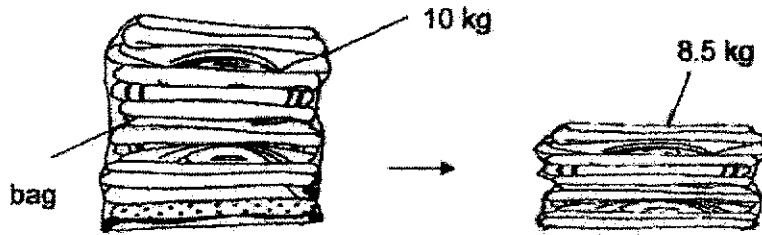

diagram 2

- (a) Why was there a change in the mass of the bag of clothes in diagram 2? [2]

- (b) Explain why he could fit all his clothes into the suitcase. [1]



38. Study the flow chart below.

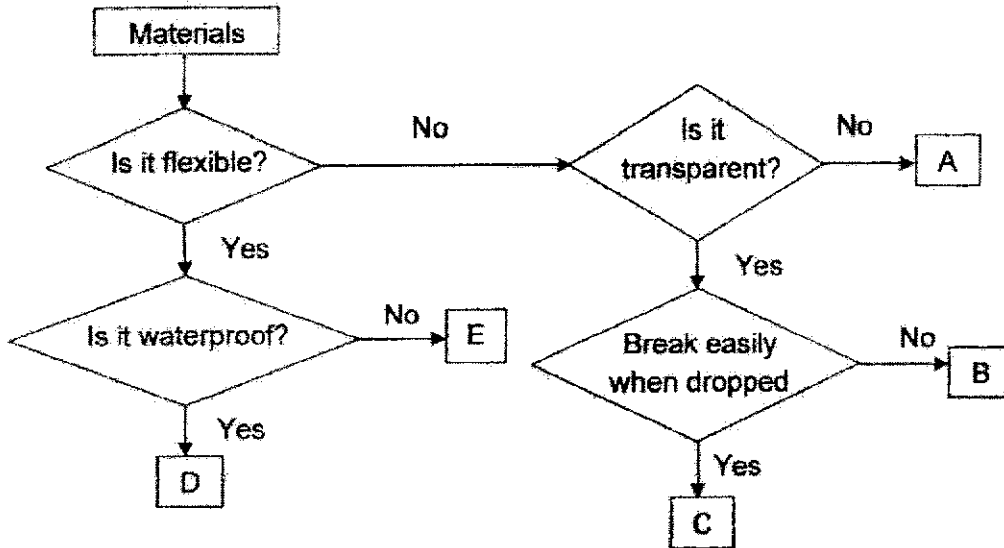

(a) Based on the flow chart, state a difference between material A and E. [1]

(b) Based on the flow chart, state two similarities between material B and C. [2]

(c) Based on the flow chart, match the objects below with the correct materials A, B, C, D or E in the blanks provided. [1]

(i)  hose _____

(ii)  coin _____



39. Weiming had two cut-outs A and B made from different materials as shown below.

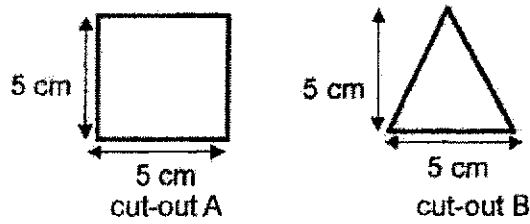

He conducted the following experiment in a dark room as shown below.

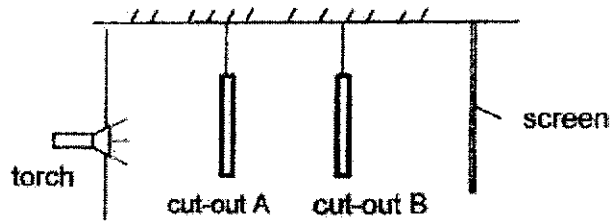

The following diagram shows the shadow formed on the screen when the torch was switched on.

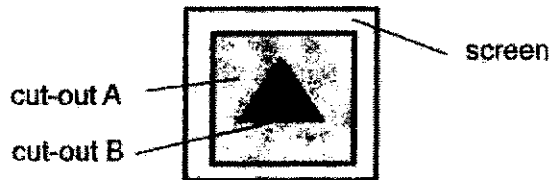

(a) Based on the diagram above, state the transparency of cut-outs A and B by putting a tick (✓) in the correct box. [2]

Cut-outs	Transparent	Translucent	Opaque
A			
B			

(b) Explain why Weiming has to conduct the experiment in a dark room. [1]

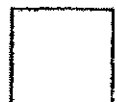

Weiming conducted another experiment. He stacked two pieces of material C and measured the amount of light that passed through material C as shown below.

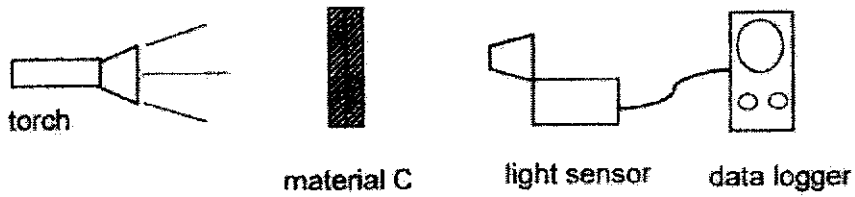

He repeated the experiment by stacking more pieces of material C together and recorded the results in the table below.

Number of pieces of material C stacked in front of light sensor	Amount of light recorded by the data logger (units)
2	1600
3	1300
4	1000
5	700

- (c) Based on the results above, state the relationship between the number of pieces of material C stacked together and the amount of light detected by the data logger. [1]

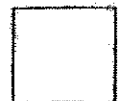

40. Study the diagram below.

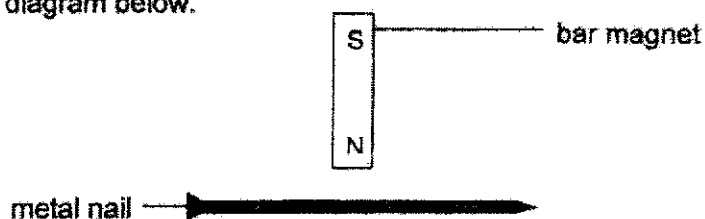

(a) Explain how Sam can magnetise the metal nail using the bar magnet.

[1]

Sam tried to magnetise some metal nails A, B, C and D as shown below. He then placed the metal nails near some paper clips.

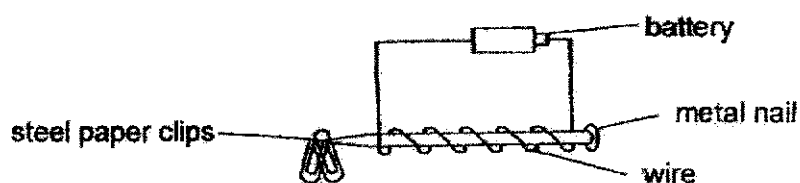

He recorded the number of paper clips attracted in the table below.

Nail	Number of coils	Number of steel paper clips attracted
A	30	8
B	50	15
C	70	25
D	90	0

(b) Explain why metal nail D was not able to attract any paper clips.

[1]

(c) Based on the results in the table, what can Sam conclude about the relationship between the number of coils and the magnetic strength of the metal nails A, B and C?

[1]

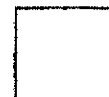

41. Moana conducted an experiment using two batteries and a wire coiled ten times around an iron nail. An object H, was attached to a toy car. The toy car was placed 4 cm away from the iron nail. She observed that the toy car moved away from the iron nail.

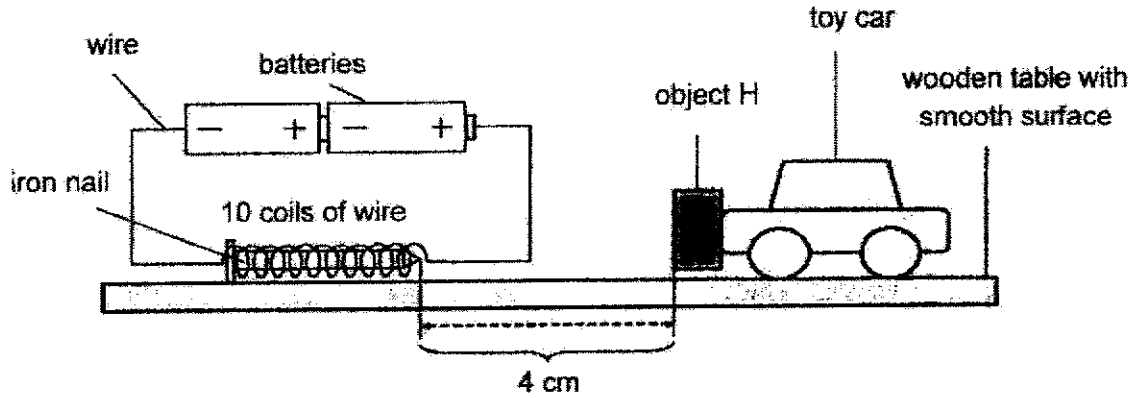

(a) Is object H a magnet or a magnetic object? [1]

(b) Explain your answer in (a). [1]

(c) Suggest two ways to increase the magnetic strength of the electromagnet. [2]

(i) _____

(ii) _____

END OF PAPER

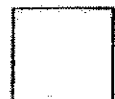

SCHOOL : CHIJ ST NICHOLAS GIRLS SCHOOL
 LEVEL : PRIMARY 4
 SUBJECT : SCIENCE
 TERM : SA 1

Q1	Q2	Q3	Q4	Q5	Q6	Q7	Q8	Q9	Q10
4	4	3	4	2	3	1	4	1	4
Q11	Q12	Q13	Q14	Q15	Q16	Q17	Q18	Q19	Q20
2	2	2	3	1	1	2	3	4	3
Q21	Q22	Q23	Q24	Q25	Q26	Q27	Q28		
4	3	3	1	2	3	4	1		

29	<p>a) It helps to break down food into simpler substance.</p> <p>b) Part Q absorbs digested food onto the bloodstream while Part P does not.</p> <p>c) The water from the undigested food will not be absorbed</p>								
30	<p>a) To see if plants need sunlight to survive.</p> <p>b) Plant A. It was covered with a black paper so it could not receive sunlight for it to make food for the plant.</p>								
31	<p>a) Mould</p> <p>b) Location Y. It was warm and it had moisture. Mould needs those two conditions to grow.</p> <p>c) He could put them in the fridge.</p>								
32	<p>a) I. Stem II. Roots</p> <p>b) Living things to grow</p> <p>c) The plants were still a young plant so it cannot bear flowers.</p>								
33	<table border="1" style="margin-left: 20px;"> <tbody> <tr><td>False</td><td><input checked="" type="checkbox"/></td></tr> <tr><td>False</td><td><input checked="" type="checkbox"/></td></tr> <tr><td>False</td><td><input checked="" type="checkbox"/></td></tr> <tr><td>True</td><td><input checked="" type="checkbox"/></td></tr> </tbody> </table> <p>a)</p> <p>b) Set-up P: S Set-up Q: T</p>	False	<input checked="" type="checkbox"/>	False	<input checked="" type="checkbox"/>	False	<input checked="" type="checkbox"/>	True	<input checked="" type="checkbox"/>
False	<input checked="" type="checkbox"/>								
False	<input checked="" type="checkbox"/>								
False	<input checked="" type="checkbox"/>								
True	<input checked="" type="checkbox"/>								
34	<p>a) The number of legs. A grasshopper is an insect and all insects have six legs but Rahim wrote eight legs from the number of legs animal P has.</p> <p>b) To protect its soft body.</p> <p>c) Mammal</p> <p>d) Dolphin</p>								
35	<p>a) i. The life cycle of Animal W occurs on land but the life cycle of Animal X occurs in the water.</p> <p>ii. Animal W's young looks like the adult but Animal X's young does not look like adult</p> <p>b) Toad</p>								

	c) If some eggs are damaged or eaten by predators, others will still hatch and develop into adults												
36	<p>a) Air does have a definite shape</p> <p>b) Air takes up place in the plastic bottle, the balloon blocked the hole so air could not escape from the plastic bottle so the balloon has not enough space to become bigger.</p> <p>c) He could poke a hole in the plastic bottle so air could scape.</p>												
37	<p>a) Air has mass. When the air in the bag was removed, there was lesser air in the bag so the mass of the bag decreased.</p> <p>b) The size of the bag became smaller after air was removed from the bag.</p>												
38	<p>a) Material A is not flexible but Materials E is flexible.</p> <p>b) Both material are transparent. Both are not flexible.</p> <p>c) i. D ii. A</p>												
39	<table border="1" data-bbox="502 712 1193 891"> <thead> <tr> <th>Cut-outs</th> <th>Transparent</th> <th>Translucent</th> <th>Opaque</th> </tr> </thead> <tbody> <tr> <td>A</td> <td></td> <td style="text-align: center;">✓</td> <td></td> </tr> <tr> <td>B</td> <td></td> <td></td> <td style="text-align: center;">✓</td> </tr> </tbody> </table> <p>a)</p> <p>b) A dark room ensures that any light shining on the material comes only from the torch.</p> <p>c) The more pieces of material C stacked together, lesser light was detected by the data logger</p>	Cut-outs	Transparent	Translucent	Opaque	A		✓		B			✓
Cut-outs	Transparent	Translucent	Opaque										
A		✓											
B			✓										
40	<p>a) He could use the same poles of the bar magnet to stroke the metal nail in the same direction repeatly.</p> <p>b) The nail is not made of a magnetic material.</p> <p>c) As the number of coils increases, the magnetic strength of the metal nails A and B increases too.</p>												
41	<p>a) Object H is a magnet</p> <p>b) The tou car moved away from the iron nail showing that there is replusion as the like poles are facing each other.</p> <p>c) i. He could add more batteries to the electromagne. ii. He could coil more around the iron nail.</p>												