



**Anglo-Chinese School**  
**(Primary)**  
A Methodist Institution  
(Founded 1886)

**SEMESTRAL ASSESSMENT ONE 2021**  
**SCIENCE**  
**PRIMARY FOUR**  
**BOOKLET A**

Name: \_\_\_\_\_ (    )

Class: Primary 4 \_\_\_\_\_

Date: 17 May 2021

Duration of paper: 1 h 45 min

Additional Materials: Optical Answer Sheet (OAS)

**INSTRUCTIONS TO CANDIDATES**

1. Write your name, index number and class in the spaces provided.
2. Do not turn this page until you are told to do so.
3. Follow all instructions carefully.
4. Answer all questions.
5. Shade your answer on the Optical Answer Sheet (OAS) provided.

**This question paper consists of 18 printed pages including this cover page.**



For each question from 1 to 28, four options are given. One of them is the correct answer. Make your choice (1, 2, 3 or 4) and shade your answer on the Optical Answer Sheet.

(56 marks)

1 The following objects are grouped according to their \_\_\_\_\_.

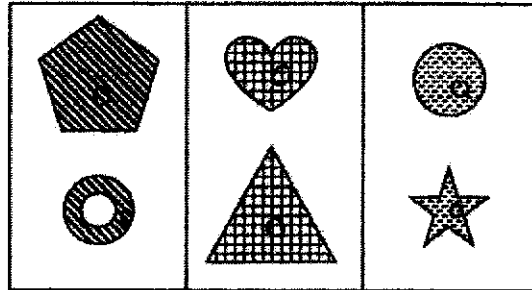

- (1) sizes
- (2) shapes
- (3) patterns
- (4) number of sides

2 Ameen observes two animals, P and Q, and classifies them as shown.

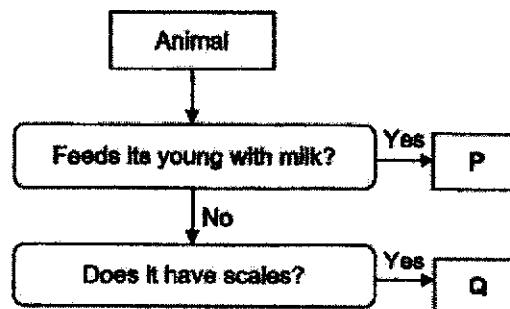

Which of the following groups of animals can P and Q belong to?

	P	Q
(1)	Fish	Mammal
(2)	Fish	Reptile
(3)	Mammal	Amphibian
(4)	Mammal	Reptile

(Go on to the next page)

- 3 Four living things, S, T, U and V, are classified as shown.

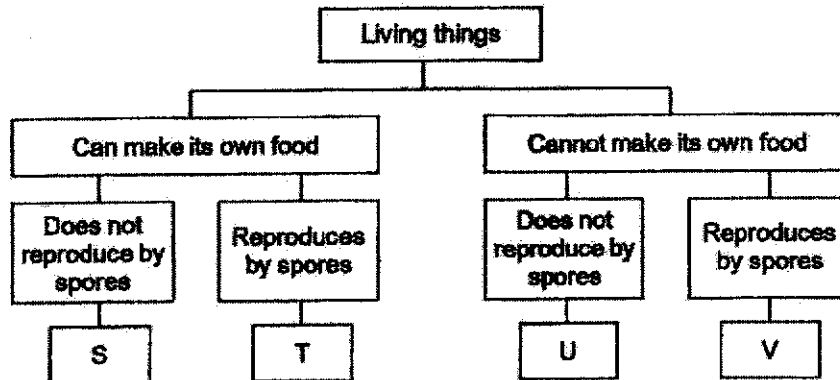

Three of the living things are represented below. Which of the following correctly represents them?

	Bread mould	Fern	Tomato plant
(1)	V	T	U
(2)	T	V	U
(3)	V	T	S
(4)	T	V	S

(Go on to the next page)

- 4 Three ring magnets were placed one at a time through a wooden rod. The observation is as shown.

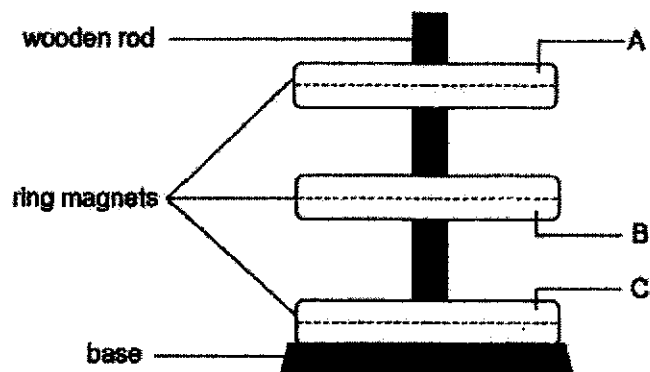

What would be the poles on the sides labelled A, B and C?

	A	B	C
(1)	North	South	South
(2)	South	South	South
(3)	North	North	South
(4)	South	North	South

- 5 Kenneth wanted to test the strength of a bar magnet at three points, X, Y and Z, as shown. He then placed the bar magnet into a container filled with paper clips.



Which of the following point(s) will attract the least paper clips when the magnet was taken out of the container?

- (1) X only
- (2) Y only
- (3) X and Y only
- (4) X and Z only

(Go on to the next page)

- 6 Five magnets were arranged such that they attracted another magnet as shown. The magnetic poles of A and B are also shown.

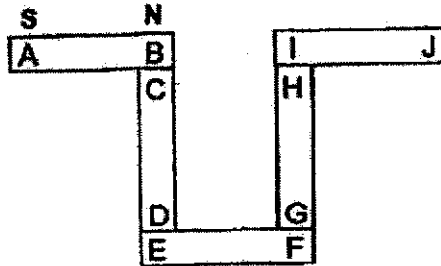

Which of the following arrangements is not possible?

<p>(1)</p>	<p>(2)</p>
<p>(3)</p>	<p>(4)</p>

- 7 A magnet was used to stroke four different materials.  
Which of the following materials will become a magnet using the stroke method?

- (1) steel
- (2) wood
- (3) copper
- (4) aluminium

(Go on to the next page)

- 8 Joel carried out an experiment with four rods, A, B, C and D. He brought a bar magnet near one end of each rod and observed what happened.

Rod A P 

Rod B Q 

Rod C R 

Rod D S 

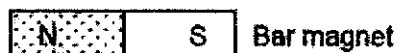

He recorded his observations in the table below.

Rod	Observations
A	Attracted by the N-pole of the bar magnet.
B	Repelled by the N-pole of the bar magnet.
C	Attracted by the S-pole of the bar magnet.
D	No interaction when brought near to the bar magnet.

Based on the observations above, which rod is definitely a magnet?

- (1) Rod A
- (2) Rod B
- (3) Rod C
- (4) Rod D

(Go on to the next page)

- 9 Study the classification chart carefully.

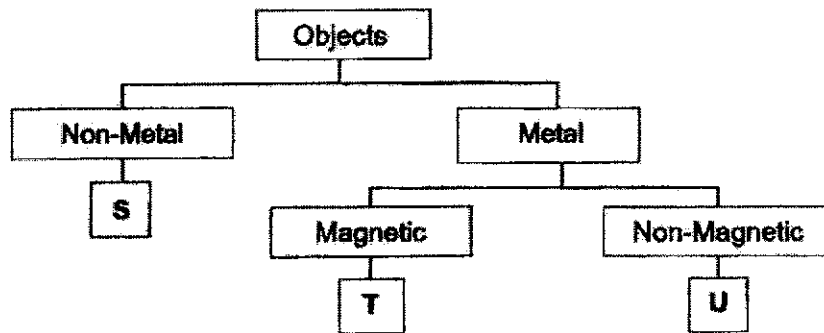

Which materials could objects, S, T and U be made of?

	S	T	U
(1)	gold	silver	ceramic
(2)	rubber	iron	copper
(3)	plastic	steel	iron
(4)	wood	copper	aluminium

- 10 Which human body system is involved in the exchanging of gases with the surrounding?

- (1) skeletal
- (2) muscular
- (3) circulatory
- (4) respiratory

(Go on to the next page)



- 11 Randy made a puppet using some pieces of wood and strings as shown.

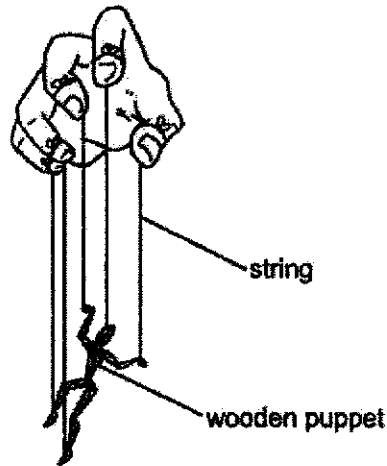

The wooden puppet moves when Randy pulls the strings. What body systems do the wooden puppet and strings represent?

	Wooden puppet	Strings
(1)	Muscular	Circulatory
(2)	Skeletal	Circulatory
(3)	Digestive	Muscular
(4)	Skeletal	Muscular

- 12 Which statements correctly describe the functions of the mouth in the digestion of food?

- A Starts digesting food.
- B Absorbs some digested food.
- C Cuts food into smaller pieces.
- D Warms food up before swallowing.

- (1) A and C
- (2) B and C
- (3) A, B and C
- (4) A, B, C and D

(Go on to the next page)

- 13 The diagram shows the human digestive system.

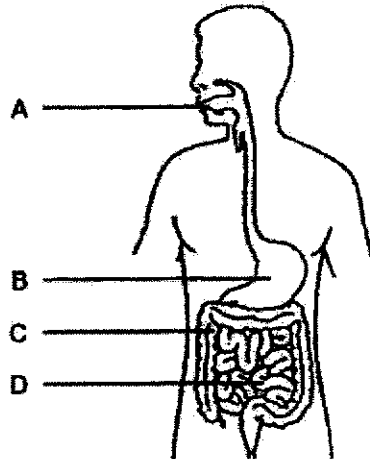

Which part absorbs water from undigested food?

- (1) A
  - (2) B
  - (3) C
  - (4) D
- 14 The diagram shows a plant growing around a pole.

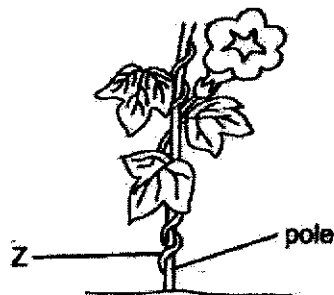

Based on the diagram only, describe the function of part Z.

- (1) It develops into a fruit.
- (2) It traps light to make food for the plant.
- (3) It exchanges gases with the surrounding.
- (4) It climbs upwards for the plant to grow towards light.

(Go on to the next page)

- 15 The diagram shows a young plant.

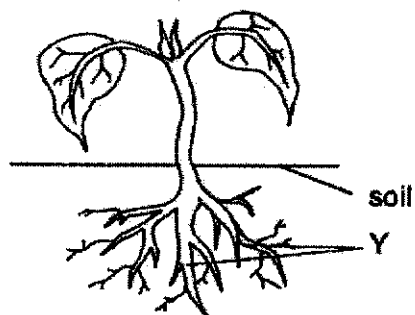

Which of the following are the functions of part Y?

- A Holds the plant upright
  - B Anchors the plant firmly
  - C Absorbs water and minerals
  - D Exchanges minerals with the soil
- (1) A and C
- (2) B and C
- (3) A, B and C
- (4) A, B, C and D

(Go on to the next page)

Use the graph below to answer Questions 16 and 17.

The graph shows the temperature changes of the water in a kettle over some time.

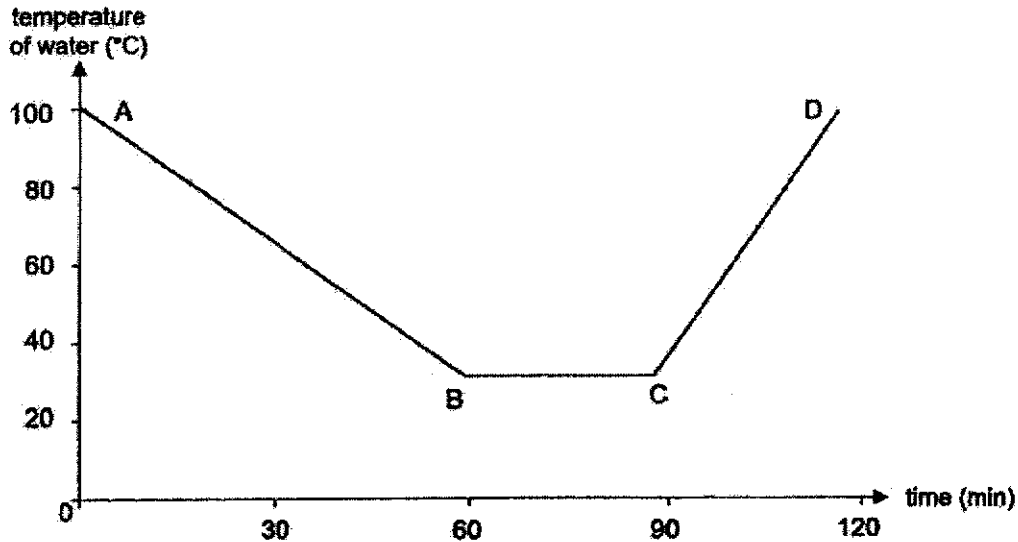

16 Which of the following most likely caused the temperature of water to drop during part AB?

- (1) The water gained heat from the kettle.
- (2) More hot water was added to the kettle.
- (3) The water was being heated in the kettle.
- (4) The water was left on the table at room temperature.

17 Which part(s) of the graph show(s) that heat is being gained by the water?

- (1) AB only
- (2) BC only
- (3) CD only
- (4) BC and CD only

(Go on to the next page)

18 Which of the following statements about heat is true?

- (1) Heat is a form of energy.
- (2) Heat loss causes an increase in temperature.
- (3) Heat travels from a colder place to a hotter place.
- (4) Heat is a measurement of the degree of hotness of an object.

19 In the set-up shown, the metal ball is able to pass through the metal ring completely.

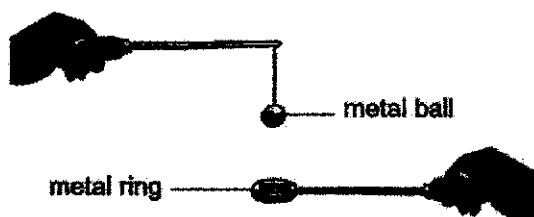

Which of the following are possible ways to stop the metal ball from passing through the metal ring?

- A Dip only the metal ball in cold water.
  - B Dip only the metal ring in cold water.
  - C Heat only the metal ball over a flame.
  - D Heat only the metal ring over a flame.
- 
- (1) A and C only
  - (2) A and D only
  - (3) B and C only
  - (4) B and D only

(Go on to the next page)

- 20 Elle wants to keep her ice cream as cold as possible while she is eating it.

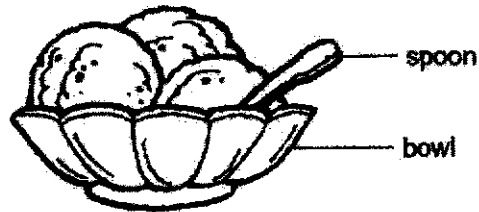

Which types of bowl and spoon should she use in order to do so?

- (1) Steel bowl and steel spoon.
  - (2) Steel bowl and wooden spoon.
  - (3) Plastic bowl and steel spoon.
  - (4) Plastic bowl with wooden spoon.
- 21 Daniel poured equal volumes of water from beakers P and Q into an empty beaker R as shown.

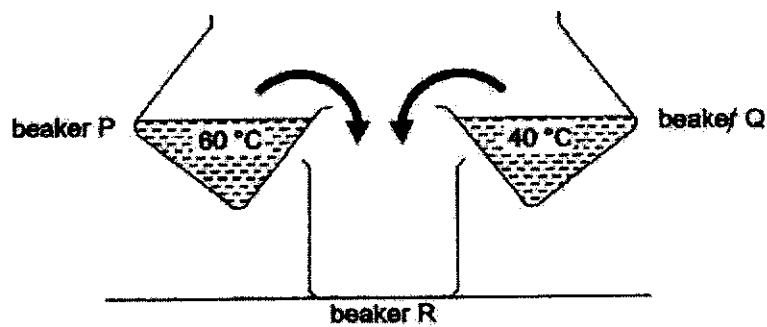

Which of the following is most likely the temperature of the water in beaker R?

- (1) 20 °C
- (2) 50 °C
- (3) 60 °C
- (4) 100 °C

(Go on to the next page)

- 22 The diagram shows the changes in states of matter.

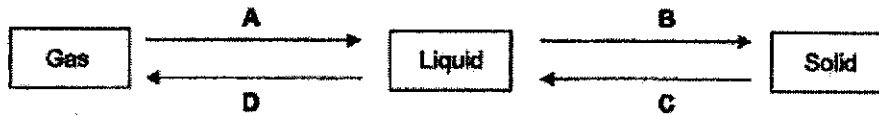

Which of the following correctly represents the letters, A, B, C and D, in the diagram?

	A	B	C	D
(1)	lose heat	lose heat	gain heat	gain heat
(2)	lose heat	gain heat	lose heat	gain heat
(3)	gain heat	lose heat	lose heat	gain heat
(4)	gain heat	gain heat	lose heat	lose heat

- 23 Which of the following is a source of light?

(1) The moon



(2) An apple



(3) A fire



(4) A tree



(Go on to the next page)

24 Which pair of arrows helps explain why the boy is able to see the toy car?

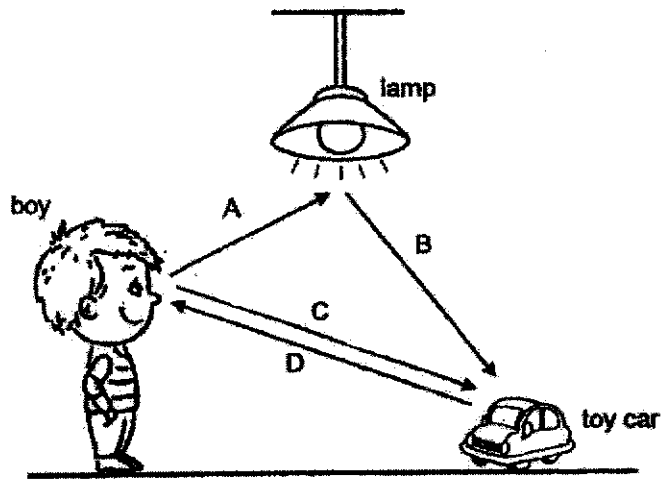

- (1) A and B
- (2) B and C
- (3) B and D
- (4) C and D

(Go on to the next page)



- 25 The length of the cat's shadow on the ground changed as it was walking from Point A to Point C under a lit street lamp in the night.

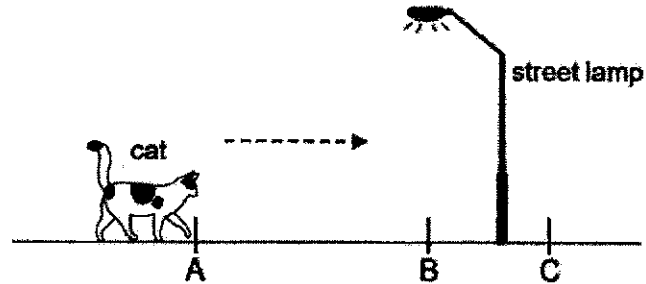

Which of the following graphs represents the change in the length of shadow?

(1) length of shadow

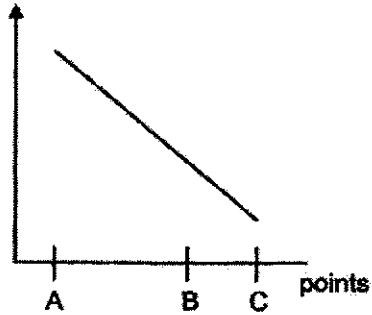

(2) length of shadow

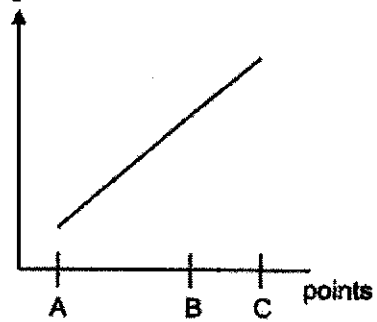

(3) length of shadow

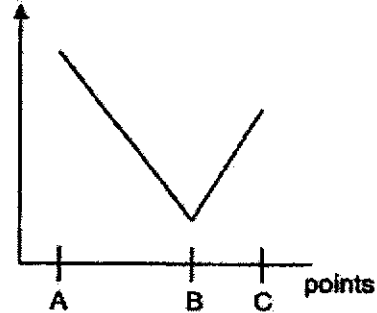

(4) length of shadow

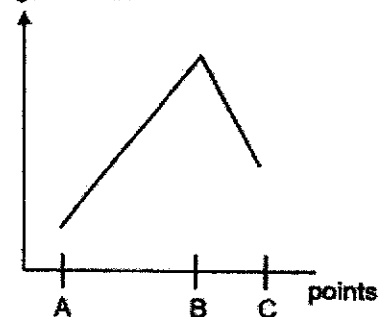

(Go on to the next page)

26 John shines a torch at a ceramic mug from different positions and observes the shadows formed.

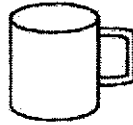

Which shape does not represent the shadows formed?

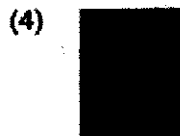

27 Three sheets, A, B and C, are made of different materials. When the torch was switched on, a bright patch of light was observed on the screen.

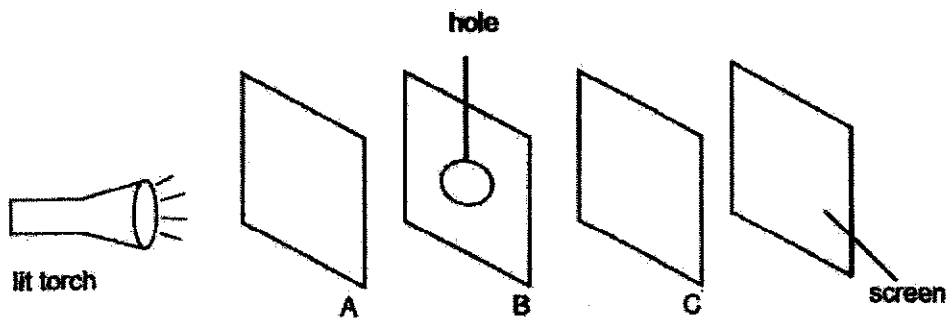

Which of the following represent the materials in which A, B and C, are made of?

	A	B	C
(1)	Tracing paper	Clear plastic	Wood
(2)	Clear glass	Iron	Tracing paper
(3)	Clear glass	Iron	Clear plastic
(4)	Wood	Clear glass	Clear plastic

(Go on to the next page)

- 28 The periscope below uses two mirrors to reflect light to allow a person to see an object as shown.

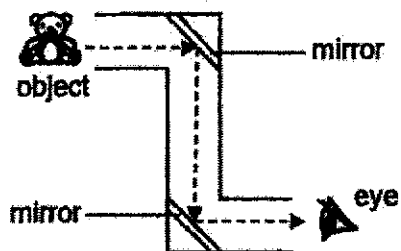

Jian Yong designed his own periscope as shown below. He had placed a mirror wrongly and could not see the object.

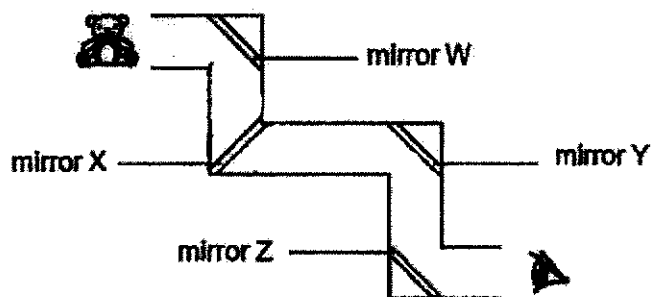

Which mirror must be placed correctly in order for Jian Yong to see the object?

- (1) W
- (2) X
- (3) Y
- (4) Z

**End of Booklet A**  
Please go on to booklet B



**Anglo-Chinese School  
(Primary)**

A Methodist Institution  
(Founded 1868)

**SEMESTRAL ASSESSMENT ONE 2021  
SCIENCE  
PRIMARY FOUR  
BOOKLET B**

Name: \_\_\_\_\_ ( )

Class: Primary 4 \_ \_

Date: 17 May 2021

Duration of paper: 1 h 45 min

**INSTRUCTIONS TO CANDIDATES**

1. Write your name, index number and class in the spaces provided.
2. Do not turn this page until you are told to do so.
3. Follow all instructions carefully.
4. Answer all questions.
5. Write your answers in this booklet.

BOOKLET	MAX MARKS	MARKS OBTAINED
A	56	
B	44	
Total	100	

This question paper consists of 13 printed pages including this cover page.

For questions 29 to 40, write your answers in the spaces provided in this booklet.  
The number of marks available is shown in brackets [ ] at the end of each question or part question.  
(44 marks)

- 29 Samuel placed three similar slices of bread A, B and C, in different conditions. The observations he made after one week are shown in the diagram below.

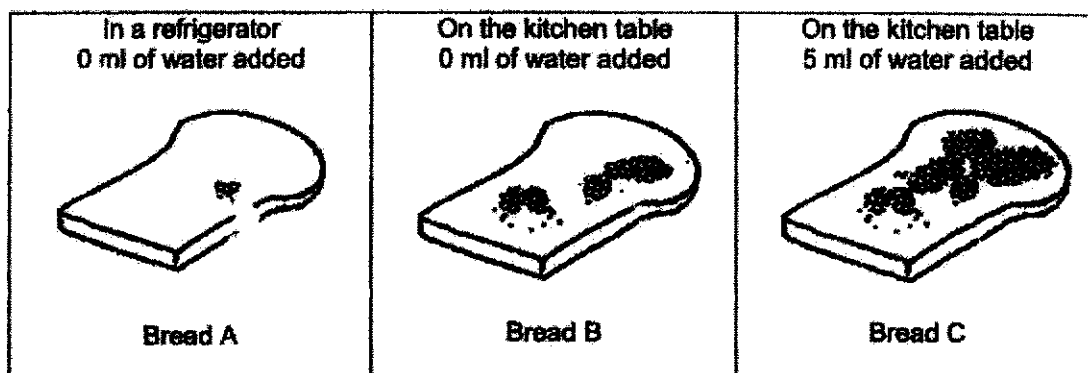

- (a) Which group of living things does bread mould belong to? [1]

\_\_\_\_\_

- (b) Which two breads should he compare to conclude that water is needed for bread mould to grow? [1]

Breads \_\_\_\_\_ and \_\_\_\_\_

- (c) Based on Samuel's observations,  
(i) which bread, A, B or C, was placed in conditions that caused the least bread mould to grow? [1]

Bread \_\_\_\_\_

- (d) (ii) circle the correct answers below. [1]

Mould is also found to grow on leather shoes. Leather shoes should be kept in a place that is ( *warm / cool* ) and ( *dry / wet* ) so that they would not be mouldy easily.

(Go on to the next page)

SCORE	4
-------	---

- 30 Andrew coiled a wire around a metal nail. He then connected the ends of the wire to a battery. The metal nail became magnetised and attracted some paper clips as shown.

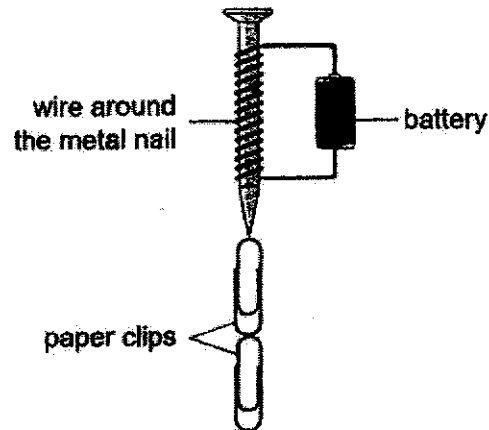

- (a) Name the method used by Andrew to magnetise the metal nail. [1]

---

- (b) What would Andrew observe about the paper clips if the battery was removed? [1]

---

- (c) Suggest two changes that Andrew should make to the set-up so that the metal nail could attract more paper clips. [2]

1. 

---

2. 

---

(Go on to the next page)

SCORE	4
-------	---

31 The diagram shows the human digestive system.

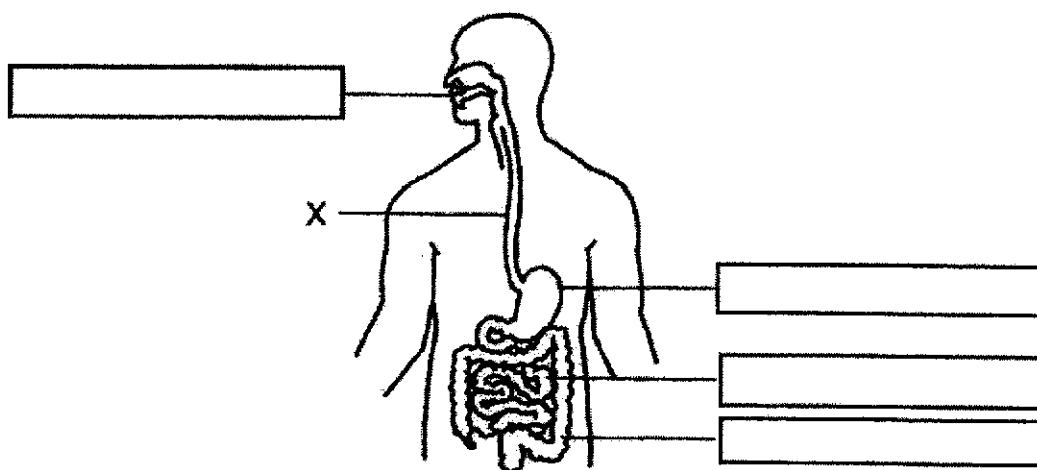

(a) Name part X. [1]

\_\_\_\_\_

(b) Label the 'small intestine' and 'stomach' in the two correct boxes above. [2]

(c) Based on the functions of the small intestine and stomach,

(i) state one similarity in their functions. [1]

\_\_\_\_\_

(ii) state one difference in their functions. [1]

\_\_\_\_\_

\_\_\_\_\_

(Go on to the next page)

SCORE	/
	5

32 Classify the following six items correctly under the given headings. [3]

nickel coin	silver ring	woollen jacket
burning wood	plastic box	Sun

Not a source of heat	A source of heat

33 Xiao Min prepared two identical cups to cook instant noodles as shown. She put the same amount of uncooked instant noodles into each cup and measured the time taken for them to cook.

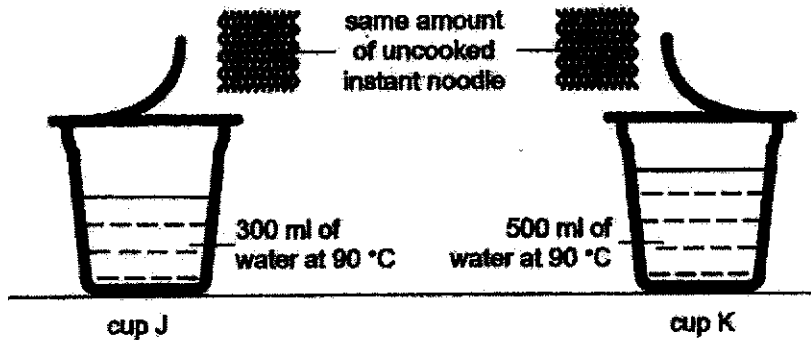

(a) In which cup, J or K, would the instant noodle be cooked faster? [1]

\_\_\_\_\_

(b) Explain your answer in part (a). [1]

\_\_\_\_\_

\_\_\_\_\_

(Go on to the next page)

SCORE	5
-------	---



6

- 34 Pat wrapped a container of soup material A as shown. She then wrapped an identical container that had the same amount of soup with material B.

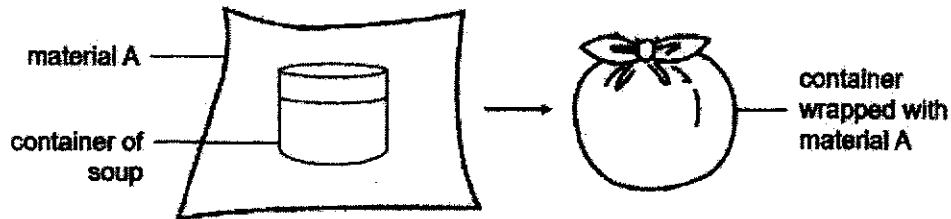

The starting temperature of the soup was 100 °C. Pat recorded the temperature of the soup in the container after 20 minutes below.

Material used to wrap the container	Temperature of soup in the container after 20 minutes (°C)
A	60
B	80

- (a) Based on the results, which material, A or B, is a better conductor of heat? Explain your answer. [2]

---



---

Pat then wrapped another identical container that had the same amount of soup with two layers of material A. The starting temperature of the soup was 100 °C. After 20 minutes, it was 75 °C.

- (b) Explain why the temperature of soup after 20 minutes was higher when two layers of material A were used to wrap the container, instead of one layer. [1]

---



---

- (c) Predict the temperature of the soup after 20 minutes if no material was used to wrap the container. [1]

\_\_\_\_\_ °C

(Go on to the next page)

SCORE	4
-------	---

- 35 Suri held a metal spoon with a cube of ice as shown. After some time, she noted that the metal spoon felt cold.

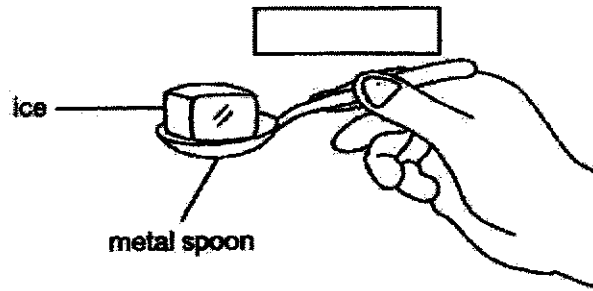

- (a) Draw an arrow ( $\leftarrow$  or  $\rightarrow$ ) in the box (  ) above to show the direction of heat flow between the metal spoon and Suri's hand. [1]
- (b) Why the metal spoon felt cold to Suri? [1]
- 
- 
- (c) The temperature of an object cannot be accurately measured using our hands. Name a measuring instrument that is able to measure temperature accurately. [1]
- 

(Go on to the next page)

SCORE	1
	3

- 36 A railway company wanted to find out how much different types of metals expand when heated. It conducted Experiment 1 where metal rods, A, B and C, made of different metals were heated as shown. However, it did not conduct a fair test.

**Experiment 1**

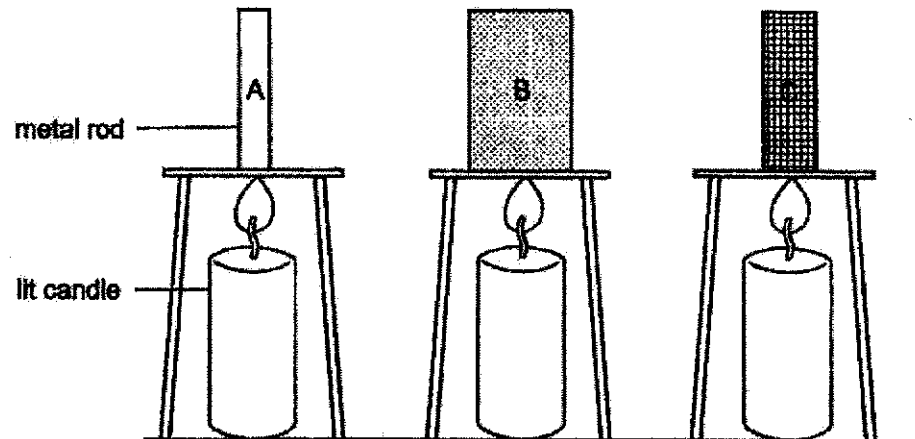

- (a) Based on the aim of Experiment 1, which variable should be changed and kept the same for a fair test to be conducted?

Tick (✓) in the correct boxes below.

[2]

Variable	To be changed	To be kept the same
Material of metal rods		
Thickness of the metal rods		

(Go on to the next page)

The company changed the experiment and conducted Experiment 2 which was a fair test. The results of Experiment 2 are shown in the graph below.

**Experiment 2**

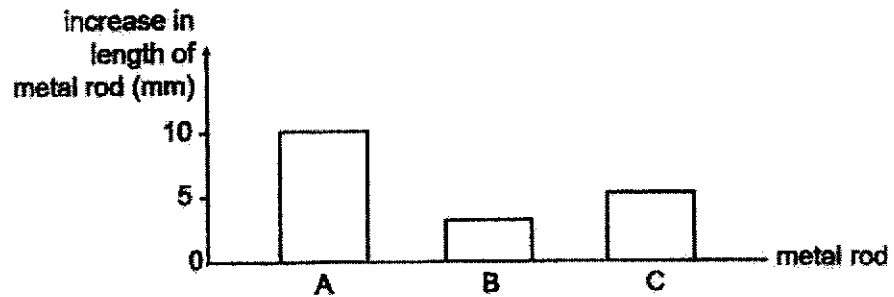

- (b) The company wants to make metal railway tracks in a very hot and sunny country. Based on the result of Experiment 2, which metal, A, B or C, is the most suitable to make the railway tracks? Explain your answer. [2]

---



---

The figure below shows part of a metal railway track. Gaps are observed between the tracks.

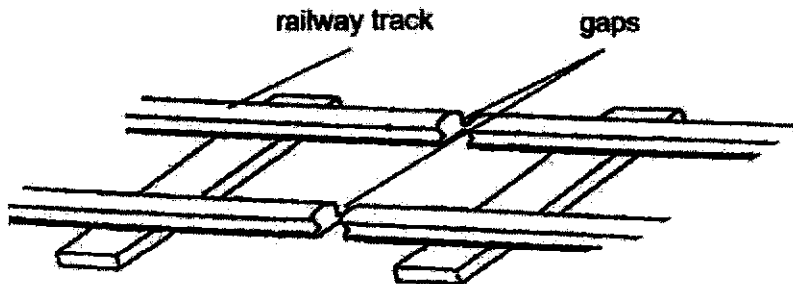

- (c) Based on the results of Experiment 2 and the diagram above, what will happen to a long metal railway track with no gaps on a very hot and sunny day? [1]

---



---

(Go on to the next page)

SCORE	5
-------	---

- 37 Ben and Jason looked through two different black tubes to see if they could observe a candle flame at the opposite end.

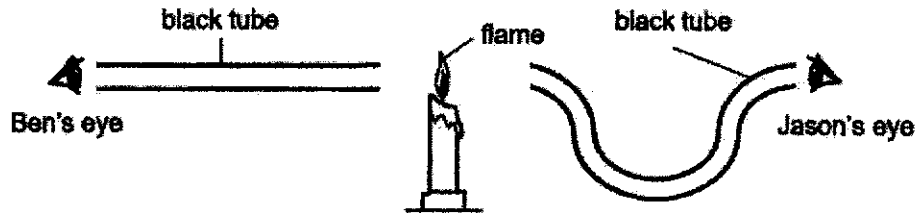

Ben could see the flame through his tube but Jason could not.

- (a) State the property of light that explains this observation. [1]

---

- (b) How was Ben able to see the flame, but not Jason? [1]

---

Jason placed material X to cover one end of Ben's tube as shown. However, Ben was still able to see the flame as clearly as before.

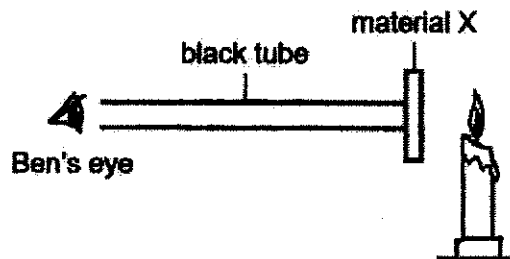

- (c) What does this observation show about the property of material X? [1]

(Go on to the next page)

SCORE	3
-------	---

- 38 Adam placed an object in front of the light source to form a shadow on the white wall.

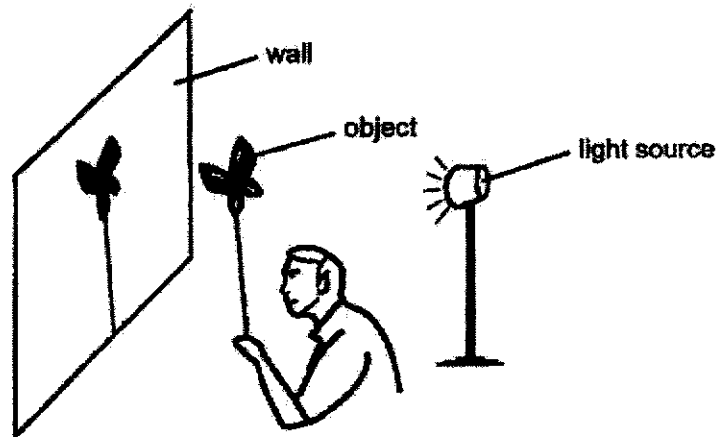

- (a) Moving only the object, what could Adam do to make the shadow bigger? [1]

---

- (b) Moving only the light source, what could Adam do to make the shadow smaller? [1]

---

(Go on to the next page)

SCORE	/
	2

- 39 Harry placed two objects, a frosted glass and a wooden plate, in front of a lit torch as shown.

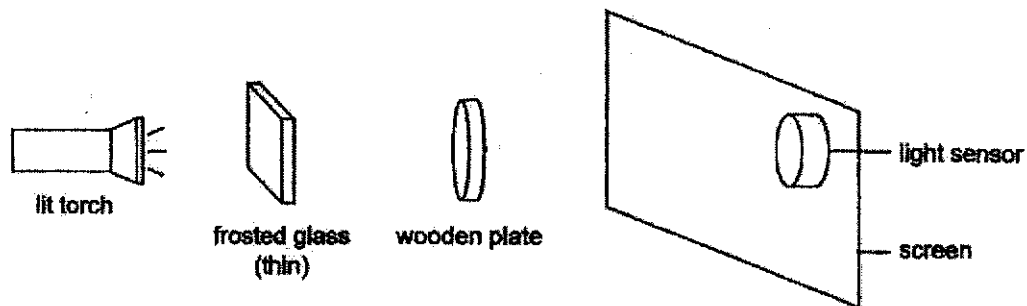

- (a) Which of the following represents the shadow formed on the screen? Tick (✓) in the correct box below. [1]

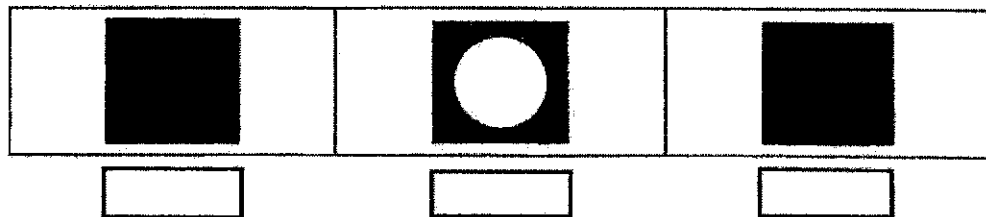

- (b) Harry then moved the lit torch closer to the screen. Would the amount of light detected by the light sensor increase, decrease or remain the same? [1]

---

Using one of the objects above, Harry made a box to keep a toy. He was able to see the toy inside the box but not clearly as shown.

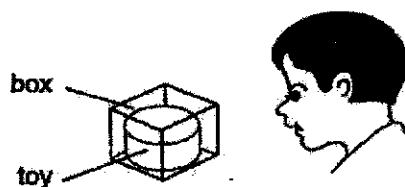

- (c) Which object, the frosted glass or the wooden plate, did Harry made the box from? Explain your answer. [2]

---



---

(Go on to the next page)

SCORE	4
-------	---

- 40 Matthew used a light sensor to measure the amount of light passing through fabric Z of different thickness. The results were recorded in the table below.

Thickness of fabric Z (mm)	Amount of light passing through (units)
1	20
3	5
5	0

- (a) State the relationship between the thickness of fabric Z and the amount of light passing through it. [1]

---



---

- (b) Based on the results, what is the amount of light that would pass through fabric Z with a thickness of 6 mm? [1]

---

- (c) Matthew's results were not reliable. What could he do to make sure his results are more reliable? [1]

---

Matthew wanted curtains to completely block out sunlight from entering his room. He used fabric Z with a thickness of 3 mm to make the curtains.

- (d) Based on his results, would Matthew's room be completely dark when he fully closed the curtains during a bright day? Explain your answer. [2]

---



---

**End of Booklet B / End of Paper**

**Please check your answers**



SCORE	5
-------	---

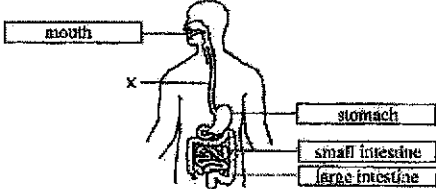

**SCHOOL** : **ANGLO-CHINESE SCHOOL**  
**LEVEL** : **PRIMARY 4**  
**SUBJECT** : **SCIENCE**  
**TERM** : **SA 1**

Q1	Q2	Q3	Q4	Q5	Q6	Q7	Q8	Q9	Q10
3	4	3	2	2	1	1	2	2	4
Q11	Q12	Q13	Q14	Q15	Q16	Q17	Q18	Q19	Q20
4	1	3	4	4	4	3	1	3	4
Q21	Q22	Q23	Q24	Q25	Q26	Q27	Q28		
2	1	3	3	3	1	3	2		

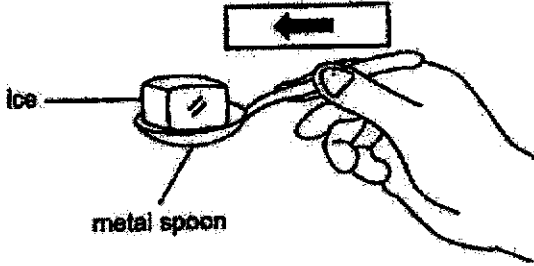
Q29	<p>a) Fungi  b) Breads B and C  c) Bread A  d) Cool: Dry</p>								
Q30	<p>a) Electrical method  b) The paper clips will fall off  c) 1. Increase the number of batteries.  2. Increase the number of coils of electrical wire around the nail.</p>								
Q31	<p>a) Gullet</p>  <p>b)</p> <p>i) Both produce digestive juice to digest food.  ii) Small intestine absorbs digested food but not the stomach.</p>								
Q32	<table border="1"> <thead> <tr> <th>Not a source of heat</th> <th>A source of heat</th> </tr> </thead> <tbody> <tr> <td>Nickel coin</td> <td>Burning wood</td> </tr> <tr> <td>Silver ring woollen jacket</td> <td>Sun</td> </tr> <tr> <td>Plastic box</td> <td></td> </tr> </tbody> </table>	Not a source of heat	A source of heat	Nickel coin	Burning wood	Silver ring woollen jacket	Sun	Plastic box	
Not a source of heat	A source of heat								
Nickel coin	Burning wood								
Silver ring woollen jacket	Sun								
Plastic box									
Q33	<p>a) K  b) K contains a greater amount of water, so its has a greater amount of heat to cook the noodle</p>								
Q34	<p>a) A. The temperature of soup in A is lower, so heat is lost more quickly from A to surroundings.  b) Two layers of materials (which has more trapped air) is a poor conductor of heat, so heat lost from the soup is lower.  c) Any number from 0 to 59</p>								

Q35	 <p>a) _____  b) Suri's hand heat to the cooler spoon.  c) Thermometer</p>											
Q36	<table border="1" data-bbox="445 663 1323 927"> <thead> <tr> <th data-bbox="445 663 743 701">Variable</th> <th data-bbox="743 663 1035 701">To be changed</th> <th data-bbox="1035 663 1323 701">To be kept the same</th> </tr> </thead> <tbody> <tr> <td data-bbox="445 701 743 813">Material of metal rods</td> <td data-bbox="743 701 1035 813" style="text-align: center;">✓</td> <td data-bbox="1035 701 1323 813"></td> </tr> <tr> <td data-bbox="445 813 743 927">Thickness of the metal rod</td> <td data-bbox="743 813 1035 927"></td> <td data-bbox="1035 813 1323 927" style="text-align: center;">✓</td> </tr> </tbody> </table> <p>a) _____  b) B. it expand the least of hot days.  c) The tracks expand and push against each other</p>			Variable	To be changed	To be kept the same	Material of metal rods	✓		Thickness of the metal rod		✓
Variable	To be changed	To be kept the same										
Material of metal rods	✓											
Thickness of the metal rod		✓										
Q37	<p>a) Light travels in at straight line  b) Tube was traight and light from the flame can travel into Ben's eyes.  c) Move the light source away from the object</p>											
Q38	<p>a) Move the object further away from the way. OR move the obbject towards the light source.  b) Move the light source away from the object.</p>											
Q39	 <p>a) _____  b) Increase  c) Frosted glass. Frosted glass allows some light to pass though.</p>											
Q40	<p>a) As the thickness of Z increases, the amount of light passing through it decreases.  b) 0 unit  c) Conduct the experiment two more times.  d) No. Some light will pass through the fabric.</p>											