

3

Name : \_\_\_\_\_ (    )

Class : Primary 4 \_\_\_\_\_

**CHIJ ST NICHOLAS GIRLS' SCHOOL (PRIMARY)**



**Primary 4 Mathematics**

**2016 Semestral Assessment Two**

**Booklet A**

**25 October 2016**

**TOTAL TIME FOR BOOKLETS A AND B: 1 HOUR 45 MINUTES**

Do not turn over this page until you are told to do so.  
Follow all instructions carefully.  
Answer all questions.

This booklet consists of 10 printed pages including the cover page.

**Section A: (20 x 2 marks)**

For each question, four options are given. One of the options is the correct answer. Shade the correct oval (1, 2, 3 or 4) on the Optical Answer Sheet. Please use only 2B pencil and SHADE the oval completely.

---

1. 88 thousands and 5 tens is the same as \_\_\_\_\_.
  - 1) 885
  - 2) 8850
  - 3) 88005
  - 4) 88050
  
2. Which of the following numbers when rounded off to the nearest ten becomes 22 500?
  - 1) 22 444
  - 2) 22 496
  - 3) 22 506
  - 4) 22 554
  
3. How many one-fifths are there in 3 wholes?
  - 1)  $\frac{3}{5}$
  - 2)  $1\frac{2}{3}$
  - 3) 5
  - 4) 15

4. Arrange the following fractions from the greatest to the smallest.

$$\frac{2}{3}, \frac{5}{6}, \frac{7}{12}$$

- (greatest)                      (smallest)
- 1)  $\frac{7}{12}, \frac{5}{6}, \frac{2}{3}$
- 2)  $\frac{5}{6}, \frac{2}{3}, \frac{7}{12}$
- 3)  $\frac{2}{3}, \frac{7}{12}, \frac{5}{6}$
- 4)  $\frac{2}{3}, \frac{5}{6}, \frac{7}{12}$

5. Which of the following mixed numbers is represented by the letter Y in the number line shown?

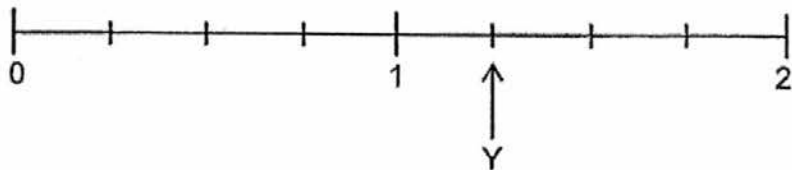

- 1)  $1\frac{1}{4}$
- 2)  $1\frac{3}{4}$
- 3)  $2\frac{1}{4}$
- 4)  $2\frac{3}{4}$

6. Write  $4\frac{7}{20}$  as a decimal.

1) 4.72

2) 4.7

3) 4.35

4) 4.035

7. Which number below is 1.4 less than 3.69?

1) 2.29

2) 3.55

3) 3.83

4) 5.09

8. Mrs Wee bought 60 pink balloons and 44 purple balloons. She packed 8 balloons into each bag. How many bags did she use to pack all the balloons?

1) 12

2) 13

3) 104

4) 912

9. Heather's age is between 15 and 30 years old. Her age is also a multiple of 4 and a factor of 56. Find Heather's age.

1) 16

2) 18

3) 24

4) 28

10. In a class, 18 pupils take the school bus. The remaining 12 pupils walk to school. What fraction of the pupils in the class walk to school?

1)  $\frac{1}{5}$

2)  $\frac{2}{5}$

3)  $\frac{3}{5}$

4)  $\frac{2}{3}$

11. There were 192 lollipops in a packet.  $\frac{2}{3}$  of the lollipops were divided equally among eight children. How many lollipops did each child receive?

1) 8

2) 16

3) 36

4) 72

12. Gabrielle had only the following five coins in her wallet.

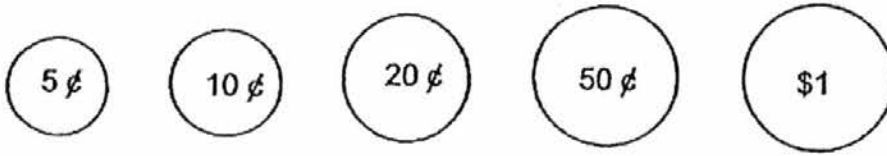

She took three coins from her wallet and dropped them into a donation tin. Which one of the following amount could be her total donation?

- 1) 30¢
  - 2) 75¢
  - 3) \$1.35
  - 4) \$2.05
13. In the figure shown, ABCD is a rectangle. Find  $\angle EDF$ .

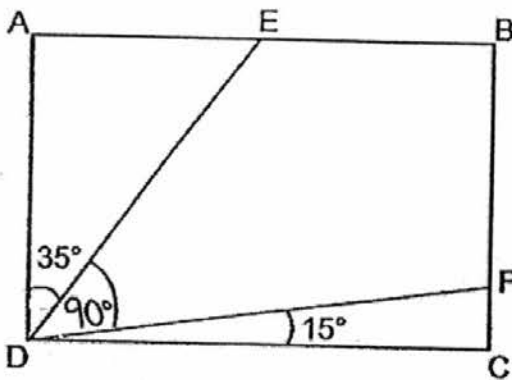

- 1) 40°
- 2) 50°
- 3) 55°
- 4) 75°

14. Which two roads are parallel to each other?

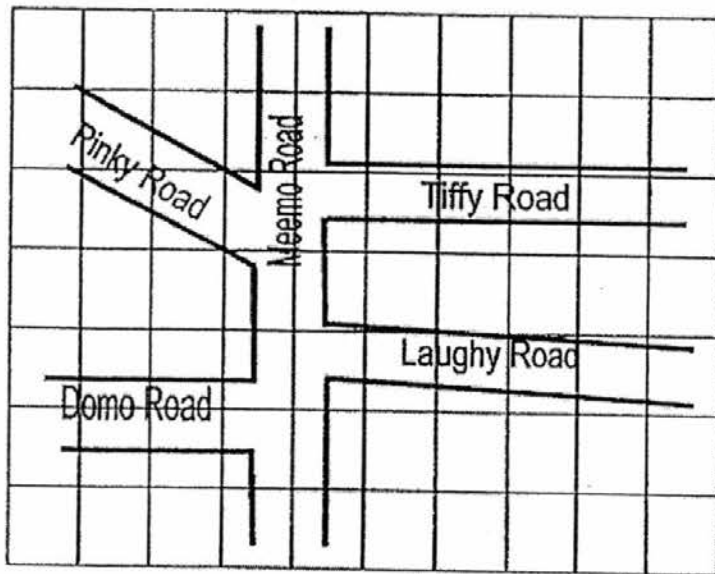

- 1) Domo Road and Pinky Road
- 2) Domo Road and Tiffy Road
- 3) Laughy Road and Tiffy Road
- 4) Meemo Road and Laughy Road

15. How many letters in the following word have at least 1 line of symmetry?

**H O N E S T**

- 1) 2
- 2) 3
- 3) 4
- 4) 5

16. A patch of carpet grass measuring 3 m by 2 m is planted in a rectangular plot of land. The carpet grass is surrounded by a wooden walkway. What is the area of the wooden walkway?

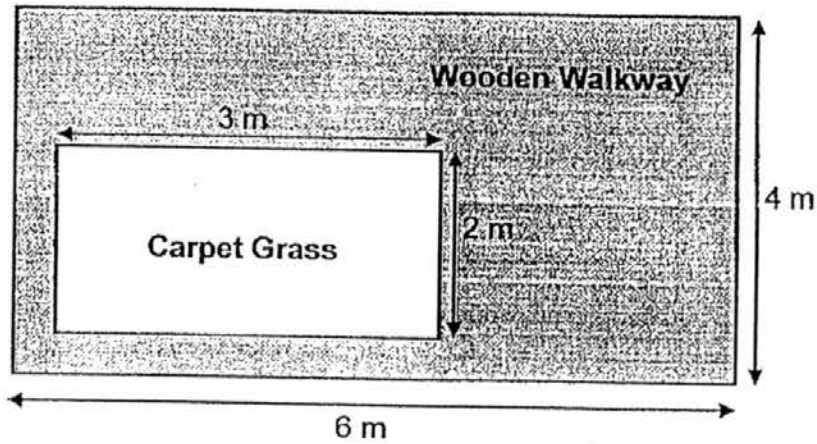

- 1)  $5 \text{ m}^2$   
2)  $6 \text{ m}^2$   
3)  $18 \text{ m}^2$   
4)  $24 \text{ m}^2$
17. There are 34 pupils in a class. The table below shows the number of cousins each pupil has.

Number of cousins each pupil has	0	1	2	3
Number of pupils	10	13	8	3

How many pupils in the class have more than 1 cousin?

- 1) 11  
2) 13  
3) 21  
4) 24



18. Shawn is facing the Police Station after making a  $\frac{3}{4}$  anti-clockwise turn. Where was he facing at first?

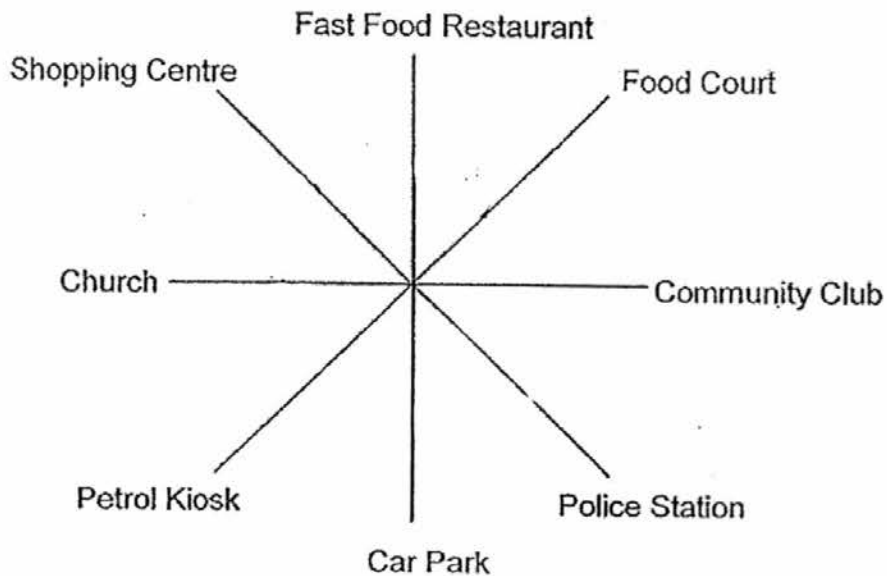

- 1) Church
  - 2) Food Court
  - 3) Petrol Kiosk
  - 4) Fast Food Restaurant
19. Kathy started doing her homework at 09 15. She used 2 h 45 min to complete her homework. Then she took a nap for 20 minutes before she had her lunch. At what time did she have her lunch?
- 1) 10 20
  - 2) 11 35
  - 3) 12 00
  - 4) 12 20

20. The figure below is made up of a square, CDEJ, and 2 identical rectangles, ABCK and EFGH. Find the area of the figure.

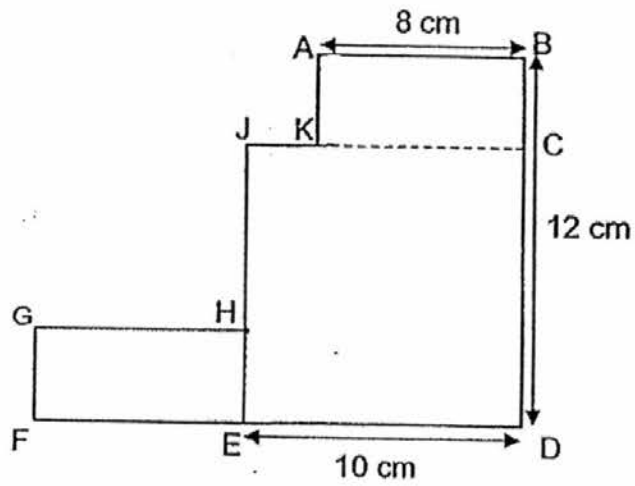

- 1)  $120 \text{ cm}^2$
- 2)  $132 \text{ cm}^2$
- 3)  $136 \text{ cm}^2$
- 4)  $196 \text{ cm}^2$

**\*\* END OF BOOKLET A \*\***

Name: \_\_\_\_\_ ( )

Class : Primary 4 \_\_\_\_\_

**CHIJ ST NICHOLAS GIRLS' SCHOOL (PRIMARY)**



**Primary 4 Mathematics**

**2016 Semestral Assessment Two**

**Booklet B**

**25 October 2016**

<b>Booklet A :</b>	<b>/ 40</b>
<b>Booklet B :</b>	<b>/ 60</b>
<b>Total :</b>	<b>/ 100</b>

\_\_\_\_\_  
Parent's/Guardian's Signature

**TOTAL TIME FOR BOOKLETS A AND B: 1 HOUR 45 MINUTES**

Do not turn over this page until you are told to do so.

Follow all instructions carefully.

Answer all questions.

This booklet consists of **16** printed pages including the cover page.

**Section B: (20 x 2 marks)**

**Write down your answers in the spaces provided. For questions which require units, give your answers in the units stated. Show all workings clearly.**

Do not  
write in  
this  
space.

21. Write nineteen thousand and forty-five in figures.

Ans : \_\_\_\_\_

22. What number is 10 more than 9999?

Ans : \_\_\_\_\_

23. Some factors of 63 are 1, 3, 7, and 63. What are the other two factors of 63?

Ans : \_\_\_\_\_ and \_\_\_\_\_

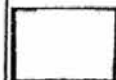

24. What is the value of  $\frac{2}{3} + \frac{11}{12}$ ?  
Express your answer as a mixed number.

Do not  
write  
in this  
space.

Ans : \_\_\_\_\_

25. Which two of the fractions below are smaller than  $\frac{1}{2}$ ?

$$\frac{1}{5} \quad , \quad \frac{4}{7} \quad , \quad \frac{5}{10} \quad , \quad \frac{4}{9}$$

Ans : \_\_\_\_\_ and \_\_\_\_\_

26. Write 5 hundredths in figures.

Ans : \_\_\_\_\_

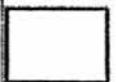

27. Round 17.56 to the nearest whole number.

Do not  
write  
in this  
space.

Ans : \_\_\_\_\_

28. In the figure, name the two angles that are greater than  $90^\circ$ .

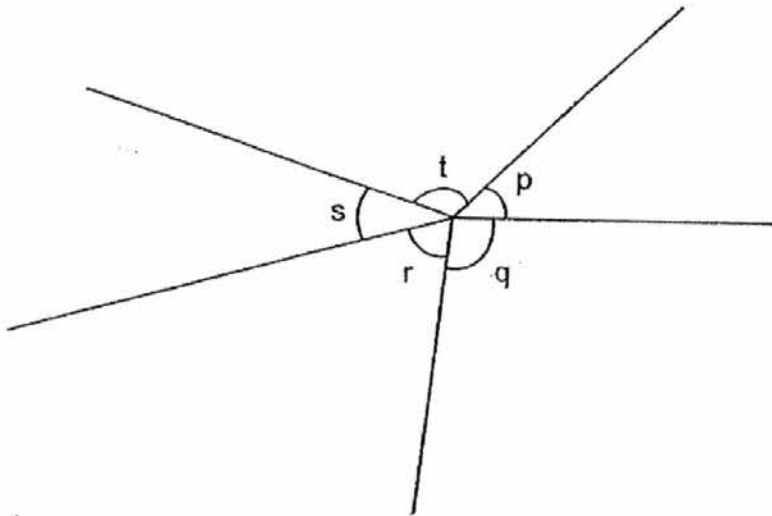

Ans :  $\angle$  \_\_\_\_\_ and  $\angle$  \_\_\_\_\_

29. What is the sum of the 6<sup>th</sup> multiple of 7 and the 8<sup>th</sup> multiple of 9?

Ans : \_\_\_\_\_



30. A chef had 105 kg of salmon. He used  $\frac{3}{7}$  of the salmon. How much salmon did he have left?

Do not  
write  
in this  
space.

Ans : \_\_\_\_\_ kg

31. Mrs Qia had 2.09 m of ribbon to make hair accessories. She bought another 1.5 m of ribbon. After making the hair accessories she needed, she had 1.7 m of ribbon left. How much ribbon did Mrs Qia use in total? Express your answer in cm.

Ans : \_\_\_\_\_ cm

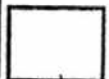

32. In the figure below, CE, FD and DG are straight lines.  $\angle FDG$  is three times of  $\angle GDE$ . What is the value of  $\angle GDE$ ?

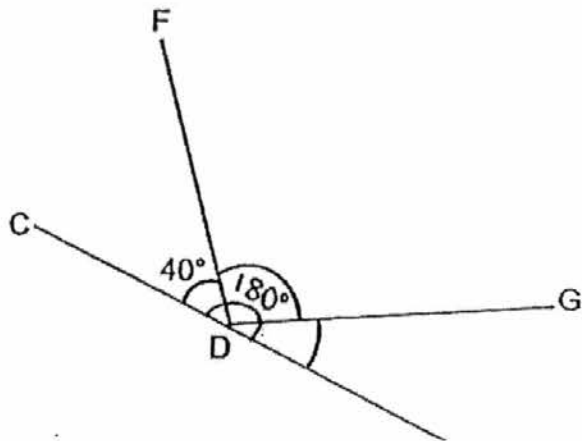

Ans : \_\_\_\_\_ °

33. Goldie reads the schedule shown below for the bus that leaves the bus interchange for the Singapore Zoo.

Leaves bus interchange	Arrives at Sentosa
8.30 a.m.	9.15 a.m.
8.45 a.m.	9.30 a.m.
9.20 a.m.	10.05 a.m.
9.45 a.m.	10.30 a.m.
10.30 a.m.	11.15 a.m.

Goldie wants to catch the bus that leaves at 8.30 a.m. but she is 25 minutes late. What is the earliest time that she can arrive at the Singapore Zoo by bus?

Ans : \_\_\_\_\_ a.m.

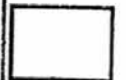

Do not write in this space.



34. The bar graph below shows the amount of money Elliot spent each month.

Do not  
write  
in this  
space.

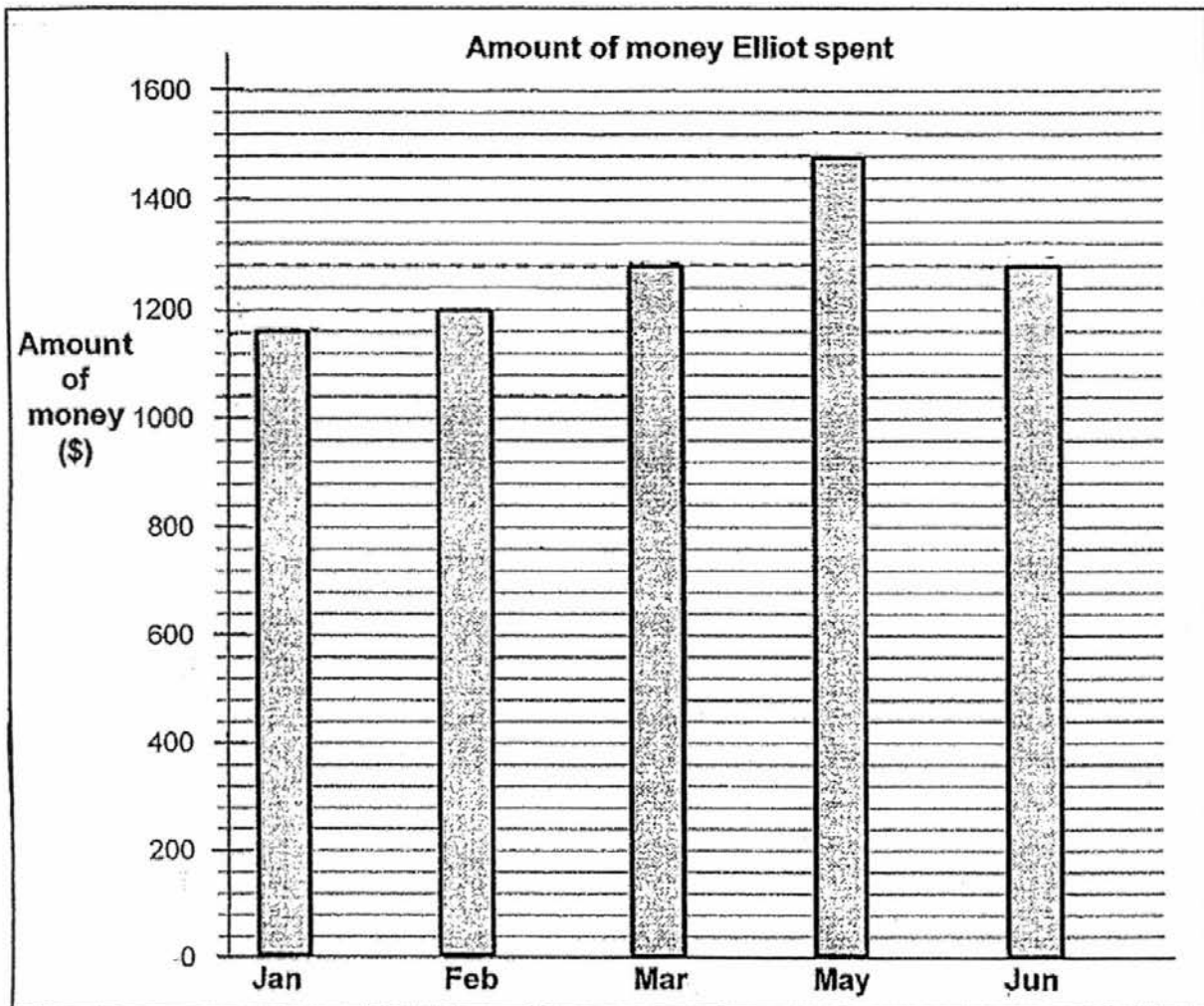

- (a) In which month did Elliot save the most amount of money?
- (b) How much money did he save in that month?

Ans : (a) \_\_\_\_\_

(b) \$ \_\_\_\_\_

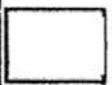

Use the line graph below to answer Questions 35 and 36.  
The line graph shows the number of apples a class of pupils had eaten in a day.

Do not  
write  
in this  
space.

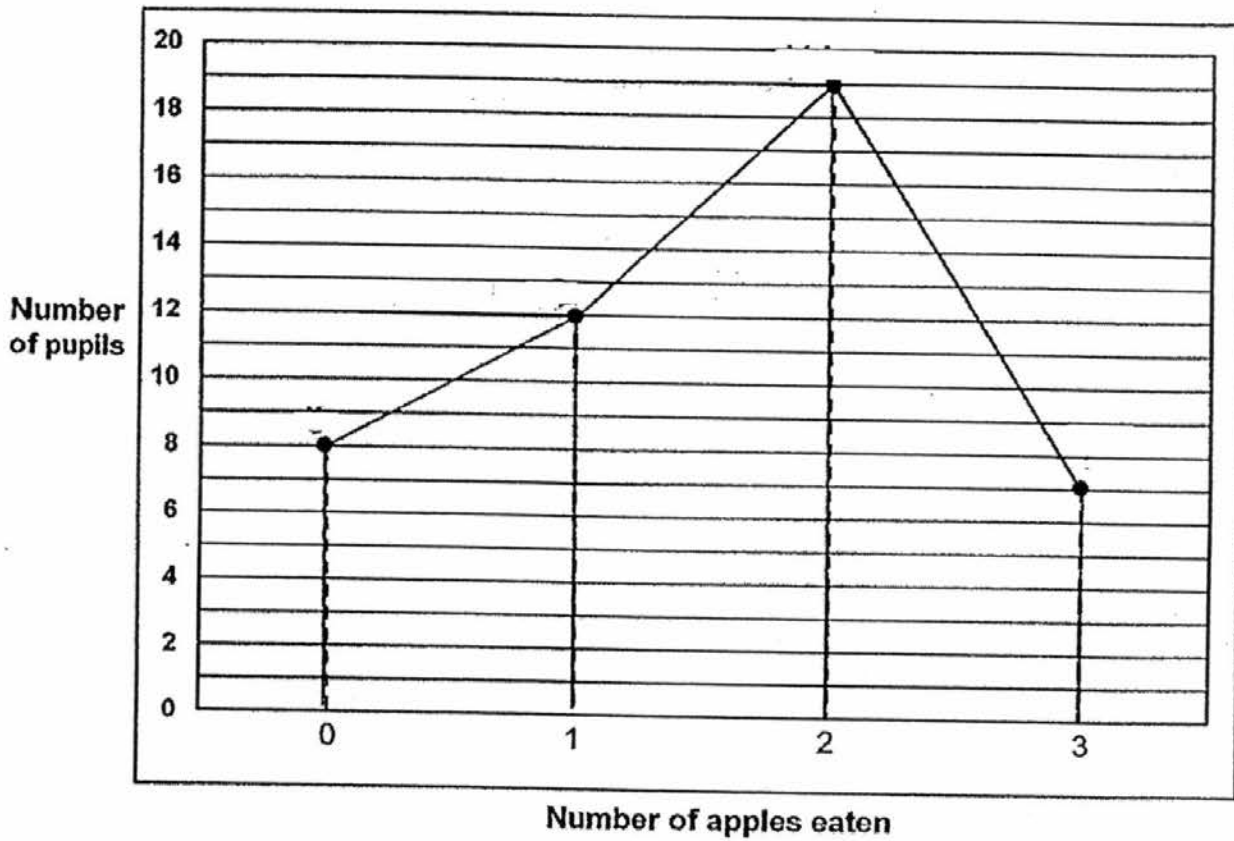

35. How many pupils were there altogether?

Ans : \_\_\_\_\_

36. How many apples were eaten altogether in a day?

Ans : \_\_\_\_\_

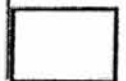

37. Avla jogs at the stadium once every 3 days. Bowie jogs at the same stadium once every 5 days. If they were to first meet at the stadium on a Wednesday, when would be the next day that they would meet again?

Do not write in this space.

Ans : \_\_\_\_\_

38. The total mass of a basket and a durian was 10.14 kg. After a watermelon was put into the basket, the total mass of the basket, durian and watermelon became 20 kg. The watermelon was twice as heavy as the durian. What was the mass of the durian?

Ans : \_\_\_\_\_ kg

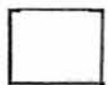

39. The opening hours of Pawprint Pet's Café are shown below. How long is the café open in a week?

Monday	Closed
Tuesday to Friday	12 p.m. to 9 p.m.
Saturday and Sunday	11 a.m. to 10 p.m.

Ans : \_\_\_\_\_ h

40. The table below shows the number of stars Mrs Cheong awarded to her pupils for getting full score in their topical tests.

Number of stars	Number of pupils
0	7
1	3
2	5
3	10
4	9
5	9

Mrs Cheong would award the pupils who had obtained at least 2 stars with a popsicle each. Each popsicle cost 80¢ each. How much would she have to pay in all?

Ans : \$ \_\_\_\_\_

Do not  
write  
in this  
space

**Section C: (20 marks)**

Show your working clearly and write your answers in the spaces provided. The number of marks available is shown in brackets [ ] at the end of each question or part-question.  
(20 marks)

Do not write in this space.

41. Study the pattern below. Each figure is made up of identical circles.
- (a) How many circles are used to form Figure 4?
- (b) How many more circles are used to form Figure 7 than Figure 4?

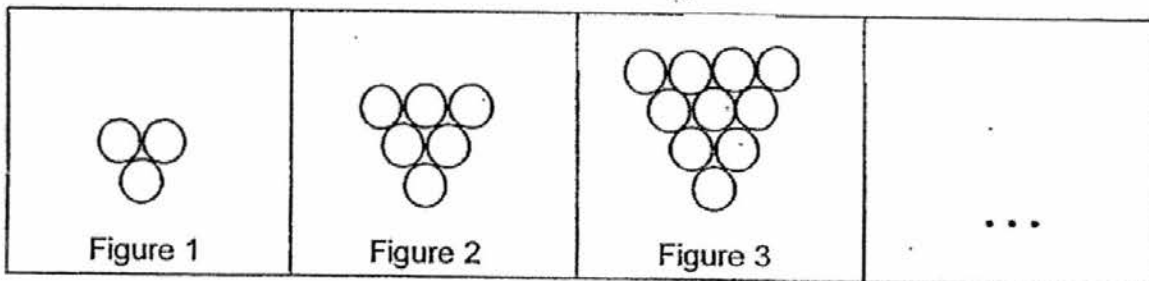

Ans : (a) \_\_\_\_\_ [1]

(b) \_\_\_\_\_ [2]

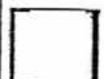

42. Darlene spent  $\frac{1}{9}$  of her money on a wall clock and \$124 on a table lamp. She had \$92 left. How much did she spend on the wall clock?

Do not  
write  
in this  
space.

Ans : \_\_\_\_\_ [3]

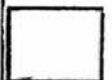

43. The table shows the charges for developing film at Look Good Photoshop.

Do not  
write  
in this  
space

Service	Charges
Developing	\$5 per roll of film
Printing	?

Ming Ming sent a roll of film for developing and 7 photographs for printing. She paid the cashier \$50 and received a change of \$39.82. How much did the shop charge for printing each photograph?

Ans : \_\_\_\_\_ [ 3 ]

44. Figure X is made up of identical squares. It has a total area of  $320 \text{ cm}^2$ .  
 Figure Y shows the re-arrangement of the same squares used in Figure X.  
 Find the perimeter of Figure Y.

Do not write in this space.

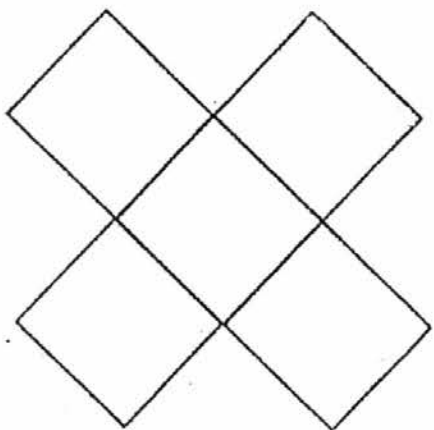

Figure X

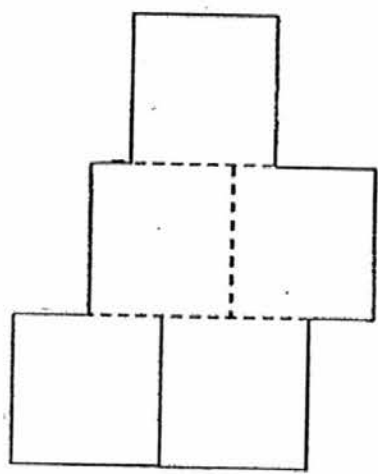

Figure Y

Ans : \_\_\_\_\_ [3]





45. What is the area of the figure below?

Do not write in this space.

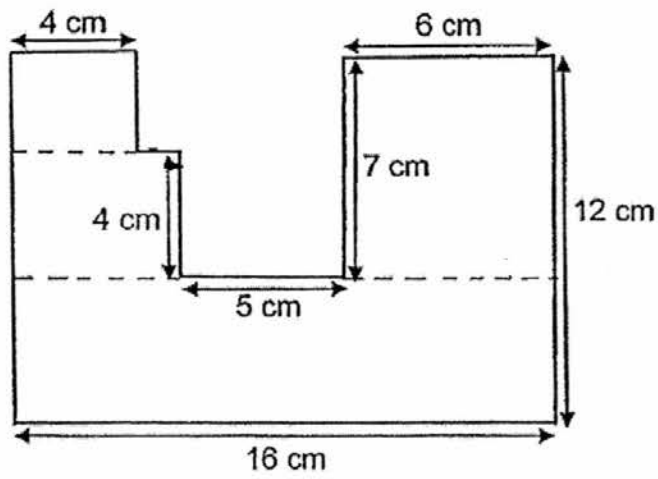

Ans : \_\_\_\_\_ [ 4 ]

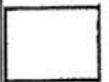

46. At a stadium, there were an equal number of men and women. 79 men and 599 women left the stadium. In the end, there were 6 times as many men as women who remained behind. How many women were there at first?

Do not write in this space.

Ans : \_\_\_\_\_ [4]

**\*\*END OF PAPER\*\***

EXAM PAPER 2016 (P4)

SCHOOL : CHIJ

SUBJECT : MATHEMATICS

TERM : SA2

Q1	Q2	Q3	Q4	Q5	Q6	Q7	Q8	Q9	Q10
4	2	4	2	1	3	1	2	4	2
Q11	Q12	Q13	Q14	Q15	Q16	Q17	Q18	Q19	Q20
2	2	1	2	3	3	1	2	4	2

21)19045      22)10009      23)21 and 9      24) $1\frac{7}{12}$       25) $\frac{1}{5}$  and  $\frac{4}{9}$

26)0.05      27)18      28) + and q      29)114

30) $105 \div 7 = 15$

$$15 \times 3 = 45$$

$$105 - 45 = 60 \text{ kg}$$

31) $2.09 + 1.5 = 3.59$

$$3.59 - 1.7 = 1.89 \text{ m}$$

32) $180 - 40 = 140$

$$140 \div 4 = 35^\circ$$

33)10.05 a.m.

34)a)May

b)\$1480

35) $12 + 8 = 20$

$20 + 19 = 39$

$39 + 7 = 46$

36) $12 \times 1 = 12$

$19 \times 2 = 38$

$7 \times 3 = 21$

$12 + 38 = 50$

$50 + 21 = 71$

37)A : 3, 6, 9, 12, 15

B : 5, 10, 15

15 days after Wednesday is Thursday

38) $20 - 10.14 = 9.86$

$9.86 \div 2 = 4.93\text{kg}$

39) $9\text{h} \times 4 = 36\text{h}$

$11\text{h} \times 2 = 22\text{h}$

$36 + 22 = 58\text{ h}$

40) $10 + 5 = 15$

$15 + 9 = 24$

$24 + 9 = 33$

$80\text{c} = \$0.80$

$0.80 \times 33 = \$26.40$

41)a)  $10 + 5 = 15$

15 circles are used to form Figure 4.

b)  $15 + 6 = 21$

$21 + 7 = 28$

$28 + 8 = 36$

$36 - 15 = 21$

21 more circles are used to form Figure 7 than Figure 4.

42)  $124 + 92 = 216$

$9/9 - 1/9 = 8/9$

$216 \div 8 = 27$

She spent \$27 on the wall clock.

43)  $50 - 39.82 = 10.18$

$10.18 - 5 = 5.18$

$5.18 \div 7 = 0.74$

The shop charged \$0.74 for printing each photograph.

44)  $320 \div 5 = 64$

$64 = 8 \times 8$

$8 \times 11 = 88$

The perimeter of Figure Y is 88cm

$$45) 7 - 4 = 3$$

$$4 \times 3 = 12$$

$$16 - 6 = 10$$

$$10 - 5 = 5$$

$$5 \times 4 = 20$$

$$12 - 7 = 5$$

$$16 \times 5 = 80$$

$$6 \times 7 = 42$$

$$12 + 20 = 32$$

$$32 + 80 = 112$$

$$112 + 42 = 154$$

The area of the figure below is 154cm<sup>2</sup>.

$$46) 599 - 79 = 520$$

$$520 \div 5 = 104$$

$$104 + 599 = 703$$

There were 703 women at first.