



Maha Bodhi School
2015 Semestral Assessment 2
Primary 4
Mathematics
Booklet A

Name : _____ ()

Class : Primary 4 _____

Date : 30 October 2015

Total duration for Booklets A and B: 1 h 45 min

INSTRUCTIONS TO CANDIDATES:

1. Do not turn over this page until you are told to do so.
2. Follow all instructions carefully.
3. Answer all questions.
4. Shade your answers in the Optical Mark Sheet provided.

This booklet consists of 8 printed pages.

Section A (40 marks)

Questions 1 to 20 carry 2 marks each.

For each question, four options are given. One of them is the correct answer.

Make your choice (1, 2, 3 or 4). Shade the oval (1, 2, 3 or 4) on the Optical Mark Sheet.

1. 78 thousands and 3 tens is the same as _____.

- (1) 783
- (2) 7830
- (3) 78 003
- (4) 78 030

2. Which one of the following numbers when rounded off to the nearest ten becomes 42 600?

- (1) 42 544
- (2) 42 596
- (3) 42 605
- (4) 42 654

3. $8\frac{4}{5} = \frac{\square}{5}$

- (1) 32
- (2) 36
- (3) 40
- (4) 44

4. Find the value of $\frac{7}{9} - \frac{1}{3}$.

- (1) $\frac{1}{3}$
- (2) $\frac{2}{3}$
- (3) $\frac{4}{9}$
- (4) $\frac{8}{9}$

5. Express 0.08 as a fraction in its simplest form.

(1) $\frac{1}{8}$

(2) $\frac{2}{25}$

(3) $\frac{1}{4}$

(4) $\frac{4}{5}$

6. How many of the marked angles in the shaded figure are smaller than one right angle?

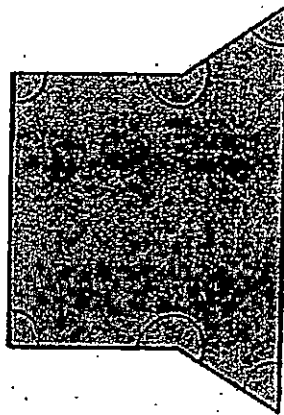

(1) 6

(2) 2

(3) 3

(4) 4

7. How many common factors of 18 and 24 are there?

(1) 5

(2) 2

(3) 3

(4) 4

8. A string 5.8 m long is used to make 4 similar ribbons.
Find the total length needed to make 6 such ribbons.

- (1) 8.4 m
- (2) 8.7 m
- (3) 11.8 m
- (4) 18.7 m

9. In the figure below, ABCD is a rectangle.
 $\angle x$ is twice the size of $\angle y$. Find $\angle x$.

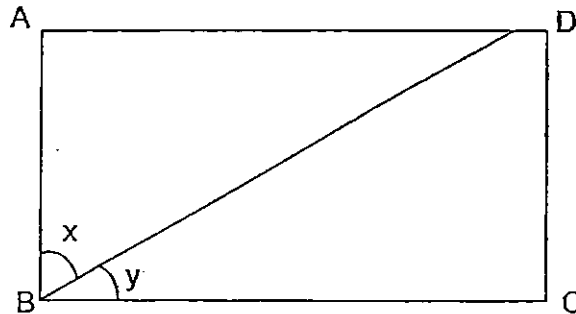

- (1) 30°
- (2) 45°
- (3) 60°
- (4) 75°

10. Which one of the shapes below can be tessellated?



Shape A



Shape B



Shape C

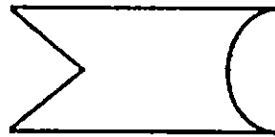

Shape D

- (1) A
- (2) B
- (3) C
- (4) D

11. The rectangle below, not drawn to scale, has a perimeter of 72 cm.

Its length is 3 times as long as the breadth.

Find the length of the rectangle.

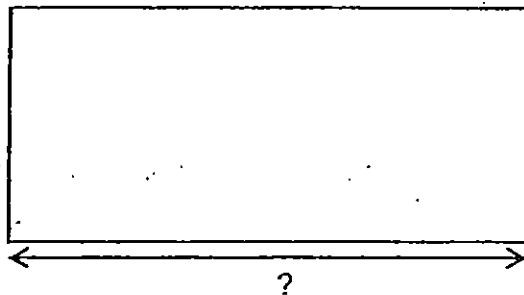

- (1) 9 cm
- (2) 18 cm
- (3) 24 cm
- (4) 27 cm

12. Ahmad, Gary, Ravinder and Zhi Ming had a race and their timings are recorded below.

Name	Timing (s)
Ahmad	32
Gary	47
Ravinder	29
Zhi Ming	53

Who came in second in the race?

- (1) Ahmad
- (2) Gary
- (3) Ravinder
- (4) Zhi Ming

13. Tom went to watch a movie which started at 11.45 a.m.
He took 30 min to reach home after the movie. The movie was 2 h 15 min long.
What time did he reach home?

- (1) 02 00
- (2) 02 30
- (3) 14 00
- (4) 14 30

Mr Tan's water tank has a crack and water is leaking. The graph below shows the volume of water left in Mr Tan's tank from February to June. Use the graph to answer questions 14 and 15.

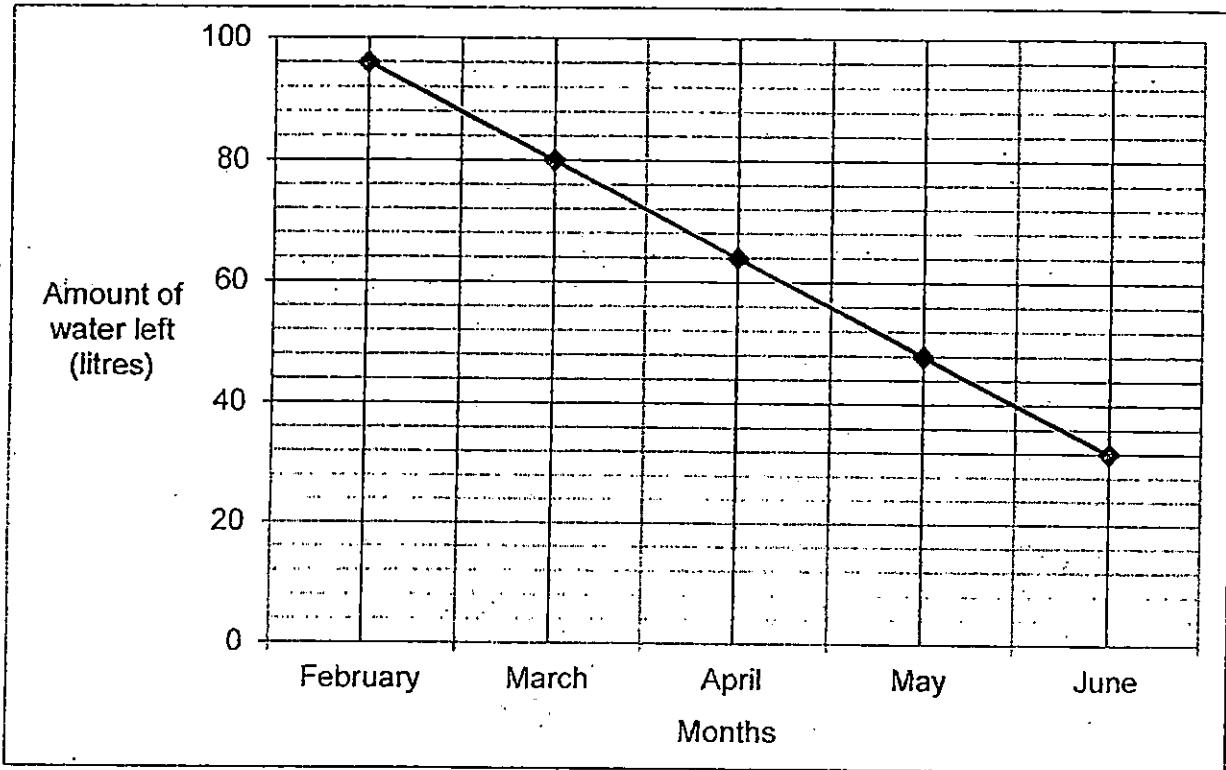

14. How much water was left in the tank at the end of June?

- (1) 26 l
- (2) 28 l
- (3) 32 l
- (4) 36 l

15. By the end of which month would there be no water left in Mr Tan's tank?

- (1) July
- (2) August
- (3) September
- (4) October

16. Sarah is 10 years old and her father is 38 years old. How old will Sarah be when her father is thrice as old as her?

- (1) 14
- (2) 28
- (3) 30
- (4) 48

17. James and Amelie shared some beads. James took $\frac{3}{7}$ of the beads.

After James lost 14 beads, Amelie had twice as many beads as James.

How many beads did Amelie have?

- (1) 28
- (2) 42
- (3) 56
- (4) 98

18. A rectangular piece of paper, not drawn to scale, is folded as shown below.

What is the area of the piece of paper?

- (1) 450 cm^2
- (2) 600 cm^2
- (3) 2000 cm^2
- (4) 2200 cm^2

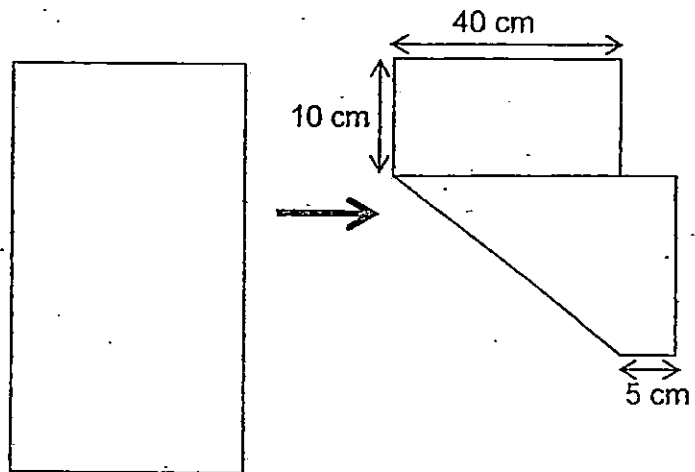

19. The table below shows the calendar for January 2016.

January 2016						
Sunday	Monday	Tuesday	Wednesday	Thursday	Friday	Saturday
					1	2
3	4	5	6	7	8	9
10	11	12	13	14	15	16
17	18	19	20	21	22	23
24	25	26	27	28	29	30
31						

What day is 26 February 2016?

- (1) Monday
- (2) Tuesday
- (3) Friday
- (4) Saturday

20. The table shows the number of pupils who wear spectacles in classes 4A to 4C.
How many girls in 4A wear spectacles?

	4A	4B	4C	Total
Boys		12		
Girls			8	24
Total	14	22		56

- (1) 8
- (2) 7
- (3) 3
- (4) 6



Maha Bodhi School
2015 Semestral Assessment 2
Primary 4
Mathematics
Booklet B

Name : _____ ()

Class : Primary 4 _____

Date : 30 October 2015

Total duration for Booklets A and B: 1 h 45 min

INSTRUCTIONS TO CANDIDATES:

1. Do not turn over this page until you are told to do-so.
2. Follow all instructions carefully.
3. Answer all questions.
4. Write your answers in this booklet.

Booklet	Marks Obtained	Max Marks
A		40
B		60
Total		100

Parent's signature: _____

This booklet consists of 10 printed pages.

Section B (40 marks)

Questions 21 to 40 carry 2 marks each.

Write your answers in the spaces provided, giving the answers in the units stated.

Show your working clearly in the space provided below each question.

Marks will be awarded for correct method shown.

21. Write three thousand and eleven in numerals.

Ans: _____

22. $1370 \times 5 =$ _____

Ans: _____

23. What number is 10 more than 2195?

Ans: _____

24. Write $\frac{11}{6}$ as a mixed number in its simplest form.

Ans: _____

25. $\frac{5}{8} + \frac{1}{4} =$ _____

Ans: _____

26. Arrange the following numbers from the smallest to the greatest.

$$\frac{4}{5}, 0.805, 0.085$$

Ans: _____
smallest

27. Express $\frac{77}{100}$ as a decimal.

Ans: _____

28. $14.65 + 0.39 =$ _____

Ans: _____

29. Measure and write down the size of $\angle x$.

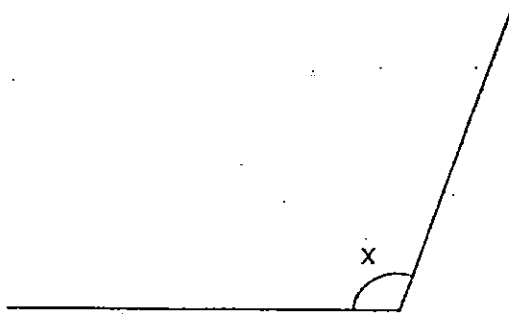

Ans: _____

30. What are the first two common multiples of 6 and 8?

Ans: _____ and _____

31.

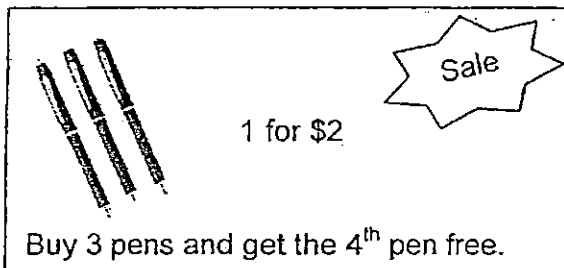

1 for \$2

Sale

Buy 3 pens and get the 4th pen free.

Siti spent \$48 on the pens.

How many pens did she buy?

Ans: _____ pens

32. The mass of one papaya and 7 oranges is 5.8 kg.

The papaya is 2.68 kg heavier than each orange. Find the mass of one orange.

Ans: _____ kg

33. Complete the figure so that the dotted line is a line of symmetry of the figure.

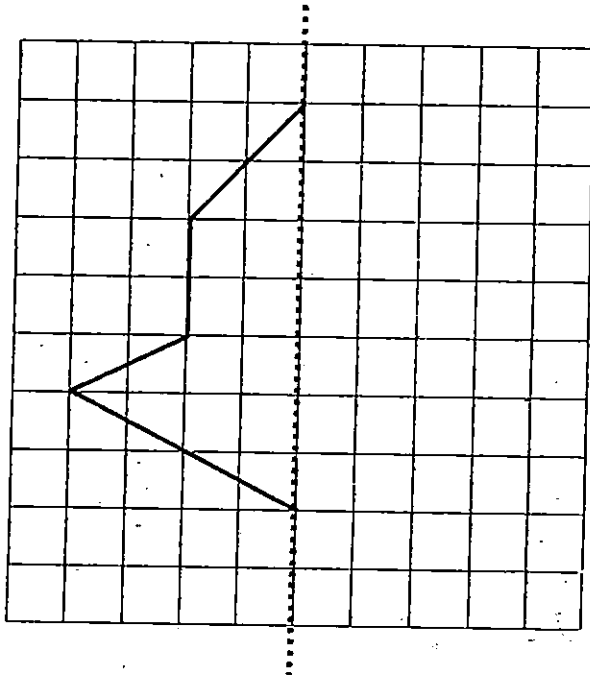

34. Using the square grid, draw a line that is parallel to line AB.

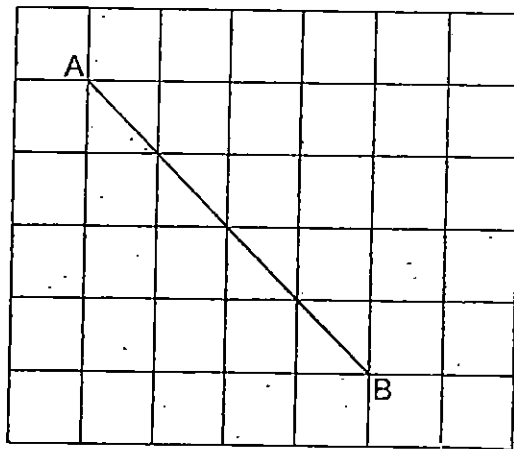

35. Melvin has 435 stamps and Julia has 389 stamps.
 After Melvin gave Julia some stamps, both of them have the same number of stamps.
 How many stamps did Melvin give Julia?

Ans: _____ stamps

36. Two rectangles are each divided into equal parts as shown in Figures A and B below.
 The shaded parts represent a fraction for each figure.

Figure A

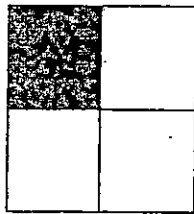
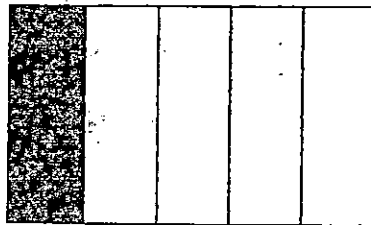
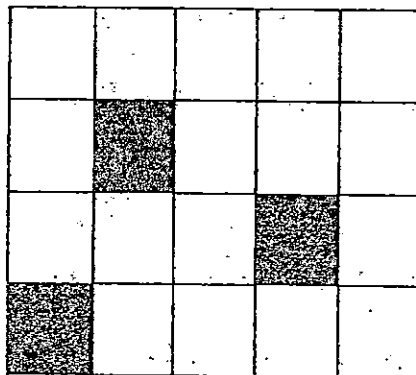

Figure B



How many more rectangles must be shaded in Figure C below to show the sum of fractions shaded in Figure A and Figure B?

Figure C



Ans: _____ rectangles

37. Look at the diagram below. It is made up of 56 squares.

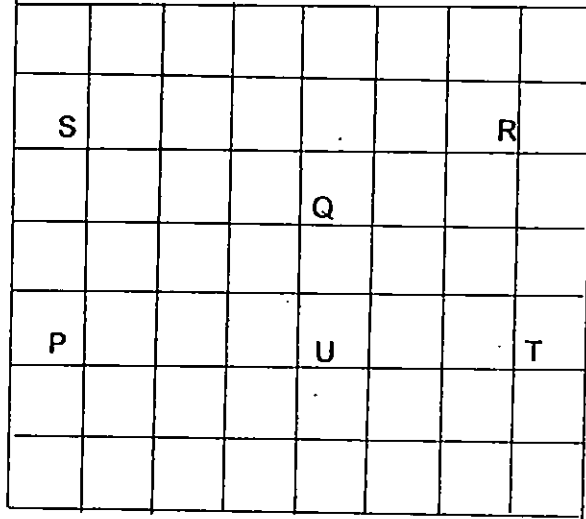

Chan Hoo walks from point Q to point U and makes a $\frac{1}{4}$ -turn to his left.

He takes 3 steps forward before making another $\frac{1}{4}$ -turn to his left.

His final destination is 3 steps forward.

Which point is his final destination? (Note: 1 step is equal to 1 square.)

Ans: Point _____

38. The figure below is made up of 6 identical rectangles with no overlapping parts. Each rectangle has a perimeter of 12 cm. Find the perimeter of the figure.

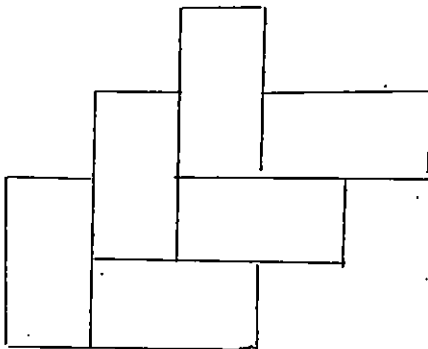

Ans: _____ cm

39. Paul has a bell that rings every 4 minutes. Lucy has a bell that rings every 7 minutes. The 2 bells ring together at 11 a.m. What time will the 2 bells ring together again?

Ans: _____ a.m.

40. A toy costs \$12. However, Wen Hao has no money and starts saving for it. He saves \$1 on the first day. Each day, he saved 20 cents more than the day before. If Wen Hao continues to save money every day, what is the least number of days he will need to save to buy the toy?

Day	Amount saved per day
1	\$1
2	\$1.20
3	\$1.40
:	:

Ans: _____ days

Section C (20 marks)

Questions 41 to 45 carry 4 marks each.

Show your working clearly in the space below each question.

For each question, write your number sentences and final statement.

41. Ben, Cathy and Daniel had 1080 cards altogether.

Ben had twice as many cards as Cathy.

Daniel had 40 cards less than Cathy.

How many cards did Daniel have?

42. Amanda needs $\frac{4}{5}$ m of cloth to sew a skirt.

She needs 6 m of cloth to sew 2 skirts and a dress.

How much cloth will she need to sew one dress?

(Give your answer in m.)

43. A bag of beans and a packet of sugar have a mass of 4.25 kg.
3 similar bags of beans and 2 similar packets of sugar weigh 11 kg.
What is the mass of 1 bag of beans?

44. Shaun cuts out one square at the corner of a rectangular piece of paper as shown.
What is the area of the remaining piece of paper?

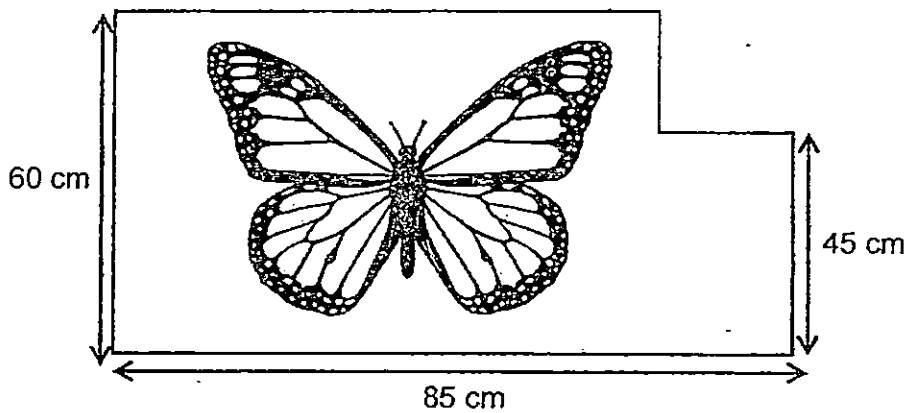

45. Mr Ho wants to buy the same type of files.
If he buys 6 files, he will have \$3 left.
If he buys 8 files, he will be short of \$5.50.
How much do 6 files cost?



14

--End of Paper--

Remember to check your work! Every mark counts.

This is the property of Maha Bodhi School.
No part of this should be duplicated without the permission of Maha Bodhi School.



EXAM PAPER 2015

LEVEL : PRIMARY 4

SCHOOL : MAHA BODHI SCHOOL

SUBJECT : MATHEMATICS

TERM : SA2

Q1	Q2	Q3	Q4	Q5	Q6	Q7	Q8	Q9	Q10
4	2	4	3	2	2	4	2	3	1
Q11	Q12	Q13	Q14	Q15	Q16	Q17	Q18	Q19	Q20
4	1	4	3	2	1	3	4	3	4

- Q21. 3011 Q22. 6850 Q23. 2205 Q24. 1 $\frac{5}{6}$ Q25. $\frac{7}{8}$
 Q26. 0.085 (smallest), $\frac{1}{5}$, 0.805 Q27. 0.77 Q28. 15.04
 Q29. 110° Q30. 24 and 48 Q31. 32 pens Q32. 0.39 \rightarrow $3.12 \div 8 = 0.39$

Q33. SEE PICTURE

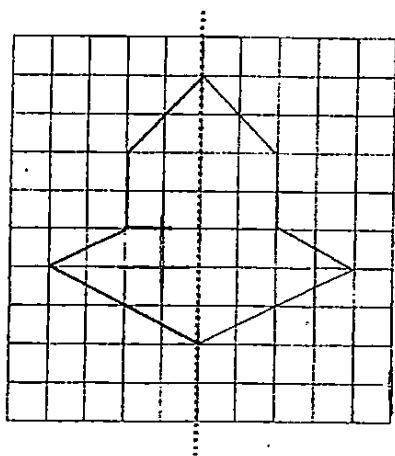

Q34. SEE PICTURE

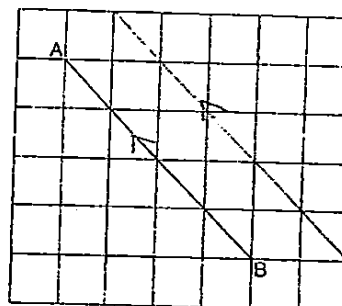

Q35. 23 stamps $\rightarrow 435 + 389 = 824$, $824 \div 2 = 412$, $435 - 412 = 23$

Q36. 6 rectangles Q37. Point R

Q38. 36cm
 1 length = 2 breadth
 $6u = 12\text{cm}$, breadth = $12 \div 6 = 2\text{cm}$
 Length = 4cm, $18 \times 2 = 36$

Q39. 11.28a.m $\rightarrow 4, 8, 12, 16, 20, 24, 28, 7, 14, 21, 28$

Q40. 8 days

Day	Amount saved per day	Total
1	\$1	\$1
2	\$1.20	\$2.20
3	\$1.40	\$3.60
4	\$1.60	\$5.2
5	\$1.80	\$7
6	\$2.00	\$9
7	\$2.20	\$11.20
8	\$2.40	\$13.60

Q41. $240 \rightarrow$ cards $1080 + 40 = 1120$, $1120 \div 4 = 280$, $280 - 40 = 240$

Q42. 4.4m of cloth

$\frac{1}{2}m \times 100 = 80cm$, $80cm + 80cm = 1m60cm$, $6m - 1m60cm = 4.4m$

Q43. 2.50kg

Let B be the mass of 1 bag of beans

Let S be the mass of 1 packet of sugar

$4.25kg \times 2 = 8.50kg$, $11kg - 8.50kg = 2.50kg$

Q44. $4875cm^2$

$60cm - 45cm = 15cm$

$15cm \times 15cm = 225cm^2$

$60cm \times 86cm = 5100cm^2$

$5100cm^2 - 225cm^2 = 4875cm^2$

Q45. \$2.25

$5.50 + 3.80 = 8.50$, $8.50 \div 2 = 4.25$, $4.25 \times 6 = 25.50$