

SINGAPORE CHINESE GIRLS' SCHOOL  
SECOND SEMESTRAL ASSESSMENT 2014  
PRIMARY 4  
MATHEMATICS  
BOOKLET B

Name : \_\_\_\_\_ (      )

Class : Primary 4 SY/C/G/SE/P

		Marks attained	Max Mark
Booklet A	Section A		30
Booklet B	Section B		40
	Section C		30
Total			100

Parent's Signature

There are 28 questions in this booklet.  
SECTION B and C

**Total Time : 1 h 45 min (Booklet A and B)**

**INSTRUCTIONS TO CANDIDATES**

DO NOT OPEN THIS BOOKLET UNTIL YOU ARE TOLD TO DO SO.  
FOLLOW ALL INSTRUCTIONS CAREFULLY.  
ANSWER ALL QUESTIONS.

**This question paper consists of 13 printed pages. (Inclusive of cover page)**

**Section B: ( 40 marks )**

Questions 16 to 35 carry 2 marks each. Write your answers in the spaces provided. For questions which require units, give your answers in the units stated.

Do not write  
In this column

16.  $37\,208 = 30\,000 + 7000 + \underline{\hspace{2cm}} + 8$

What is the missing number?

Ans:                     

17. Fill in the blank with the correct number in the number pattern below.

$475, 450, 425, \underline{\hspace{2cm}}, 375$

Ans:                     

18. Express  $\frac{9}{12}$  in its simplest form.

Ans:                     

19. Write  $\frac{16}{5}$  as a mixed number in its simplest form.

Ans:                     

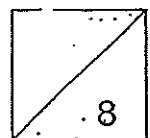

20. Find the value of  $1 - \frac{3}{4} - \frac{1}{8}$  ?

Do not write  
in this column

Ans: \_\_\_\_\_

21. Express 0.7 as a fraction.

Ans: \_\_\_\_\_

22. Write the decimal represented by A?

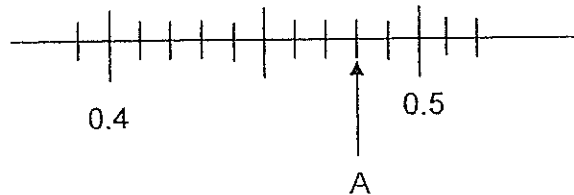

Ans: \_\_\_\_\_

23. Round off 27.69 to the nearest whole number.

Ans: \_\_\_\_\_

24. Arrange the following numbers in order from the greatest to the smallest.

0.076 , 0.607 , 0.706

Ans: \_\_\_\_\_ , \_\_\_\_\_ , \_\_\_\_\_  
(greatest) (smallest)

Do not write  
in this column

25. In a cinema,  $\frac{1}{2}$  of them were children,  $\frac{1}{6}$  of them were men and the rest were women. What fraction of the people in the cinema were women? Express your answer in the simplest form.

Ans: \_\_\_\_\_

26. Lynette mixed  $\frac{1}{3}$  kg of sugar with  $\frac{5}{6}$  kg of flour. What was the mass of the mixture? Express your answer in the simplest form.

Ans: \_\_\_\_\_ kg

27. The figure below is made up of 2 rectangles. Find the perimeter of the whole figure.

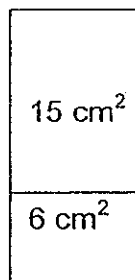

Ans: \_\_\_\_\_ cm

28. The mass of an armchair is  $\frac{1}{4}$  the mass of a sofa. The sofa is 29.4 kg heavier than the armchair. What is the total mass of the armchair and the sofa?

Ans: \_\_\_\_\_ kg

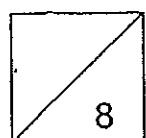

29. 7 lamp posts are placed in equal distance along the length of one side of a field. If the distance between 2 lamp posts is 1.18 m, what is the length of the field? (Round off your answer to 1 decimal place.)

Do not write  
in this column

Ans: \_\_\_\_\_ m

30. Draw a line perpendicular to MN passing through point X.

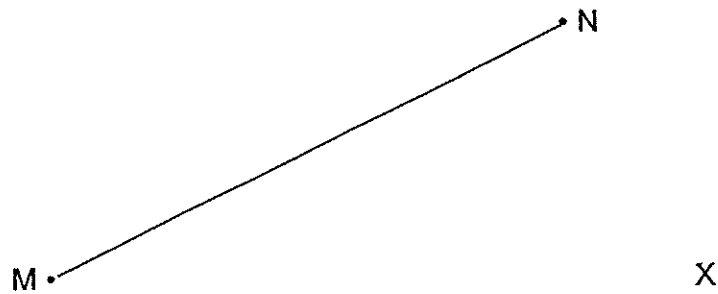

31. Complete the diagram below to form a symmetric figure. The dotted line is the line of symmetry.

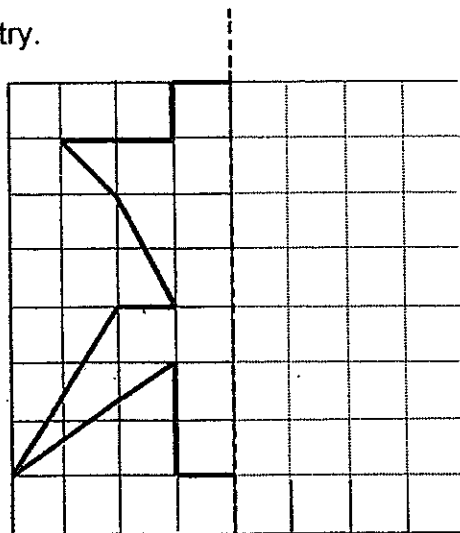

32. The pattern in the box shows part of a tessellation.  
Draw 4 more unit shapes in the space provided.

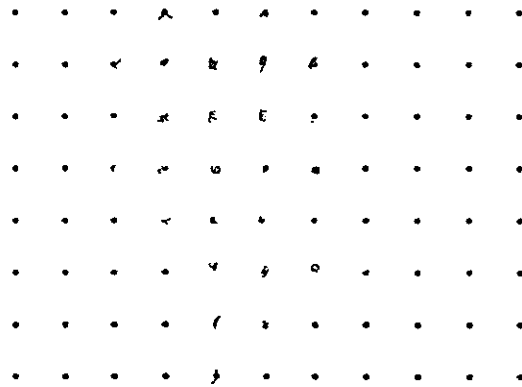

Do not write  
in this column

33. The following line graph shows the number of people at a carnival from 10 a.m. to 4 p.m.

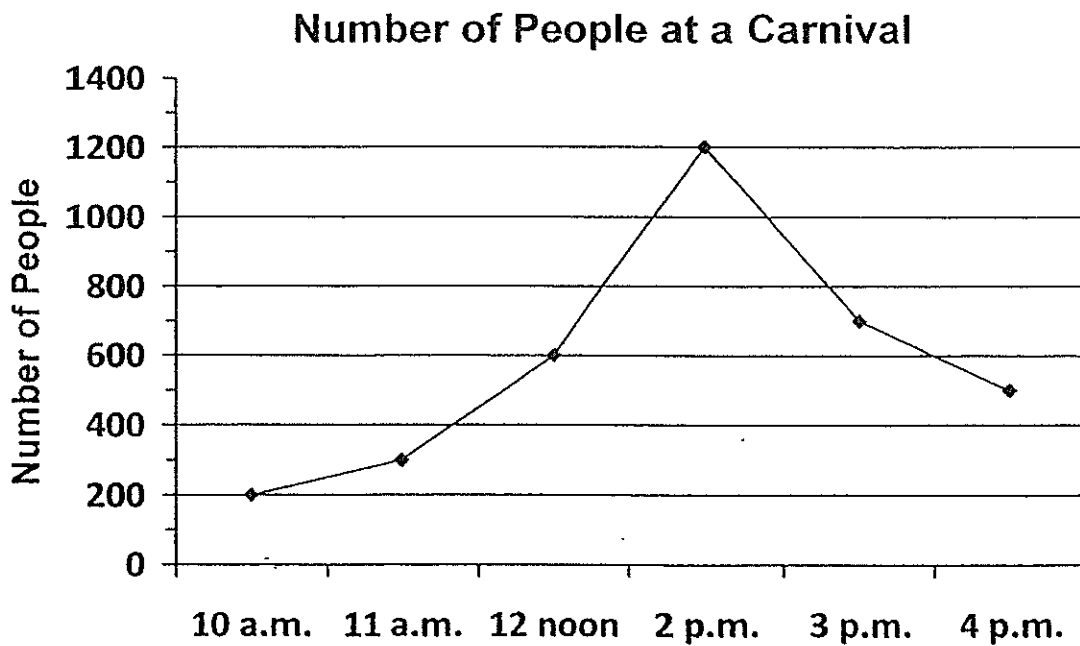

Which time of the day did the total number of people start to decrease?

Ans: \_\_\_\_\_

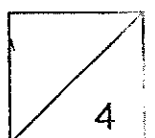

34. The bar graph below shows the number of pets per family participating in a pet competition.

Do not write  
in this column

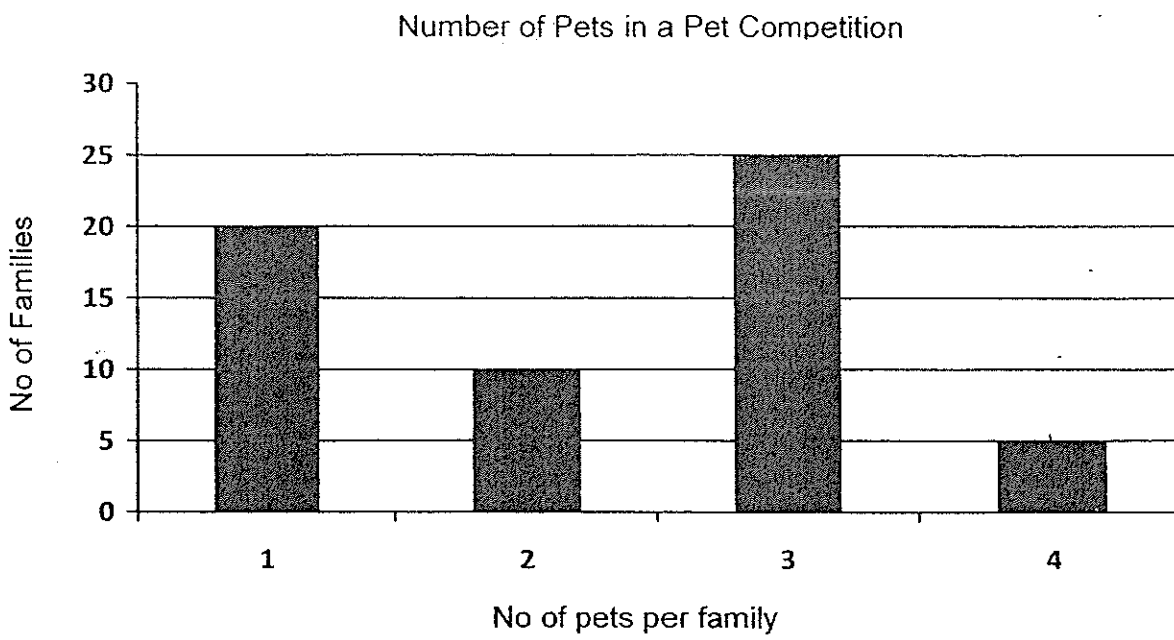

How many families have at least 2 pets?

Ans: \_\_\_\_\_

35. Three identical squares overlap each other as shown below. Find the area of the figure.

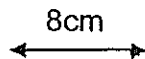

Ans: \_\_\_\_\_  $\text{cm}^2$

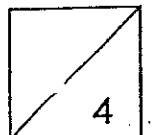

**Section C: (30 marks)**

For questions 36 to 43, show your working clearly in the space provided for each question and write your answer in the space provided. The marks allotted is shown in brackets [ ] at the end of each question or part-question

Do not write  
in this column

36. Renee, Azimah and Mei Ching ran a total distance of 1530 m.

Renee ran thrice the distance as far as Azimah.

Mei Ching only ran half the distance as Azimah.

How much farther did Renee run than Azimah?

(Express your answer in km.)

Ans: \_\_\_\_\_ [4]

37. Bottle A had twice as much apple juice as Bottle B. After Yuki drank 40 ml of the apple juice from Bottle B, Bottle A had 6 times as much apple juice as Bottle B. How much apple juice was there in Bottle A?

Ans: \_\_\_\_\_ [3]

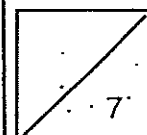



38. Mr Tan, Mr Yap and Mr Lim sold apples during a charity event.  
Mr Tan sold 4 times as many apples as Mr Lim.  
Mr Yap sold 350 more than Mr Lim.  
If they sold 5420 apples, how many apples did Mr Lim sell?

Do not write  
in this column

Ans: \_\_\_\_\_ [3]

39. The figure below is made up of a small square, a big square and two identical rectangles. The length of the big square is thrice the length of the small square. Find the perimeter of the figure.

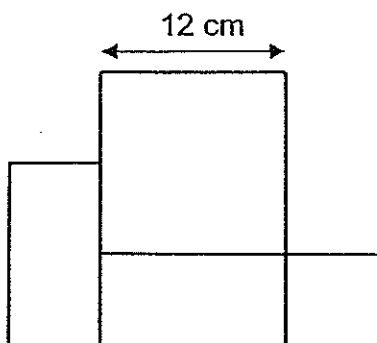

Ans: \_\_\_\_\_ [4]

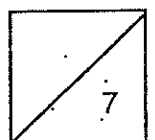

40. Charles had 520 blue and green marbles. After giving away  $\frac{1}{4}$  of the blue marbles and 30 of the green marbles, he had an equal number of blue and green marbles in the end. How many green marbles did he have at first?

Do not write  
in this column

Ans: \_\_\_\_\_ [4]

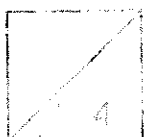

41. There are some lollipops in the box. If each child takes 6 lollipops, there will be 2 lollipops left in the box but if each child takes 7 lollipops, there will be 5 lollipops short. How many children are there?

Do not write  
in this column

Ans: \_\_\_\_\_ [4]

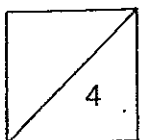

42. Mdm Eng measured the mass of an apple, a banana and a carrot. She found out that the mass of the apple and banana was 350g, the mass of the carrot and the banana was 370g and the mass of the apple and the carrot is 400g. What is the mass of the carrot?

Do not write  
in this column

Ans: \_\_\_\_\_ [4]

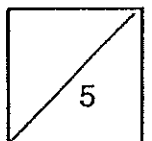

43. ABCD is a rectangular garden. It cost \$8 to fill  $1 \text{ m}^2$  of the shaded part around the pond with pebbles.

(a) Find the area of the pond.

(b) What is the cost of filling the shaded part around the pond with pebbles?

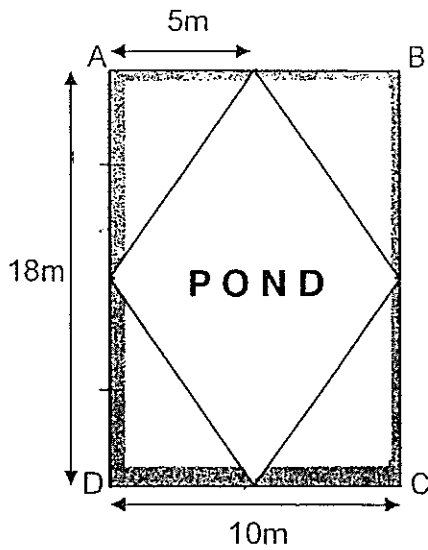

Ans: (a) \_\_\_\_\_ [3]

(b) \_\_\_\_\_ [1]

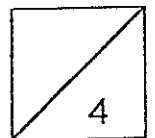



## Exam Paper 2014 Answer Sheet

**School: SINGAPORE CHINESE GIRLS' SCHOOL**  
**Subject: PRIMARY 4 MATHEMATICS**  
**Term: SA2**

1)	2	6)	1	11)	1
2)	3	7)	3	12)	3
3)	4	8)	2	13)	2
4)	2	9)	1	14)	3
5)	3	10)	3	15)	3

16. 200

17. 400

18.  $\frac{3}{4}$

19.  $3\frac{1}{5}$

20.  $\frac{1}{8}$

21.  $\frac{7}{8}$

22. 0.48

23. 28

24. 0.706, 0.607, 0.076

25.  $\frac{1}{3}$

26.  $1\frac{1}{6}$

27. 20

28. 49

29. 7.1

30.

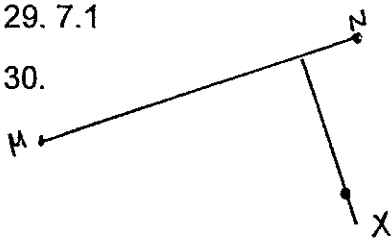

31.

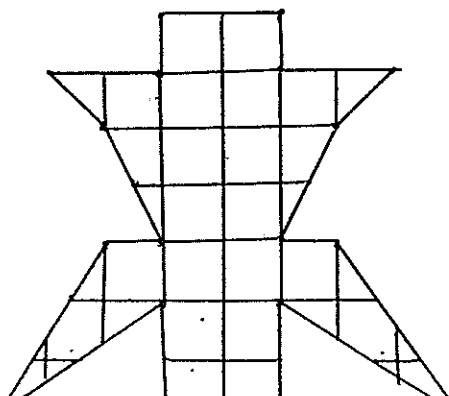

1910-1911

25-1-1911

26-1-1911

27-1-1911  
28-1-1911  
29-1-1911  
30-1-1911  
31-1-1911  
1-2-1911  
2-2-1911  
3-2-1911  
4-2-1911  
5-2-1911  
6-2-1911

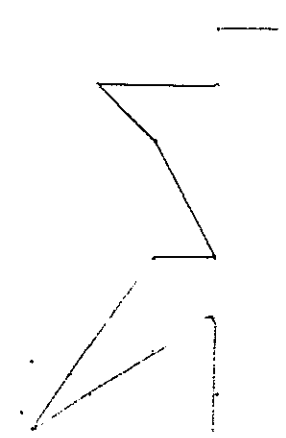



32.

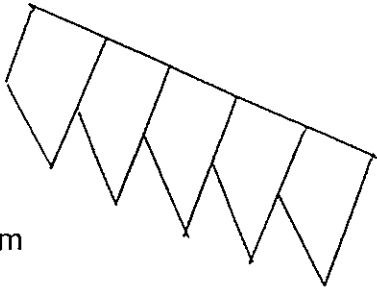

33. 2 pm

34. 40

35. 160

36.  $1u \rightarrow 1530 \div 9 = 170$   
 $4u \rightarrow 170 \times 4 = 680m = \mathbf{0.680km}$

37.  $2u \rightarrow 40$   
 $1u \rightarrow 20$   
 $6u \rightarrow \mathbf{120ml}$

38.  $6u \rightarrow 5420 - 350 = 5070$   
 $1u \rightarrow 5070 \div 6 = \mathbf{845}$

39. Perimeter =  $12 + 12 + 12 + 12 + 4 + 4 + 4 + 4 + 4 = \mathbf{72cm}$

40.  $7u \rightarrow 520 - 30 = 490$   
 $1u \rightarrow 490 \div 7 = 70$   
 $3u \rightarrow 70 \times 3 = 210$   
Green (at first)  $\rightarrow 210 + 30 = \mathbf{240}$

41.  $6 + 2 = 8$        $12 + 2 = 14$   
 $7 - 5 = 2$        $21 - 5 = 16$   
 $18 + 2 = 20$      $24 + 2 = 26$   
 $21 - 5 = 16$      $28 - 5 = 23$   
 $30 + 2 = 32$      $36 + 2 = 38$   
 $35 - 5 = 30$      $42 - 5 = 37$   
 $42 + 2 = 44$   
 $49 - 5 = 44$   
 $42 \div 6 = 7$

42.  $400 - 370 = 30$   
 $350 - 30 = 320$   
 $320 \div 2 = 160$   
 $370 - 160 = \mathbf{210g}$

43. (a)  $18 \times 10 = 180$   
 $18 \div 2 = 9$   
 $9 \times 5 = 45$   
 $45 \times 2 = 90$   
 $180 - 90 = \mathbf{90m^2}$   
(b)  $90 \times 8 = \mathbf{\$720}$



01. 1. 1. 1.

001

01	01	01	01
02	02	02	02
03	03	03	03
04	04	04	04
05	05	05	05
06	06	06	06
07	07	07	07
08	08	08	08
09	09	09	09
10	10	10	10

01 = 01  
 02 = 02  
 03 = 03  
 04 = 04

05 = 05  
 06 = 06  
 07 = 07  
 08 = 08  
 09 = 09  
 10 = 10