

Name: \_\_\_\_\_ ( )

Class : Primary 4 \_\_\_\_\_

**CHIJ ST NICHOLAS GIRLS' SCHOOL (PRIMARY)**

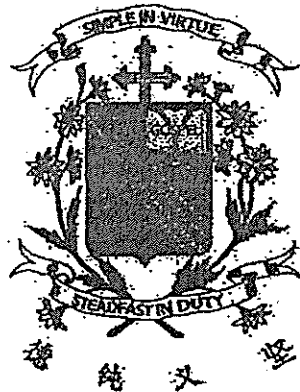

**Primary 4 Mathematics**

**2014 Semestral Assessment Two**

**Booklet A**

**28 October 2014**

**TOTAL TIME FOR BOOKLETS A AND B: 1 HOUR 45 MINUTES**

Do not turn over this page until you are told to do so.  
Follow all instructions carefully.  
Answer all questions.

This booklet consists of 10 printed pages including the cover page.

Section A: (20 x 2 marks)

For each question, four options are given. One of the options is the correct answer. Shade the correct oval (1, 2, 3 or 4) on the Optical Answer Sheet. Please use only 2B pencil and SHADE the oval completely.

---

1.  $80\,000 + 3000 + 400 + 2 =$  \_\_\_\_\_

1) 83 420

2) 83 402

3) 83 042

4) 80 342

2. Which of the following is a multiple of 6?

1) 36

2) 22

3) 16

4) 3

3. Express  $\frac{27}{100}$  as a decimal.

1) 0.207

2) 0.027

3) 0.27

4) 2.07

4. Which one of the following has  $\frac{1}{3}$  of the figure shaded?

1)

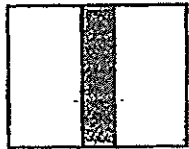

2)

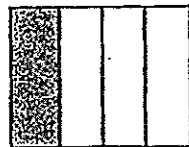

3)

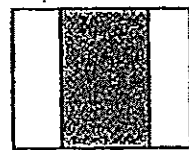

4)

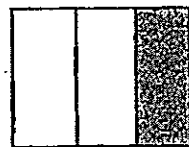

5.  $20.73 \times 8 =$  \_\_\_\_\_

1) 165.84

2) 160.84

3) 160.73

4) 28.73

6. One of the lines in the figure is parallel to BC. Which line is parallel to BC?

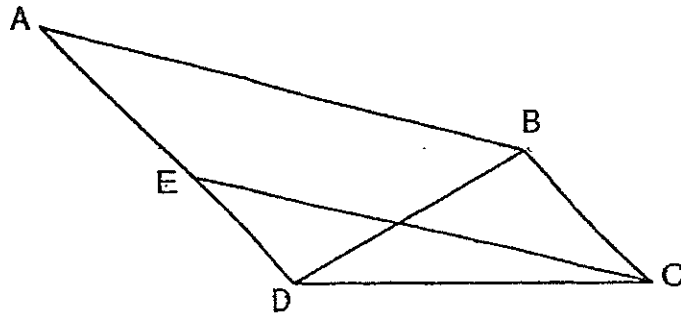

- 1) AD
  - 2) AB
  - 3) BD
  - 4) DB
7.  $32 \times 45 = \underline{\hspace{2cm}} \times 5$
- 1) 7200
  - 2) 1440
  - 3) 385
  - 4) 288
8.  $5 \text{ min } 16 \text{ s} = \underline{\hspace{2cm}} \text{ s}$

- 1) 21
- 2) 80
- 3) 316
- 4) 516

9. What is the decimal shown below?

tens	ones	.	tenths	hundredths	thousandths

- 1) 3.112
- 2) 3.22
- 3) 30.112
- 4) 30.22

10. Look at the figure below. Which one of the following statements is correct?

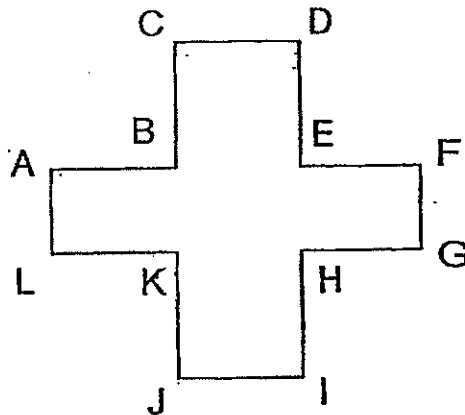

- 1) EF is parallel to HI.
- 2) CD is parallel to CB.
- 3) AB is perpendicular to JI.
- 4) KJ is perpendicular to LK.

11. The square below is not drawn to scale. Find  $\angle n$ .

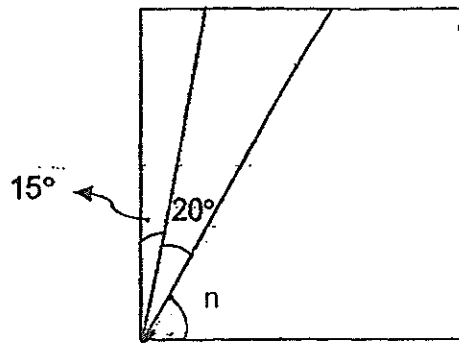

- 1)  $25^\circ$
- 2)  $35^\circ$
- 3)  $45^\circ$
- 4)  $55^\circ$

12. The figure below is made up of 3 identical rectangles. The length of the rectangle is 7 cm and its breadth is 3 cm. What is the perimeter of the figure?

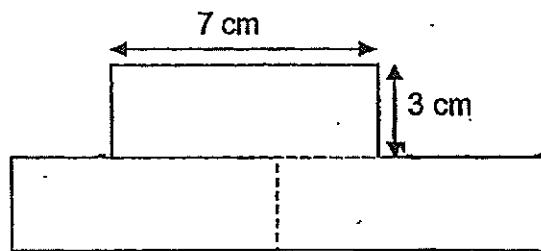

- 1) 20 cm
- 2) 33 cm
- 3) 40 cm
- 4) 60 cm

13. Which of the following groups of decimals is arranged from the smallest to the greatest?
- 1) 3.7, 3.17, 3.171
  - 2) 4.891, 4.19, 4.98
  - 3) 9.73, 9.37, 9.573
  - 4) 7.7, 7.706, 7.760
14. Gillian went for a gathering with her friends. She left home at 20 50 and returned home at 00 30 the next day. How long was she out that night?
- 1) 3 h 20 min
  - 2) 3 h 40 min
  - 3) 4 h 20 min
  - 4) 4 h 40 min
15. 1 ruler cost as much as 2 erasers of the same type. Malcolm paid \$4.80 for 1 ruler and 4 such erasers. Find the cost of 1 eraser.
- 1) \$0.80
  - 2) \$0.96
  - 3) \$1.20
  - 4) \$1.60

16. Mr Ng bought a carpet measuring 4 m by 2 m. He placed it in the middle of a rectangular room, leaving a border of 1 m around it. What was the area of the room **not** covered by the carpet?

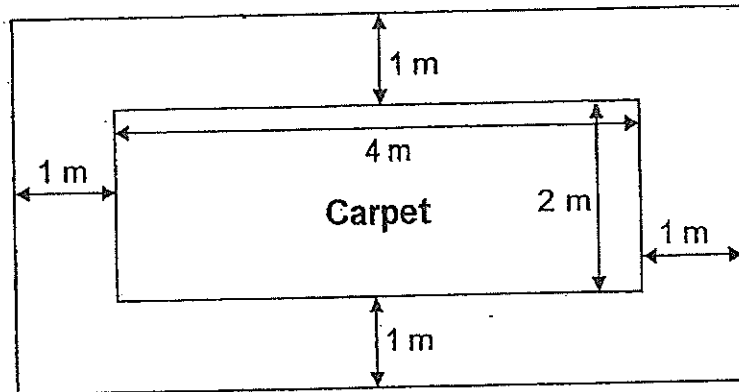

- 1)  $7 \text{ m}^2$   
2)  $8 \text{ m}^2$   
3)  $16 \text{ m}^2$   
4)  $24 \text{ m}^2$
17. The following figure is a rectangle. Which 2 angles add up to  $90^\circ$ ?

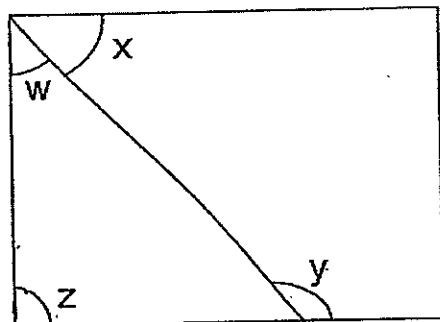

- 1)  $\angle w$  and  $\angle x$   
2)  $\angle x$  and  $\angle y$   
3)  $\angle y$  and  $\angle z$   
4)  $\angle x$  and  $\angle z$



- 18 The figure, not drawn to scale, is made up of 2 squares and 2 rectangles. A and B are squares. Find the area of Rectangle D.

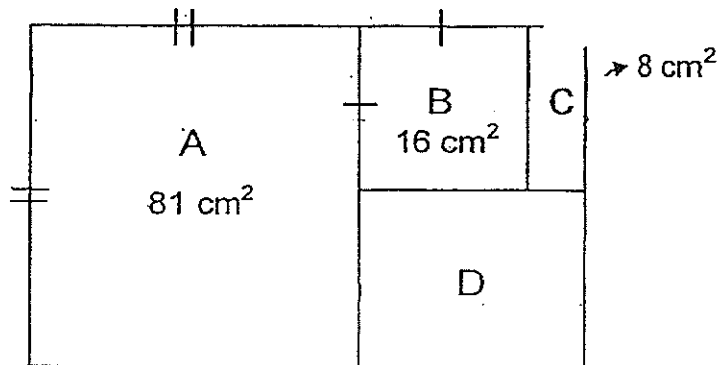

- 1)  $57 \text{ cm}^2$   
2)  $30 \text{ cm}^2$   
3)  $25 \text{ cm}^2$   
4)  $24 \text{ cm}^2$
- 19: Victoria is 36.4 kg. She is 6.25 kg heavier than Wendy. Yannie is 3.8 kg lighter than Wendy. What is the mass of Yannie?
- 1) 26.35 kg  
2) 38.85 kg  
3) 56.5 kg  
4) 81.5 kg

20. Which of the shapes below **cannot** be tessellated?

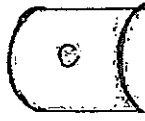
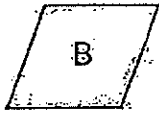

- 1) A
- 2) B
- 3) C
- 4) D

**- END OF BOOKLET A -**

Name : \_\_\_\_\_ ( )

Class : Primary 4 \_\_\_\_\_

**CHIJ ST NICHOLAS GIRLS' SCHOOL (PRIMARY)**

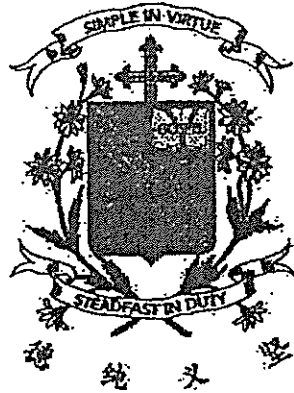

**Primary 4 Mathematics**

**2014 Semestral Assessment Two**

**Booklet B**

**28 October 2014**

<b>Booklet A :</b>	<b>/ 40</b>
<b>Booklet B :</b>	<b>/ 60</b>
<b>Total :</b>	<b>/ 100</b>

\_\_\_\_\_  
Parent's/Guardian's Signature

**TOTAL TIME FOR BOOKLETS A AND B: 1 HOUR 45 MINUTES**

**Do not turn over this page until you are told to do so.  
Follow all instructions carefully.  
Answer all questions.**

**This booklet consists of 16 printed pages including the cover page**

**Section B: (20 x 2 marks)**

Do not  
write in  
this  
space

Write down your answers in the spaces provided. For questions which require units, give your answers in the units stated. Show all workings clearly.

21. Round off 43 510 to the nearest hundred.

Ans : \_\_\_\_\_

22.  $5006 - 843 =$  \_\_\_\_\_

Ans : \_\_\_\_\_

23. Arrange the following fractions from the greatest to the smallest.

Ans : \_\_\_\_\_ , \_\_\_\_\_ , \_\_\_\_\_  
(greatest) (smallest)

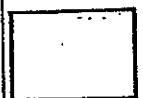

Do not  
write in  
this  
space

24. Write the decimal represented by A.

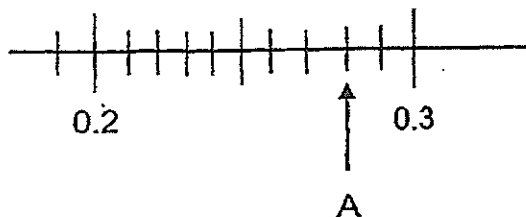

Ans : \_\_\_\_\_

25. Find the value of  $1 - \frac{1}{8} - \frac{1}{4}$ .

Ans : \_\_\_\_\_

26.

$$0.4 = \frac{4}{\boxed{?}}$$

What is the missing number in the box?

Ans : \_\_\_\_\_



Do not  
write in  
this  
space

27. Measure and write down the size of  $\angle z$ .

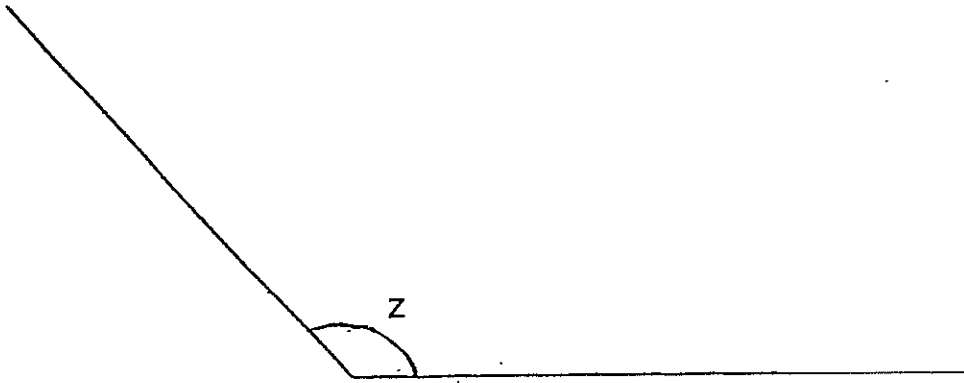

Ans : \_\_\_\_\_<sup>o</sup>

28. Write  $\frac{10}{3}$  as a mixed number in its simplest form.

Ans : \_\_\_\_\_

29.  $9.2 - 0.69 =$  \_\_\_\_\_

Ans : \_\_\_\_\_



Use the following figure to answer questions 30 and 31.

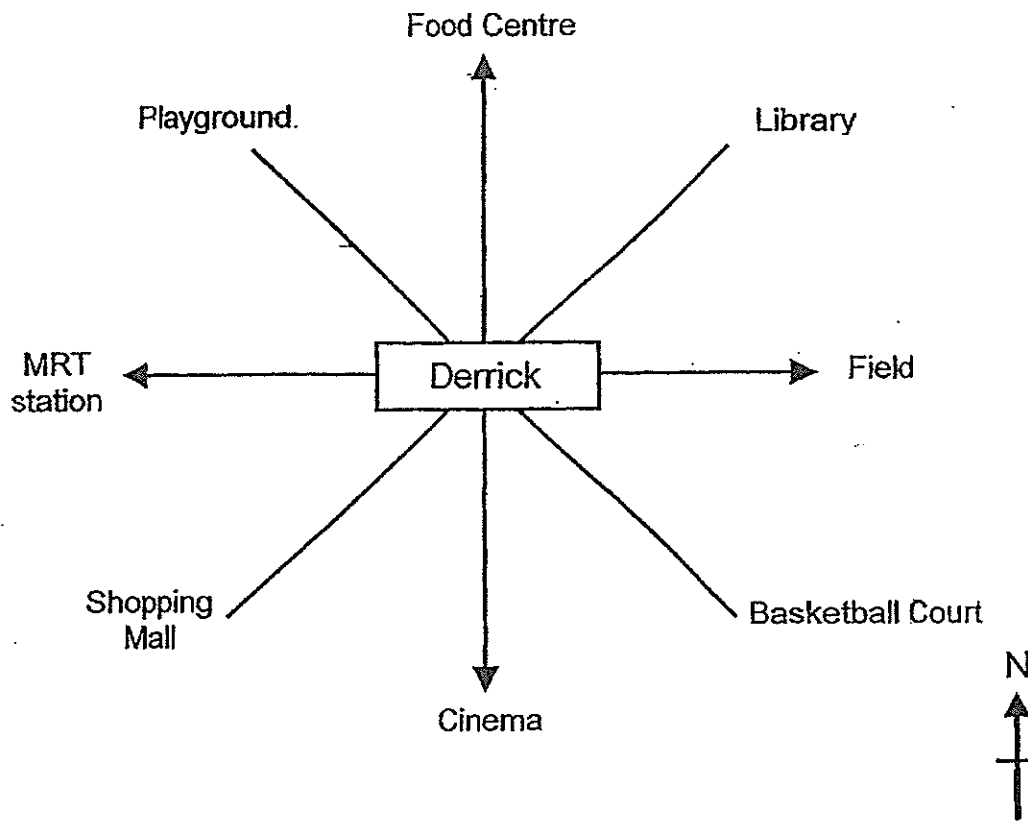

Do not write in this space

30. Which place is in the southwest direction?

Ans : \_\_\_\_\_

31. Derrick stands in the centre. If he turns through an angle of  $135^\circ$  in the clockwise direction, he will face the library. Where was he facing at first?

Ans : \_\_\_\_\_



Do not  
write in  
this  
space

32. Find the sum of 0.27 and 1.9.  
Express your answer as a mixed number.

Ans : \_\_\_\_\_

33. Vini bought 4 books of the same cost. She gave the cashier \$50 and received a change of \$15. How much did each book cost?

Ans : \$ \_\_\_\_\_

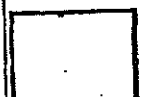



Do not write in this space

34. What is the sum of all the factors of 20?

Ans : \_\_\_\_\_

35. The line graph shows the amount of money donated by 3 classes in Primary Four.

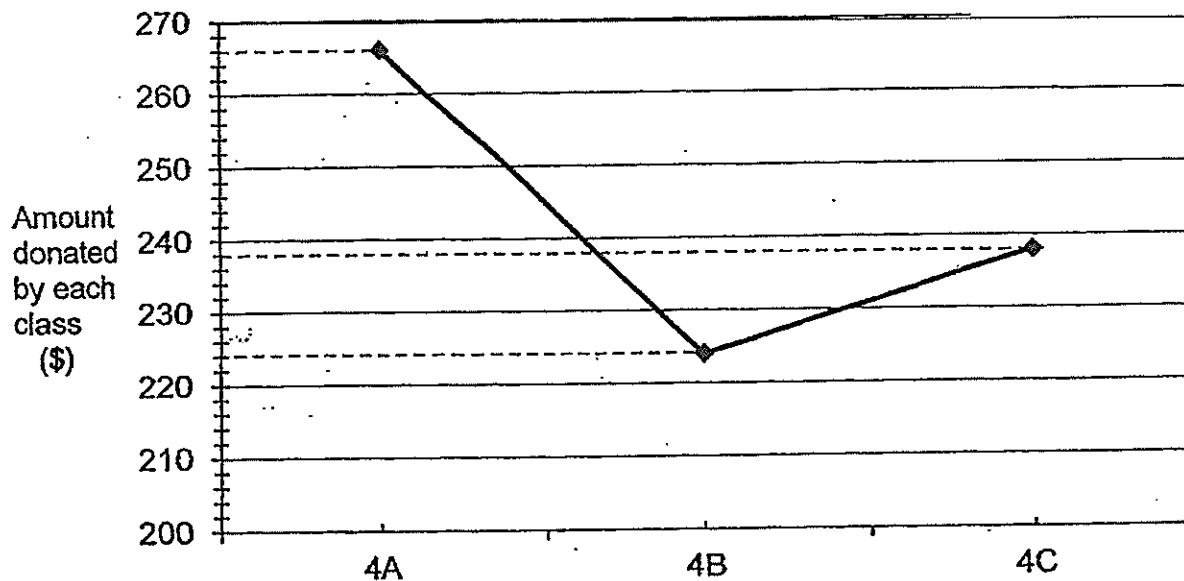

Each pupil donated \$7. How many pupils were there altogether in the 3 classes?

Ans : \_\_\_\_\_



Do not  
write in  
this  
space

36. Mr Charlie had 80 red marbles and 150 blue marbles. He gave all the red marbles to his nephew. He also gave  $\frac{4}{5}$  of the blue marbles to his pupils. How many more marbles did he give his pupils than his nephew?

Ans : \_\_\_\_\_

37. Mr Tan had 50 red pins when rounded off to the nearest ten.  
Mrs Tan had 70 blue pins when rounded off the nearest ten.  
What was the greatest possible number of pins that they had altogether?

Ans : \_\_\_\_\_



Do not  
write in  
this  
space

38. In the figure below, the line of symmetry is XY.  
Shade 2 more squares so that the figure is symmetrical.

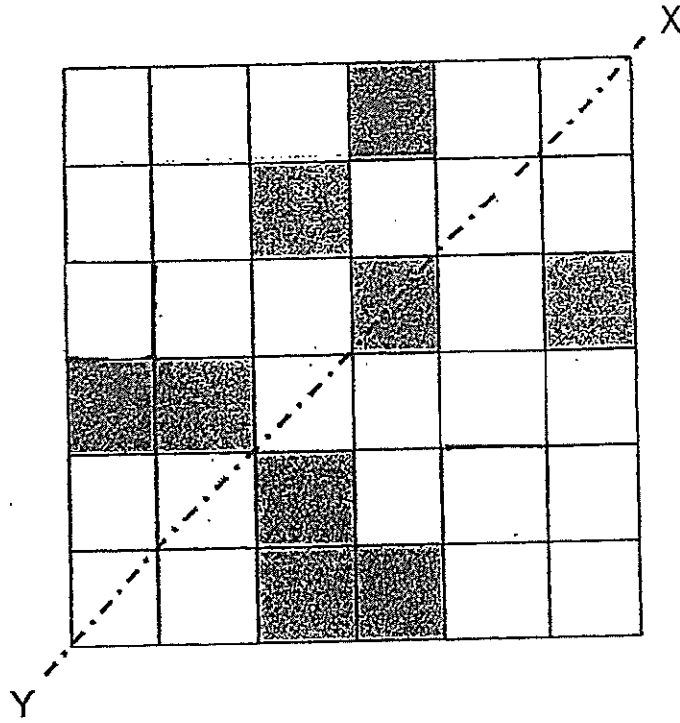

39. Chloe's watch is 15 minutes slower than the actual time. She has a dinner appointment at 6 p.m. She needs 1 h 25 min to reach the restaurant. According to her watch, what time must Chloe leave her house to arrive at the restaurant punctually? Express your answer in the 12-hour clock.

Ans : \_\_\_\_\_ p.m.

40. The figure below is not drawn to scale. The perimeter of the rectangle is 96 cm. The length is twice its breadth. What is the length of the rectangle?

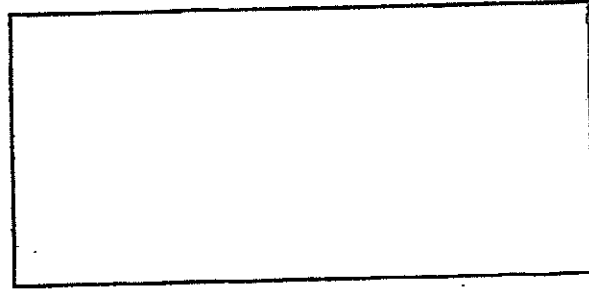

Do not write in this space

Ans : \_\_\_\_\_ cm

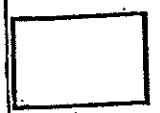

**ion C: (20 marks)**

Questions 41 to 46, show your working clearly and write your answers in the spaces provided. The number of marks available is shown in brackets [ ] at the end of each question or part-question.

There are 364 children in Sunshine Primary School. The principal wants to give each child 27 cookies for Children's Day. If the cookies come in packets of 5, what is the minimum number of packets the school has to buy?

Do not write in this space

Ans : \_\_\_\_\_ [3]

At an exhibition, there were 5 times as many adults as children. After 206 adults and 30 children left the exhibition, the number of adults was the same as the number of children. How many people were there at the exhibition at first?

Ans :

[4]



**\*\*END OF PAPER\*\***

# CHIJ ST NICHOLAS GIRLS' SCHOOL (PRIMARY)

## Primary 4 Mathematics

### 2014 Semestral Assessment Two

- 1) 2
- 2) 1
- 3) 3
- 4) 4
- 5) 1
- 6) 1
- 7) 4
- 8) 3
- 9) 4
- 10) 4
- 11) 4
- 12) 3
- 13) 4
- 14) 2
- 15) 1
- 16) 3
- 17) 1
- 18) 2
- 19) 1
- 20) 4
- 21) 43 500
- 22) 4 163

23)  $7/12, 1/2 = 6/12, 5/6 = 10/12$

Ans:  $5/6, 7/12, 1/2$

24) 0.28

25)  $1 - 1/8 - 1/4 = 8/8 - 1/8 - 2/8 = 5/8$

26) 10

27)  $132^\circ$

28)  $3/1/3$

29) 8.51

30) Shopping Mall

31) MRT station

32)  $27/100 + 1/90/100 = 2/17/100$

33)  $\$50 - \$15 = \$35$

$\$35/4 = \$8.75$

34)  $1+2+4+5+10+20 = 42$

35)  $266+224+238 = 728$

$728/7 = 104$  pupils

36)  $4/5 \times 150 = 120$  (pupils)

$120 - 80 = 40$  more marbles

37)  $54+74 = 128$  pins

38)

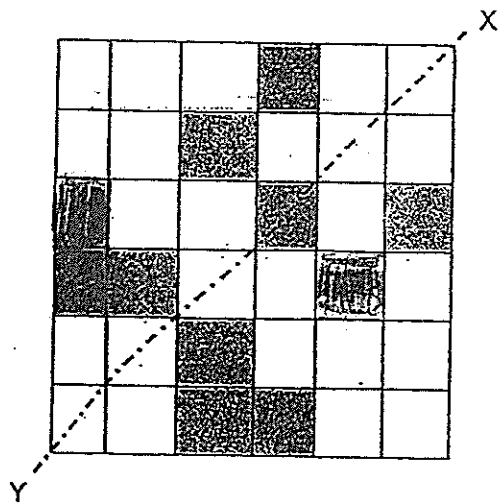



39)  $1\text{h } 25\text{min} + 15\text{min} = 1\text{h } 40\text{min}$

$18\text{h } 00\text{min} - 1\text{h } 40\text{min} = 16\text{h } 20\text{min} = 4.20\text{pm}$

40)  $2u + 2u + 1u + 1u = 6u$

$96\text{cm}/6 = 16\text{ cm}$

$16\text{cm} \times 2 = 32\text{ cm}$

41)  $27 \times 364 = 9828$

$9828/5 = 1965 \text{ R } 3$

$1965+1 = 1966$  packets of cookies

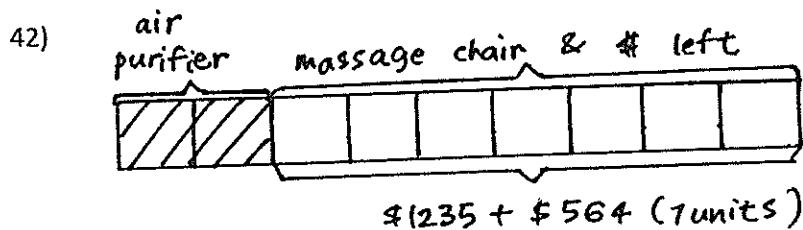

$\$1235 + \$564 = \$1799$

$9u - 2u = 7u$

$7u \rightarrow \$1799$

$2u \rightarrow 2/7 \times \$1799 = \$514$

43)  $40 - 6 - 18 = 16$  (10c coins between Felice & Ginny)

$16/4 = 4$

$4 \times 3 = 12$  (number of 10c coins Ginny had)

$12 \times \$0.10 = \$1.20$  (value of 10c coins Ginny had)

$20 - 6 - 3 - 5 = 6$  (number of 50c coins)

$6 \times \$0.50 = \$3$  (value of 50c coins Ginny had)

$\$1.20 + \$3 = \$4.20$  (amount of money Ginny had)

44)  $100\text{cm}/4 = 25\text{ cm}$  (length of big square)

$25-6-6 = 13\text{ cm}$  (length of small square)

$13\text{cm} \times 4 = 52\text{ cm}$  (perimeter of the square)

45)  $20\text{m}-1.65\text{m}-1.65\text{m} = 16.7\text{ m}$

$16.7\text{m}/5 = 3.34\text{ m}$

46)

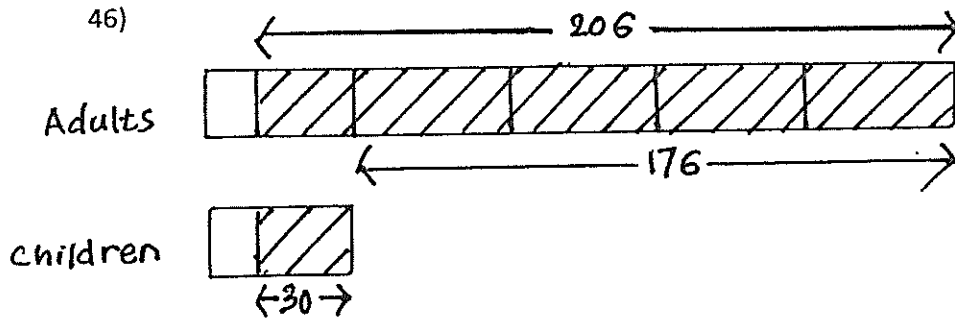

$206-30 = 176$

$176/4 = 44$

$44 \times 6 = 264$  people were at the exhibition at first