

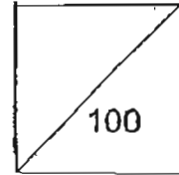

HENRY PARK PRIMARY SCHOOL
2011 SEMESTRAL EXAMINATION 2
MATHEMATICS
PRIMARY 4

Duration of Paper: 1 h 45 min



Name: _____ ()

Parent's Signature

Class: Pr 4: _____

PART A (15 x 2 marks = 30 marks)

Read each question carefully. For each question, there are 4 options given. Choose the correct answer and write the number in the bracket provided.

1. $6 \times 10\,000 + 3 \times 1000 + 7 \times 100 + 8 \times 1 =$ _____

- (1) 63 781
- (2) 63 708
- (3) 63 701
- (4) 63 078

()

2. Which one of the following has $\frac{1}{3}$ of the figure shaded?



()

3. In 73.68, which digit is in the tenths place?

- (1) 6
- (2) 7
- (3) 3
- (4) 8

()

4. Which of the following figures are symmetrical?

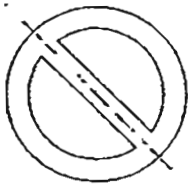

Figure A

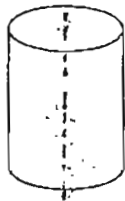

Figure B

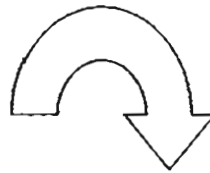

Figure C

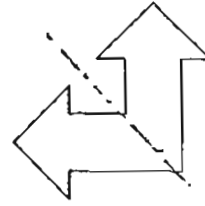

Figure D

- (1) Figures A and C only
- (2) Figures B and D only
- (3) Figures A, B and C only
- (4) Figures A, B and D only

()

5. The cost of a pair of shoes when rounded off to the nearest dollar is \$50. Which of the following could possibly be the actual price of the pair of shoes?

- (1) \$49.45
- (2) \$49.50
- (3) \$50.51
- (4) \$51.20

()

6. Which number below is 10 more than 3584?

- (1) 3574
- (2) 3583
- (3) 3585
- (4) 3594

()

7. Which of the following are common factors of 18 and 24?

- (1) 1 and 9
- (2) 2 and 4
- (3) 3 and 6
- (4) 6 and 9

()

8. Which of the following is nearest to 3?

(1) $2\frac{2}{3}$

(2) $2\frac{3}{4}$

(3) $3\frac{1}{2}$

(4) $3\frac{1}{5}$

()

9. Write $5\frac{1}{4}$ as a decimal.

(1) 5.1

(2) 5.4

(3) 5.14

(4) 5.25

()

10. Which of the following shapes can be tessellated?

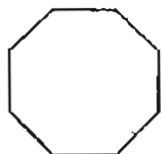

Figure A

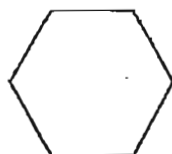

Figure B

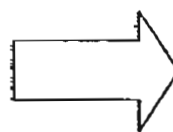

Figure C



Figure D

(1) Figures A and D only

(2) Figures B and C only

(3) Figures A, B and D only

(4) Figures B, C and D only

()

11. The table below consists of numbers from 1 to 16. Which number is Southeast of '6' and North of '15'?

1	2	3	4
5	6	7	8
9	10	11	12
13	14	15	16



- (1) 7
- (2) 9
- (3) 3
- (4) 11

()

12. Ali had 62 sweets and Ben had 48 sweets. How many sweets must Ben take from Ali so that they have the same number of sweets?

- (1) 7
- (2) 12
- (3) 14
- (4) 24

()

13. Shafira started reading a book at 16 45. She finished reading the book at 18 15. How long did she take to read the book?

- (1) 1 h 30 min
- (2) 2 h
- (3) 2 h 30 min
- (4) 3h

()

14. Joseph drank $\frac{1}{3}$ ℓ of water at the start of a race. He then drank another $\frac{5}{6}$ ℓ of water at the end of the race. How much water did he drink altogether?

(1) $\frac{1}{2}$ ℓ

(2) $\frac{2}{3}$ ℓ

(3) $1\frac{1}{5}$ ℓ

(4) $1\frac{1}{6}$ ℓ

()

15. Victor exchanged 12 fifty-cent coins and some twenty-cent coins for a \$10 note with his sister. How many twenty-cent coins did he receive?

(1) 30

(2) 20

(3) 6

(4) 4

()

End of Part A

Name: _____ ()

Class: Pr 4 _____

PART B (20 x 2 marks = 40 marks)

Read each question carefully and write down the correct answer in the boxes provided. Show all workings clearly.

16. $4752 \div 6 =$ _____

17. Fill in the blank with the correct number in the number pattern below.

83, 101, 119, _____, 155

18. Which two fractions below are smaller than $\frac{1}{2}$?

$\frac{2}{3}$, $\frac{2}{5}$, $\frac{2}{7}$, $\frac{2}{4}$

19. Write $\frac{14}{8}$ as a mixed number in its simplest form.

The line graph shows the temperature at different times of the day for a town in Hong Kong. Study the graph carefully and answer Questions 20 and 21.

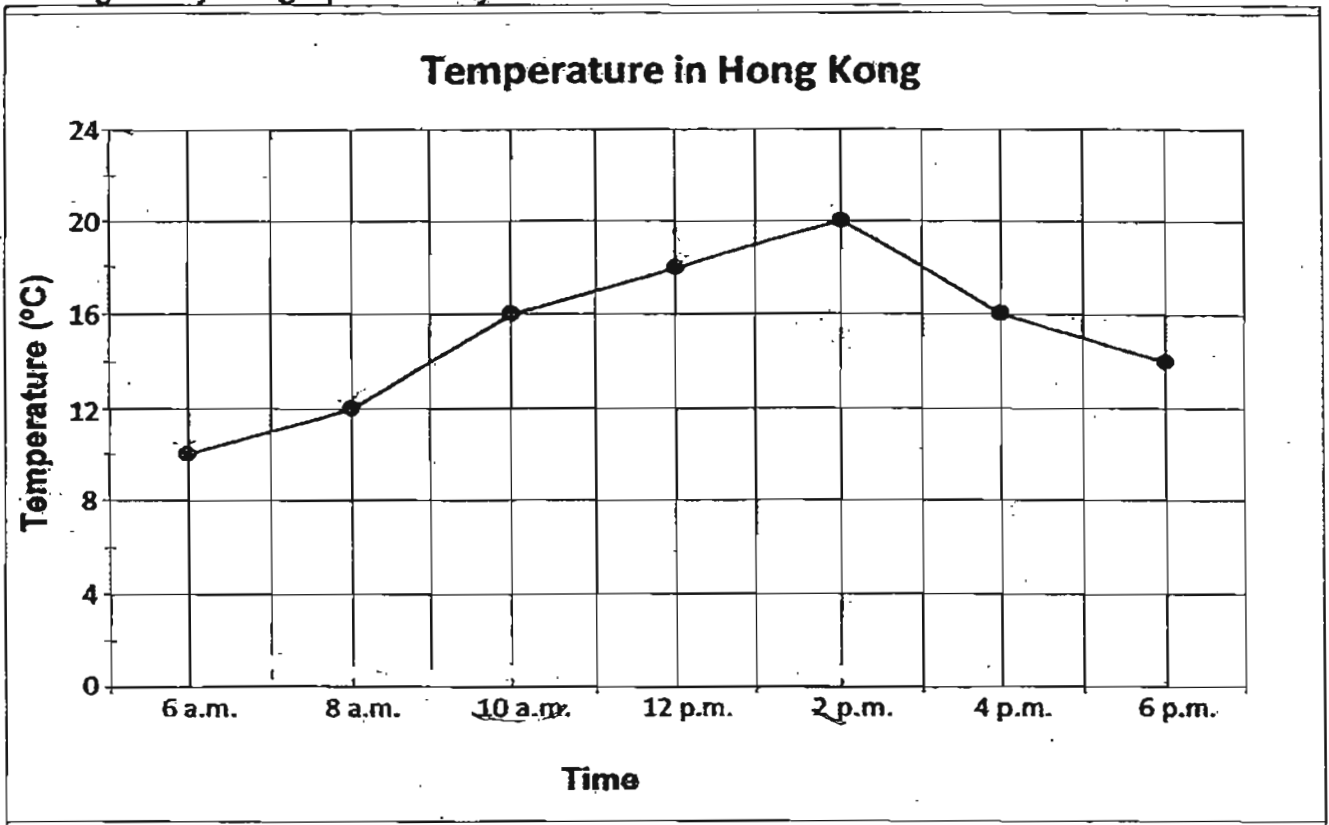

20. At what time was the recorded temperature the highest?

Give your answer in the 24-hour clock.

21. During which 2-hour interval did the recorded temperature increase by 4°C ?

Give your answer in the 24-hour clock.

 to

22. In the figure, name the two angles that are greater than 90° .

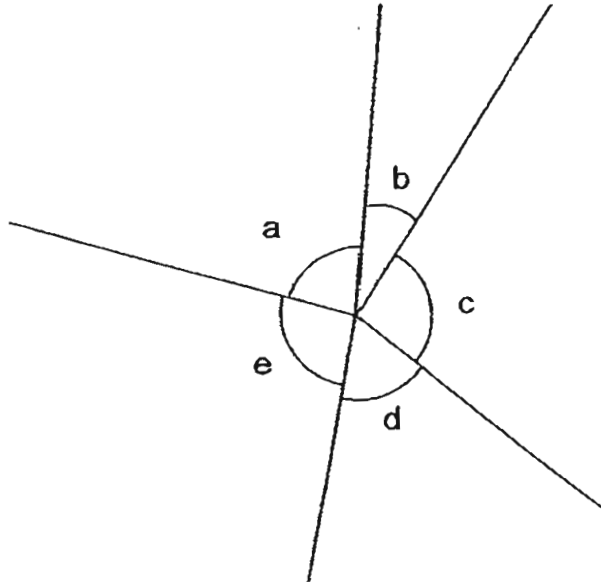

_____ and _____

23. In the figure, one of the lines is parallel to FC. Which line is parallel to FC?

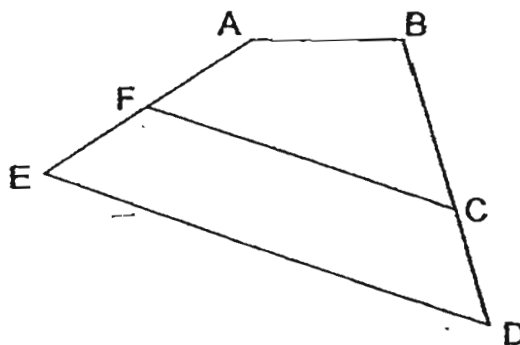

--

24. Susan watched a movie that ended at 17 30. The movie lasted 1 h 45 min. What time did the movie start? Leave your answer in 24-hour clock.

25. The area of a square is 64 cm^2 . What is the perimeter of the square?

 cm

26. Find the value of $1 - \frac{1}{10} - \frac{1}{5}$

27. Arrange the following numbers in order from the **smallest to the greatest**.
Write your answers in the blanks provided.

6.01, 6.1, 6.001, 6

_____ , _____ , _____ , _____
(smallest) (greatest)

28. The table below shows the time taken by some children to complete a cross-country race. Study it carefully and answer Question 28.

Name	Time taken in minutes
Nicholas	74
Shannon	60
Wei Ming	?

Wei Ming completed the race in $\frac{5}{6}$ of the time taken by Shannon. How long did Wei Ming take to complete the race?

min

29. ABCD is a square. Find $\angle x$.

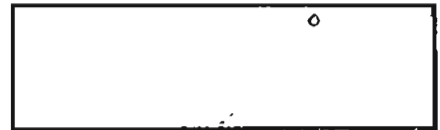
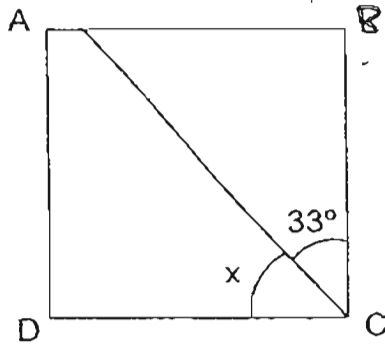

30. Measure and write down the size of $\angle x$.

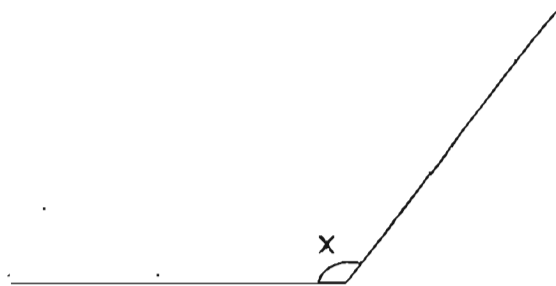

31. At a fun fair, a bonus of 2 stickers was awarded for every 6 stickers won. Samuel collected a total of 35 stickers. How many stickers did he actually win?

32. When a boat reached the jetty, $\frac{1}{5}$ of the passengers went ashore and 4 new passengers boarded the boat. There were now 36 passengers on board the boat. How many passengers were on board the boat before it reached the jetty?

33. Find the value of 6.75×8 .

34. Victor exercises 4 times a week. He exercises 2 hours each time.
How many weeks will Victor need to reach 200 hours of exercise?

35. A roll of wire 48 cm long is cut into 2 pieces to form Square A and Square B.
36 cm of the wire is used to form Square A.
Find the length of each side of Square B.

 cm

End of Part B

Name:

()

Class: Pr 4

PART C (30 marks)

Read the following problem sums carefully. Show all workings clearly in the spaces provided. The number of marks available is shown in brackets () at the end of each question or part-question.

36. Shannon had 32 m of ribbon. She gave away 5 pieces of ribbon, each measuring 2.65 m long. She also gave away another piece, measuring 12.8 m long.

How many metres of ribbon had she left?

(4 marks)

Working

Ans: _____

37. A rope has 12 knots which are spaced out equally. The distance between the first knot and seventh knot is 4.2 m. What is the distance between the fourth knot and the last knot?

(3 marks)

Working

Ans: _____

38. There were thrice as many boys as girls at a camp. After 72 boys left the camp, the number of girls was $\frac{2}{3}$ the number of boys. What is the total number of boys and girls who remained at the camp? (3 marks)

Working

Ans: _____

39. The figure below shows a grass field with a rectangular pond in it.
The area of the field covered in grass is 128 m^2 .
What is the perimeter of the field?

(4 marks)

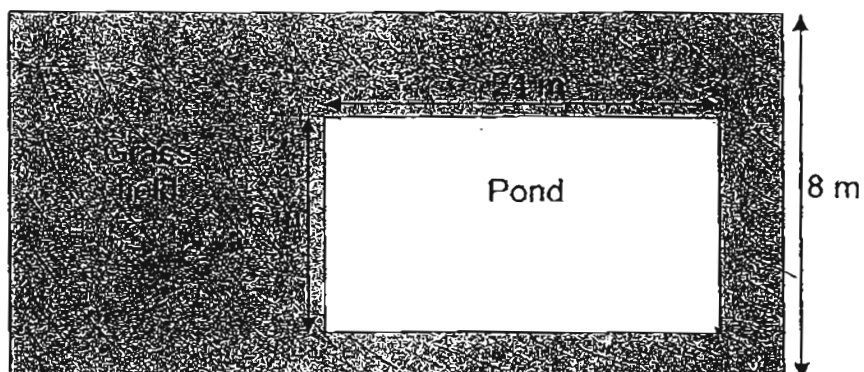

Working

Ans: _____

40. A bus started its journey from Depot A at 7 a.m. For every 10 minutes that it travelled, it stopped for 2 minutes at a bus stop. The bus stopped at 10 bus stops. From the 10th bus stop, it travelled another 15 minutes before it ended its journey at Depot B. At what time did the bus reach Depot B? (4 marks)

Working

Ans: _____

41. At the bus interchange, some passengers boarded the bus. At the first stop, 17 passengers alighted and 3 passengers boarded the bus. At the second stop, only 24 passengers boarded the bus. When the bus left the second stop, there were 54 passengers on the bus. How many passengers boarded the bus at the bus interchange? (4 marks)

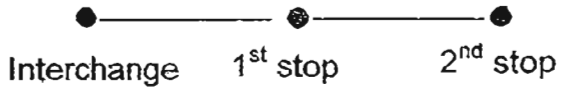

Working

Ans: _____

42. Jim and Sam had 234 cards altogether. After Jim lost 36 of his cards and Sam gave away $\frac{1}{5}$ of his cards, they had the same number of cards left. How many cards did Jim and Sam have left altogether?

(4 marks)

Working

Ans: _____

43. At the beginning of the month, Pet Shop A and Pet Shop B had the same number of hamsters. By the end of the month, Pet Shop A sold 38 hamsters and Pet Shop B sold 70 hamsters. The number of hamsters left in Pet Shop A was 5 times the number of hamsters in Pet Shop B. What was the total number of hamsters in both shops before any of the hamsters were sold from them? (4 marks)

Working

Ans: _____

END OF PAPER

Setters: Mdm Ong Li Ling
Ms Eunice Chua

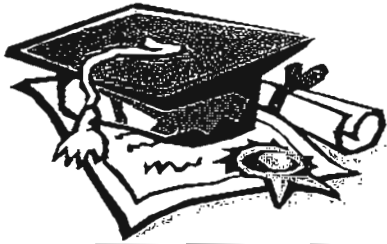

ANSWER SHEET

EXAM PAPER 2011

**SCHOOL : HENRY PARK
SUBJECT : PRIMARY 4 MATHEMATICS**

TERM : SA2



Q1	Q2	Q3	Q4	Q5	Q6	Q7	Q8	Q9	Q10	Q11	Q12	Q13	Q14	Q15
2	2	1	4	2	4	3	4	4	4	4	1	1	4	2

- 16)792 17)137 18) $2/5, 2/7$ 19) $1\frac{3}{4}$ 20)1400
- 21)0800 to 1000 22) $\angle c$ and $\angle e$ 23)ED 24)1545 25)32cm
- 26) $7/10$ 27)6, 6.001, 6.01, 6.1 28)50min 29) 57° 30) 128°
- 31)27 32)40 33)54 34)25 weeks 35)3cm
- 36) $2.65 \times 5 = 13.25$
 $13.25 + 12.8 = 26.05$
 $32 - 26.05 = 5.95m$
- 37) $4.2m \div 6 = 0.7m$
 $0.7m \times 8 = 56m$
- 38) $72 \div 3 = 24$
 $24 \times 5 = 120$ children
- 39) $24 \times 6 = 144m^2$
 $128m^2 + 144m^2 = 272m^2$
 $272m^2 \div 8 = 34m$
 $34m + 8m = 42m$
 $42m \times 2 = 84m$
- 40)9.15a.m.
- 41) $54 - 24 = 30$
 $30 - 3 = 27$
 $27 + 17 = 44$ passengers
- 42) $234 - 36 = 198$
 $198 \div 9 = 22$
 $22 \times 8 = 176$ cards
- 43) $70 - 38 = 32$
 $32 \div 4 = 8$
 $8 \times 10 = 80$
 $38 \times 2 = 76$
 $80 + 76 = 156$ hamsters

