

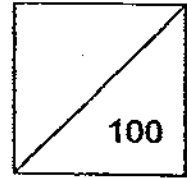

**HENRY PARK PRIMARY SCHOOL
2009 SEMESTRAL EXAMINATION 2
MATHEMATICS
PRIMARY 4**



Name: _____ ()

Parent's Signature

Class: Pr 4 _

Duration of Paper: 1 h 45 min

Section A: (15 x 2 marks = 30 marks)

For each question, four options are given. One of them is the correct answer. Make your choice (1,2,3 or 4). Shade the correct ovals on the Optical Answer Sheet.

1. 26 thousands and 5 tens is the same as _____.

- (1) 265
- (2) 2650
- (3) 26 005
- (4) 26 050

()

2. $4108 = 4 + \frac{8}{\square}$

- (1) 1
- (2) 10
- (3) 100
- (4) 1000

()

3. The digit 9 in 43.982 stands for 9 _____.

- (1) ones
- (2) tens
- (3) tenths
- (4) hundredths

()

4. One of the lines in the figure is parallel to CG. Which line is parallel to CG?

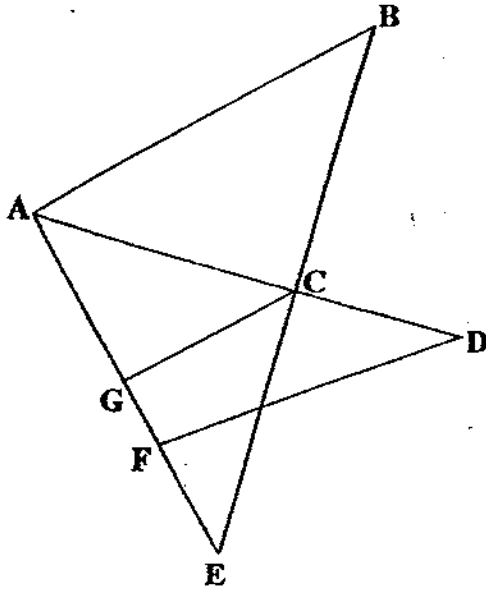

- (1) AB
- (2) AE
- (3) DA
- (4) DF

()

5. On a clock that has numbers 1 to 12 printed on the face, how many seconds does it take for the second hand of a clock to move from '10' to '5'?

- (1) 7 seconds
- (2) 35 seconds
- (3) 50 seconds
- (4) 70 seconds

()

6. Which of the following numbers when rounded off to the nearest ten becomes 42 500? ~~42 500~~

- (1) 42 445
- (2) 42 496
- (3) 42 506
- (4) 42 554

()

7. What is the sum of all the common factors of 7 and 14?

- (1) 7
- (2) 8
- (3) 21
- (4) 24

()

8. How many two-fifths are there in 2 wholes?

- (1) 20
- (2) 10
- (3) 5
- (4) 4

()

9. What fraction of the shapes in the box are  ?

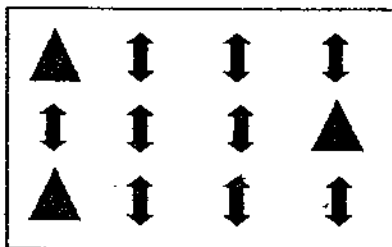

- (1) $\frac{1}{4}$
- (2) $\frac{1}{3}$
- (3) $\frac{3}{7}$
- (4) $\frac{3}{4}$

()

10. What is the length of the set of 2 stamps as shown in the figure below?

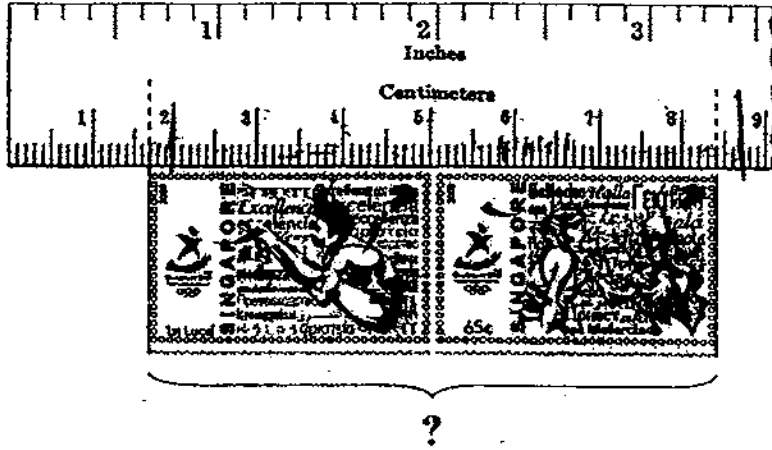

- (1) 5.7 cm
- (2) 6.1 cm
- (3) 6.7 cm
- (4) 8.4 cm

()

11. In which figures can the line of symmetry be drawn?

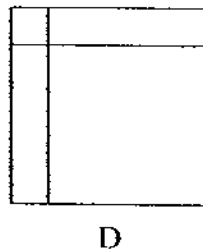
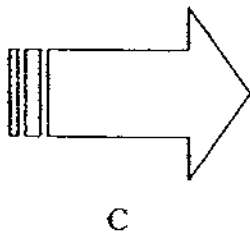
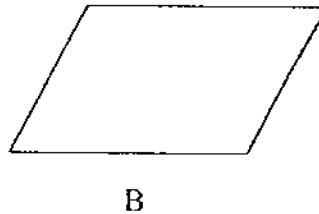
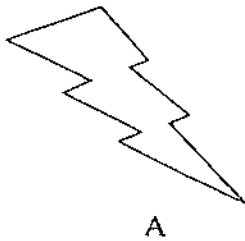

- (1) ~~B only~~ A and C only
- (2) B and D only
- (3) C and D only
- (4) B, C and D only

()

12. Which of these unit shapes can be tessellated?

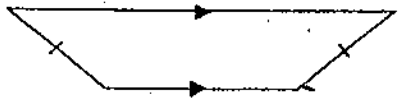

A

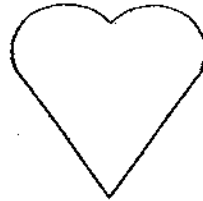

B

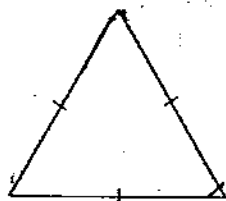

C

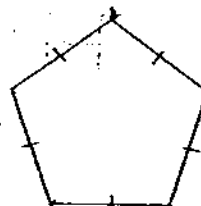



D

- (1) B only
- (2) A and C only
- (3) C and D only
- (4) A, C and D only

()

13. Simeon had less than \$36 in her purse. She bought 3 boxes of chocolates with all her money. What could be the largest possible amount of money in her purse?

		
\$8.45	\$11.80	\$16.35

- (1) \$25.35
- (2) \$32.05
- (3) \$33.25
- (4) \$35.40

()

14. Six similar laptops and three similar radios were packed into similar boxes. Four laptops and two radios when packed into a box weighed $10\frac{1}{4}$ kg. Two laptops and a radio when packed into a box weighed $5\frac{1}{4}$ kg. What is the mass of the empty box?

- (1) $\frac{1}{4}$ kg
(2) 5 kg
(3) $5\frac{1}{4}$ kg
(4) $15\frac{1}{2}$ kg

()

15. Given that all the lines meet at right angles. What is the perimeter of the figure?

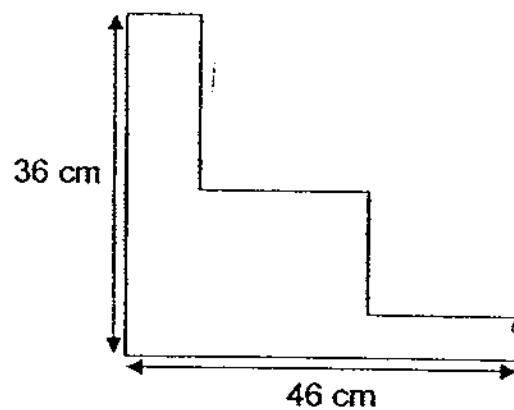

- (1) 82 cm
(2) 118 cm
(3) 164 cm
(4) 128 cm

()

Name: _____ ()

Class: Pr 4

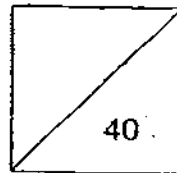

Section B: (20 x 2 marks = 40 marks)

Read the questions carefully and write the correct answer in the boxes provided.
Show all workings clearly.

16. Subtract 364 from 4912.

17. Find the value of $8416 \div 8$.

18. What fraction of the figure below is shaded?

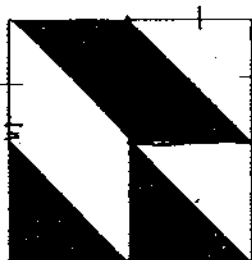

19. Arrange the following fractions from the smallest to the greatest.

$$\frac{5}{6}, \frac{4}{5}, \frac{11}{12}$$

The line graph below shows the daily sales of sticks of chicken nuggets over a week. Study the graph carefully and answer the questions 20 and 21.

Daily Sales of Sticks of Chicken Nuggets over a Week

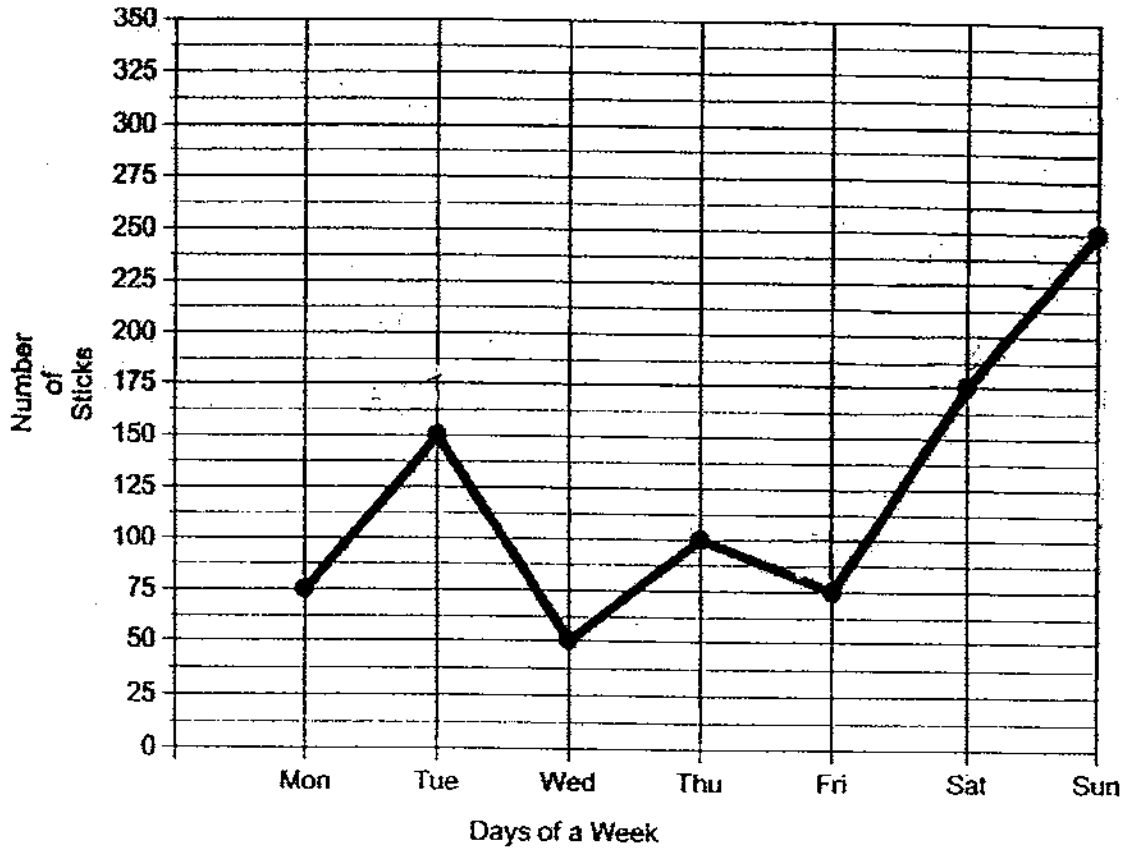

20. What is the most number of sticks of chicken nuggets sold ^{in a single day} within the week?

21. Between which 2 days did the sales increase the most?

22. Measure and write down the size of $\angle x$.

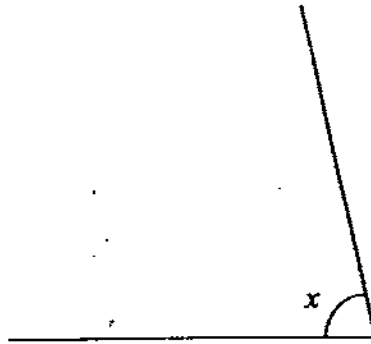

23. In the figure, ABCD is a rectangle. Find the value of $\angle x$.

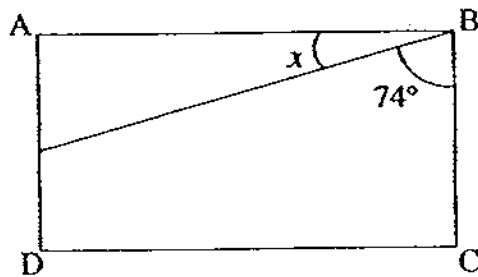

24. How many seconds does it take the second hand of a clock to make a three-quarter turn around the clock?

25. A show ended at 00 25. The show lasted for 2 h 55 min. At what time did the show start? Write the time in 24-hour clock.

26. Find the value of $10.1 - 0.84$.

27. The graph shows the number of families with pets.

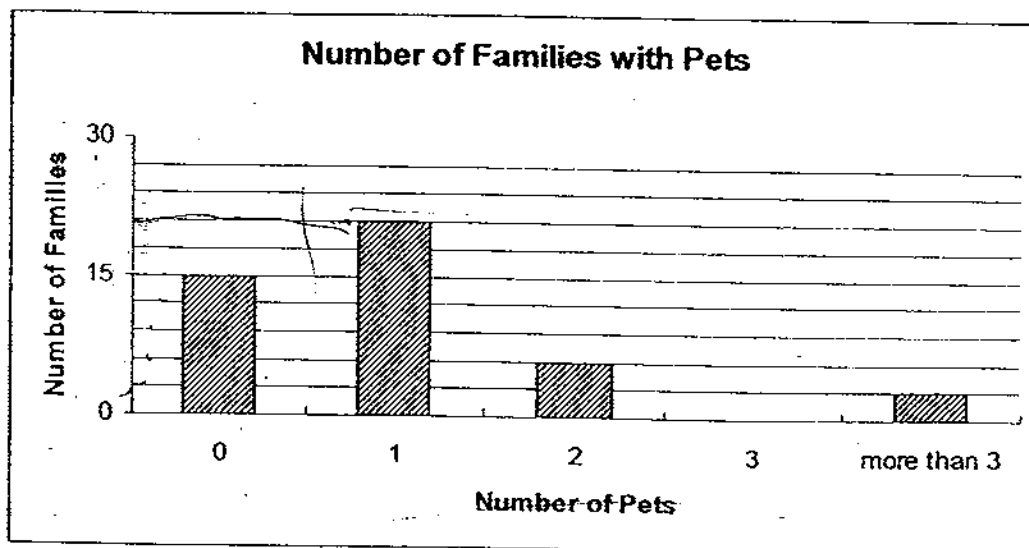

How many families have at least 1 pet?

28. In the figure, one of the angles is a right angle. Name the angle.

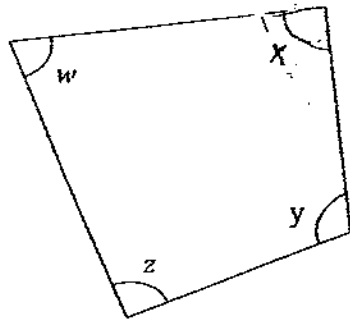

29. Shade 2 more unit squares to make the figure symmetrical.

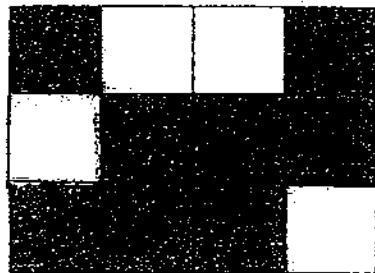

30. Jennifer used buttons of 4 different shapes to form a pattern. The first 15 buttons are shown below. What was the shape of the 56th button? Draw the shape.

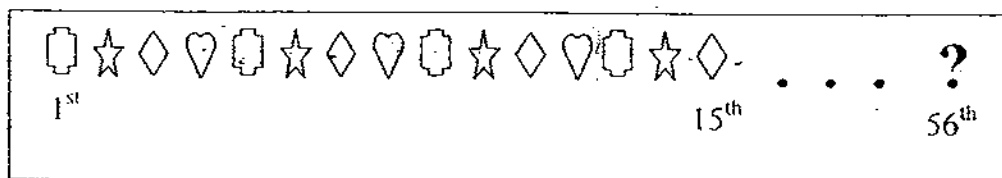

31. The difference between two fractions is $\frac{1}{3}$. If the smaller fraction is $\frac{3}{4}$, what is the sum of the two fractions? Leave your answer as a mixed number.

32. Jamie's mass is 50.9 kg when rounded off to 1 decimal place. What is her largest possible mass? Leave your answer in 2 decimal places.

 kg

33. The area of Square X is 64 cm^2 and the area of Square Z is 25 cm^2 . Find the perimeter of the unshaded part Y.

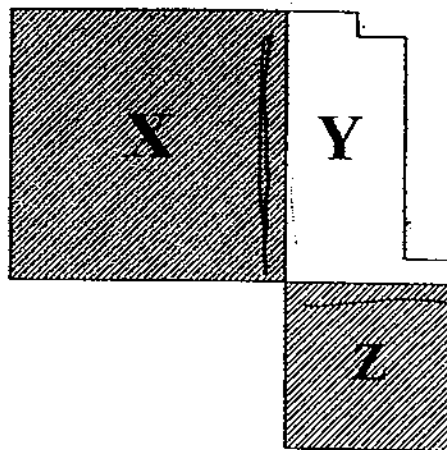
 cm

34. Study the figures carefully. Which figure has the greatest perimeter? Each is of the same size.

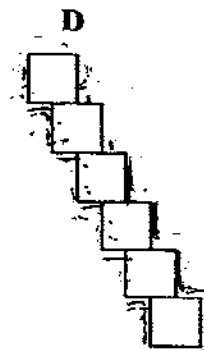
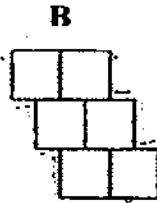

35. Look at the number pattern below. What is the missing number in the box?

2, 5, 11, , 32

Name: _____ ()

Class: Pr 4 _____

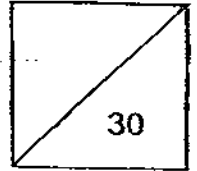

Section C: (30 marks)

Read the following problem sums carefully. You may draw models to help you. Show all workings clearly in the spaces provided.

36. A tank when filled with sand has a mass of 23 kg. When $\frac{1}{5}$ of the tank was filled with sand, its mass is 5 kg. What is the mass of the tank when empty?
(3 marks)

Working

37. $\frac{1}{3}$ of the pupils in the class wanted to go Japan. $\frac{1}{4}$ of the pupils in the class wanted to go Korea. $\frac{1}{6}$ of the pupils in the class wanted to go Thailand and the rest wanted to go Malaysia. There were 3 more pupils who wanted to go Malaysia than Thailand. Find the total number of pupils in the class. (3 marks)

Working

38. Mary and Jenny saved a total of \$1000. After paying \$250 for a watch, Jenny found that she had \$400 less than Mary. How much did Mary save at first? (4 marks)

Working

39. Jasmine had \$80. She bought 2 pairs of earrings at \$24.50 each and spent part of the remaining money on 5 towels. If she had \$5.50 left, how much did each towel cost? (4 marks)

Working

40. Anna paid \$85.10 for a total of 10 brownies and pies. She had 2 more brownies than pies. Each pie cost \$8.90 more than each brownie. How much did she pay for one pie? (4 marks)

Working

41. The figure below is made up of a square and 2 identical rectangles.

- a) Find the length of AH. (1 mark)
- b) Find the area of the figure. (3 marks)

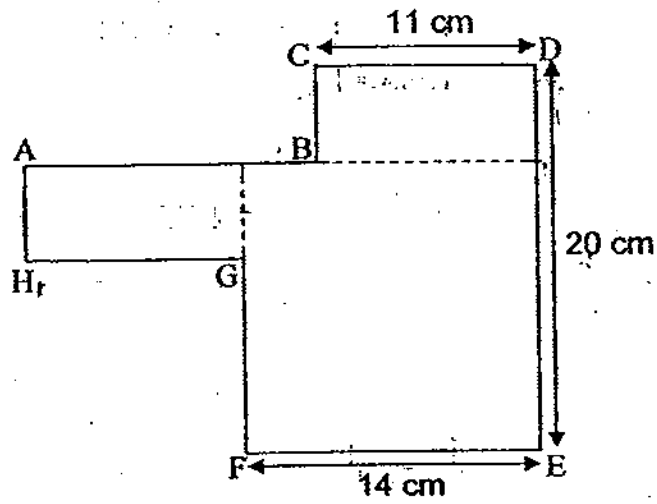

Working

42. John wanted to place a square-shaped carpet in his square-shaped room as shown below. The area of the uncovered part is 24 m^2 . The sides of both squares are whole numbers.

- a) Find the length of the carpet. (3 marks)
- b) The square-shaped carpet has a unique strip of dotted design as shown. Find the area of floor covered by the strip of dotted design of the carpet only. (1 mark)

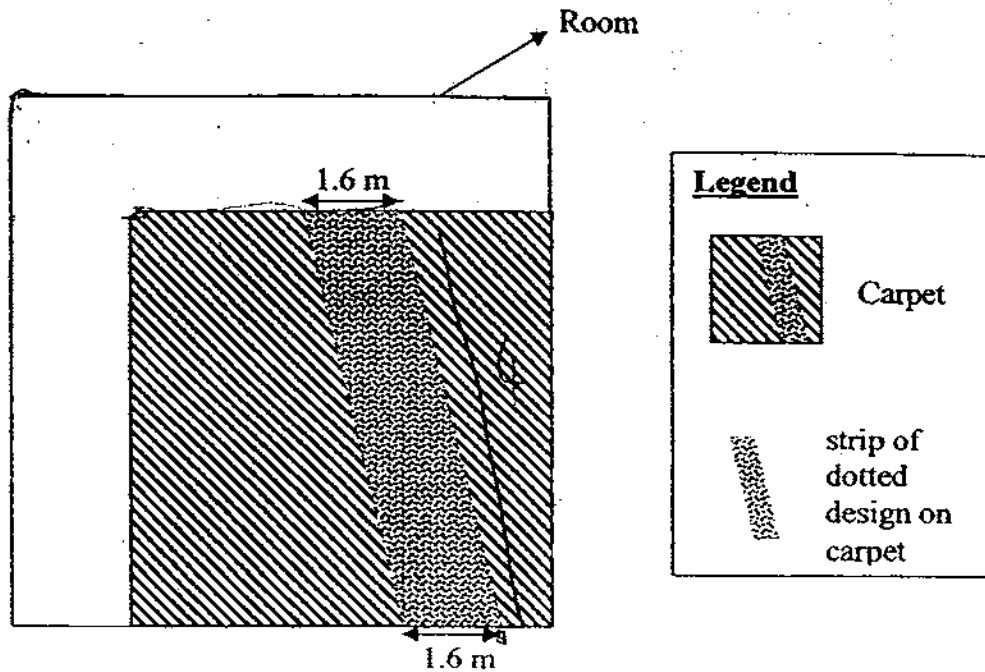

Working

43. The number of girls in a school was $\frac{2}{5}$ of the number of pupils in the school.

There were 48 more boys than girls. After some girls went for a camp, the number of boys in the school was 4 times the number of the remaining girls.

How many girls went camping? (4 marks)

Working

-END OF PAPER-

Setter:

Ms. Eunice Chua



ANSWER SHEET

EXAM PAPER 2009

SCHOOL : HENRY PARK PRIMARY
SUBJECT : PRIMARY 4 MATHEMATICS

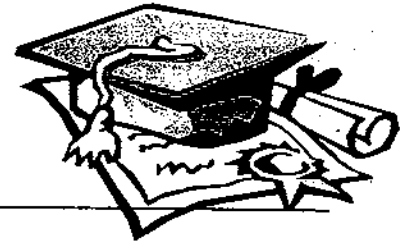

TERM : SA2



Q1	Q2	Q3	Q4	Q5	Q6	Q7	Q8	Q9	Q10	Q11	Q12	Q13	Q14	Q15
4	3	3	1	2	2	2	3	1	3	3	2	4	1	3

16)4548 17)1052 18) $\frac{1}{2}$ 19) $\frac{4}{5}, \frac{5}{6}, \frac{11}{12}$ 20)250

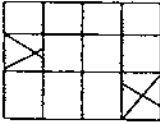
21)Friday and Saturday 22) 78° 23) 16° 24)45s 25)2130

26)9.26 27)30 28) $\angle X$ 29)  30) 

31) $1\frac{5}{6}$ 32)50.94kg

33)26cm 34)D 35)20

36)23kg-5kg=18kg
 $18\text{kg} \div 4 = 4.5\text{kg}$
 $5\text{kg} - 4.5\text{kg} = 0.5\text{kg}$
 The mass of the tank is 0.5kg

37) $3 \times 12 = 36$
 The total number of pupils in the class is 36

38) $\$1000 - \$250 = \$750$
 $\$750 - \$400 = \$350$
 $\$350 \div 2 = \175
 $\$175 + \$400 = \$575$

39) $\$24.50 \times 2 = \49
 $\$80 - \$49 = \$31$
 $\$31 - \$5.5 = \$25.50$
 $\$25.50 \div 5 = \5.10
 Each towel cost \$5.10

40) $\$8.90 \times 4 = \35.60

$\$85.10 - \$35.60 = \$49.50$

$\$49.50 \div 10 = \4.95

$\$4.95 + \$8.90 = \$13.85$

She paid \$13.85 for one pie.

41)a) $20\text{cm} - 14\text{cm} = 6\text{cm}$

The length of AH is 6cm.

b) $14\text{cm} \times 14\text{cm} = 196\text{cm}^2$

$11\text{cm} \times 6\text{cm} = 66\text{cm}^2$

$196\text{cm}^2 + 66\text{cm}^2 = 262\text{cm}^2$

The area is 262cm^2

42)a) $49 - 25 = 24$

$25 = 5 \times 5$

The length is 5m

b) $1.6 \times 5 = 8\text{m}^2$

43) $3 \text{ units} - 2 \text{ units} = 1 \text{ unit}$

$1 \text{ unit} = 48$

$48 \times 3 = 144$

$48 \times 2 = 96$

$144 \div 4 = 36$

$96 - 36 = 60$

60 girls went camp