



AI TONG SCHOOL

2008

SEMESTRAL ASSESSMENT 2

PRIMARY 4

MATHEMATICS

DURATION : 1 h 45 min

DATE : 23 October 2008

INSTRUCTIONS

Do not open the booklet until you are told to do so.

Follow all instructions.

Answer all questions.

Name : _____ ()

Class : Primary 4 _____

Marks:

100

Parent's Signature : _____

Date : _____

Section A

Questions 1 to 14 carry 2 marks each.

For each question, four options are given. One of them is the correct answer.

Make your choice (1, 2, 3 or 4). Shade the oval (1, 2, 3 or 4) on the Optical Answer Sheet with a 2B pencil. (28 marks)

1. What is the value of the digit 9 in 97 304?

- (1) 90 000
- (2) 9000
- (3) 900
- (4) 90

2. Which of the following is a multiple of both 7 and 9?

- (1) 16
- (2) 18
- (3) 36
- (4) 63

3. The figure below is not drawn to scale, ABCD is a square with $AE = EB = DF = FC$.



What fraction of ABCD is shaded?

- (1) $\frac{1}{3}$
- (2) $\frac{2}{5}$
- (3) $\frac{1}{4}$
- (4) $\frac{1}{2}$

4. Arrange the following fractions from the greatest to the smallest.

$$\frac{1}{4}, \frac{2}{3}, \frac{5}{12}$$

(greatest)

(smallest)

(1) $\frac{1}{4}, \frac{5}{12}, \frac{2}{3}$

(2) $\frac{2}{3}, \frac{5}{12}, \frac{1}{4}$

(3) $\frac{2}{3}, \frac{1}{4}, \frac{5}{12}$

(4) $\frac{5}{12}, \frac{2}{3}, \frac{1}{4}$

5. $8.07 = 8 + \frac{7}{\boxed{?}}$

What is the missing number in the box?

- (1) 1
(2) 10
(3) 100
(4) 1000

6. Write $2\frac{4}{25}$ as a decimal.

- (1) 2.42
(2) 2.40
(3) 2.16
(4) 2.016

7. A rectangle has a perimeter of 56 cm. Its breadth is 8 cm. What is its length?

- (1) 20 cm
- (2) 28 cm
- (3) 40 cm
- (4) 48 cm

8. The figure below is not drawn to scale. Find the perimeter of the figure.

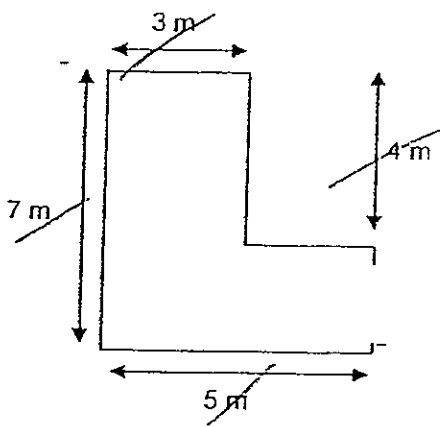

- (1) 19 m
- (2) 21 m
- (3) 22 m
- (4) 24 m

The following table shows the favourite activities of 40 boys and girls at a funfair. Study the table carefully and answer Questions 9 and 10.

Games	Boys	Girls
Merry-Go-Round	?	7
Bumper Car	10	3
Viking	8	8
Total	?	?

9. How many boys are there altogether?

- (1) 18
- (2) 22
- (3) 33
- (4) 40

10. How many boys enjoy taking the Merry-Go-Round?

- (1) 33
- (2) 22
- (3) 3
- (4) 4

11. A cinema has 360 seats. 3 out of every 5 seats are occupied. How many seats are occupied?

- (1) 72
- (2) 120
- (3) 144
- (4) 216

12. How many lines of symmetry are there in the figure below?

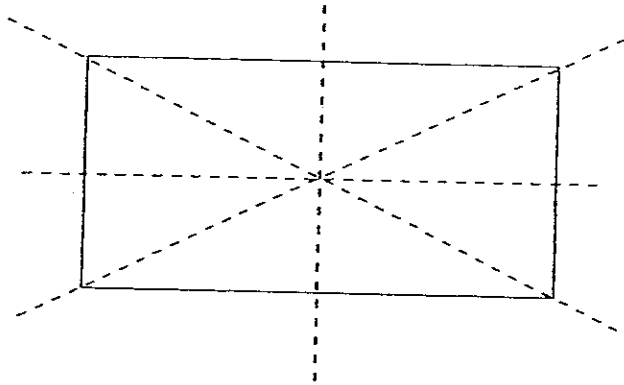

- (1) 1
- (2) 2
- (3) 3
- (4) 4

13. Mr Raj left his home at 06 30. He returned home at 14 45 on the same day. How long was he away from home?

- (1) 8 h 45 min
- (2) 8 h 15 min
- (3) 7 h 15 min
- (4) 6 h 30 min

14. Wayne had \$14 more than Zan. After their father gave each of them \$8, both of them had \$60 altogether. How much money did Zan have at first?

- (1) \$15
- (2) \$23
- (3) \$30
- (4) \$46

Name : _____

Class : _____

Section B

Questions 15 to 34 carry 2 marks each. Write your answers in the spaces provided.
For questions which require units, give your answers in the units stated.

(40 marks)

15. Fill in the blanks with the correct number in the number pattern below.

850 , 820 , 790, _____ , 730

Ans: _____

16. Find the value of 4018×7 .

Ans: _____

17. Round off 64 630 to the nearest hundred.

Ans: _____

18. Write $\frac{21}{5}$ as a mixed number in its simplest form.

Ans: _____

19. Find the value of $\frac{2}{9} + \frac{2}{3}$.

Ans: _____

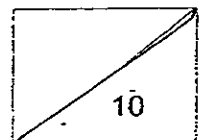

20. In the figure below, not drawn to scale, ABCD is a rectangle. Find $\angle x$.

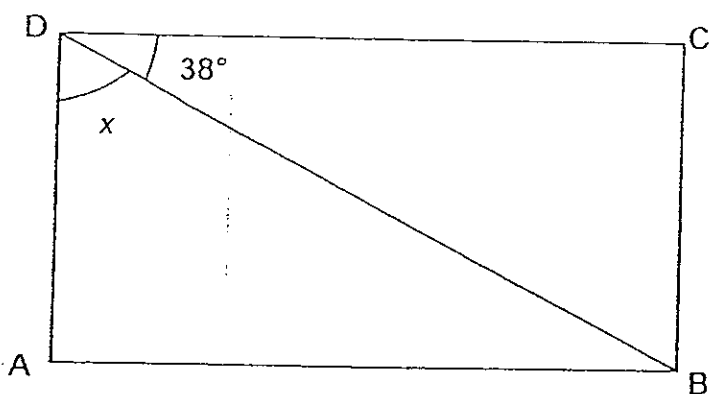

Ans: _____

21. Name the pair of parallel lines in the figure below.

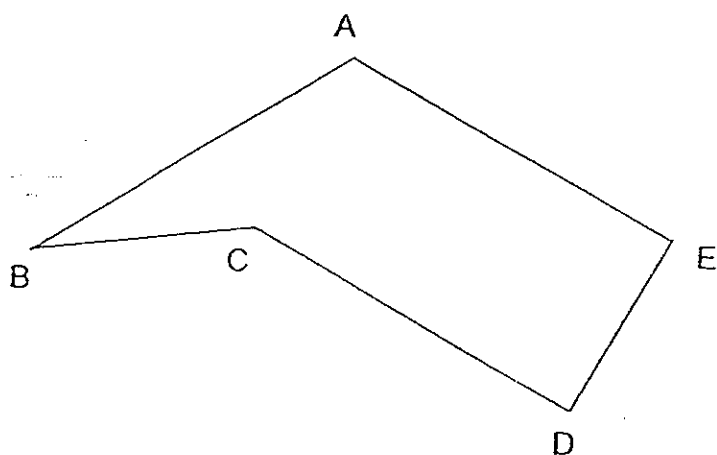

Ans: _____ // _____

22. Find the value of 6.43×8 .

Ans: _____

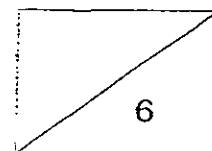

23. $16.2 - 4.39 =$ _____

Ans: _____

24. Tim, Gary and Ada spend \$1680 altogether. Tim spends half of what Gary spends. Gary spends twice as much as Ada. How much money does Gary spend?

Ans: \$ _____

25. The figure below is not drawn to scale. Find $\angle b$.

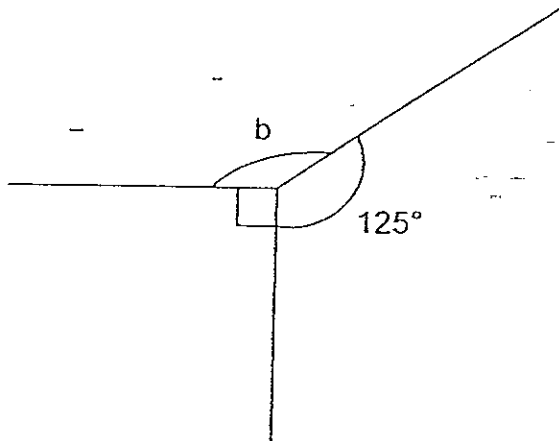

Ans: _____

26. Colour or shade **one unit shape** in the figure below.

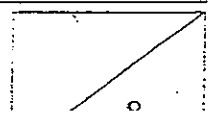
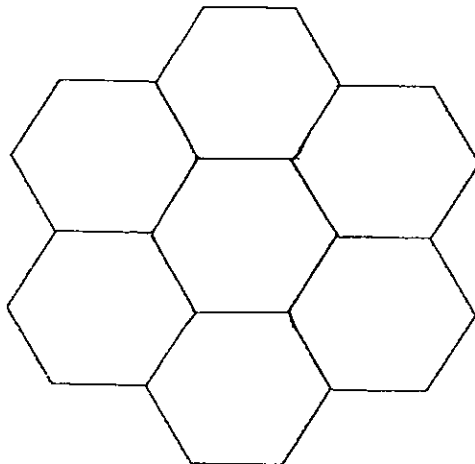

27. Shade two more squares to complete the figure which has the dotted line XY as a line of symmetry.

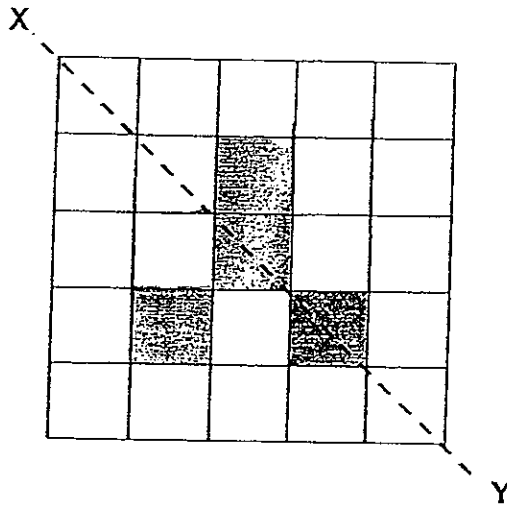

28. Joyce saved \$15 in the first month, \$30 in the second month, \$45 in the third month, and so forth. Following this pattern, the amount of money she saved in the last month was \$120. How much money did Joyce save in all?

Ans: \$ _____

29. May spent \$40 on a T-shirt and had $\frac{3}{8}$ of her money left. How much money did she have at first?

Ans: \$ _____

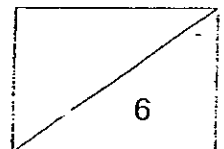

30. A movie started at 10.30 a.m. The movie lasted 2 hours and 15 minutes. What time did the movie end?

Ans: _____ p.m.

31. Jenny paid \$107.60 for 4 pizzas. How much did each pizza cost?

Ans: \$ _____

32. The figure is made up of identical squares. Each square has a side of 4 cm.
Find the **perimeter** of the figure.

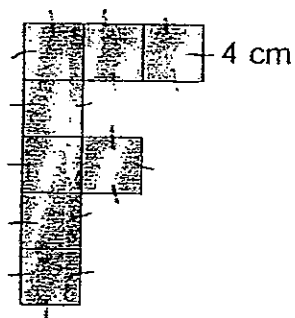

Ans: _____ cm

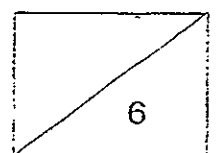

The line graph below shows the amount of water used by the Tan family from January to June. Study the graph and answer questions 33 and 34.

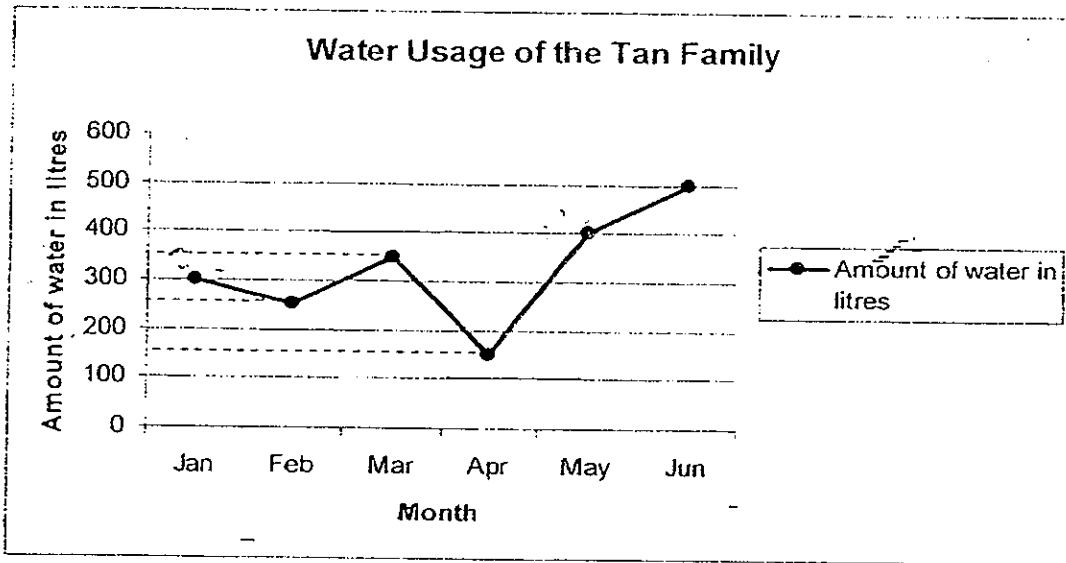

33. In which month did the Tan family use the least amount of water?

Ans: _____

34. How much more water did the Tan family use in June than in February?
Give your answer in litres.

Ans: _____ l

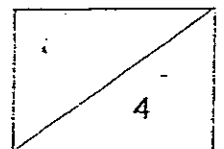

Section C

Questions 35 to 38 carry 3 marks each. Questions 39 to 43 carry 4 marks each. Show your working clearly in the space provided below each question and write your answers in the spaces provided. (32 marks)

35. The figure below is not drawn to scale. PQ and MN are straight lines. Find $\angle x$.

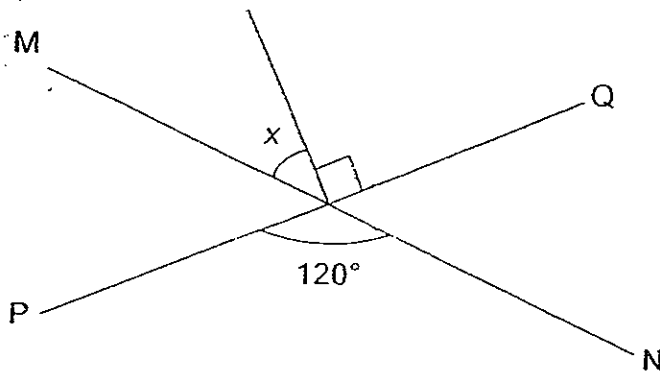

Ans: _____ [3]

36. 2 identical watches and 5 similar handphones cost \$3240 altogether. If a watch cost twice as much as a handphone, find the total cost of 1 watch and 1 handphone.

Ans: _____ [3]

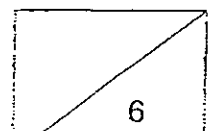

37. Jennifer bought 5 kg of flour. She gave 0.24 kg of it to her neighbour and used the rest to bake 7 similar cakes. How much flour did she use for each cake?
(Give your answer in kg)

Ans: _____ [3]

-
38. A tank is $\frac{1}{3}$ full. After 6 l of water was added into the tank, it was $\frac{7}{12}$ full.

Find the capacity of the tank.

Ans: _____ [3]

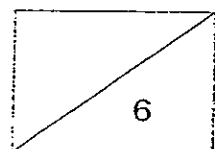

39. Betty had \$320 at first. She spent $\frac{5}{8}$ of her money at the bookshop and $\frac{1}{4}$ of it at the supermarket.

- (a) What fraction of her money was spent?
- (b) How much had she left?

Ans : (a) _____ [2]

(b) _____ [-2]

40. Mr Low took a plane from Singapore to Shanghai. He boarded the plane on Saturday at 23 50. The flight was $5\frac{1}{4}$ hours.

- (a) On what day did he arrive at Shanghai?
- (b) What time did he arrive at Shanghai?

Ans : (a) _____ [1]

(b) _____ [3]

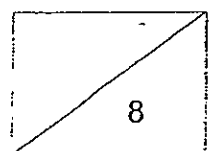

41. Jin Jin pasted a rectangular picture on a cardboard measuring 60 cm by 45 cm. He left a 2 cm border all around the picture. What is the area of the cardboard **not** covered by the picture?

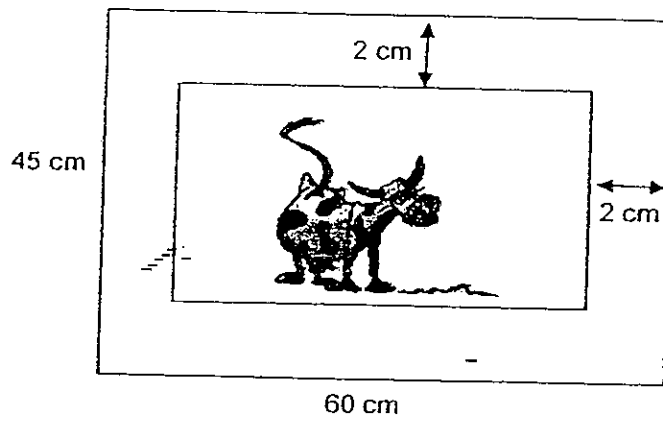

Ans: _____ [4]

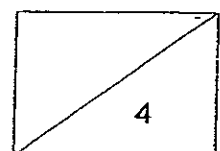

42. Josh spent \$24 on Monday, \$14.60 on Tuesday and \$12.80 each day from Wednesday to Friday. How much did he have left if he had \$150 at first?

Ans: _____ [4]

43. Jiajia has 30 pieces of \$2 and \$5 notes altogether. The total value of the money she has is \$135. Find the number of pieces of \$2 notes and the number of pieces of \$5 notes that Jiajia has.

Ans : Number of \$2 notes = _____

Number of \$5 notes = _____ [4]

End-of-paper

Please check your work carefully.

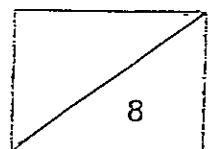



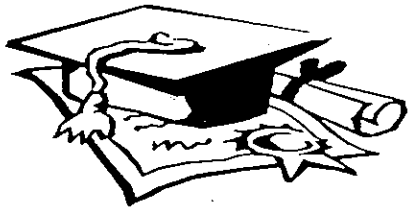

ANSWER SHEET

EXAM PAPER 2008

SCHOOL : AITONG PRIMARY SCHOOL
SUBJECT : PRIMARY 4 MATHEMATICS

TERM : SA 2

Q1	Q2	Q3	Q4	Q5	Q6	Q7	Q8	Q9	Q10	Q11	Q12	Q13	Q14
1	4	3	2	3	3	1	4	2	4	4	2	2	1

15) 760

16) 28126

17) 64600

18) $4\frac{1}{5}$

19) $\frac{8}{9}$

20) 52°

21) CD//AE

22) 51.44

23) 11.81

24) \$8.40

25) 145

26)

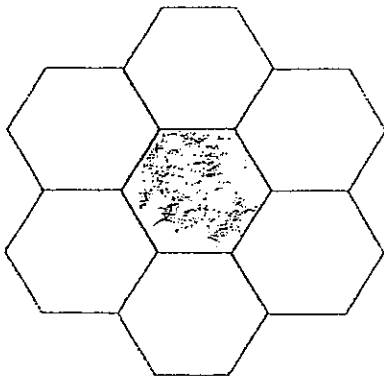

27)

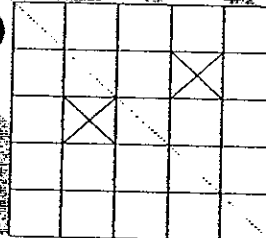

28) \$500

29) \$64

30) 12:45 p.m.

31) \$26.90

32) 72cm

33) April

34) 250L

35) $180^\circ - 120^\circ = 60^\circ$

$60^\circ + 90^\circ = 150^\circ$

$180^\circ - 150^\circ = 30^\circ$

$\angle X$ is 30°

36) 1 unit \rightarrow $\$3240 \div 9 = \360

3 units \rightarrow $\$360 \times 3 = \1080

The total cost is \$1080

37) $5000\text{g} - 0.24 = 4.76\text{kg}$

$4.76\text{kg} \div 7 = 680\text{g}$

He used 0.80g for each cake.

38) $6 \div 3 = 2\text{L}$

$2 \times 12 = 24$

The capacity of the tank is 36L

39) a) $\frac{5}{8} + \frac{2}{8} = \frac{7}{8}$

$\frac{7}{8}$ of her money was spent.

b) $\$320 \div 8 = \40

She had left \$40

40) a) $2350 + 5\text{h} = 0450$

$0450 + 15\text{min} = 0505$

He arrive at Shanghai at Sunday.

b) He arrived at Shanghai at 0505.

41) $45 - 4 = 41\text{cm}$

$60 - 4 = 56\text{cm}$

$56 \times 41 = 2296\text{cm}^2$

$45 \times 60 = 2700\text{cm}^2$

$2700 - 2296 = 404\text{cm}^2$

The area is 404cm^2

42) $\$12.80 \times 3 = \38.40

$\$24 + \$38.40 + \$14.60 = \77

$\$150 - \$77 = \$73$

He had left \$73

43) Jia Jia had 5 \$2 notes and 25 \$5 notes.