

SA1

SINGAPORE CHINESE GIRLS' SCHOOL

FIRST SEMESTRAL ASSESSMENT 2015

PRIMARY 4

MATHEMATICS

BOOKLET A

Name :

Parent's Signature

There are 15 questions in this booklet.
SECTION A

Total Time : 1 h 45 min (Booklet A and B)

INSTRUCTIONS TO CANDIDATES

DO NOT OPEN THIS BOOKLET UNTIL YOU ARE TOLD TO DO SO.

FOLLOW ALL INSTRUCTIONS CAREFULLY.

ANSWER ALL QUESTIONS.

CHECK THAT ALL MCQ ANSWERS ARE SHADED CORRECTLY IN THE OAS

This question paper consists of 7 printed pages. (Inclusive of cover page)

Section A: (30 marks)

Questions 1 to 15 carry 2 marks each. For each question, four options are given. One of them is the correct answer. Make your choice (1, 2, 3 or 4). Shade the correct oval (1, 2, 3 or 4) on the Optical Answer Sheet.

1. Which number below is 100 more than 2789?

- (1) 2689
- (2) 2799
- (3) 2889
- (4) 3789

2. $62\,405 = 60\,000 + \underline{\hspace{2cm}} + 400 + 5$

- (1) 200
- (2) 2
- (3) 2000
- (4) 20 000

3. Find the sum of the first 3 multiples of 4.

- (1) 7
- (2) 12
- (3) 24
- (4) 40

4. A number when rounded off to the nearest 100 is 3900. The smallest possible whole number is _____.

- (1) 3840
- (2) 3850
- (3) 3910
- (4) 3950

5. 6 is a common factor of _____.

- (1) 2 and 3
- (2) 12 and 32
- (3) 16 and 26
- (4) 24 and 30

W H F E

6.

Which one of the following letters does not have perpendicular lines in it?

- (1) W
- (2) H
- (3) F
- (4) E

7. In the figure below, how many lines are parallel to line AB?

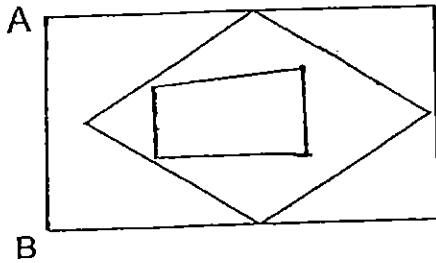

- (1) 1
- (2) 2
- (3) 3
- (4) 4

8. $\frac{1}{4} + \frac{1}{3} = \square$

(1) $\frac{1}{12}$

(2) $\frac{1}{7}$

(3) $\frac{2}{7}$

(4) $\frac{7}{12}$

9. The difference between $6\frac{1}{3}$ and $\frac{4}{9}$ is _____.

(1) $5\frac{8}{9}$

(2) $6\frac{1}{9}$

(3) $6\frac{3}{6}$

(4) $6\frac{7}{9}$

10. There are 50 spectators in the stadium. $\frac{1}{5}$ of them are boys and $\frac{1}{2}$ of them are girls and the rest are adults. How many adults are there?

(1) 10

(2) 15

(3) 25

(4) 35

11. The length of a rectangular room is 14 m. Its breadth is half its length. Find the area of the rectangular room.

- (1) 7 m²
- (2) 42 m²
- (3) 49 m²
- (4) 98 m²

12. Melissa is facing the lift. She turns 135° in a clockwise direction. What will she be facing now?

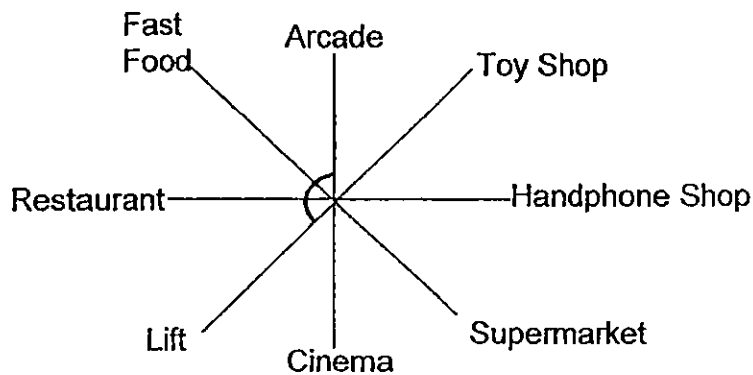

- (1) Arcade
- (2) Handphone Shop
- (3) Fast Food
- (4) Toy Shop

13. Sweets are sold in packets of 8. Jenny wants to give 2 sweets each to 33 children. How many packets of sweets should she buy?

- (1) 8
- (2) 9
- (3) 41
- (4) 66

14. The total cost of a smartphone and a tablet is \$1300. The tablet costs \$340 more than the smartphone. What is the cost of the smart phone?

- (1) \$140
- (2) \$480
- (3) \$820
- (4) \$960

15. Find the missing number in the number pattern below.

1, 4, 9, 16, , 36

- (1) 23
- (2) 24
- (3) 25
- (4) 26

SINGAPORE CHINESE GIRLS' SCHOOL

FIRST SEMESTRAL ASSESSMENT 2015

PRIMARY 4

MATHEMATICS

BOOKLET B

Name :

Class :

		Marks attained	Max Mark
Booklet A	Section A		30
Booklet B	Section B		40
	Section C		30
Total			100

Parent's Signature

There are 28 questions in this booklet.
SECTION B and C

Total Time : 1 h 45 min (Booklet A and B)

INSTRUCTIONS TO CANDIDATES

DO NOT OPEN THIS BOOKLET UNTIL YOU ARE TOLD TO DO SO.
FOLLOW ALL INSTRUCTIONS CAREFULLY.
ANSWER ALL QUESTIONS.

This question paper consists of 13 printed pages. (Inclusive of cover page)

Section B: (40 marks)

Questions 16 to 35 carry 2 marks each. Write your answers in the spaces provided. For questions which require units, give your answers in the units stated.

Do not write
in this column

16. What is the second common multiple of 4 and 8?

Ans : _____

17. Arrange the numbers below in order, beginning with the greatest.

23 369 , 36 892 , 23 396 , 38 692

_____	,	_____	,	_____	,	_____
Greatest						Smallest

18. How many quarters are there in 4 wholes?

Ans :

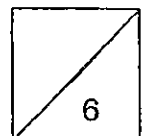

19.

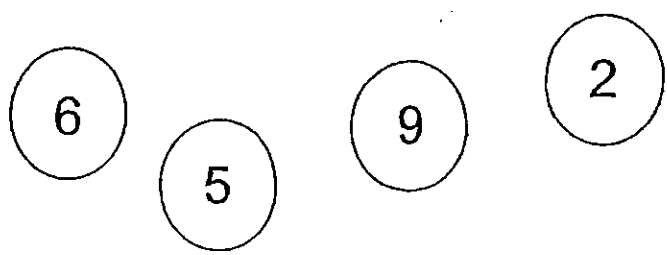

Arrange these numbers to form the greatest 4-digit **odd** number.

Ans : _____

20. The figure below is not drawn to scale. It is a square. Find the sum of the value of $\angle x$ and $\angle y$.

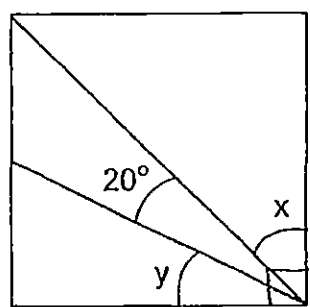

Ans : _____^o

21. A travel fair drew 96 000 people on the first day. Half of that number visited the travel fair on the second day. Find the number of people that visited the travel fair on both days.

Ans : _____

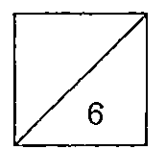

22. Using a protractor, label and draw an angle of 55° such that $\angle AOB = 55^\circ$.

Do not write
in this column

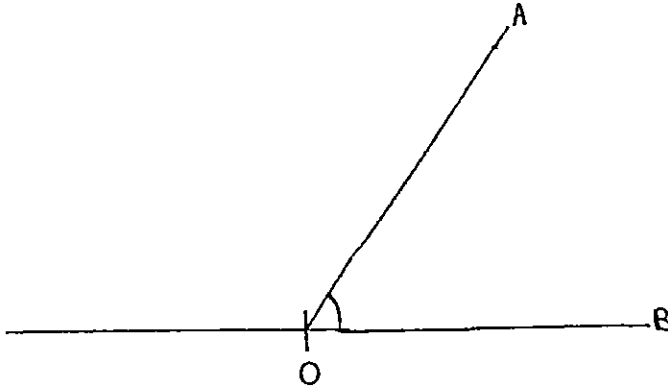

23. PQRS is a square of side 11 cm. The triangle has an area of 45 cm^2 . What is the area of the shaded part?

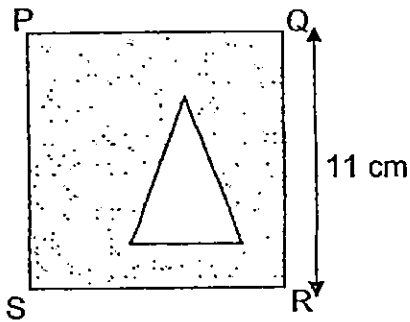

Ans : _____ cm^2

24. Measure $\angle XYZ$.

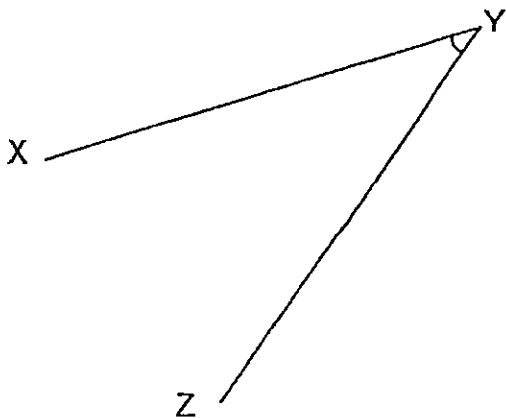

Ans : _____ $^\circ$

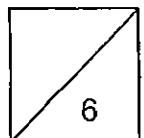

25: How many pairs of perpendicular lines are there in the figure?

Do not write
in this column

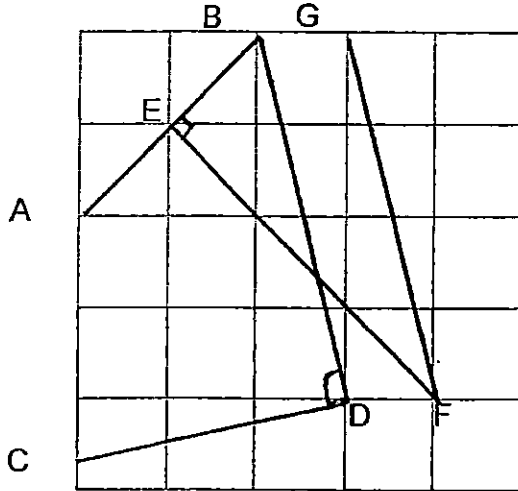

Ans : _____

26. Find the value of $\frac{5}{12} \times 3$. Express your answer in the simplest form.

Ans : _____

27. The figure, not drawn to scale, is made up of 9 small squares. How many more squares must be shaded so that $\frac{2}{3}$ of the figure is shaded?

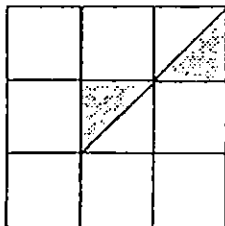

Ans : _____

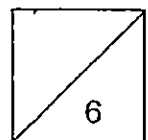

28. $\frac{1}{2} + \frac{1}{4} + \frac{3}{4} = \square$ Express your answer in the simplest form.

Do not write
in this column

Ans _____

29. The figure is not drawn to scale. It is made up of 2 rectangles, ABCG and EFGD. The line DC is equal to the line DE. What is the total area of the figure as shown below.

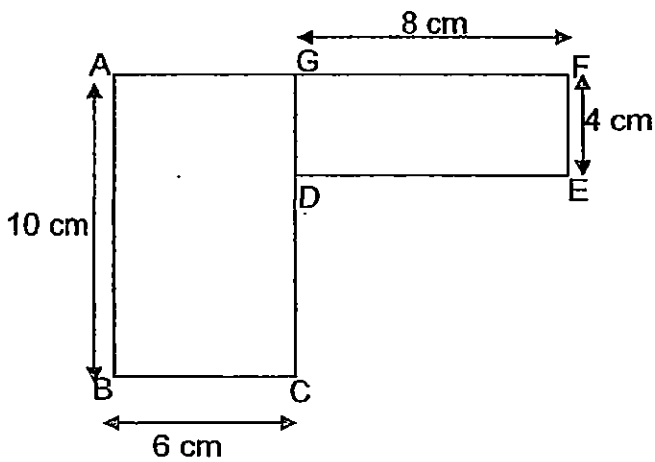

Ans: _____ cm²

30. Regina has \$146. Her parents give her \$54 more. If Regina saves $\frac{3}{10}$ of her money, how much money did she save?

Ans : \$ _____

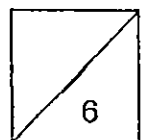

31. Marvin had a piece of cloth measuring 20 cm by 9 cm. He wanted to cut out smaller squares measuring 3 cm by 3 cm from it. What is the maximum number of smaller squares that can be cut from the piece of cloth?

Do not write
in this column

Ans : _____

32. The following figure shows 4 rectangles inside square ABCD. The length of DC is 8 cm. Find the length of DF.

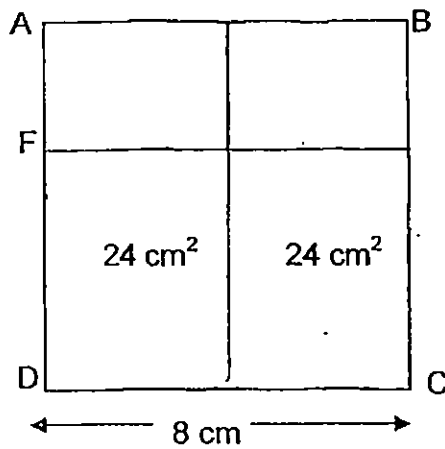

Ans : _____ cm

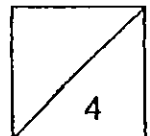

33. Three identical squares are used to form the figure below. The area of each identical square is 16 cm^2 . Find the perimeter of the figure.

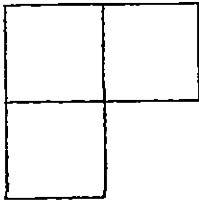

Ans: _____ cm

34. Nicki is 9 years older than Johnny.
11 years ago, the sum of their age was 63.
How old is Johnny now?

Ans : _____

35. A group of children lined up in 8 rows in the field for morning assembly. There was equal number of children in each row. Royston was in one of the rows. In his row, he was fifth from the front and third from the back. How many children were there in the field altogether?

Ans : _____

Do not write
in this column

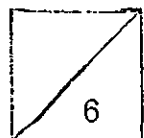

Section C: (30 marks)

For questions 36 to 43, show your working clearly in the space provided for each question and write your answer in the space provided. The number of marks available is shown in brackets [] at the end of each question or part-question.

Do not write
in this column

-
36. 814 people attended a concert. There were 278 children. There were 136 more women than men. How many men were there?

Ans: _____ [3]

-
37. Fiona spent $\frac{1}{5}$ of her money on a dress and \$39 on a bag. If she had \$121 left, how much money did she have at first?

Ans: _____ [3]

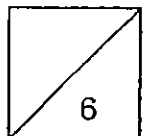

Do not write
in this column

- 38 A watch cost \$20 more than a pair of shoes. Mrs Tan bought 2 watches and 3 pairs of shoes. The total amount spent is \$550. What is the cost of a watch and a pair of shoes?

Ans: _____ [4]

-
39. There are 9 containers and 8 packets of sweets. There are 291 sweets in total. Each packet contains 15 sweets. How many sweets are there in each container?

Ans: _____ [4]

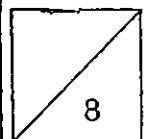

40. Raymond had \$350. If he spent \$50 on books and some of his money on bags, he would be left with $\frac{3}{5}$ of his money. How much did he spend on bags?

Ans: _____ [4]

-
41. $\frac{1}{3}$ of the animals on a farm were ducks. $\frac{1}{4}$ of them were geese and the rest were chickens. There were 1200 ducks, geese and chickens altogether. How many more chickens than geese are there in the farm?

Ans: _____ [4]

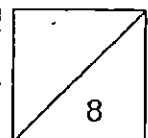

42. Tom had 215 more stickers than Ahmad at first. Then Tom bought 55 more stickers. In the end, Tom has 3 times as many stickers as Ahmad.

(a) How many stickers did Ahmad have?

(b) Find the total number of stickers Tom and Ahmad had in the end?

Do not write
in this column

Ans: (a) _____ [2]

(b) _____ [2]

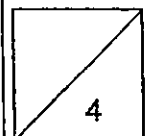

Do not write
in this column

43. Alex, Sandy and Zara bought identical handphone covers and pouches. Alex bought 4 handphone covers and 2 pouches. Sandy bought 1 handphone cover and 2 pouches. Zara bought 1 pouch. Sandy spent \$20 more than Zara. How much did the 3 people spend in total?

Ans: _____ [4]

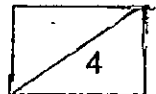

END



EXAM PAPER 2015

LEVEL : PRIMARY 4

SCHOOL : SINGAPORE CHINESE GIRLS

SUBJECT : MATH

TERM : SA1

Q1	Q2	Q3	Q4	Q5	Q6	Q7	Q8	Q9	Q10
3	3	3	2	4	1	3	4	1	2
Q11	Q12	Q13	Q14	Q15					
4	1	2	2	3					

Q16. 16 **Q17.** 38692 (Greatest), 36892, 23396, 23369 (Smallest)

Q18. 16 **Q19.** 9625 **Q20.** 70

Q21. 14 4000 $\Rightarrow 96000 \div 2 = 48000, 96000 + 48000 = 144000$

Q22. SEE PICTURE

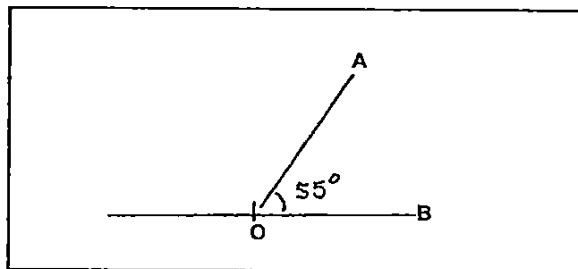

Q23. 76. \Rightarrow square - $11 \times 11 = 121, 121 - 45 = 76\text{cm}^2$

Q24. 38°

Q25. 2

Q26. $1\frac{1}{4} \Rightarrow \frac{5}{12} \times 3 = \frac{15}{12} = 1\frac{1}{4}$

Q27. $5 \Rightarrow \frac{6}{9} - \frac{1}{9} = \frac{5}{9}$

Q28. $1\frac{1}{2} \Rightarrow \frac{6}{4} = 1\frac{2}{4} = 1\frac{1}{2}$

Q29. $92\text{cm}^2 \Rightarrow 6 \times 10 = 60, 8 \times 4 = 32, 60 + 32 = 92$

Q30. \$60 $\Rightarrow 146 + 54 = 200, 100 - 200, 1U \Rightarrow 200 \div 10 = 20, 3U \Rightarrow 20 \times 3 = 60$

Q31. 18 $\Rightarrow 9 \div 3 = 3, 20 \div 3 = 6\frac{2}{3}, 3 \times 6 = 18$

Q32. 6cm $\Rightarrow 24 \div 4 = 6$

Q33. 32cm $\Rightarrow 4 \times 8 = 32$

Q34. 38 years old. $\Rightarrow 63 - 9 = 54, 54 \div 2 = 27, 27 + 11 = 38$

Q35. 56. $7 \times 8 = 56$

Q36. 200 men. \Rightarrow Adults $\Rightarrow 814 - 278 = 536, 2U \Rightarrow 536 - 136 = 400, 1U \Rightarrow 400 \div 2 = 200.$

Q37. \$200. $\rightarrow 4U \rightarrow 160, 1U \rightarrow 160 \div 4 = 40, 50 - 40 \times 5 = 200$

Q38. \$224 $\rightarrow 5U \rightarrow 550 - 20 = 530 - 20 = 510,$
 $1U \rightarrow 510 \div 5 = 102, WATCH \rightarrow 102 + 20 = 122,$
TOTAL $\rightarrow 122 + 102 = 224$

Q39. 19 sweets $\rightarrow 8 \times 15 = 120, 291 - 120 = 171, 171 \div 9 = 19$

Q40. \$90. $\rightarrow 5U \rightarrow 350, 1U \rightarrow 350 \div 5 = 70, 20 \rightarrow 70 \times 2 = 140, BAGS \rightarrow 140 - 50 = 90$

Q41. 200 more. $\rightarrow 12U \rightarrow 1200, 1U \rightarrow 1200 \div 12 = 100, Chicken \rightarrow 100 \times 5 = 500, geese \rightarrow$
 $100 \times 3 = 300, Difference \rightarrow 500 - 300 = 200.$

Q42a. 135 stickers. $\rightarrow 215 + 55 = 270, 2U \rightarrow 270, 1U \rightarrow 270 \div 2 = 135.$

Q42b. 540 stickers $\rightarrow TOM \rightarrow 135 \times 3 = 405, TOTAL \rightarrow 405 + 135 = 540$

Q43. 100 $\rightarrow 5P + 5HP = 20 \times 5 = 100.$

THE END