



RED SWASTIKA SCHOOL

SCIENCE 2018 SEMESTRAL EXAMINATION 2 PRIMARY 3

Name : _____ ()

Class : Primary 3/ _____

Date : 26 October 2018

BOOKLET A

Total time for Booklets A & B: 1h 30 min

Booklet A: 18 questions (36 marks)

Note:

1. Do not open the booklet until you are told to do so.
2. Read carefully the instructions given at the beginning of each part of the booklet.
3. Do not waste time. If the question is too difficult for you, go on to the next question.
4. Check your answers thoroughly and make sure you attempt every question.
5. In this booklet, you should have the following:
 - a. Page 1 to Page 13
 - b. Questions 1 to 18

For Questions 1 to 18, choose the most suitable answer and shade its number in the OAS provided.

1. The flow chart shows how things are classified.

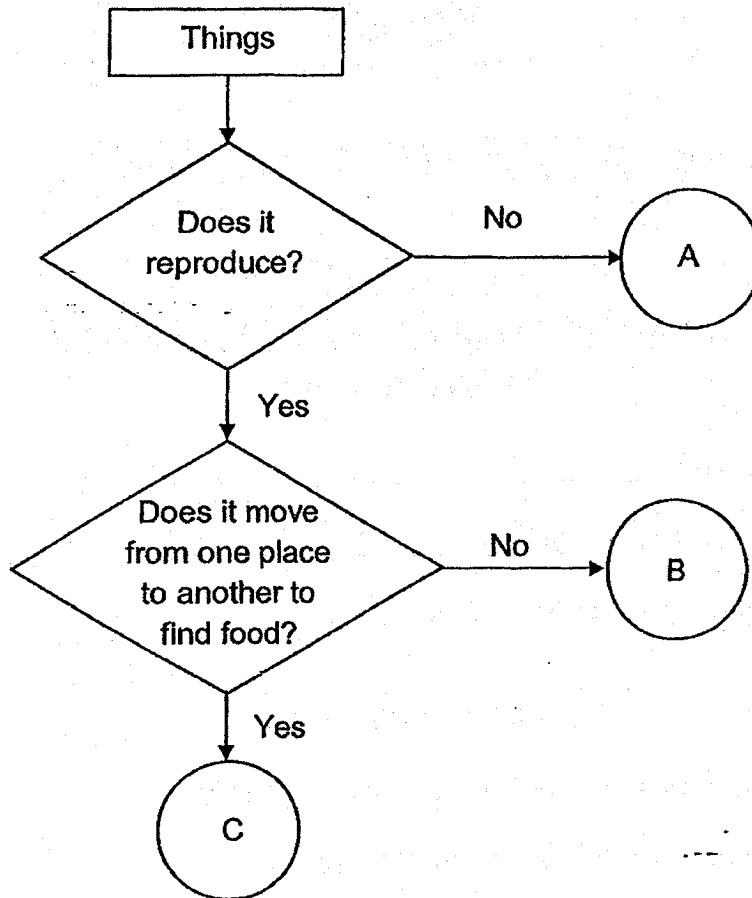

Based on the information above, which of the following best represents a plant, a coin and a monkey?

	Plant	Coin	Monkey
(1)	A	B	C
(2)	B	A	C
(3)	B	C	A
(4)	C	B	A

2. The animals below are grouped according to one common characteristic.

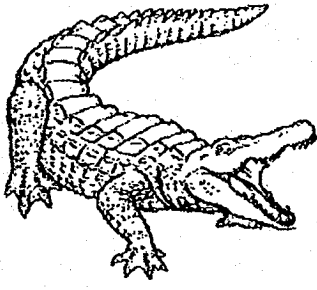
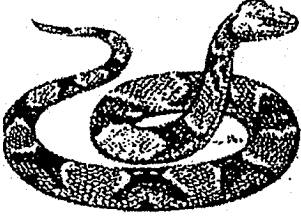
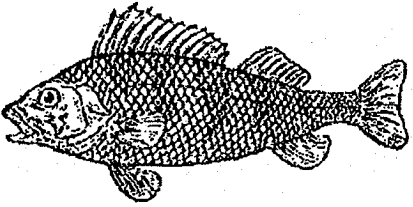
	
Animal W	Animal X
	
Animal Y	Animal Z

Based on your observations, which one of the following animals does not belong to the group based on their outer body covering?

- (1) W
- (2) X
- (3) Y
- (4) Z

3. The classification chart shows how some organisms are classified.

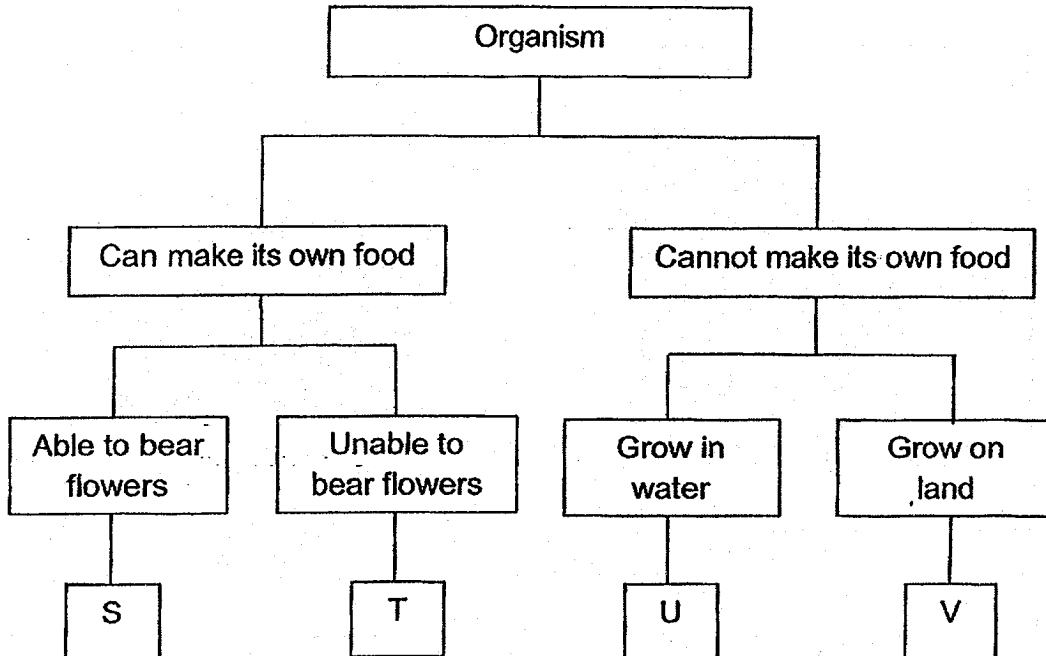

Which one of the following correctly represents bread mould and fern?

	Bread mould	Fern
(1)	S	V
(2)	T	V
(3)	V	S
(4)	V	T

4. Which of the following human systems is incorrectly matched to its function?

	System	Function
(1)	Circulatory	Transports waste materials away from the different parts of the body.
(2)	Digestive	Transports digested food to all parts of the body.
(3)	Respiratory	Helps the body to take in and remove air.
(4)	Skeletal	Supports our body and gives it a shape.

5. The diagram below shows a plant.

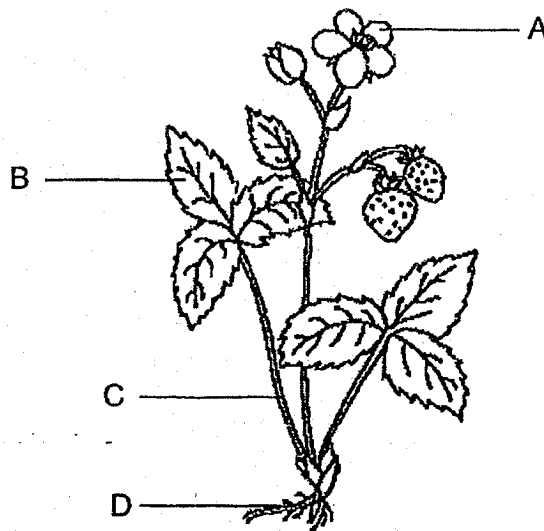

Which one of the following about the plant parts is correct?

	Absorbs water	Makes food
(1)	C	A
(2)	C	B
(3)	D	A
(4)	D	B

6. Which of the following statements describe the function(s) of the stem?

- X: Supports the plant.
- Y: Holds the plant firmly to the soil.
- Z: Transports water and mineral salts.

- (1) X only
- (2) X and Z only
- (3) Y and Z only
- (4) X, Y and Z

7. Study the human body system below.

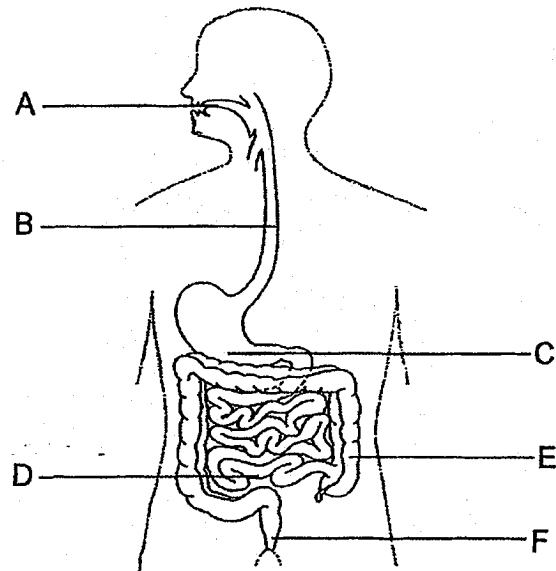

Which of the following is correct?

	Parts where digestive juice is added	Part where solid waste is passed out of the body
(1)	A, B and C	E
(2)	B, C and D	E
(3)	A, B and D	F
(4)	A, C and D	F

8. Study the information below carefully.

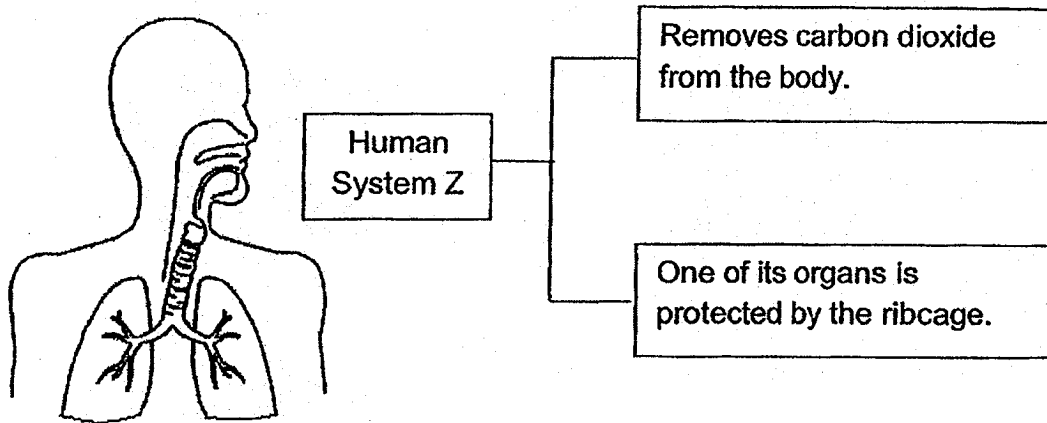

Which one of the following is also a function of human system Z?

- (1) It gives the body a shape.
- (2) It takes in oxygen into the body.
- (3) It removes undigested food from the body.
- (4) It transports water to all parts of the body.

9. Plants P and Q are shown below. It was observed that plant P died after some time but plant Q continued to grow.

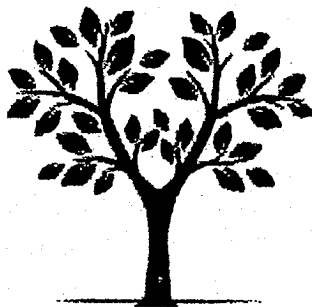

Plant P

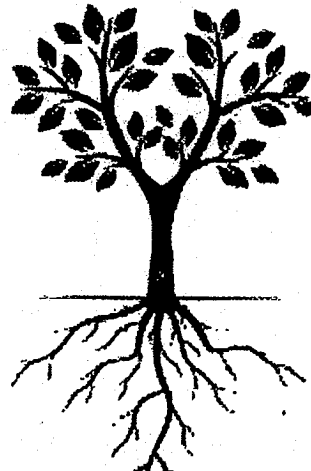

Plant Q

What could be the reason why plant P died after some time?

- (1) It does not have flowers to make food.
 - (2) It does not have flowers to reach for sunlight.
 - (3) It does not have roots to absorb water from the soil.
 - (4) It does not have roots to absorb food from the soil.
10. John was given two rulers made of different materials. He wanted to compare which ruler was more flexible. Which of the following should he do?
- (1) Bend both rulers.
 - (2) Put both rulers into water.
 - (3) Shine a torchlight at both rulers.
 - (4) Weigh both rulers with a weighing scale.

11. Devi wanted to find out the amount of light that can pass through four identical sheets made of different materials, P, Q, R and S. She shone light through the materials and recorded the results in the table below.

Material	Amount of light that passed through (units)
P	5
Q	8
R	2
S	0

Based on the results from the table, Devi made the following statements.

- A: Material S allows no light to pass through.
- B: Material Q allows the least amount of light to pass through.
- C: Material Q allows more light to pass through than Material R.
- D: Material R allows more light to pass through than Material S.

Based on the information given, which of the statements are true?

- (1) A and B only
- (2) C and D only
- (3) A, B and C only
- (4) A, C and D only

12. The table below shows the properties of four materials, A, B, C and D. A tick (✓) indicates that the material has that property.

Properties	Materials			
	A	B	C	D
Strong	✓	✓	✓	
Waterproof		✓	✓	✓
Ability to float in water	✓			✓
Allows light to pass through	✓	✓		

Based on the table above, which of the materials is most suitable for making part X of an umbrella for use on both sunny and rainy days?

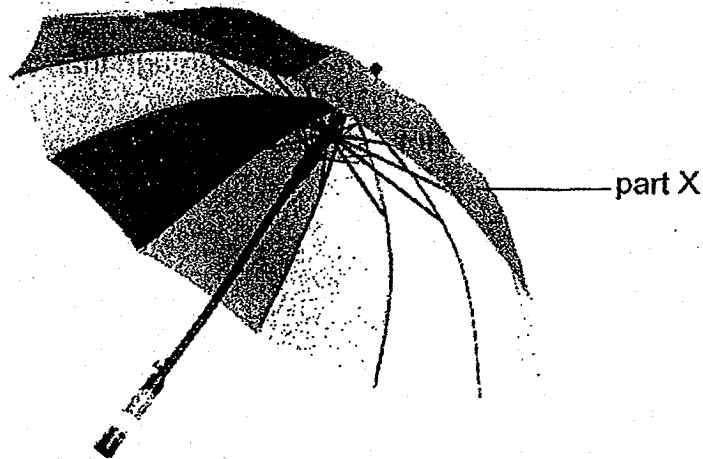

- (1) Material A
- (2) Material B
- (3) Material C
- (4) Material D

13. Four students, Amy, Bala, Caixia and Danish, made the following statements about magnets during their lessons.

Amy : Like poles repel, unlike poles attract.

Bala : Like poles attract, unlike poles repel.

Caixia : The magnetic strength of a magnet is greatest at its poles.

Danish : A magnet always comes to rest in the East-West direction when freely suspended.

Which of the student(s) is/are correct?

- (1) Amy only
- (2) Bala only
- (3) Amy and Caixia only
- (4) Amy, Caixia and Danish only

14. Raju used a bar magnet to stroke a steel nail in the same direction repeatedly as shown below. As a result, the steel nail became a temporary magnet.

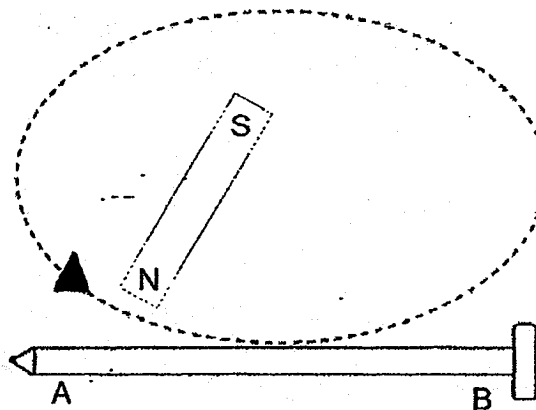

Identify pole A and B of the temporary magnet.

	Pole A	Pole B
(1)	south	south
(2)	south	north
(3)	north	north
(4)	north	south

15. Trina stacked four rings as shown below. Two of the rings are magnets while the other two are made of magnetic materials.

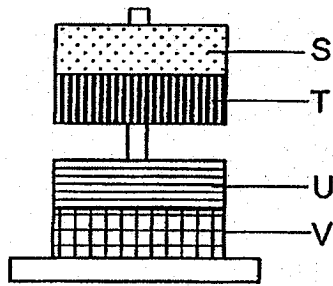

Which of the two rings, S, T, U and V, are magnets?

- (1) S and T
- (2) U and V
- (3) S and V
- (4) T and U

16. A compass has a small magnet that can rotate freely as shown.

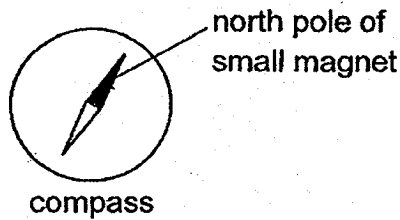

Two bar magnets were arranged such that they were repelling each other. A compass was then placed near pole X of one of the bar magnets. The direction of the compass needle is as shown below.

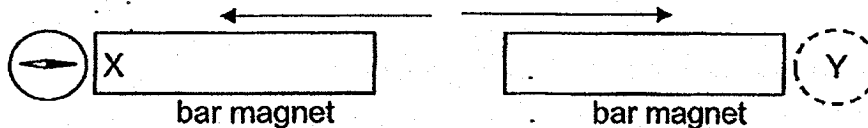

What would be the direction of the needle when the compass was placed at position Y?

- (1)
- (2)
- (3)
- (4)

17. Three bar magnets, AB, CD and EF, are arranged as shown below.

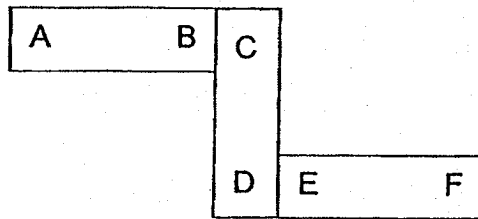

When the bar magnets are rearranged, which one of the following arrangements of the magnets is not possible?

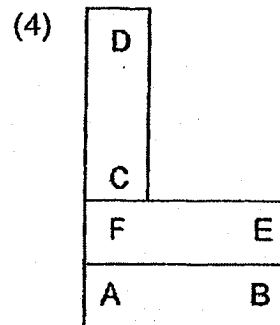
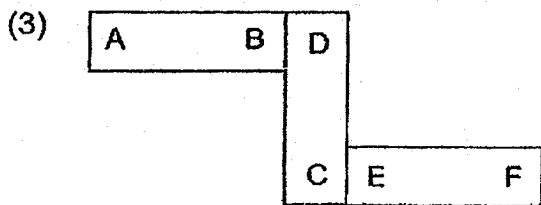
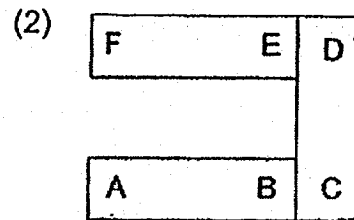
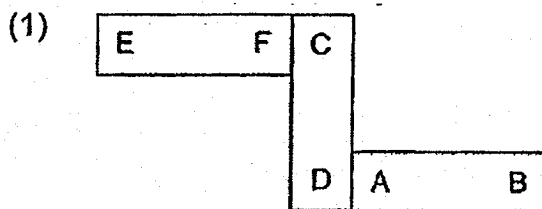

18. Ken tried to magnetise three identical rods A, B and C, using the electrical method. He used a different number of batteries in the set-up for each rod. He used the three rods to attract iron pins and recorded his results in the table as shown below.

Number of coils of wire around the rod	Number of iron pins attracted		
	Rod A	Rod B	Rod C
10	2	9	6
20	3	12	8
40	4	14	11

Which of the following statements is correct?

- (1) The set-up for rod A has the most number of batteries.
- (2) The set-up for rod B has the most number of batteries.
- (3) The set-up for rod B has less batteries than the set-up for rod C.
- (4) The set-up for rod A has more batteries than the set-up for rod C.

END OF BOOKLET A



RED SWASTIKA SCHOOL

SCIENCE 2018 SEMESTRAL EXAMINATION 2 PRIMARY 3

Name : _____ ()

Class : Primary 3/ _____

Date : 26 October 2018

BOOKLET B

8 Questions
24 Marks

In this booklet, you should have the following:

- Page 14 to Page 23
- Questions 19 to 26

MARKS

	OBTAINED	POSSIBLE
BOOKLET A		36
BOOKLET B		24
TOTAL		60

Parent's Signature : _____

Answer all questions in the space provided.

19. Ali observed three living things, A, B and C, in the school garden and recorded their characteristics in the table below. A tick (✓) indicates that the living thing has that characteristic.

Characteristics	Living things		
	A	B	C
Reproduces by spores		✓	
Needs air to survive	✓	✓	✓
Needs sunlight to make food	✓		

- (a) Complete the table below by matching the living thing to the correct letter, A, B or C. (2m)

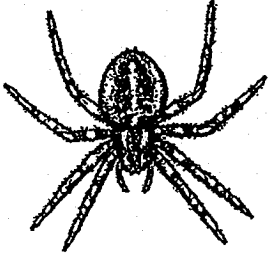
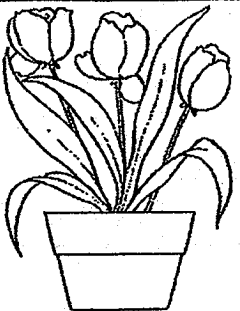
Living things	Letter
	
	

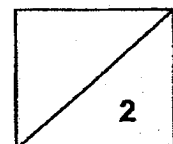

19. Melody placed two similar oranges in two identical containers, X and Y. She placed the containers in the same room.

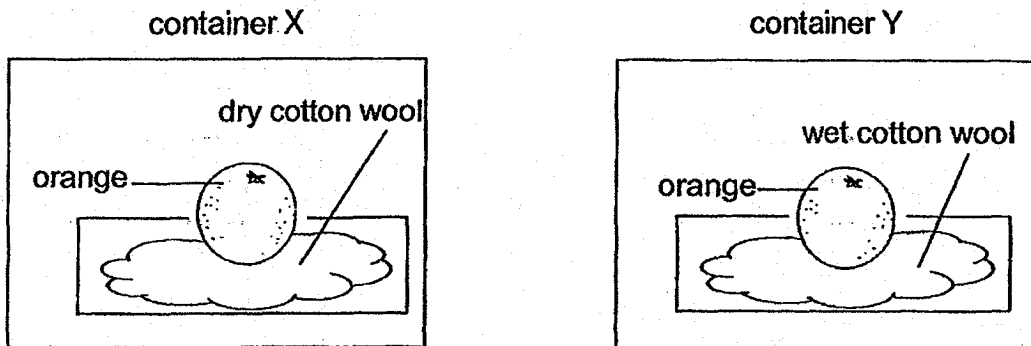

- (b) In which container, X or Y, would mould first grow on the orange? (1m)

- (c) Explain your answer for part (b). (1m)

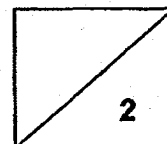

20. Siti set up the following experiment to find out if the number of roots affect the amount of water absorbed by a plant. She recorded the amount of water left in the beaker over five days in a table shown below.

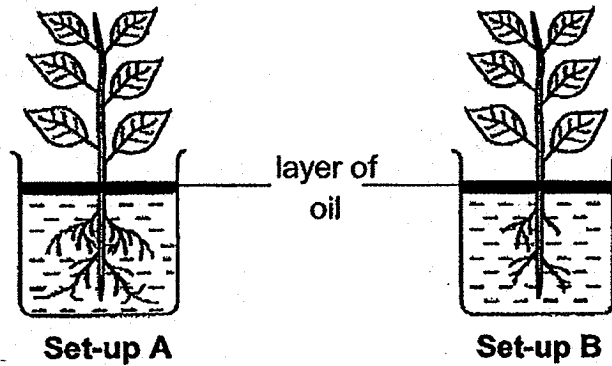

	Amount of water left in the beaker (ml)		
	Day 1	Day 3	Day 5
Set-up A	400	330	240
Set-up B	400	380	365

- (a) Compare the amount of water left in set-up A and B on day 5. (1m)

- (b) What can Siti conclude from the experiment on day 5? (1m)

- (c) Based on the experiment, tick the variable(s) that must be kept the same to conduct a fair test. (1m)

Variable	Tick the variable to be kept the same (✓)
Location to place set-up A and B.	
Water left in the beaker at the end of the experiment.	
Type of plant used.	

21. (a) Read the statements about the human digestive system carefully. Write 'T' for true or 'F' for false for each statement. (2m)

Statements	T / F
Digestion starts in the stomach.	
Digestion does not take place in the large intestine.	
Saliva makes the food soft so that it is easy to swallow.	
Digested food is passed through the walls of the large intestine into the blood and is carried to all parts of the body.	

- (b) Ahmad classified the parts of the human digestive system as shown below.

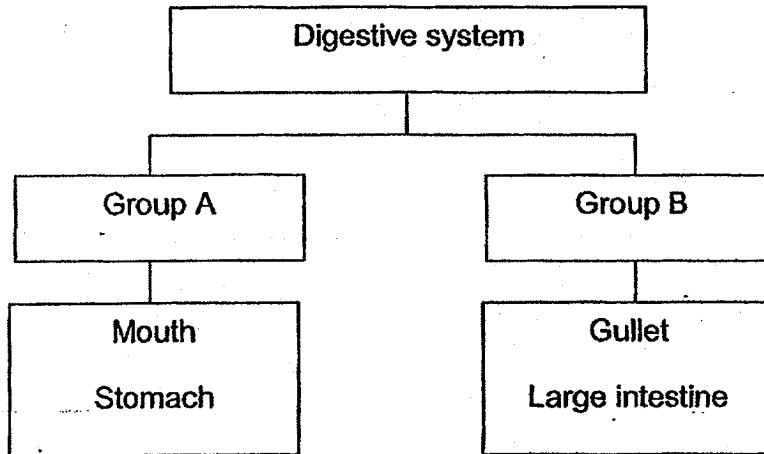

Provide a suitable heading for group A and B. (1m)

Group A: _____

Group B: _____

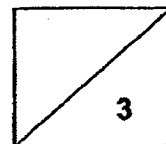

22. Select only the correct parts from the list below and match them to the correct human system. (2m)

heart	lungs	skull
windpipe	rib cage	blood vessels

<p><u>Circulatory System</u></p>	<p><u>Respiratory System</u></p>
---	---

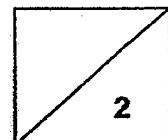

23. Xiao Ming made three similar bags, A, B and C, using different materials. The table below shows some of the properties of the bags. A tick (✓) indicates that the bag has that property.

Properties of the material of the bag	Bags		
	A	B	C
It is strong.	✓		✓
It is flexible.	✓	✓	✓
It is waterproof.			✓
It sinks in water.	✓	✓	

- (a)(i) Xiao Ming needs to carry heavy books to school. Based on the table, which bag, A, B or C, is the least suitable? Explain the answer. (1m)

- (a)(ii) Based on the table, how is the material for bag A similar to the material for bag C? (1m)

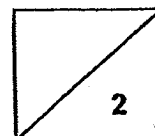

23. Mary conducted an experiment to find out which material, W, X, Y or Z, is most suitable to be made into a bath towel. The materials used in the experiment were of the same shape, size and thickness.

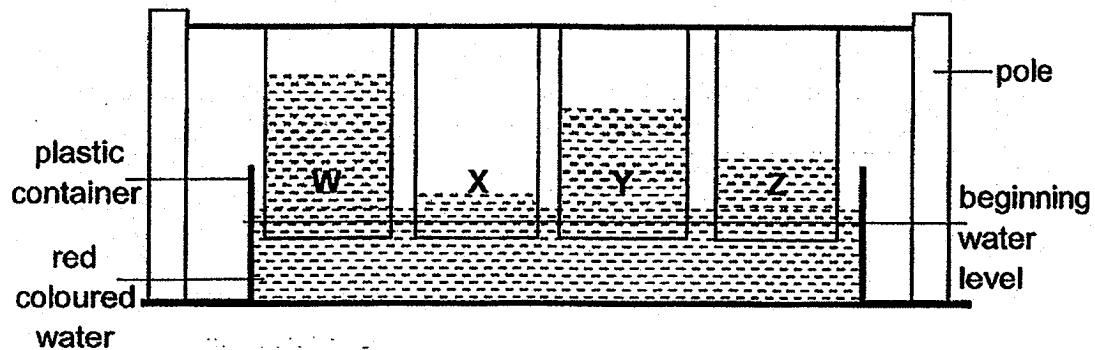

After ten minutes, the red-coloured water had travelled up each material as shown in the diagram.

- (b)(i) Which material, W, X, Y or Z, is most suitable for Mary to make into a bath towel? (1m)

- (b)(ii) Explain your answer for part (b)(i). (1m)

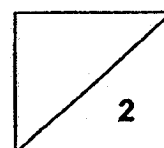

24. Danny had four magnets, A, B, C and D, of the same size and shape. He placed a paper clip at point X. He kept moving each magnet towards the paper clip until the paper clip was attracted to the magnet. He measured the distance (d) at which the magnet was able to attract the paper clip.

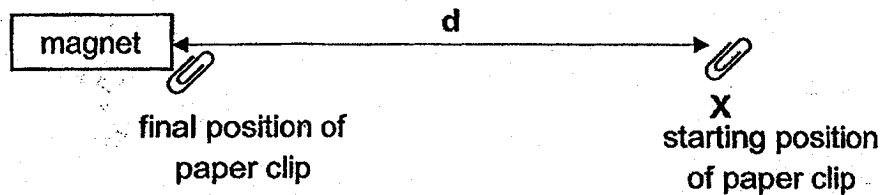

He recorded his results in the table shown below.

Magnet	Distance (d) in cm
A	8
B	2
C	12
D	4

- (a) Based on the information given, arrange the magnets in order of their magnetic strength, from the least to the most magnetic strength. (1m)
-

- (b) Give an example of a material that can be used to make the paper clip for the experiment to work. (1m)
-

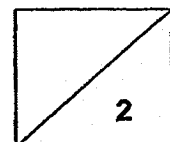

25. An experiment was conducted using the set-up shown to find out which magnet has the greatest magnetic strength. The experiment was repeated with magnets B and C.

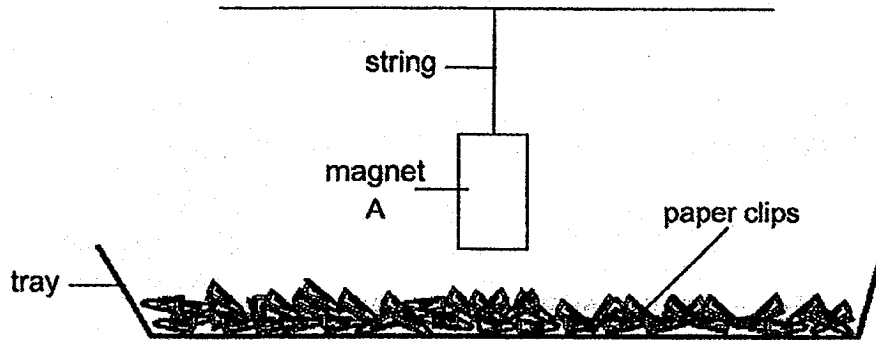

The results of the experiment are shown below.

Number of paper clips attracted

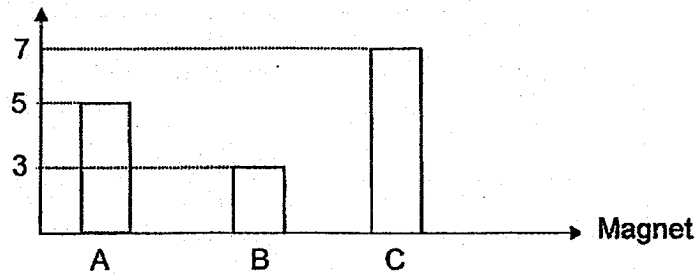

- (a) What can be concluded about the magnetic strength of magnet C from this experiment? (1m)
-
- (b) Will the experiment work if the paper clips were replaced with copper pins? Explain. (1m)
-
- (c) Based on the diagram, how can the length of the string be changed so that magnet A can attract more paper clips? (Do not cut the string) (1m)
-

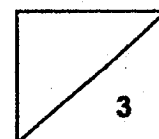

26. Ramli set up the experiment as shown below.

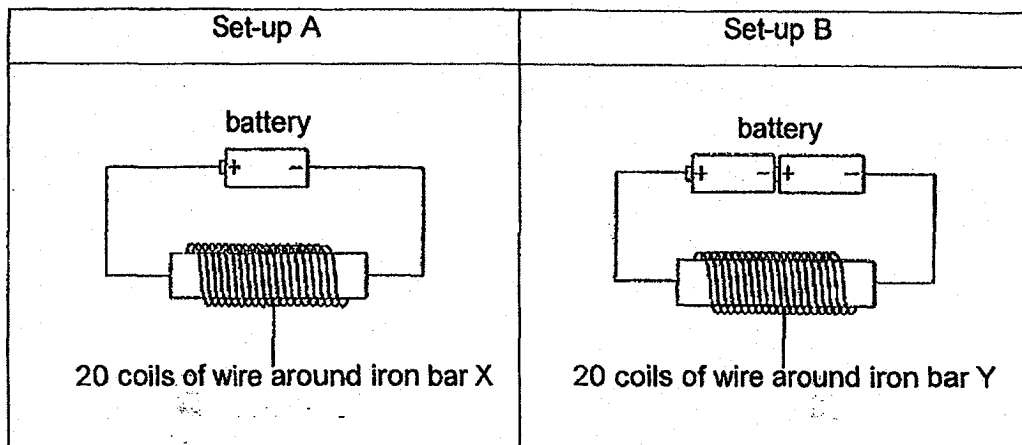

He lowered the iron bars, X and Y, into a tray of steel pins and counted the number of steel pins attracted by each bar. The table below shows the results.

Iron bar	Number of steel pins attracted
X	4
Y	9

(a) Based on the information given, state the relationship between the number of batteries used and the magnetic strength of the electromagnet. (1m)

(b) Without changing the number of batteries, what can be done to the parts in set-up A to enable iron bar X to pick up more steel pins? (1m)

(c) What will happen to both iron bars X and Y when the batteries are removed in set-ups A and B? (1m)

**END OF BOOKLET B
PLEASE CHECK YOUR WORK**

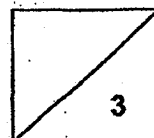

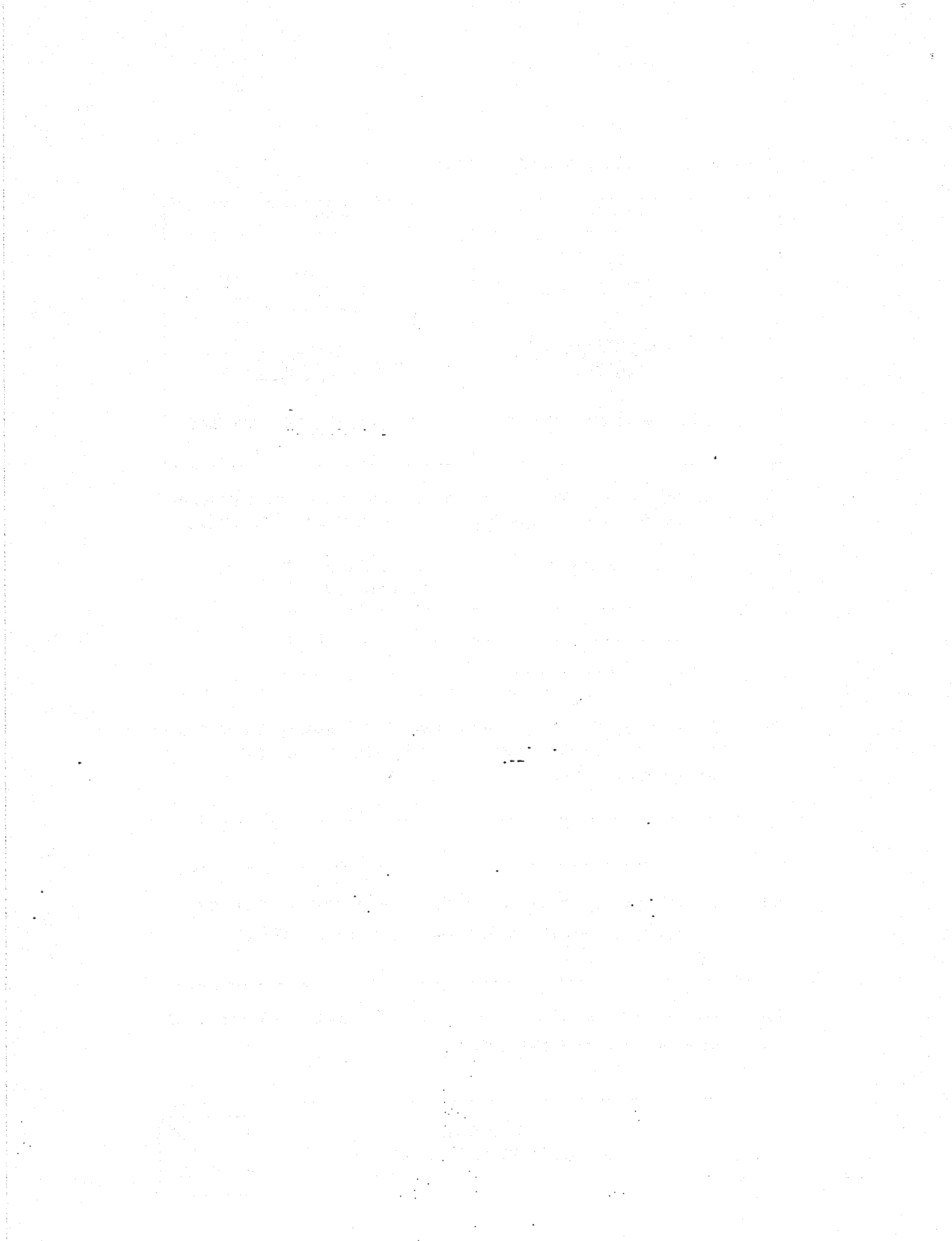

EXAM PAPER 2018 (P4)

SCHOOL : RED SWASTIKA

SUBJECT : SCIENCE

TERM : SA2

Q1	Q2	Q3	Q4	Q5	Q6	Q7	Q8	Q9	Q10
2	1	4	2	4	2	4	2	3	1
Q11	Q12	Q13	Q14	Q15	Q16	Q17	Q18		
4	3	3	4	4	2	3	2		

Q19) a) C

A

b) Y

c) Y has warmth and moisture and mould need warmth and moisture to grow.

Q20) a) Set-up B have more water left than set-up A.

b) More roots absorb more water.

c) Location to place set-up A and B , Type of plant used

Q21) a) Digestion starts in the stomach – F

Digestion does not take place in the large intestine – T

Saliva makes the food soft so that it is easy to swallow – T

Digested food is passed through the walls of the large intestine into the blood and is carried to all parts of the body – F

b) Group A : digestion take place

Group B : digestion do not take place

Q22) Circulatory system – heart , blood vessels

Respiratory system – windpipe , lungs

Q23) a) i) B, it is not strong.

ii) They both are flexible and strong.

b) i) W

ii) It is not waterproof

Q24) a) B , D , A , C

b) Steel

Q25) a) It is the strongest

b) No, copper is not magnetic.

c) Increase the length of the string.

Q26) a) More battery make the electromagnet stronger.

b) coil more rounds of wire

c) The electromagnet will not be a magnet anymore.