



CATHOLIC HIGH SCHOOL
SEMESTRAL ASSESSMENT TWO (2018)
PRIMARY THREE
MATHEMATICS

Name : _____ ()

Class : Primary 3 _____

Date : 29 October 2018

Duration : 1 h 45 min

Parent's Signature: _____

Section A	30
Section B	34
Section C	16
Total Marks	80

INSTRUCTIONS TO CANDIDATES

Do not turn over this page until you are told to do so.

Follow all instructions carefully.

Answer all questions.

For section A, shade your answers in the Optical Answer Sheet (OAS) provided.

This booklet consists of 19 printed pages excluding the cover page.

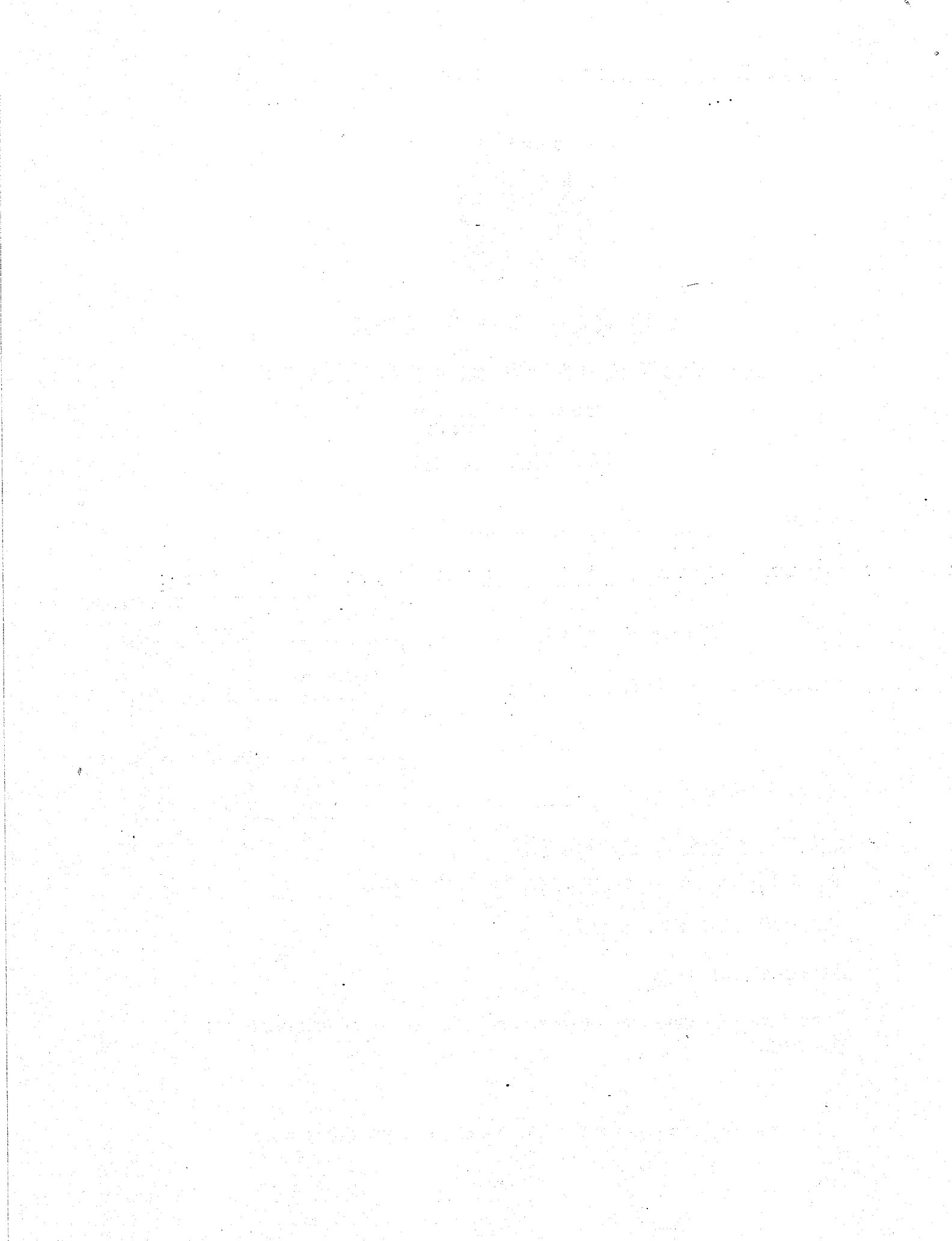

Section A

Questions 1 to 15 carry 2 marks each. For each question, four options are given. One of them is the correct answer. Make your choice (1, 2, 3 or 4). Shade the correct oval (1, 2, 3 or 4) on the Optical Answer Sheet (OAS). All diagrams are not drawn to scale. (30 marks)

1. What is three thousand, four hundred and forty in numerals?

(1) 3040

(2) 3400

(3) 3440

(4) 3444

()

2. What is the value of digit 6 in 7362?

(1) 6

(2) 60

(3) 600

(4) 6000

()

3. Which of the following numbers is the smallest even number?

(1) 2391

(2) 2392

(3) 2929

(4) 2930

()

4. What is the remainder when 839 is divided by 5?

(1) 1

(2) 2

(3) 3

(4) 4

()

5. What is the sum of 1899 and 2760?

(1) 861

(2) 1139

(3) 4559

(4) 4659

()

6. 5 groups of 9 = _____.

(1) $5 + 9$

(2) $9 \div 5$

(3) $9 \times 9 \times 9 \times 9 \times 9$

(4) $9 + 9 + 9 + 9 + 9$

()

7. Find the product of 312 and 6.

(1) 1872

(2) 318

(3) 306

(4) 52

()

8. In the figure below, name a pair of parallel lines in the square grid.

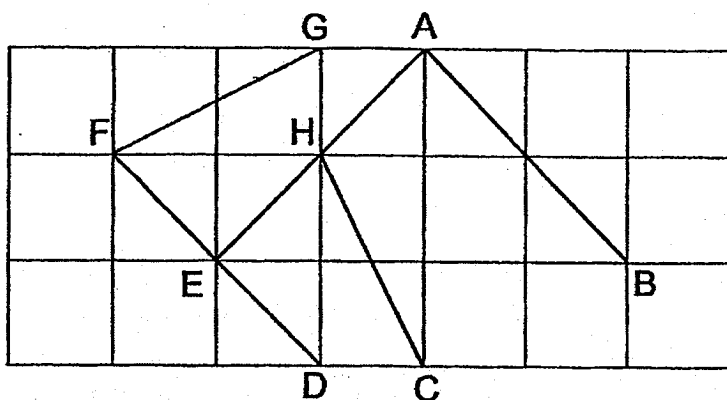

- (1) DF and BA
 (2) DF and AE
 (3) GF and AE
 (4) CH and BA

()

9. $\frac{3}{8} - \boxed{?} = \frac{1}{4}$

What is the missing fraction in the box?

- (1) $\frac{1}{2}$
 (2) $\frac{1}{3}$
 (3) $\frac{1}{8}$
 (4) $\frac{5}{8}$

()

10. There were 9000 spectators watching a football match. 856 of them were female spectators. How many male spectators were there?

- (1) 8144
(2) 8154
(3) 8244
(4) 9856

()

11. In the figure below, which of these angles is an acute angle?

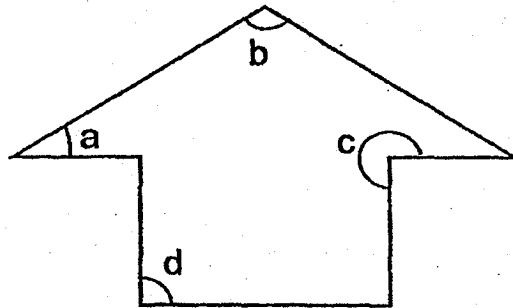

- (1) $\angle a$
(2) $\angle b$
(3) $\angle c$
(4) $\angle d$

()

12. A bookshop sold a highlighter and a pen for \$3. Claire bought 6 highlighters and 6 pens. How much did Claire pay altogether?

- (1) \$12
(2) \$15
(3) \$18
(4) \$36

()

13. Figure ABCD is made up of identical rectangles. What fraction of ABCD is not shaded?

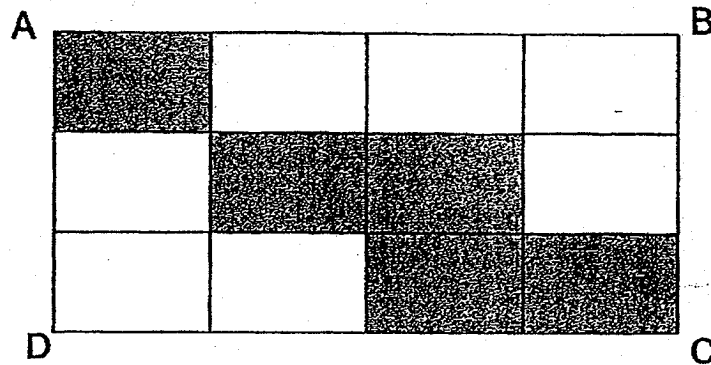

- (1) $\frac{5}{7}$
(2) $\frac{7}{12}$
(3) $\frac{1}{2}$
(4) $\frac{5}{12}$

()

-
14. How many minutes are there in 3 h 15 min?

- (1) 15 minutes
(2) 180 minutes
(3) 195 minutes
(4) 315 minutes

()

15. A glass of orange juice costs \$2.50 and a glass of lemon juice costs \$1.80. Claire bought 2 glasses of orange juice and a glass of lemon juice. How much did she pay?

(1) \$4.30

(2) \$5.00

(3) \$6.10

(4) \$6.80

()

END OF SECTION A

Section B

Do not write
in this space

Questions 16 to 21 carry 1 mark each. Show your working clearly in the space and write the correct answers in the spaces provided. For questions which require units, give your answers in the units stated. All diagrams are not drawn to scale. (6 marks)

16. Express $\frac{6}{9}$ in its simplest form.

Ans: _____

17. Complete the following number pattern.

1750, 1850, 1950, _____?, 2150, 2250

Ans: _____

18. 7 m 4 cm = _____?_____ cm

Ans: _____ cm

19. Find the difference between 2270 and 1654.

Do not write
in this space

Ans: _____

20. Find the area of the square shown below.

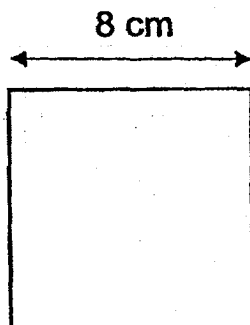

Ans: _____ cm²

21. What is the missing number in the box?

$$\frac{3}{4} = \frac{\boxed{?}}{12}$$

Ans: _____

Total marks for questions 16 to 21

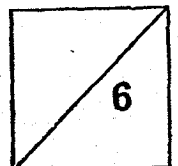

Questions 22 to 35 carry 2 marks each. Show your working clearly and write your answers in the spaces provided. For questions which require units, give your answers in the units stated. All diagrams are not drawn to scale. (28 marks)

Do not write
in this space

22. Arrange the following fractions in order.
Begin with the greatest.

$$\frac{7}{10}, \frac{2}{5}, \frac{1}{2}$$

Ans: _____, _____, _____
greatest smallest

23. What is the quotient when 918 is divided by 7?

Ans: _____

24. The difference between two numbers is 785. The bigger number is 1072. What is the other number?

Ans: _____

25. In the sum below, a digit is missing from the box. What is the missing digit?

$$\begin{array}{r} 23\boxed{?}7 \\ + 3185 \\ \hline 5562 \end{array}$$

Ans: _____

Do not write
in this space

26. Derrick and Evan shared some stickers equally. After Derrick gave Evan 47 stickers, how many more stickers does Evan have than Derrick?

Ans: _____

The bar graph below shows the number of trading cards that 4 boys have. Study the graph carefully and answer questions 27 and 28.

Do not write
in this space

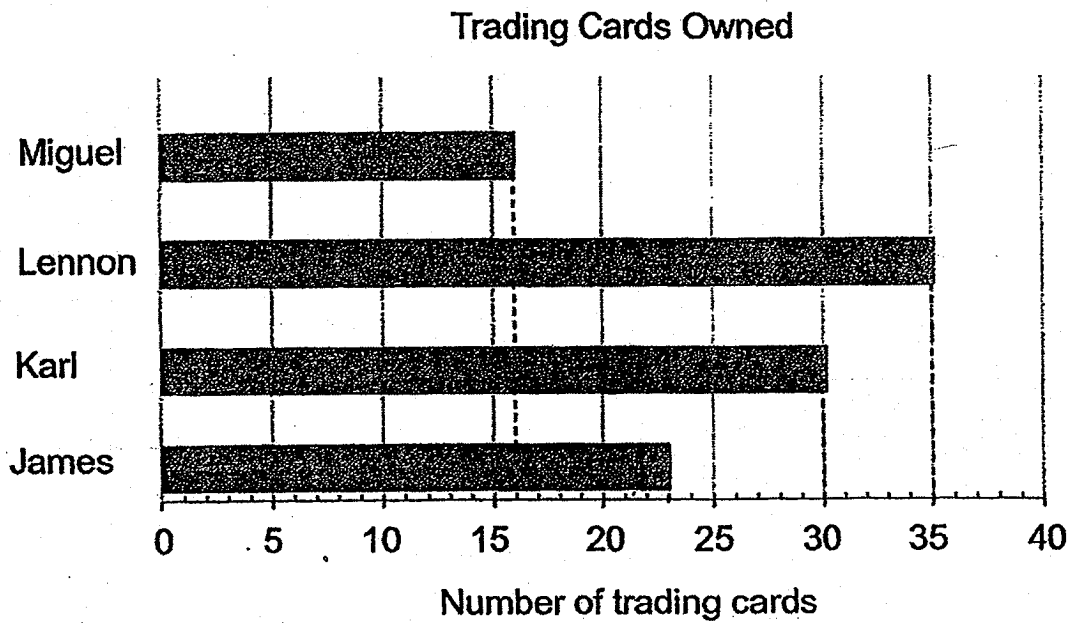

27. How many fewer trading cards does Miguel have compared than Lennon?

Ans: _____

28. How many trading cards do the 4 boys have altogether?

Ans: _____

29. When a number is divided by 4, it has a remainder of 2.
The number is between 20 and 25. What is the number?

Do not write
in this space

Ans: _____

30. 100 g of cherries cost \$2.
What is the cost of 1 kg of cherries?

Ans:\$ _____

31. Find the mass of the bag of sugar.

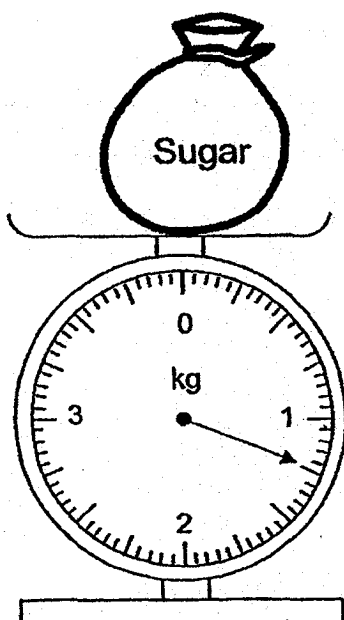

Ans: _____ kg _____ g

32. A shopkeeper had 297 story books. He wanted to pack them equally into 8 boxes. How many story books were left unpacked?

Do not write
in this space

Ans: _____



33. Figure EFGH below is made up of 3 identical rectangles. Find the perimeter of figure EFGH.

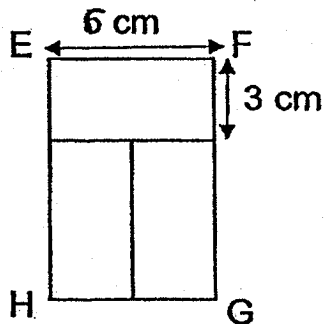

Ans: _____ cm



34. Laurence took 1h 55 min to finish his homework. He ended at 2.15 p.m. What time did he start doing his homework?

Do not write
in this space

Ans: _____ p.m.

35. Jacob bought 9 packets of potato chips. He planned to eat a packet every 3 days. How many days would he take to finish eating all the packets of potato chips?

Ans: _____

Total marks for questions 22 to 35

END OF SECTION B

Section C

Do not write
in this space

For Questions 36 to 40, show your working clearly and write your answers in the spaces provided. The number of marks available is shown in brackets [] at the end of each question or part-question. All diagrams are not drawn to scale. (16 marks)

36. Rita collected some beads. She gave 45 of them away and packed the remaining beads into 5 bags. There were 67 beads in each bag. How many beads did Rita collect?

Ans: _____ [3]

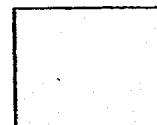

37. The capacity of a beaker is 240 ml.
2 such beakers of water can fill a jug completely.
6 such jugs of water can fill a tank completely.
What is the capacity of the tank?
Write your answer in litres and millilitres.

Do not write
in this space

Ans: _____ [3]

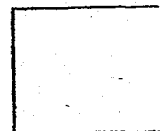

38. Mary, Laura and Joyce baked some cookies.
Mary baked twice as many cookies as Joyce.
Laura baked thrice as many cookies as Mary.
Laura baked 405 more cookies than Joyce.
How many cookies did Mary bake?

Do not write
in this space

Ans: _____ [3]



39. Alan had \$50. He bought a pair of shorts and a blouse. A blouse cost \$12 more than a pair of shorts. He received \$2 change. How much did a pair of shorts cost?

Do not write
in this space

Ans: _____ [3]

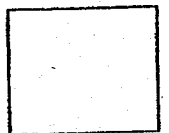

40. Rectangles and dots are arranged to form the figures below. Study the pattern of the figures as shown below.

Do not write in this space

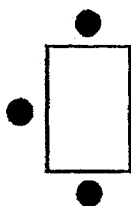

Pattern 1

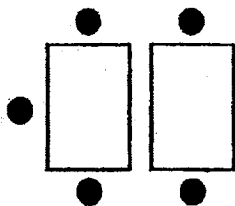

Pattern 2

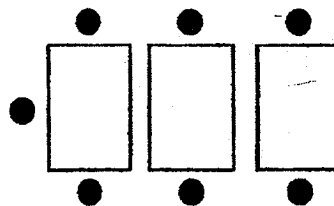

Pattern 3

Pattern Number	Number of rectangles	Number of dots
1	1	3
2	2	5
3	3	7
4	a)	b)

[2]

- a) Fill in the missing number of rectangles for Pattern 4.
- b) Fill in the missing number of dots for Pattern 4.
- c) How many dots are needed for Pattern 10?

Ans: c) _____ [2]

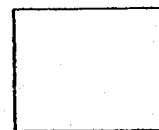

END OF PAPER

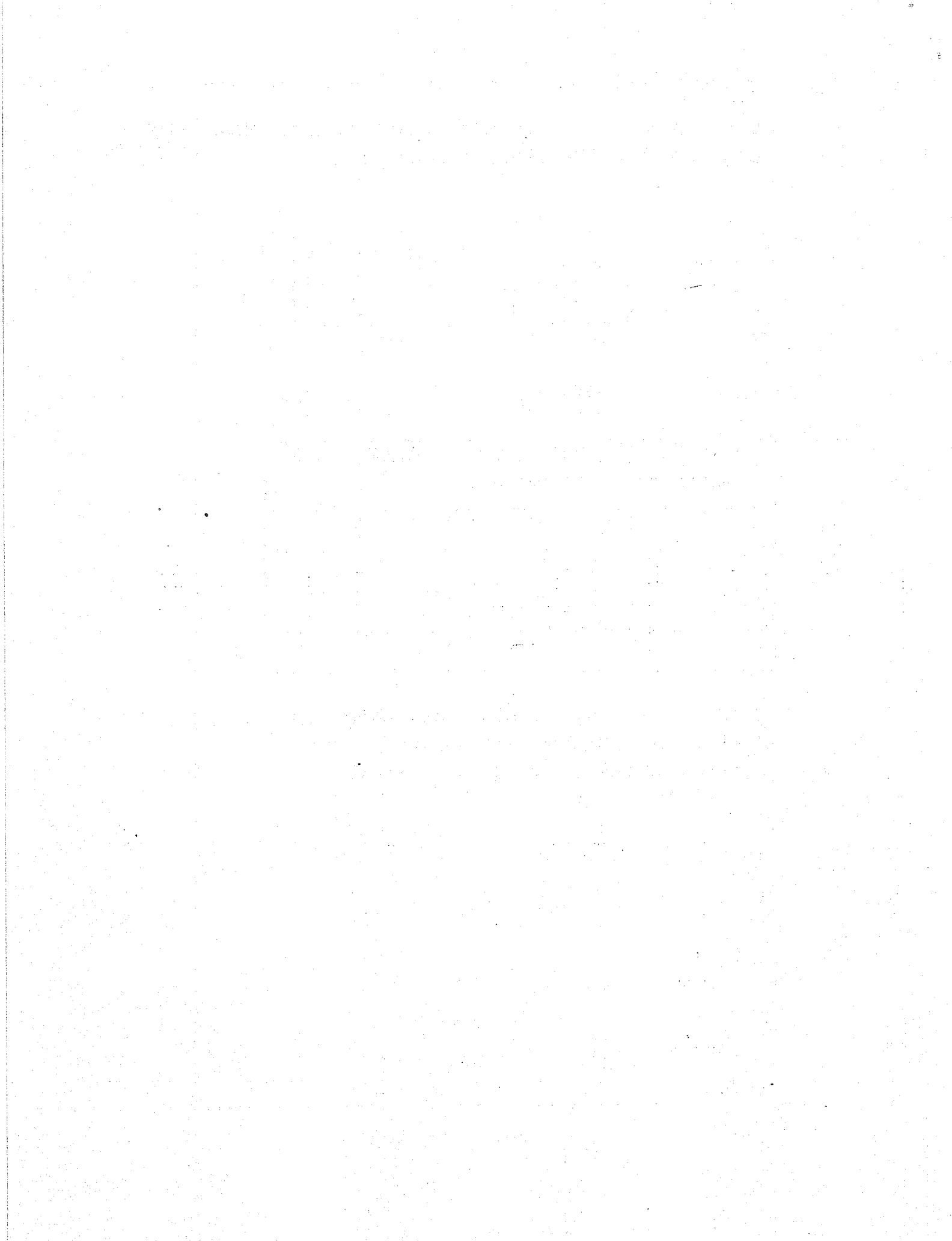

SCHOOL : CATHOLIC HIGH PRIMARY SCHOOL

LEVEL : PRIMARY 3

SUBJECT : MATH

TERM : 2018 SA2

BOOKLET A

Q 1	Q2	Q3	Q4	Q5	Q6	Q7	Q8	Q9	Q10
3	2	2	4	4	4	1	1	3	1
Q 11	Q12	Q13	Q14	Q15					
1	3	2	3	4					

BOOKLET B

Q16)	$2/3$
Q17)	$1950 + 100 = 2050$
Q18)	$7m = 700cm$ $700cm + 4cm = 704 cm$
Q19)	$2270 - 1654 = 616$
Q20)	$8cm \times 8cm = 64cm^2$
Q21)	$3 \times 3 = 9$
Q22)	$7/10, 1/2, 2/5$
Q23)	$918 \div 7 = 131 R1$
Q24)	$1072 - 785 = 287$ $287 + 785 = 1072$
Q25)	7
Q26)	$47 \times 2 = 94$
Q27)	$35 - 16 = 19$
Q28)	$16 + 35 + 30 + 23$ $= 51 + 53 = 104$
Q29)	22
Q30)	$\$2 \times 10 = \20

Q31)	1kg 250g
Q32)	$297 \div 8 = 37 \text{ R}1$ Ans: 1
Q33)	$6 + 9 + 6 + 9 = 30\text{cm}$
Q34)	12.20 p.m.
Q35)	$9 \times 3 = 27$
Q36)	$67 \times 5 = 335$ $335 + 45 = 380$
Q37)	$240 \times 2 = 480$ $480 \times 6 = 2880$ $2880\text{ml} = 2 \text{ L } 880\text{ml}$
Q38)	$405 \div 5 = 81$ $81 \times 2 = 162$
Q39)	$\$50 - \$2 = \$48$ $\$48 - \$12 = 36$ $\$36 \div 2 = \18
Q40)	a)4 b)9 c) $10 - 3 = 7$ $7 \times 2 = 14$ $14 + 7 = 21$