

HENRY PARK PRIMARY SCHOOL  
2010 SCIENCE COMMON TEST 2  
PRIMARY 3

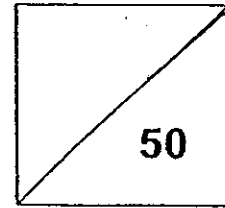

Duration of Paper: 50 min

Name: \_\_\_\_\_

Parent's Signature

Class: Pr 3 \_\_\_\_\_

**PART 1 (30 marks)**

For each question from 1 to 15, four options are given. One of them is the correct answer. Make your choice (1, 2, 3 or 4) and write its number in the bracket provided.

1. Which one of the following objects is made of a material that came from a living thing?

- (1) stone tile
- (2) glass cup
- (3) steel spoon
- (4) wooden chair

( )

2. The purpose of windows is to allow light to enter inside a house in order to conserve electricity. Which one of the following properties of a material is most important when making the windows of the house?

- (1) strength
- (2) flexibility
- (3) hardness
- (4) transparency

( )

3. The table below shows the properties of Material A, B, C and D.

Properties of the Material	Material A	Material B	Material C	Material D
Hard	✓			✓
Strong		✓		
Flexible			✓	✓
Waterproof		✓	✓	

Which material A, B, C or D is most suitable to be made into bricks for building a house?

- (1) A
- (2) B
- (3) C
- (4) D

( )

4. The first little pig built his house using straw but it was very easily destroyed by the wolf.



Which property/properties of straw best explains why the wolf was able to destroy the straw house?

- A: light
- B : can break easily
- C: cannot be scratched easily
- D: can bend

- (1) A only
- (2) B only
- (3) C and D only
- (4) A, B and C only

( )

5. The classification table shows how some materials are classified.

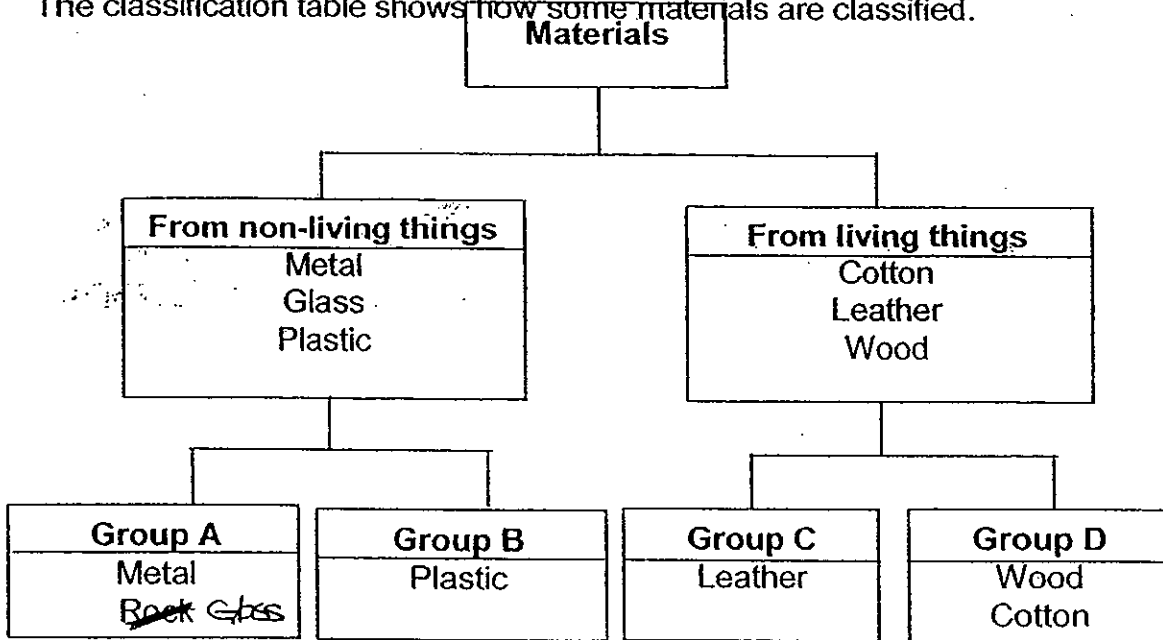

Which one of the headings listed below correctly represents Groups A, B, C and D?

	Group A	Group B	Group C	Group D
(1)	From animals	From plants	From the ground	Man made
(2)	Man made	From the ground	From plants	From animals
(3)	From the ground	Man made	From animals	From plants
(4)	From plants	From the ground	From animals	Man made

( )

6. Jim set up the experiment below to find out whether the objects made of 4 different materials will float or sink in water.

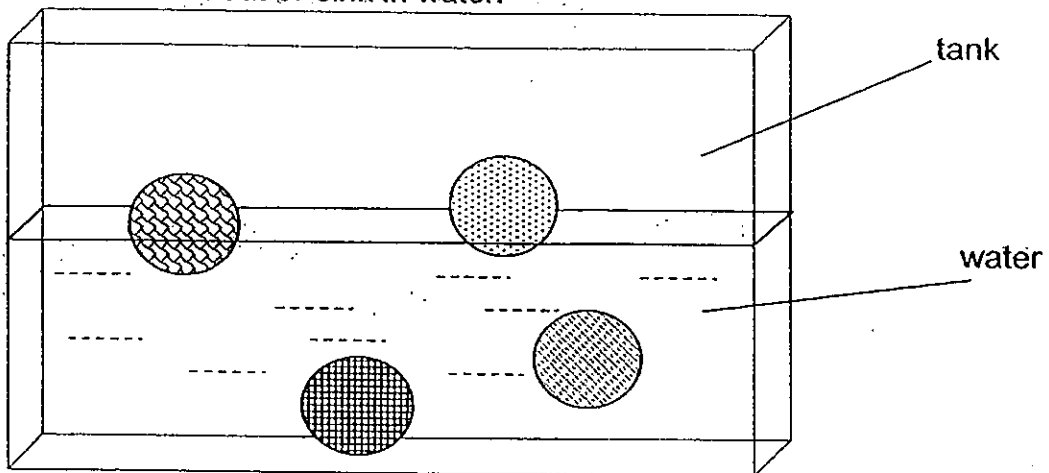

What is/are the variable(s) that he should keep the same to conduct a fair test?

- A: Material of the object
- B: Shape of the object
- C: Colour of the object.
- D: Size of the object

- (1) A only
- (2) A and C only
- (3) B and D only
- (4) A, B and D only

( . . )

7. Four different materials, A, B, C and D, each 10 cm in length, are stretched using the same weight. The increase in the lengths of each material is recorded in the table below.



Materials	Increase in length (cm)
A	5
B	1
C	0
D	3

To launch an object with a catapult, Part X of a catapult has to be elastic. Which material(s) A, B, C or D is/are not suitable to be made into Part X of a catapult?

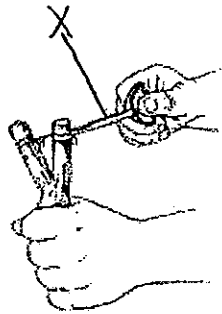

- (1) A only
- (2) C only
- (3) B and C only
- (4) A, B and D only

( )

8. The handle, lid and base of the pot are made of three different materials.

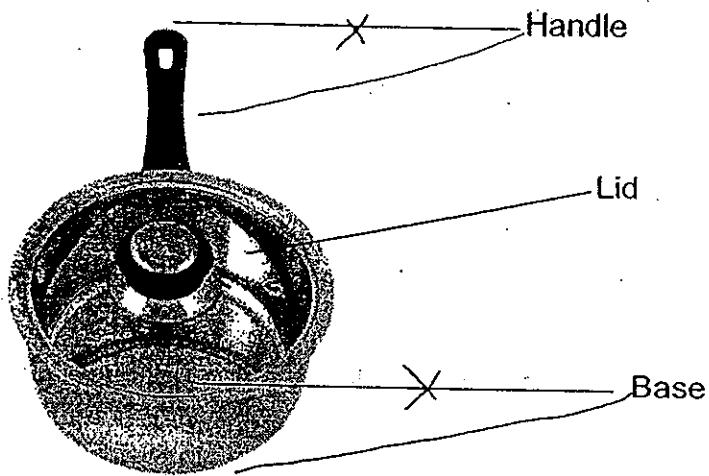

The table below shows the characteristics of materials W, X, Y or Z.

Characteristics	W	X	Y	Z
Strong		✓		
Transparent			✓	
Flexible	✓		✓	
Gets hot easily		✓		✓
Melts easily	✓			✓

Which one of the materials W, X, Y or Z, is best suited to be made into the base of the pot?

- (1) W
- (2) X
- (3) Y
- (4) Z

( )

9. Which one of the following magnets is named wrongly?

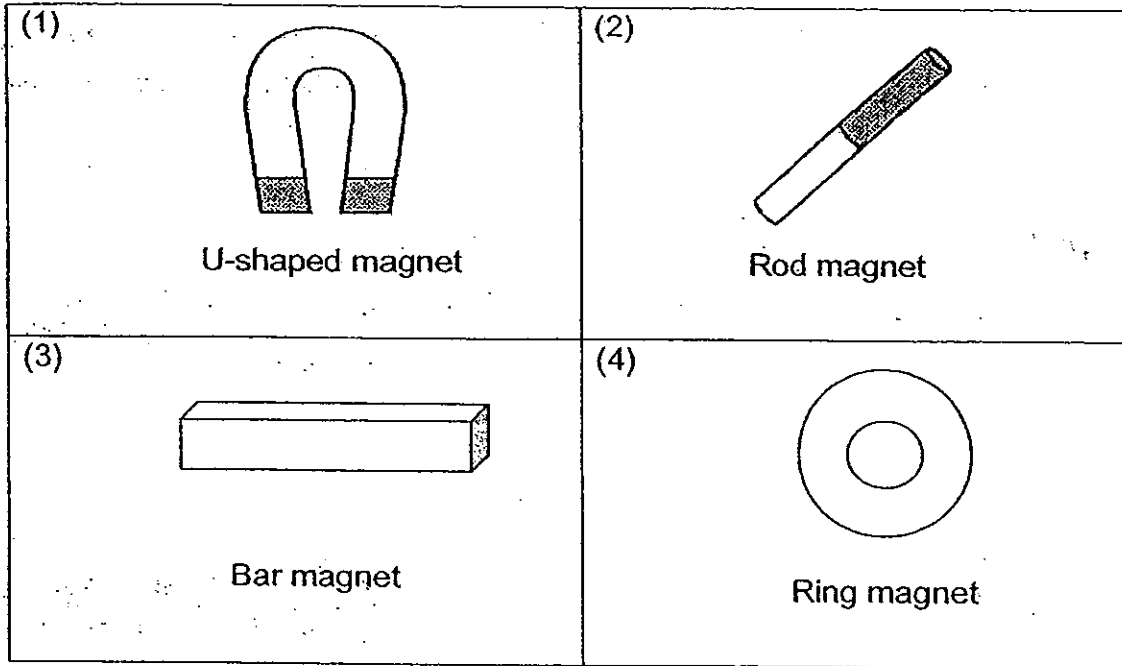

( )

10. Wilson brought a magnet close to a metal bar and he found that it was attracted to the magnet. Wilson then wrote the following statements in his Science journal:

- A: The metal bar could be a magnet.
- B: The metal bar is made of copper or gold.
- C: The metal bar is made of a magnetic material.

Which of the statement(s) is/are correct?

- (1) A only
- (2) B only
- (3) A and C only
- (4) B and C only

( )

11. Rupak has four containers made of different materials. He puts a safety pin into each of four containers. He then tries to use a magnet to slide the safety pin out of the container. Which one of the following will not allow the magnet to retrieve the safety pin?

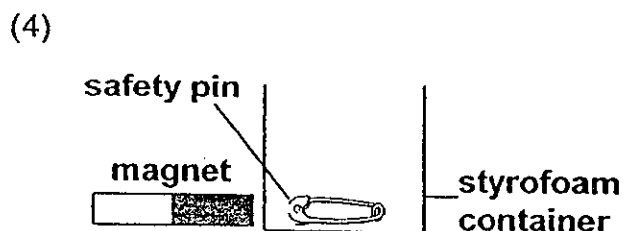
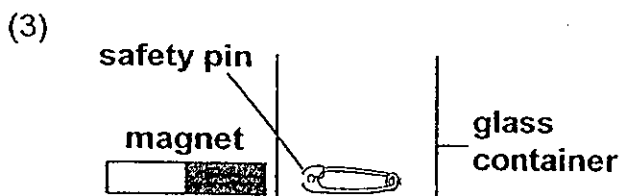
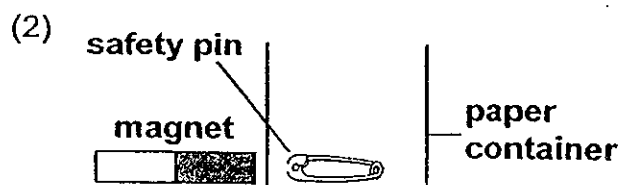
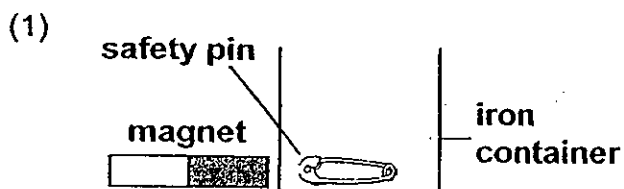

( )

12. Study the arrangement of the magnets below. Which arrangement is not possible?

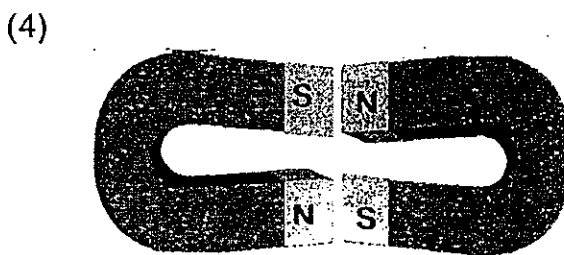
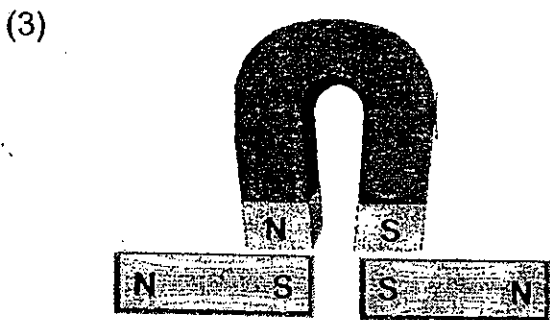
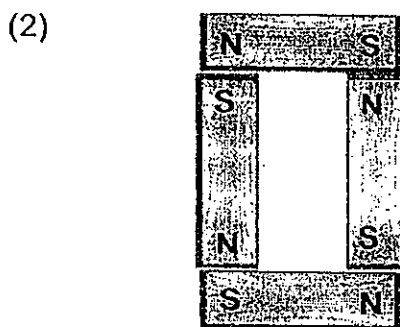
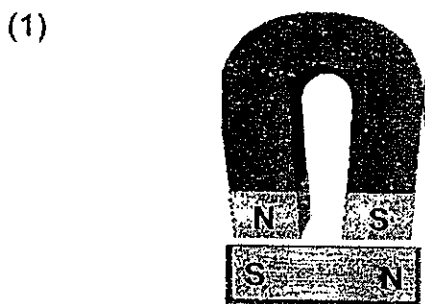

( )



3. Which of the following pairs of objects have been classified correctly?

	Make use of magnets	Does not make use of magnets
(1)	Refrigerator	Clinical thermometer
(2)	Electronic door	Credit card
(3)	Computer	Vacuum cleaner
(4)	Doorbell	Compass

14. Darra sets up an experiment below.

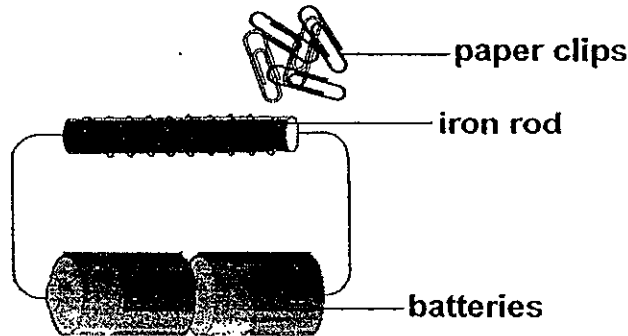

What can Darra do to attract more paper clips to the iron rod?

- A: Remove one battery
  - B: Add one more battery.
  - C: Make more coils round the iron rod.
  - D: Make lesser coils round the iron rod.
- (1) A and C only  
(2) A and D only  
(3) B and C only  
(4) B and D only

15. The diagram below shows a magnet hung from a string.

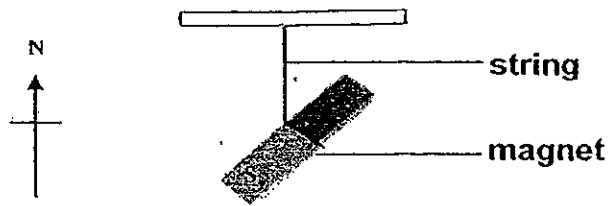

What will happen to the magnet after a few minutes?

- (1) It will spin round and round.
- (2) It will come to rest in the east-west direction.
- (3) It will come to rest in the direction of the Sun.
- (4) It will come to rest in the north-south direction.

(      )

**PART 2 (20 marks)**

Write your answers to questions 16 to 21 in the spaces given.

16. The picture below shows a pair of safety goggles used to protect the wearer's eyes.

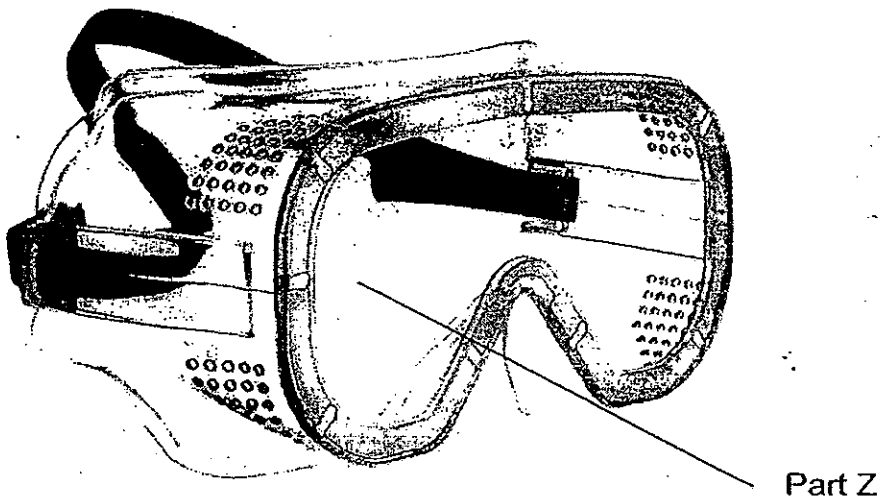

- a) State two properties of the material that was used to make Part Z. (2m)

(i) \_\_\_\_\_

(ii) \_\_\_\_\_

- b) State one possible material that could be used to make Part Z. (1m)

\_\_\_\_\_

17. Three different types of materials, P, Q and R are placed on two wooden stands as shown in the set up below.

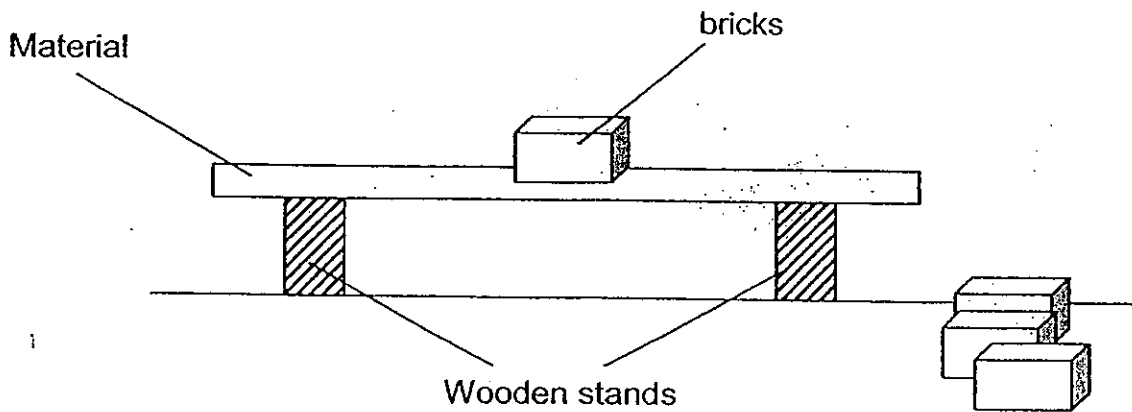

Bricks are added one by one on each material until the material breaks. The number of bricks each material can support before it breaks are recorded in the table below.

Material	Number bricks added before the material breaks
P	8
Q	1
R	3

- a) Which material, P, Q and R is the strongest? (1m)

---

- b) Explain your answer in (a). (1m)

---

---

- c) State one variable that must be kept the same to ensure a fair test. (1m)

---

18. Sam hung one end of four different types of materials W, X, Y and Z of the same size and shape, over a tray of water.

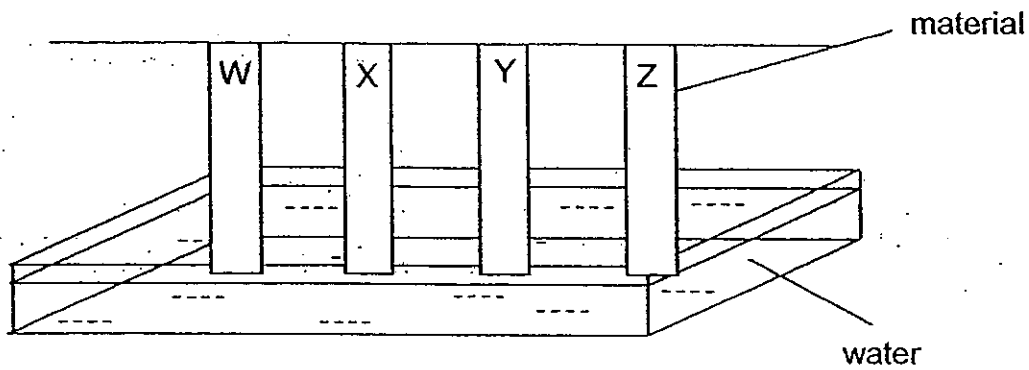

After 30 minutes, he measured the height of the water on each material and recorded the results in the bar graph below.

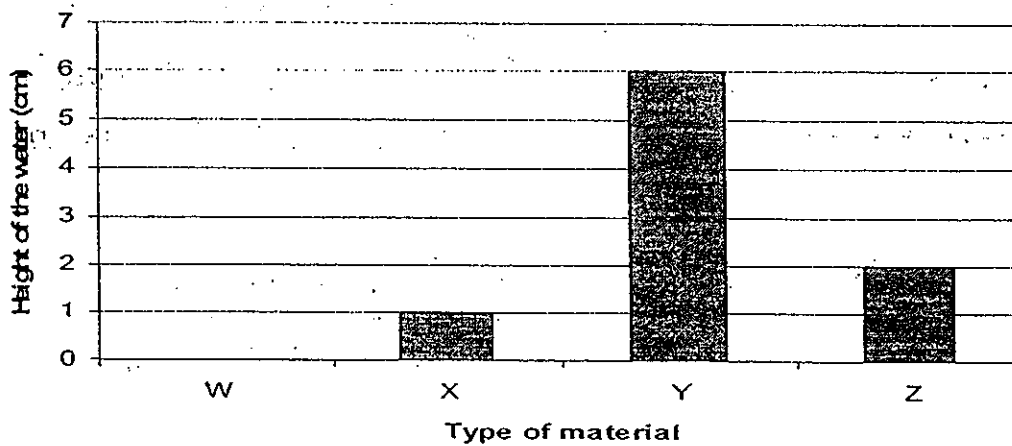

- a) Which variable did he change? (1m)
- 
- b) Based on the results in the table above, which material is most suitable to be made into a raincoat? (1m)
- 
- c) Explain your answer in (b). (1m)
- 
- d) Based on results in the table above, list the materials in order starting with the most absorbent to the least absorbent. (1m)
-

19. Janet wanted to find out if the objects **T**, **U** and **V** are magnets. She placed each object near a magnet, a nail and an ice cream stick. Her observations were recorded in the table below.

	<b>Magnet</b>	<b>Nail</b>	<b>Ice cream stick</b>
Object <b>T</b>	Repel	Attract	No reaction
Object <b>U</b>	Attract	No reaction	No reaction
Object <b>V</b>	No reaction	No reaction	No reaction

- (a) Which of the object(s) is/are definitely magnets? (1m)

---

- (b) What material can **Object U** be made of? Explain your answer. (2m)

---

---

20. Group these materials according to the classification table below. (4m)

Glass	Copper	Steel	Paper
Wood	Nickel	Iron	Cobalt

<b>Magnetic materials</b>

<b>Non-Magnetic materials</b>

21. John used a magnet to stroke Nail A as shown below. He then placed a compass close to the nail. John found that the **south** pole of the nail attracted the **north** pole of the compass needle.

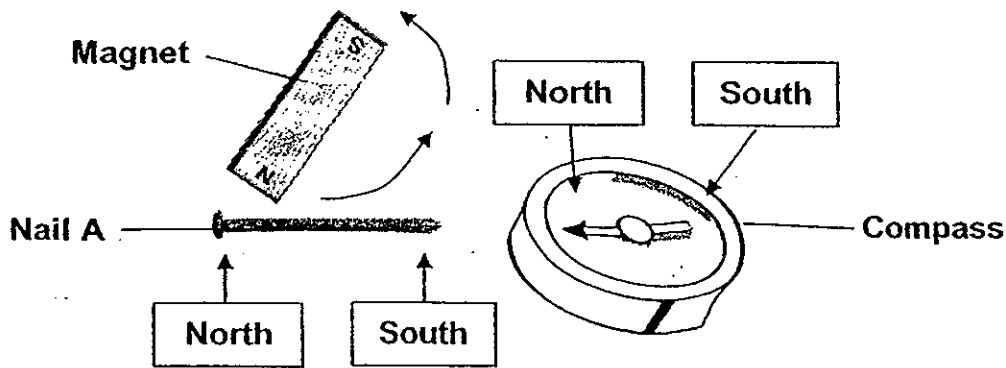

John then stroked Nail B as shown below. He brought the nail close to the compass and found that the **north** pole of the compass needle turned **away** from Nail B as shown below.

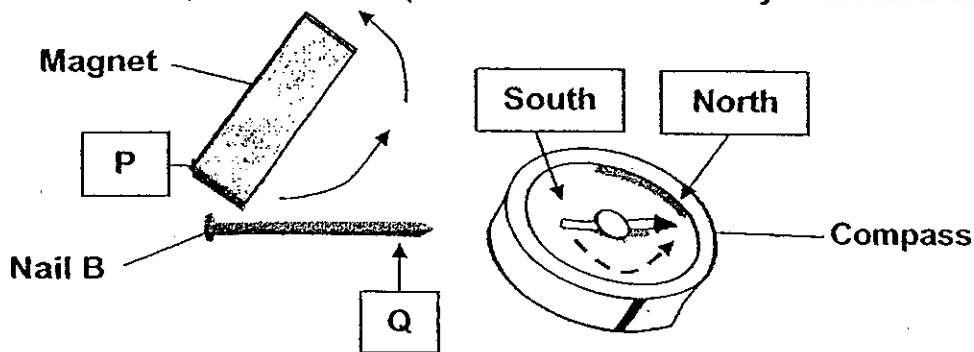

- a) Write 'North' or 'South' in the blanks to indicate the poles for the magnet and the nail.

P: \_\_\_\_\_ (1m)

Q: \_\_\_\_\_ (1m)

- b) Cindy would like to find out which type of nails can make the strongest magnet using the stroking method.

Put a tick (✓) beside the variable (s) that Cindy should keep the same to ensure a fair test. (1m)

- Type of nails used
- Type of the magnets used
- Number of strokes used
- Number of paper clips the nails can attract

- END OF PAPER -

Setters: Mdm Rebecca Lo, Mr K Faizal  
 Vetter: Mdm Fathlon Tawfik





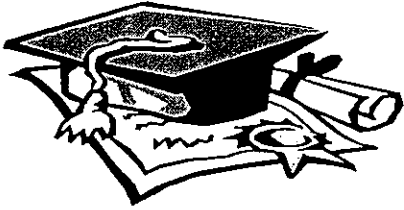

# ANSWER SHEET

---

## EXAM PAPER 2010

**SCHOOL : HENRY PARK PRIMARY**  
**SUBJECT : PRIMARY 3 SCIENCE**

**TERM : CA2**

---

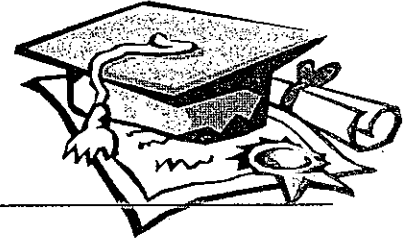

Q1	Q2	Q3	Q4	Q5	Q6	Q7	Q8	Q9	Q10	Q11	Q12	Q13	Q14	Q15
4	4	2	1	3	3	2	2	1	3	1	3	1	3	4

16i) transparent

16ii) Does not break easily when dropped.

16b) Plastic

17a) Material P.

17b) It can support the most number of bricks before it breaks.

17c) The bricks must be the same mass to ensure a fair test.

18a) He changed the type of material.

18b) Material W

18c) It is waterproof and raincoats need to be waterproof to stop the rain wetting us.

18d) Y, Z, X, W

19a) Object T

19b) Iron. Iron is a magnetic material and can be attracted to the magnet but cannot be attracted to the nail and the ice cream stick.

20) Magnetic materials: steel, nickel, iron and cobalt  
Non-magnetic materials: glass, copper, paper and wood.

**21a) P: south**  
**Q: north**

**21b) Type of the magnets used**  
**Number of strokes used**