



NAN HUA PRIMARY SCHOOL
SEMESTRAL ASSESSMENT 2 – 2016
PRIMARY THREE
MATHEMATICS

INSTRUCTIONS TO CANDIDATES

1. Write your name, register number and class in the space provided.
 2. Do not turn over the page until you are told to do so.
 3. Follow all instructions carefully.
 4. Answer all questions.
 5. Shade your answers in the Optical Answer Sheet (OAS) provided for Questions 1 - 15.
-

Marks Obtained

Section	Maximum Marks	Actual Marks
A	30	
B	30	
C	20	
Total	80	

Name : _____ ()

Class : Pr 3 _____

Date : 26 October 2016

Duration: 1 h 45 min

Parent's Signature : _____

Section A : Multiple-Choice Questions (30 marks)

Questions 1 to 15 carry 2 marks each. For each question, four options are given. Only one of them is the correct answer. Make your choice (1, 2, 3 or 4) and shade the correct oval on the Optical Answer Sheet (OAS).

1. In 9 706, the digit _____ is in the hundredsn place.

- (1) 0
- (2) 6
- (3) 7
- (4) 9

()

2. 4 thousands and 50 tens make _____.

- (1) 54
- (2) 450
- (3) 4 050
- (4) 4 500

()

3. The sum of 500 and _____ is 8 530.

- (1) 830
- (2) 8 580
- (3) 8 030
- (4) 9 030

()

4. How many hundreds are there in

- (1) 8
- (2) 28
- (3) 280
- (4) 800

()

5. The product of 8 and _____ is 72.

- (1) 9
- (2) 64
- (3) 80
- (4) 576

()

6. Which of the following has the greatest value?

- (1) 1 ten-dollar note and 6 ten-cent coins
- (2) 6 two-dollar notes and 5 ten-cent coins
- (3) 3 five-dollar notes and 1 fifty-cent coin
- (4) 1 ten-dollar note and 4 twenty-cent coins

()

7. What is the time shown on the clock below?

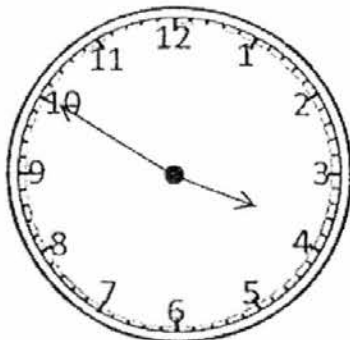

- (1) 10 minutes to 3
- (2) 10 minutes past 3
- (3) 20 minutes past 10
- (4) 10 minutes before 4

()

8. Grace used a 45-cm ribbon to tie Gift A. Eileen used another ribbon which was 3 times as long to tie Gift B. What was the length of ribbon Eileen used?

- (1) 15 cm
- (2) 90 cm
- (3) 135 cm
- (4) 180 cm

()

9. What is the mass of the pineapple shown below?

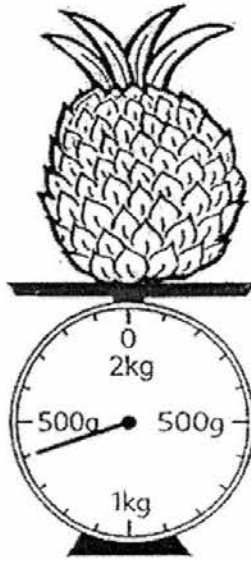

- (1) 400 g
- (2) 900 g
- (3) 1 400 g
- (4) 1 450 g

()

10. Look at the diagram below. How much more water is required to make 2ℓ of water?

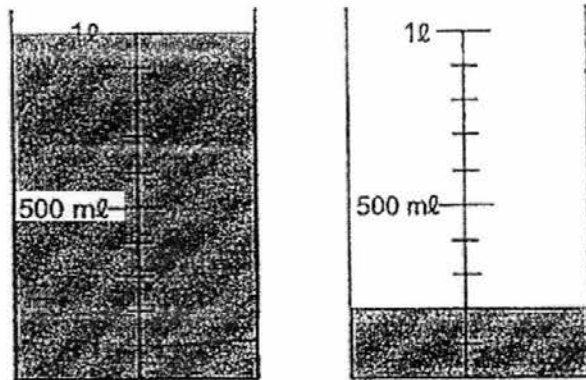

- (1) 200 ml
- (2) 800 ml
- (3) 1 000 ml
- (4) 1 200 ml

()

11. Which of the following figure(s) below show(s) $\frac{1}{4}$ shaded ?

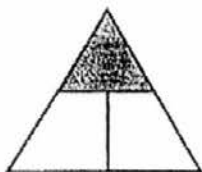

(A)

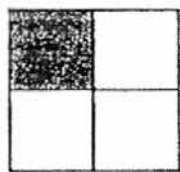

(B)

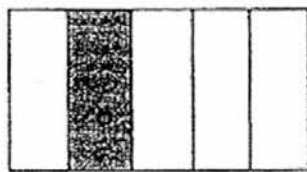

(C)

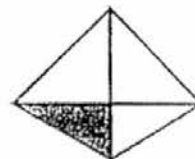

(D)

- (1) B only
- (2) B and C
- (3) B and D
- (4) A, B and D

()

12. In the figure below, name the line which is parallel to CD.

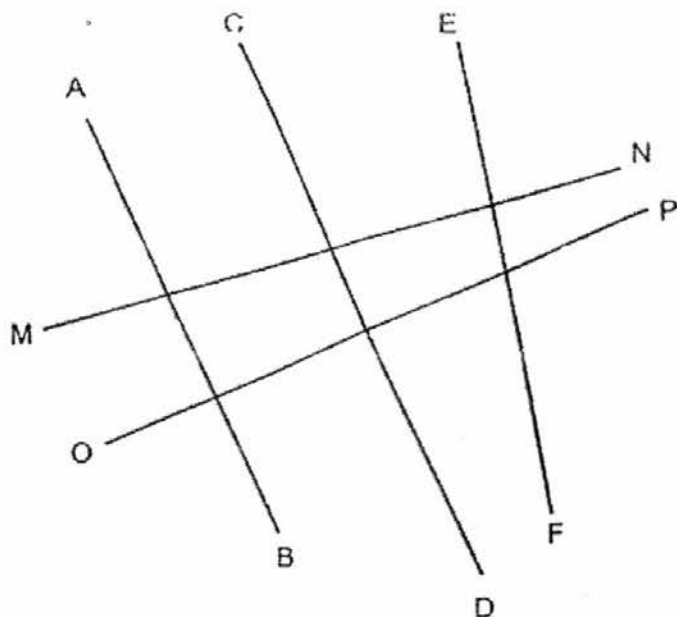

- (1) Line AB
- (2) Line EF
- (3) Line MN
- (4) Line OP

()

The graph below shows the number of newspapers sold by Mr Tan from Monday to Friday. Study the graph carefully and answer Questions 13 and 14.

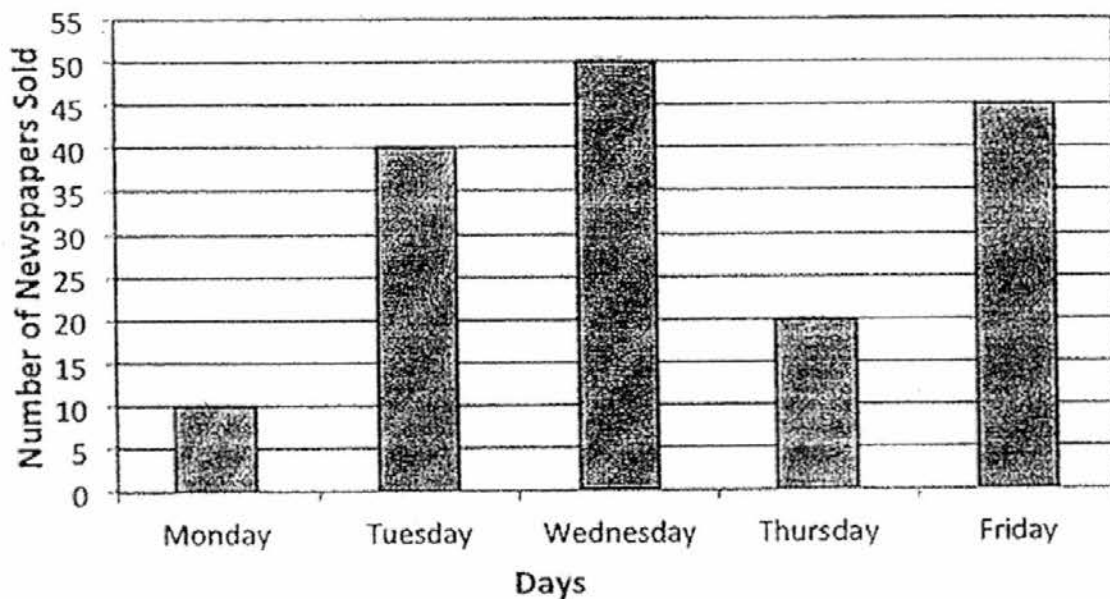

13. How many more newspaper did he sell on Wednesday than on Monday?

- (1) 10
- (2) 40
- (3) 50
- (4) 60

()

14. On which day did Mr Tan sell **twice** as many newspapers as he did than on Thursday?

- (1) Monday
- (2) Tuesday
- (3) Wednesday
- (4) Friday

()

15. In the figure below, how many angles inside the figure are smaller than a right angle?

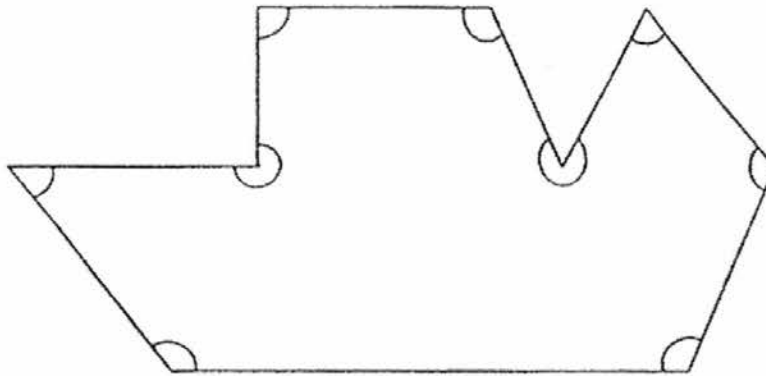

- (1) 1
- (2) 2
- (3) 3
- (4) 4

()

Section B : Short Answer Questions (30 marks)

Questions 16 to 25 carry 1 mark each. Questions 26 to 35 carry 2 marks each. For each question, show your workings clearly in the space below and write your answer in the box provided. Give your answer in the unit stated.

16. Write 7 415 in words.

Ans:

17. Complete the following number pattern.

4 265 , 4 274 , 4 283 , _____ , 4 301

Ans:

--

18. Find the quotient of 947 and 7.

Ans:

--

19. Arrange these numbers in order. Begin with the **greatest** number.

5 186	5 126	6 518	5 268
-------	-------	-------	-------

--	--	--	--

Greatest

20. $400 \times 8 = \underline{\hspace{2cm}}$

Ans:

21. $3 \times 4 = 2 \times \boxed{?}$

What is the missing number?

Ans:

22. How many twenty-cent coins make \$3.00?

Ans:

twenty-cent coins

23. $\$36.70 - \$4.90 = \underline{\hspace{2cm}}$

Ans: \$

24. Express the length in **metres** and **centimetres**.

$$860 \text{ m} = \underline{\quad\quad} \text{ m } \underline{\quad\quad} \text{ cm}$$

Ans: m cm

25. Edison cycled 1 km 20 m to the library and then cycled 300 m to the park.
How far did he cycle in total? Express your answer in **metres**.

Ans: m

26. Mary collected a total of 126 seashells. She packed them equally into bags of 9.
How many bags of seashells did she have?

Ans: bags

27. $\frac{1}{3} - \frac{2}{9} =$

Ans:

28. Look at the diagram below. If the apple has a mass of 75 g, find the mass of one rubber ball. (The rubber balls are of equal mass.)

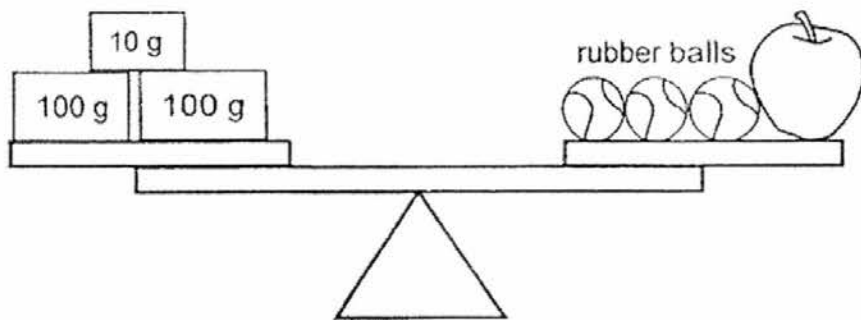

Ans: g

29. A jug contained 140 ml of orange syrup. Justin poured 2 cans of soda into the jug. Each can contained 330 ml of soda. What was the total volume of orange soda in the jug?

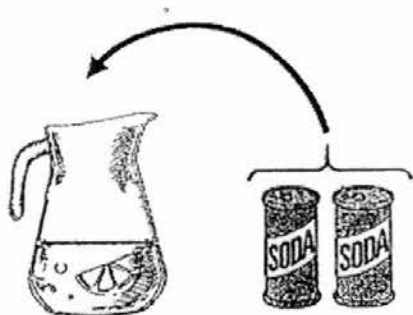

Ans: ml

30. Mr Raju requires 6 square carpets to completely cover the floor of his bedroom. Each square carpet has a length of 3 m, what is the area of the bedroom floor?

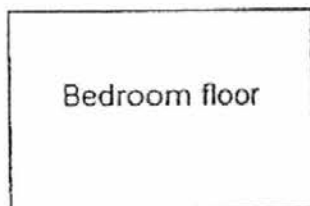

Ans: m²

31. Look at the figure below. If the length is twice as long as its breadth, find the perimeter of the rectangle. The figure is not drawn to scale.

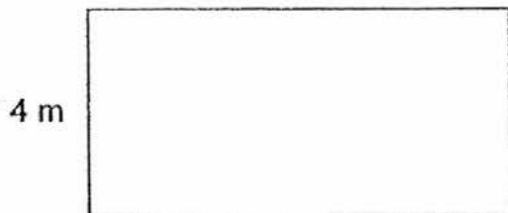

Ans: m

32. Arrange these fractions in order. Begin with the greatest fraction.

$$\frac{1}{5}, \frac{1}{7}, \frac{9}{10}$$

Ans:
greatest

The graph below shows the amount of money Roslan saved over six months. Study the graph carefully and answer Question 33.

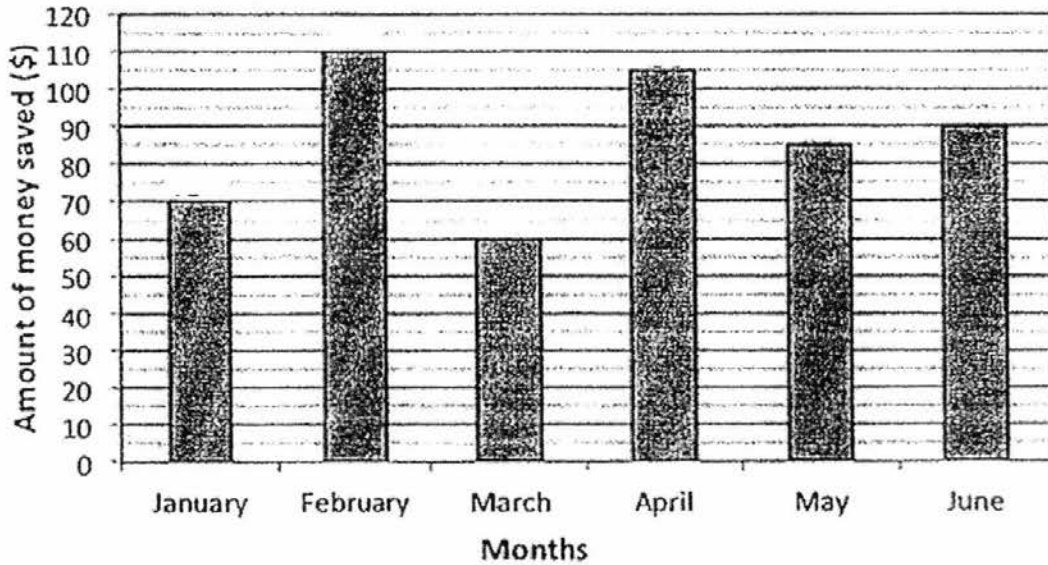

33. Roslan wanted to buy a mobile phone that cost \$200. If he started saving in January, which was the earliest month he would have enough money to buy it?

Ans:

34. Draw the minute hand on the clock below to show 5 minutes to 8.

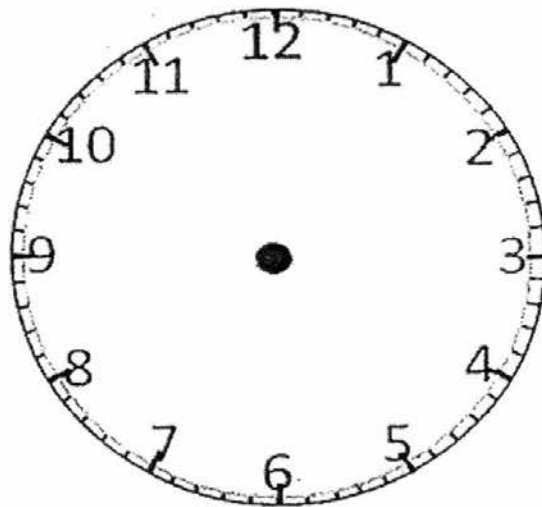

35. Look at the letters below.
List down the letter(s) that has/ have perpendicular lines in them.

M A T H S

Ans:

Section C: (5 x 4 marks)

Answer all the questions. All number sentences, statements and workings must be clearly shown.

36. 3 672 people visited the museum on Saturday.
There were 510 more visitors on Sunday than on Saturday.
How many people visited the museum altogether over the weekend?
37. Mrs Lim baked 241 egg tarts.
She packed them into boxes which can hold 4 egg tarts each.
What was the least number of boxes that she will need to pack all the egg tarts?

38. Wei Ming and Samuel had a total of \$102.
After Wei Ming spent \$6 on food, he had twice as much money as Samuel.
How much money did Samuel have?

39. Salmah left home for the cinema at 2.00 p.m.
She arrived at the cinema 35 minutes later and then watched a movie that
was 1 h 50 min long.

- a) Complete the timeline below by filling in the missing time.

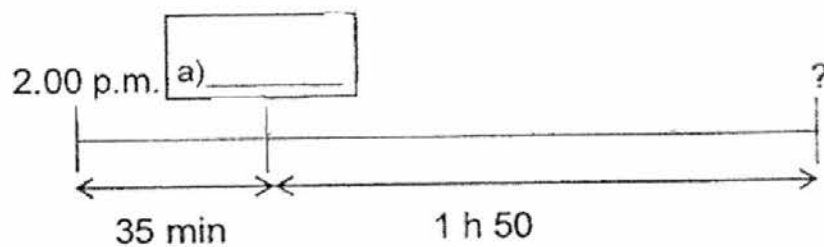

- b) What time did the movie end?

40. A piece of paper had a length of 15 cm and breadth of 10 cm. Four identical squares with sides of 2 cm were cut out from the corners as shown.

(a) What was the area of the paper before it was cut?

(b) What was the area of the paper after the four corners were cut?

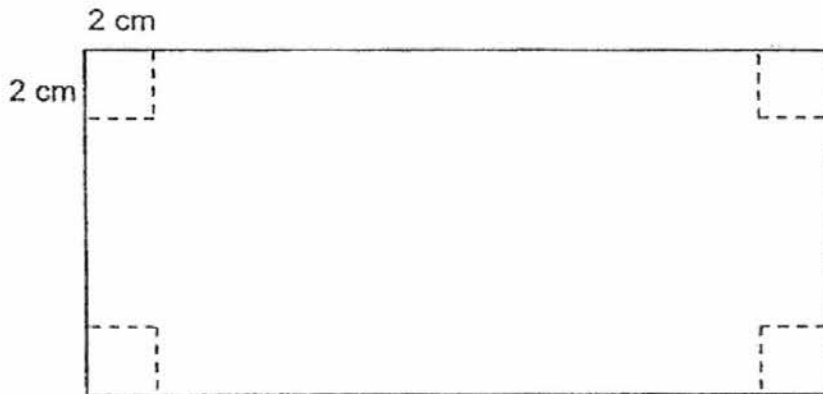

Check your work carefully....

EXAM PAPER 2016 (P3)

SCHOOL : NAN HUA

SUBJECT : MATHEMATICS

TERM : SA2

Q1	Q2	Q3	Q4	Q5	Q6	Q7	Q8	Q9	Q10
3	4	3	2	1	3	4	3	3	2
Q11	Q12	Q13	Q14	Q15					
1	1	2	2	2					

16) Seven thousand, four hundred and fifteen

17) 4292 18) 135 19) 6518, 5268, 5186, 5125 20) 3200 21) 6

22) 15 23) \$31.80 24) 8 m 60cm 25) 1320m 26) 14 27) $\frac{1}{9}$

28) $210\text{g} - 75\text{g} = 135\text{g}$

$$135\text{g} \div 3 = 45\text{g}$$

29) $330\text{ml} \times 2 = 660\text{ml}$

$$660\text{ml} + 140\text{ml} = 800\text{ml}$$

30) $6 \times 9 = 54 \text{ m}^2$

31) perimeter = $8 + 8 + 4 + 4 = 24\text{m}$

32) $\frac{9}{10}, \frac{1}{5}, \frac{1}{7}$

33) March

34)

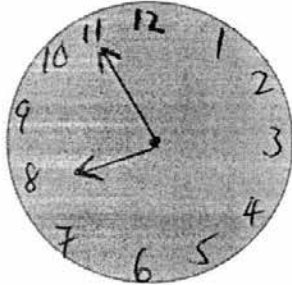

35) T, H

36) $3672 + 510 = 4182$

$$4182 + 3672 = 7854$$

7854 people visited the museum over the weekend.

37) $241 \div 4 = 60r1$

$$60 + 1 = 61$$

The least number of boxes is 61.

38) $\$102 - 6 = \96

$$\$96 \div 3 = \$32$$

Samuel have \$32

39) a) 2.35p.m.

b) The movie end at 4.25p.m.

40) a) The area of the paper before cut is 150cm^2

b) $(2 \times 2 = 4\text{ cm}^2)$

$$(4 \times 4 = 16\text{cm}^2)$$

$$(150 - 16 = 134\text{cm}^2)$$

Area is now 134cm^2