

**Tao Nan School**

**Primary 3 Mathematics End-of-Year Examination 2010**

Name: \_\_\_\_\_ ( )

Date: 28 October 2010

Class: Primary 3 ( )

Time: 8.00 a.m. – 9.00 a.m.

Parent's Signature: \_\_\_\_\_

Marks: \_\_\_\_\_ / 80

Booklet A	10
Booklet B	40
Paper 1	50

**Paper 1**

**Paper 1** comprises **Booklet A** and **Booklet B**.

Time for Paper 1 is **1 hour**

Do not open this booklet until you are told to do so.

Read and follow all instructions carefully.

Answer all the questions.

Paper 1: Booklet A (10 marks)

Questions 1 to 10 carry 1 mark each. For each question, four options are given. One of them is the correct answer. Make your choice (1, 2, 3, or 4). Shade the correct oval on the Optical Answer Sheet (OAS).

1. In 3624, the value of the digit '6' is \_\_\_\_\_.

- (1)  $6 \times 1$
- (2)  $6 \times 10$
- (3)  $6 \times 100$
- (4)  $6 \times 1000$

2.  $7 + 7 + 7 + 7 + 7 + 7 = \underline{\quad} \times 7$

- (1) 7
- (2) 6
- (3) 56
- (4) 42

3. The time shown on the clock is \_\_\_\_\_.

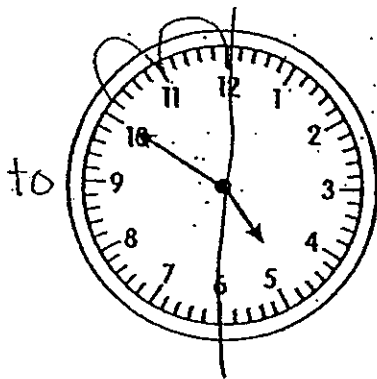

- (1) 10 minutes to 4
- (2) 10 minutes to 5
- (3) 10 minutes past 4
- (4) 10 minutes past 5

4. The difference between 5570 and 3000 is the same as the difference between \_\_\_\_\_ and 570.

- (1) 570
- (2) 2000
- (3) 2570
- (4) 3140

5. Which one of the following fruit has a mass of about one kilogram?



- (1) an apple
- (2) a pear
- (3) a papaya
- (4) a strawberry

6. Hongying bought 10 m of ribbon.  
She used 150 cm of it and cut the rest equally into 5 pieces.  
The length of each of the 5 pieces is \_\_\_\_\_ cm.

- (1) 50
- (2) 140
- (3) 170
- (4) 850

7. The figure is made up of small and big rectangles.  
What fraction of the figure is shaded?

(1)  $\frac{2}{8}$

(2)  $\frac{2}{7}$

(3)  $\frac{2}{6}$

(4)  $\frac{2}{5}$

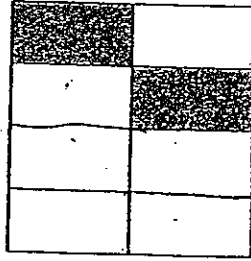

8. The picture shows a bottle of jam on a weighing scale.  
If the empty bottle weighs 75 g, the mass of the jam is \_\_\_\_ g.

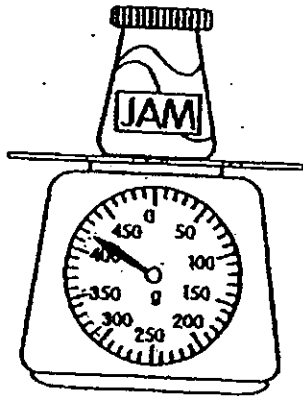

(1) 345

(2) 355

(3) 420

(4) 495

9.  $\frac{3}{5}$  is equivalent to \_\_\_\_\_.

(1)  $\frac{2}{10}$

(2)  $\frac{4}{10}$

(3)  $\frac{6}{10}$

(4)  $\frac{8}{10}$

10.  $\boxed{?} \div 6 = 6 \text{ R } 3$

What is the missing number?

(1) 12

(2) 15

(3) 36

(4) 39

---

End of Booklet A

Tao Nan School

Primary 3 Mathematics End-of-Year Examination 2010

Name: \_\_\_\_\_ ( )

Class: Primary 3 ( )

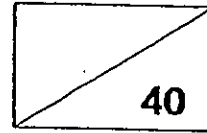

Paper 1: Booklet B (40 marks)

Each question carries 2 marks. Write your answers in the boxes provided. Give your answers in the units stated.

11. Write nine thousands, two hundreds, two tens and eighteen ones in numerals.

Ans:

12. Form the greatest 4-digit odd number using each digit below once.

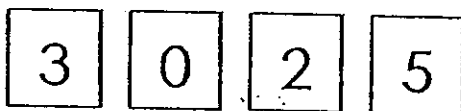

13. 4505 is 100 less than \_\_\_\_\_

Ans:

14. The product of 703 and 4 is \_\_\_\_\_.

Ans:

15. What is the missing number ?

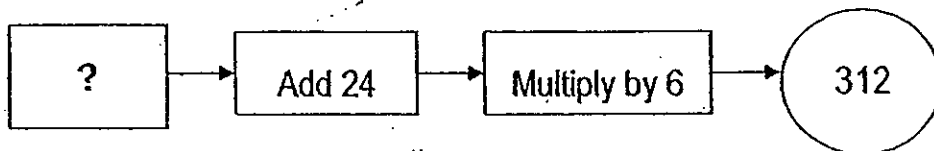

Ans:

16. It was Wednesday 2 days ago. What day of the week will it be 11 days from today?

Ans:

17. A movie lasted 2 hours 10 minutes. It ended at 9.00 p.m.  
At what time did the movie start?

Ans:  p.m.

18. Mother bought 2 cooking pots at \$29.90 each.  
She gave the cashier a hundred-dollar note.  
How much change did Mother receive?

\$

19. Huihui had a five-dollar note, 4 fifty-cent coins and some  
twenty-cent coins. If she had \$9.60 altogether, how many  
twenty-cent coins did she have?

Ans:



20. Devi jogged 3km 885 m. Kumar jogged 75 metres more.  
How far did both of them jog?

Ans:

21. What is the mass of the box?

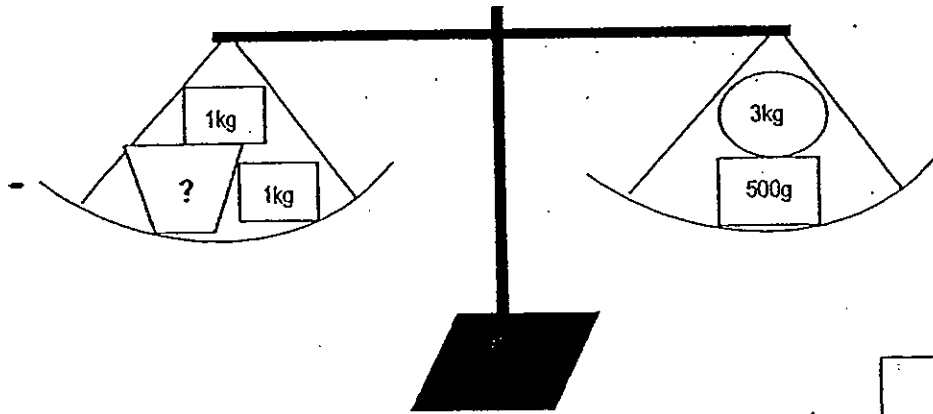

Ans:

22. Look at the angles. Angle \_\_\_\_\_ is the **smallest**.

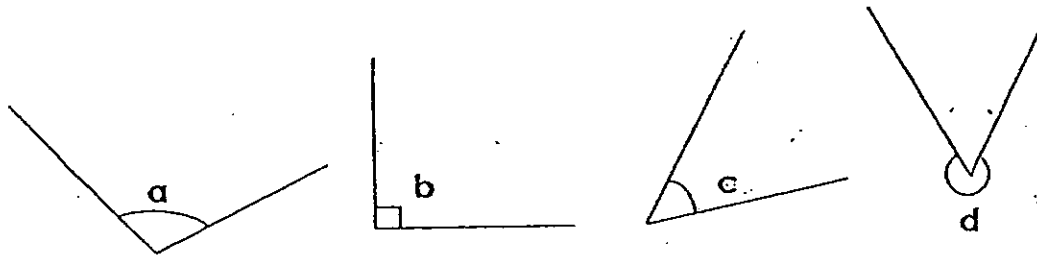

Ans: Angle

23. Weiming took 3 h 45 min to complete his AdventureWeek! project.  
How many minutes are there in 3 h 45 min?

Ans:

24. How many angles are there **inside** the figure shown below?

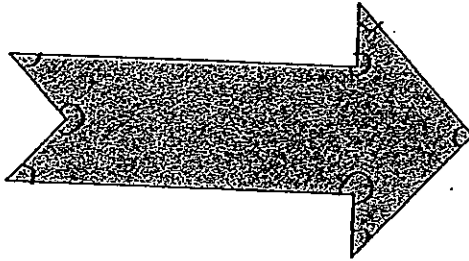

Ans:

25. Find the shaded area of the figure shown.

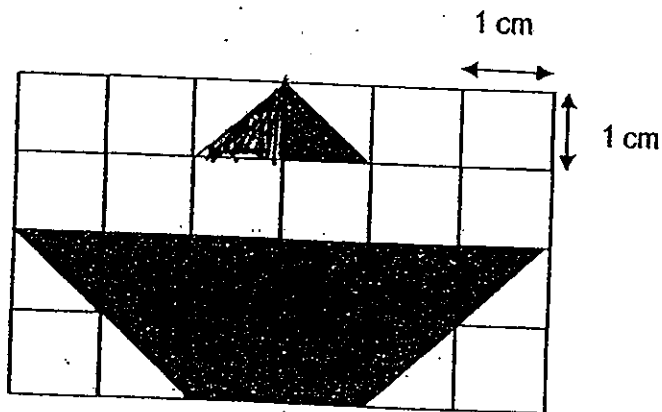

Ans:

26. If  $\textcircled{0} \textcircled{0} + \heartsuit \heartsuit \heartsuit \heartsuit \heartsuit \heartsuit = 540$

$\textcircled{0} + \heartsuit \heartsuit = 200$

then  $\heartsuit = \underline{\hspace{2cm}}$

Ans:

27. How many more triangles must be shaded so that  $\frac{1}{2}$  of the figure is shaded?



Ans:

28. There are 15 vehicles. Some are cars and some are motorcycles. If there are 36 wheels in all, how many motorcycles are there?

Ans:

Use the bar graph below to answer questions 29 and 30.

The bar graph shows the number of visitors at a Food Fair in a week.

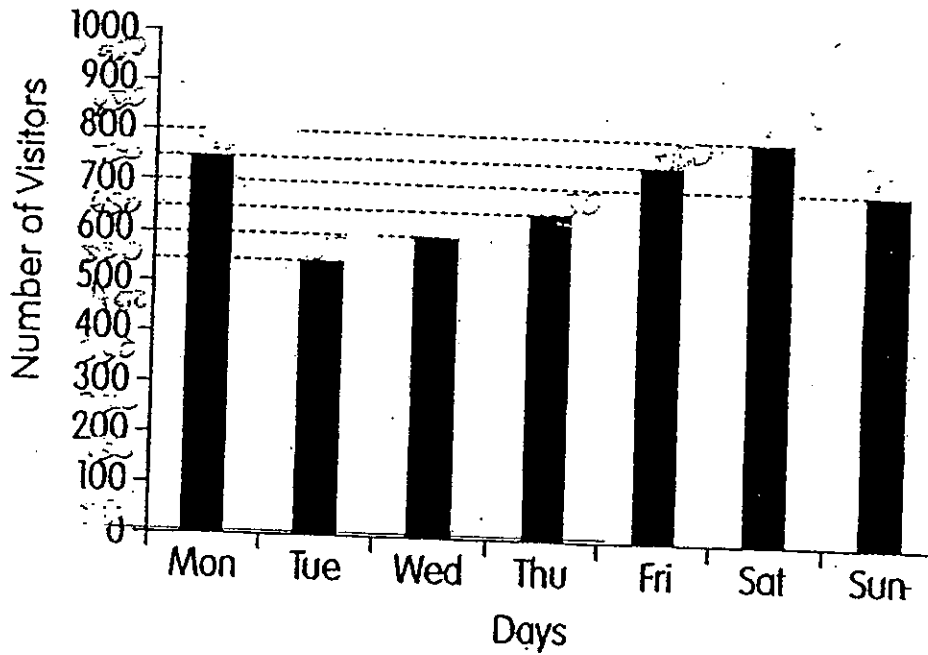

29. How many fewer people visited the Food Fair on Monday than on Saturday and Sunday?

Ans:

30. If there were 545 adults at the Food Fair on Friday, how many children were there?

Ans:

Tao Nan School

Primary 3 Mathematics End-of-Year Examination 2010

Paper 2

Name: \_\_\_\_\_ ( )

Date: 28 October 2010

Class: Primary 3 ( )

Time: 10.30 a.m. – 11.30 a.m.

Parent's Signature: \_\_\_\_\_

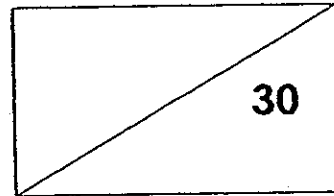

---

Time for Paper 2 is **1 hour**.

Do not open this booklet until you are told to do so.

Read and follow all instructions carefully.

Answer all the questions.

**Each question carries 3 marks.**

**Show all your working and statement clearly in the spaces provided.**

---

1. Sulin takes 5 minutes to fold 3 paper cranes.  
She needs to fold 9 of them.  
If she starts at 6.25 p.m., at what time will she complete folding all the 9 paper cranes?

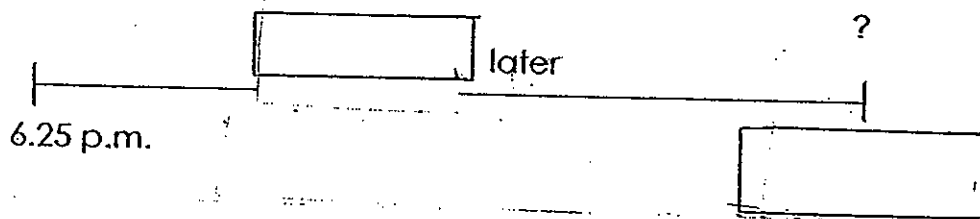

Ans: \_\_\_\_\_

2. Mrs Tan bought 100 muffins for her pupils.  
If she gave each pupil 3 muffins, she would need 8 more muffins.  
How many pupils were there?

Ans: \_\_\_\_\_

3. The figure below is made up of three rectangles.  
Find the perimeter of the figure.

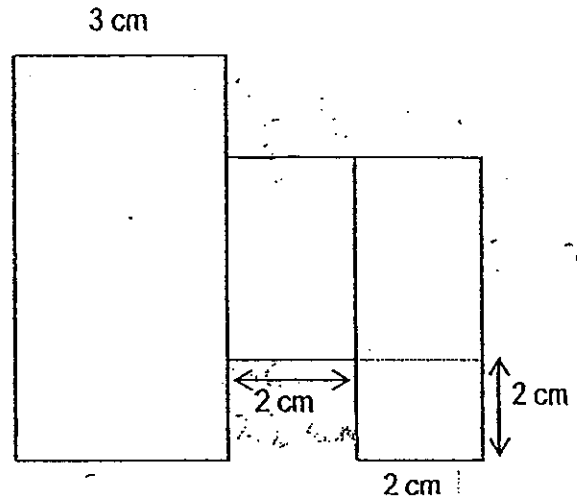

Ans: \_\_\_\_\_

4. Bob ate  $\frac{3}{11}$  of a pizza. He gave half of the remainder to Tom.  
What fraction of the pizza was left?

Ans: \_\_\_\_\_

5. Anne, Kelly and Suzie shared \$390. Anne had twice as much money as Kelly. Kelly had three times as much money as Suzie. How much money did Anne have?

Ans: \_\_\_\_\_

6. Clara had 3 more biscuits than Alex.  
Timmy had 4 fewer biscuits than Alex.  
If ~~25~~ Clara had 19 biscuits, how many biscuits did Timmy have?

Ans: \_\_\_\_\_



7. 4 square cardboards of the same size are placed together to form a large rectangle as shown below.  
Find the area of the large rectangle.

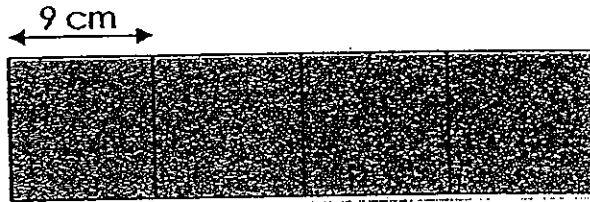

Ans: \_\_\_\_\_

- 
8. Some fruit trees are planted at equal distance from each other.  
The distance between the 2<sup>nd</sup> tree and the 4<sup>th</sup> tree is 16 m.  
Find the distance between the 1<sup>st</sup> and the 7<sup>th</sup> fruit tree.

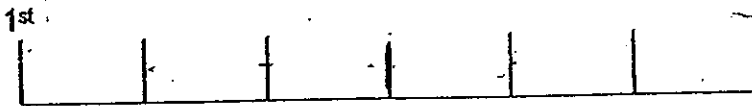

Ans: \_\_\_\_\_

9. In a tin, there are 410 marbles in 3 different colours.  
There are 3 times as many blue marbles as green marbles.  
There are 42 red marbles. How many blue marbles are there?

Ans: \_\_\_\_\_

10. Study the pattern. Each figure is made up of tiles.



Figure 1



Figure 2

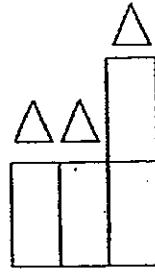

Figure 3

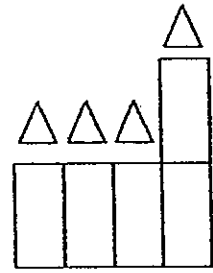

Figure 4

- (a) How many rectangular tiles are there in Figure 12 ?
- (b) How many more rectangular tiles than triangular tiles are there in Figure 100 ?

Ans: (a) \_\_\_\_\_

(b) \_\_\_\_\_

End-of-Paper



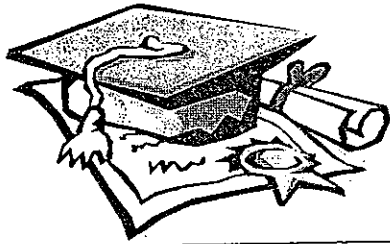

# ANSWER SHEET

**EXAM PAPER 2010**

**SCHOOL : TAO NAN PRIMARY**  
**SUBJECT : PRIMARY 3 MATHEMATICS**

**TERM : SA2**

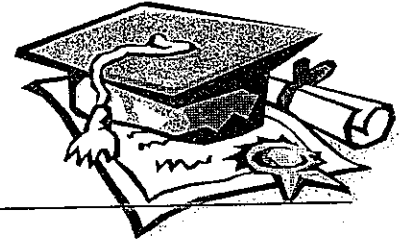

Q1	Q2	Q3	Q4	Q5	Q6	Q7	Q8	Q9	Q10
3	2	2	4	3	3	1	1	3	4

- 11)9238                      12)5203                      13)4605                      14)2812                      15)28
- 16)Tuesday                17)6.50p.m.                18)\$40.20                    19)13                        20)7845m
- 21)1kg 500g                22)C                         23)225 min                 24)8                         25)9cm<sup>2</sup>
- 26)70                        27)5                         28)12                        29)750                       30)205

**Paper 2**

1)6.40 p.m.

$$2)100 + 8 = 108$$
$$108 \div 3 = 36$$

There were 36 pupils.

$$3)3\text{cm} + 2\text{cm} + 2\text{cm} + 2\text{cm}$$
$$5\text{cm} + 2\text{cm} + 2\text{cm} + 2\text{cm}$$
$$2\text{cm} + 2\text{cm} + 3\text{cm} + 9\text{cm}$$
$$= 36\text{cm}$$

The perimeter of the figure is 26cm.

$$4)3/11 + 4/11 = 7/11$$
$$1 - 7/11 = 11/11 - 7/11 = 4/11$$

4/11 of the pizza was left.

$$5)\$390 \div 10 = \$39$$
$$\$39 \times 6 = \$234$$

Anne had \$234.

$$6)19 - 3 = 16$$
$$16 - 4 = 12$$

Timmy had 12 biscuits.

$$7)\text{Area} = L \times B$$

$$= 36\text{cm} \times 9\text{cm} = 324\text{cm}^2$$

They area of the large rectangle is 324cm<sup>2</sup>

$$8)16\text{m} \times 2 = 32\text{m}$$

$$32\text{m} + 16\text{m} = 48\text{m}$$

The distance between the 1<sup>st</sup> and the 7<sup>th</sup> tree is 48m.

$$9)410 - 42 = 368$$

$$338 \div 4 = 92$$

$$92 \times 3 = 276$$

There are 276 blue marbles.

10)a)There are 13 rectangular tiles in figure 12.

$$b)101 - 100 = 1$$

There are 1 more rectangular tiles in Figure 100.

