



**MARIS STELLA HIGH SCHOOL (PRIMARY)**

**SEMESTRAL ASSESSMENT 1**

**Primary 3 MATHEMATICS**

**11 MAY 2015**

**BOOKLET A**

17 questions

30 marks

Total time for Booklets A and B: 1 h 45 min

**NAME :** \_\_\_\_\_ (     )

**CLASS : PRIMARY 3** \_\_\_\_\_

**DO NOT OPEN THIS BOOKLET UNTIL YOU ARE TOLD TO DO SO.**

**FOLLOW ALL INSTRUCTIONS CAREFULLY.**

**ANSWER ALL QUESTIONS.**

**SECTION A: 30 marks**

**Questions 1 to 4 carry 1 mark each. Questions 5 to 17 carry 2 marks each. For each question, four options are given. One of them is the correct answer. Make your choice (1, 2, 3 or 4). Shade the correct oval (1, 2, 3 or 4) on the Optical Answer Sheet.**

1. In 7489, the digit 4 stands for \_\_\_\_\_.

- (1) 4 x 1
- (2) 4 x 10
- (3) 4 x 100
- (4) 4 x 1000

2. 

?
---

 tens + 450 = 6000

What is the missing number in the box?

- (1) 645
- (2) 555
- (3) 455
- (4) 55

3. In 8572, the digit 8 is in the \_\_\_\_\_ place.

- (1) ones
- (2) tens
- (3) hundreds
- (4) thousands

4. What is the sum of  $6 \times 7$  and  $8 \times 9$ ?

- (1) 30
- (2) 42
- (3) 72
- (4) 114

5. Which is the **shortest** line?

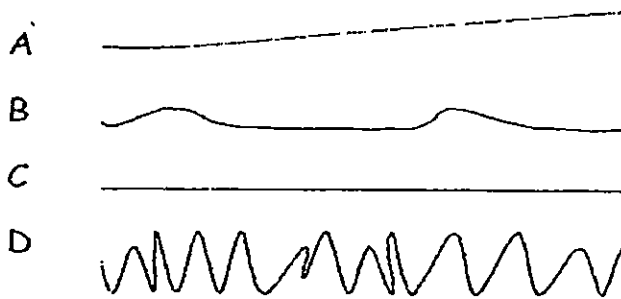

- (1) A
- (2) B
- (3) C
- (4) D

6.  $\boxed{?} \div 7 = 4 \times 2$

What is the missing number in the box?

- (1) 6
- (2) 8
- (3) 42
- (4) 56

7. The time shown on the clock is 15 minutes faster than the actual time.

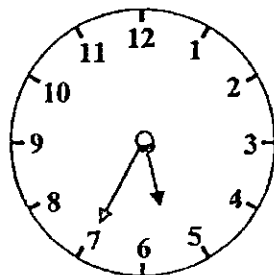

What is the actual time?

- (1) 5.20
- (2) 5.22
- (3) 5.35
- (4) 5.50

8. Derek has \$345. He has three times as much money as Nigel. How much money does Nigel have?
- (1) \$115
  - (2) \$230
  - (3) \$1025
  - (4) \$1035

9. Look at the diagram below.

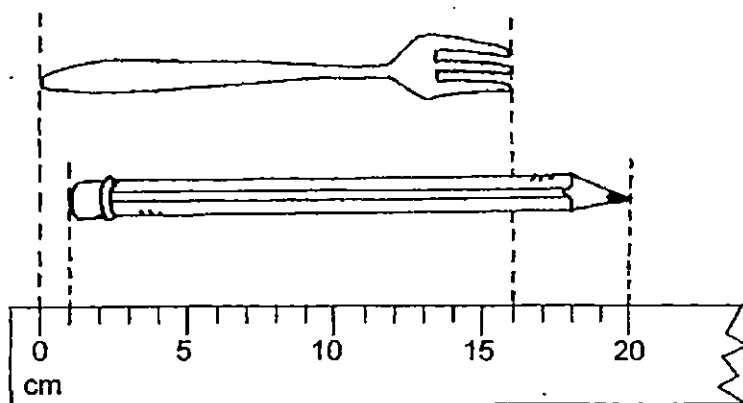

The pencil is \_\_\_\_\_ cm longer than the fork.

- (1) 20
  - (2) 16
  - (3) 3
  - (4) 4
10. Salim earns \$50 a day. He works 7 days a week. He spends \$12 and saves the rest each day. How much does he save in 1 week?
- (1) \$38
  - (2) \$84
  - (3) \$266
  - (4) \$350

11. The figure below is cut into 6 equal parts.

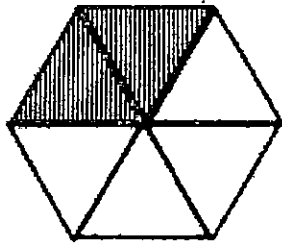

John removes 2 parts from the figure.  
What fraction of the figure is left?

- (1)  $\frac{1}{3}$
- (2)  $\frac{2}{4}$
- (3)  $\frac{2}{6}$
- (4)  $\frac{4}{6}$
12. There are 18 pages in Tom's photo album.  
He arranged 6 photos on each page.  
The last 2 pages were empty.  
How many photos are there in the photo album altogether?
- (1) 12
- (2) 24
- (3) 96
- (4) 108
13. Sam has ten 20¢ coins and some 50¢ coins  
All these coins add up to \$6.  
How many 50¢ coins does Sam have?
- (1) 12
- (2) 8
- (3) 3
- (4) 4

14. Anna wants to give 27 stickers to each of her 8 friends.  
She needs 18 more stickers.  
How many stickers does she have?

- (1) 198
- (2) 202
- (3) 216
- (4) 234

15. Look at the diagram carefully.

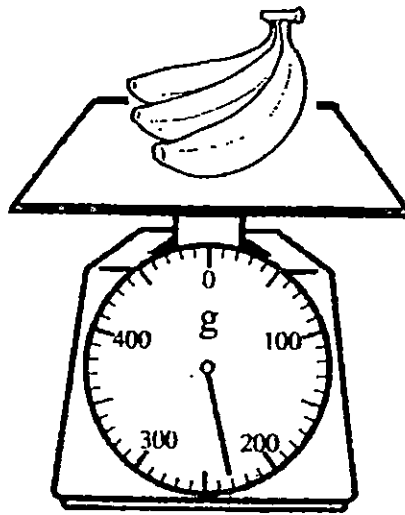
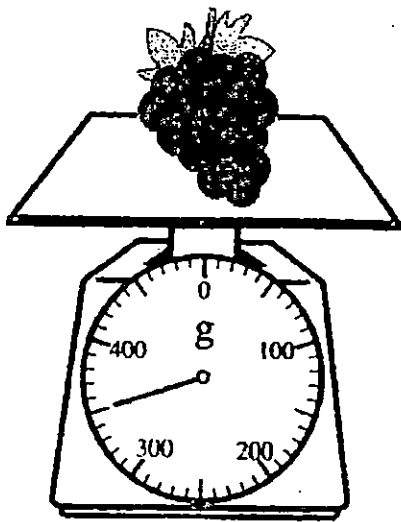

What is the total mass of the grapes and bananas?

- (1) 120 g
- (2) 230 g
- (3) 580 g
- (4) 820 g

16. Mary has only the following 5 coins in her purse.



She takes out 3 coins from her purse and puts them into a donation tin. Which of the following could be her total donation?

- (1) 30¢
- (2) 70¢
- (3) 90¢
- (4) \$1

17. Mrs Koh bought an equal number of muffins and donuts at the prices shown below.

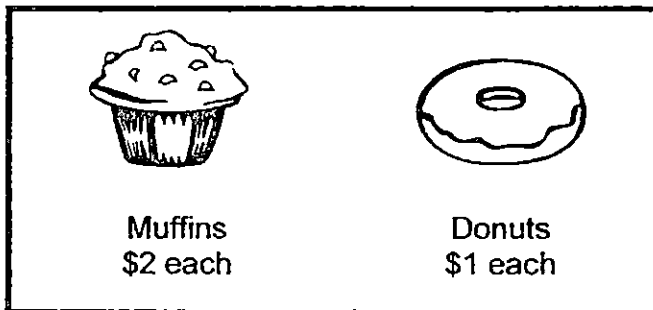

She spent \$18 altogether. How many muffins did she buy?

- (1) 6
- (2) 9
- (3) 12
- (4) 18

End of Booklet A  
Go on to Booklet B



**MARIS STELLA HIGH SCHOOL (PRIMARY)**  
**SEMESTRAL ASSESSMENT 1**  
**Primary 3 MATHEMATICS**  
**11 MAY 2015**  
**BOOKLET B**

23 questions

50 marks

Total time for Booklets A and B: 1 h 45 min

**NAME :** \_\_\_\_\_ (     )

**CLASS :** PRIMARY 3 \_\_\_\_\_

**DO NOT OPEN THIS BOOKLET UNTIL YOU ARE TOLD TO DO SO.**

**FOLLOW ALL INSTRUCTIONS CAREFULLY.**

**ANSWER ALL QUESTIONS.**

**MARKS OBTAINED :**

**BOOKLET A:** \_\_\_\_\_ / 30

**BOOKLET B:** \_\_\_\_\_ / 50

**TOTAL :** \_\_\_\_\_ / 80

**Parent's Signature:** \_\_\_\_\_



**SECTION B (32 marks)**

Questions 18 to 21 carry 1 mark each. Questions 22 to 35 carry 2 marks each. Show your working clearly in the spaces below each question and write your answers in the spaces provided. For questions which require units, give your answers in the units stated.

---

18. How many hundreds are there in 2500?

Answer: \_\_\_\_\_

---

19. What is the quotient of  $804 \div 4$ ?

Answer: \_\_\_\_\_

---

20. Find the difference between 4348 and 2579.

Answer: \_\_\_\_\_

---

21. Use all the digits below to form the smallest 4-digit odd number.

5

3

2

6

Answer: \_\_\_\_\_

---

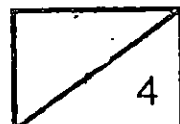

22. A shopkeeper had 3276 stickers.  
He sold 2880 stickers and gave 160 stickers to his neighbours.  
How many stickers had he left?

Answer: \_\_\_\_\_

---

23. Brendan had 257 sweets.  
He packed them into packets of 6.  
How many sweets were left unpacked?

Answer: \_\_\_\_\_

---

24. Caleb leaves his house for school at 6.45 a.m. every morning.  
He takes half an hour to reach school.  
At what time does he reach school ?

Answer: \_\_\_\_\_ a.m.

---

25. What is the missing number in the pattern?

1380, 1130, \_\_\_\_\_, 630, 380

Answer: \_\_\_\_\_

---

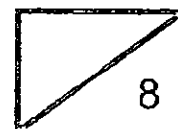

26. The diagrams below show the mass of a basket of durians, a basket of mangoes and a basket of apples.

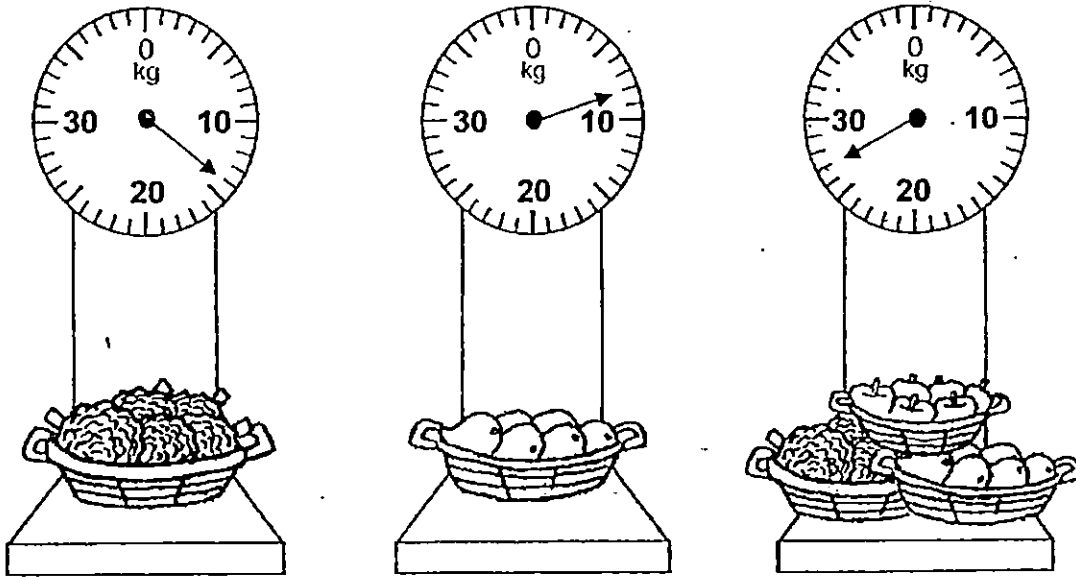

What is the mass of the basket of apples?

Answer: \_\_\_\_\_ kg

27. Train A carries 320 passengers.  
It carries 80 passengers more than Train B.  
What is the total number of passengers in both trains?

Answer: \_\_\_\_\_

28. 118 adults are going on a trip.  
Each car can take only 5 adults.  
All of them are to leave at the same time.  
What is the least number of cars needed for the trip?

Answer: \_\_\_\_\_

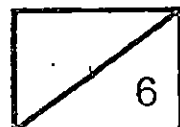

29. A 2-digit number lies between 40 and 50.  
When it is divided by 4, it gives a remainder of 3.  
When it is divided by 6, it gives a remainder of 1.  
What is the number?

Answer: \_\_\_\_\_

---

30. Pencils are sold at 3 for \$2.  
Keane has \$8.  
How many pencils can he buy?

Answer: \_\_\_\_\_

---

31. Divide the figure below into 8 equal parts.  
Then shade  $\frac{3}{8}$  of the figure.

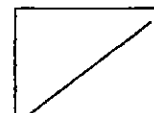
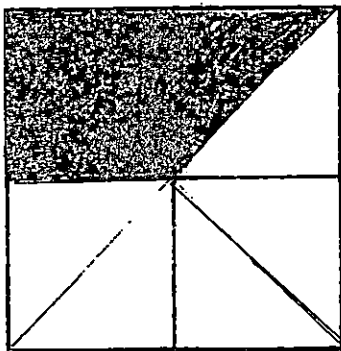

32. Study the number pattern. What is the missing number?

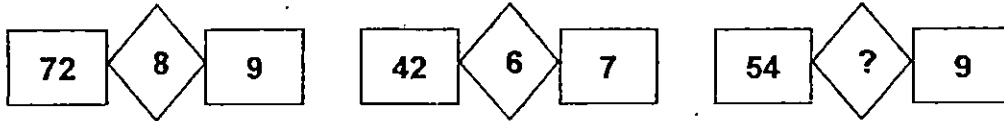

Answer: \_\_\_\_\_

---

33. Reuben thought of a number.  
He added 80 to it and then he subtracted 45 from the answer.  
The final answer is 425.  
What number did Reuben first think of?

Answer: \_\_\_\_\_

---

34. There were 12 kg of flour in Container A and some flour in Container B at first.

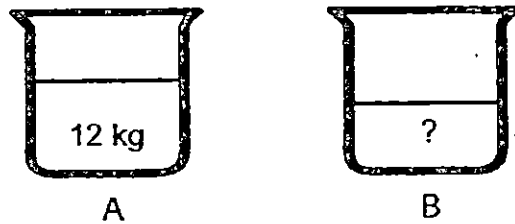

Melinda poured 3 kg of flour from Container A into Container B.  
After that, both the containers had an equal amount of flour in them.  
How much flour was in Container B at first?

Answer: \_\_\_\_\_ kg

---

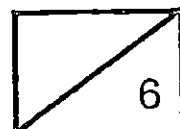

35. There are 450 oranges in 3 crates.  
Crate B contains twice as many oranges as Crate A.  
Crate C contains the same number of oranges as Crate B.  
How many oranges are there in Crate B?

Answer: \_\_\_\_\_

---

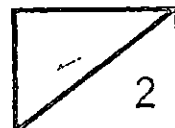

**SECTION C (18 marks)**

Questions 36 and 37 carry 3 marks each. Questions 38 to 40 carry 4 marks each. For each of the questions below, show your number statements, workings and final statements clearly. For questions which require units, give your answers in the units stated.

36. Mrs Ang bought a bag and paid \$95 for it.  
She also bought a pair of shoes.  
The pair of shoes cost 3 times as much as the bag.  
How much did she spend altogether?

Working Column

Answer: \_\_\_\_\_

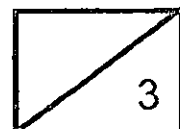

37. Kevin has 4 times as many marbles as Isaac.  
He has 126 more marbles than Isaac.  
How many marbles does Kevin have ?

Working Column

Answer: \_\_\_\_\_

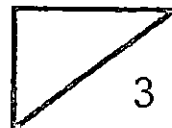



38. Mrs Anthony sold 4320 pens in 3 days.

In Day 1, she sold 1235 pens.

In Day 2, she sold 345 more pens than in Day 1.

She sold the rest of the pens in Day 3.

(a) How many pens did she sell in Day 2?

(b) How many pens did she sell in Day 3?

Working Column

Answer: (a) \_\_\_\_\_ (2)

(b) \_\_\_\_\_ (2)

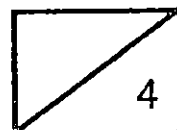

39. Jeff, Ravi and Ali received a total of 284 stamps.  
Jeff and Ravi received an equal number of stamps.  
Ali received 14 more stamps than Jeff.

- (a) How many stamps did Jeff receive?
- (b) How many stamps did Ali receive?

Working Column

Answer: (a) \_\_\_\_\_ (3)

(b) \_\_\_\_\_ (1)

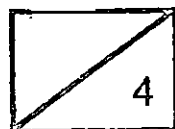

40. For every \$5 of pocket money Choon Ming saves, his father gives him \$3 to add to his savings.

If Choon Ming saves \$45 of his pocket money, how much would his total savings be?

Working Column

Answer: \_\_\_\_\_

End of Booklet B  
Please check your work carefully.

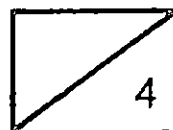



## EXAM PAPER 2015

LEVEL : PRIMARY 3

SCHOOL : MARIS STELLA HIGH SCHOOL

SUBJECT : MATHEMATICS

TERM : SA1

Q1	Q2	Q3	Q4	Q5	Q6	Q7	Q8	Q9	Q10
3	2	4	4	3	4	1	1	3	3
Q11	Q12	Q13	Q14	Q15	Q16	Q17			
3	3	1	1	3	2	2			

Q18. 25    Q19. 201    Q20. 1769    Q21. 2365

Q22. 236    Q23. 5 sweets  $\rightarrow 257 \div 6 = 45$  remainder 5.    Q24. 7.15am

Q25. 880    Q26. 5kg    Q27. 560 passengers    Q28. 24 cars    Q29. 43

Q30. 12 pencils    Q31. SEE PICTURE    Q32. 6    Q33. 390

Q34. 6kg    Q35. 180 oranges  $\rightarrow 450 \div 5 = 90, 90 \times 2 = 180$

Q36. \$380  $\rightarrow$  Bag - 1U Shoes  $\rightarrow 4U, 1U \rightarrow 95, 4U 95 \times 3 = 380$

Q37. 168 marbles  $\rightarrow$  Kelvin: 4, Isaac: 1,  $4 - 1 = 3$  (126 more),  $126 \div 3 = 42, 42 \times 4 = 168$

Q38a. 1580 pens  $\rightarrow 1235 + 345 = 1580$     Q38b. 1505  $\rightarrow 4320 - 1235 - 1580 = 1505$

Q39a. 90 stamps  $\rightarrow 284 - 14 = 270, 270 \div 30 = 90$

Q39b. 104 stamps  $\rightarrow 90 + 14 = 104$ .

Q40. \$72  $\rightarrow 45 \div 5 = 9, 9 \times 3 = 27, 45 + 27 = 72$

