



Anglo-Malinese School (Primary)

END-OF-YEAR EXAMINATION 2010
MATHEMATICS
PRIMARY TWO

Name: _____ () Class: Primary 2 _____

Date: 3 November 2010

Duration of paper: 1 h 30 min

Parent's/Guardian's signature

INSTRUCTIONS TO CANDIDATES

1. This question paper consists of 21 printed pages.
2. Do not turn this page until you are told to do so.
3. Follow all instructions carefully.
4. Answer all questions.

Section	Maximum Marks	Marks Obtained
A. Multiple-Choice Questions	36	
B. Short Answers	34	
C. Part 2 (Problem Sums)	30	
Total Marks	100	

Section A (18 Questions x 2 marks)

For each question, four options are given. One of them is the correct answer. Choose the correct answer and write 1, 2, 3 or 4 in the given brackets. All diagrams are not drawn to scale unless otherwise stated.

1. 8 hundreds and 4 ones is the same as _____.

- (1) 48
 - (2) 84
 - (3) 804
 - (4) 840
- ()

2. 600 is _____ tens less than 1 000.

- (1) 1 600
 - (2) 400
 - (3) 40
 - (4) 4
- ()

3. 4 groups of 7 = _____.

- (1) 24
 - (2) 28
 - (3) 32
 - (4) 36
- ()

4. What is the missing number?

$$12 \div 3 = 20 \div \underline{\hspace{2cm}}$$

- (1) 10
 - (2) 2
 - (3) 5
 - (4) 4
- ()

5. What is the time shown on the clock ?

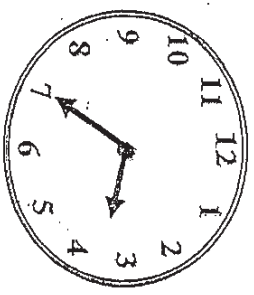

- (1) 3.35
- (2) 4.35
- (3) 7.15
- (4) 7.20

()

6. Which figure shows $\frac{1}{2}$ of the figure is shaded?

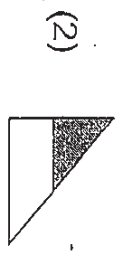

()

7. What is the value of $450 + 138 + 23$?

- (1) 151
- (2) 611
- (3) 588
- (4) 818

()

8. What is $1 - \frac{1}{4}$?

- (1) $\frac{1}{4}$
- (2) $\frac{2}{4}$
- (3) $\frac{3}{4}$
- (4) 0

()

9. Which number sentence matches this model?

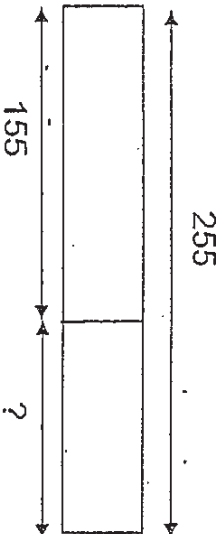

- (1) $255 + 155 = 410$
- (2) $255 - 155 = 100$
- (3) $155 - 100 = 55$
- (4) $255 + 155 + 100 = 510$

()

10. What is the length of the ribbon?

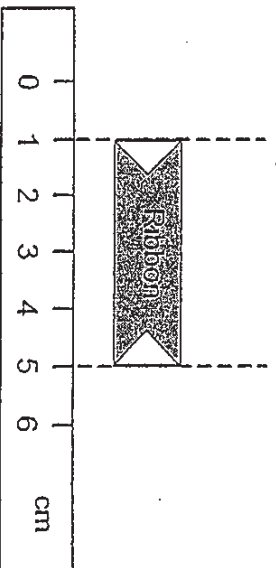

- (1) 1 cm
- (2) 5 cm
- (3) 6 cm
- (4) 4 cm

()

11. Study the pattern below.

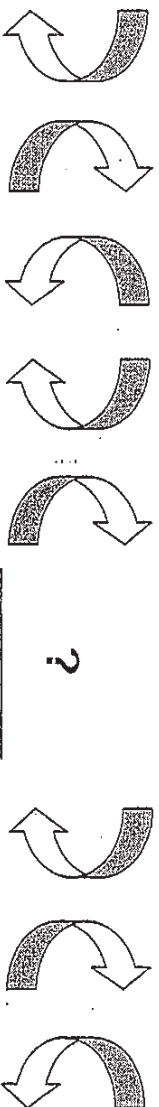

What is the missing object in the pattern?

(1)



(2)



(3)



(4)



(. . .)

12. The picture below shows 4 bottles of cooking oil. Ramesh needs to buy exactly 13 ℓ of cooking oil. Which two bottles of cooking oil can he buy?

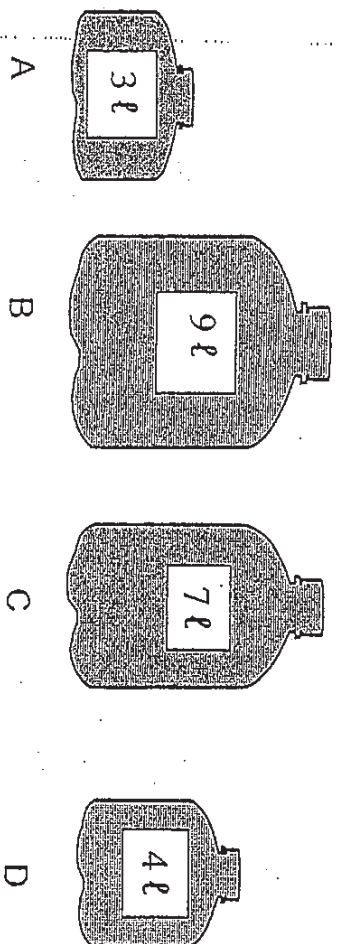

- (1) A and B
- (2) A and C
- (3) B and D
- (4) B and C

()

13.

$$\text{Smiley face} \times \text{Smiley face} = 9$$

$$\text{Padlock} + \text{Padlock} + \text{Smiley face} = 7$$

What is $\text{Padlock} \times \text{Smiley face} = ?$

- (1) 5
- (2) 2
- (3) 6
- (4) 16

()

14. What is the missing number?

$$865 - \underline{\hspace{2cm}} = 128$$

- (1) 737
- (2) 743
- (3) 747
- (4) 993

()

15. Study the number patterns below carefully.
What is the missing number in the box?

2	3
3	4
6	12

6	7
5	5
30	35

5	2
2	?
10	14

- (1) 6
- (2) 7
- (3) 8
- (4) 9

()

16. Mrs Deva wanted to buy some apples and oranges.
If 1 apple and 1 orange cost \$2, how much do 5 apples and 5 oranges cost?

- (1) \$ 5
- (2) \$ 7
- (3) \$ 10
- (4) \$ 20

()

17. Study the weighing scales carefully.
The mass of the box is _____.

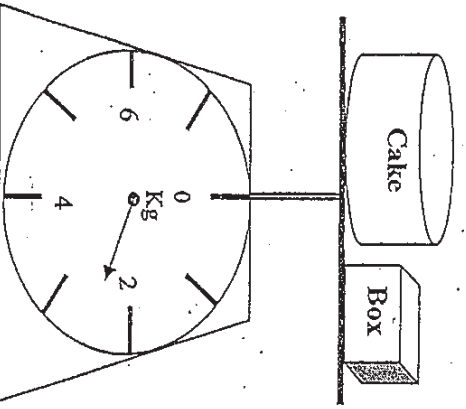
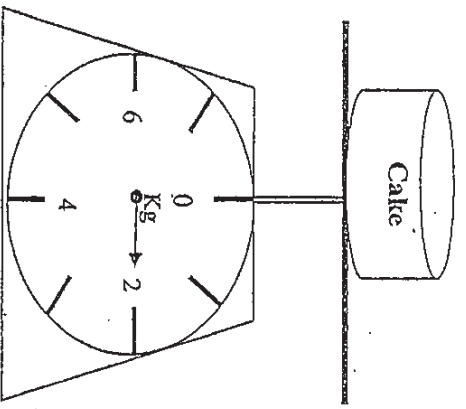

- (1) 2 kg
 - (2) more than 2 kg
 - (3) less than 1 kg
 - (4) more than 1 kg
- ()

18. Mr Soh has 4 children.
Jovan is taller than Tommy.
Benny is shorter than Tommy.
Jovan is shorter than Pauline.
Who is the tallest child?

- (1) Jovan
 - (2) Benny
 - (3) Tommy
 - (4) Pauline
- ()

Section B (17 Questions x 2 marks)

Questions 19 to 35 carry 2 marks each. Write your answers in the spaces provided. Give your answers in the units stated. All diagrams are not drawn to scale unless otherwise stated.

Mr Gan sells 4 different kinds of burger in the school canteen.

The picture graph below shows the number of burgers Mr Gan sold on a particular day.

Study it carefully and answer questions 19, 20 and 21.

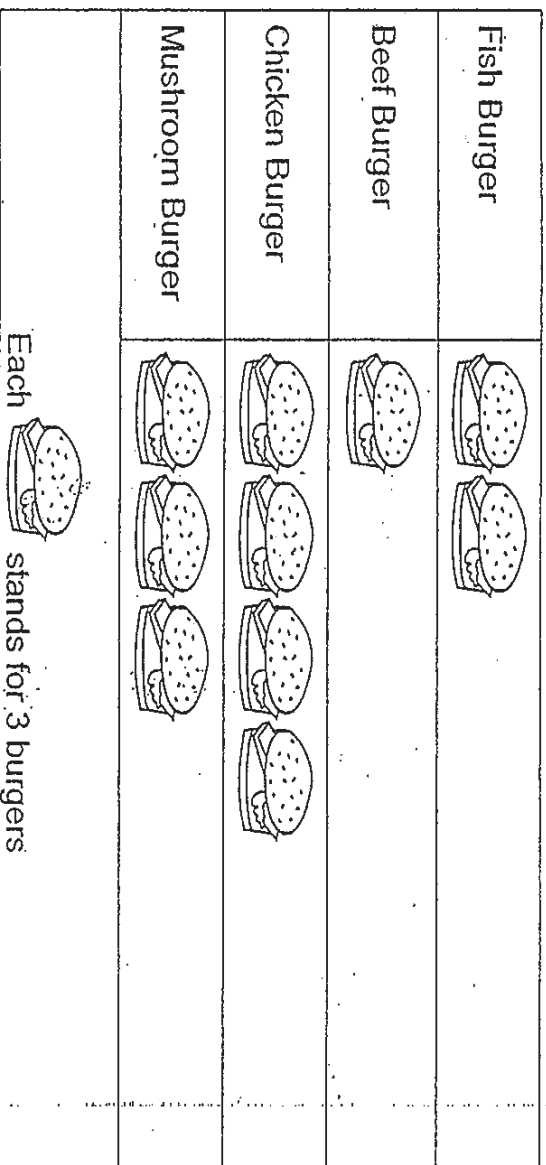

19. How many Fish Burgers did Mr Gan sell on that day?

Answer : _____

20. How many fewer Mushroom Burgers than Chicken Burgers did Mr Gan sell on that day?

Answer : _____

21. How many burgers did Mr Gan sell altogether on that day ?

Answer : _____

22. Write the number in words.

590 =

23. Study the pattern below. What comes next?

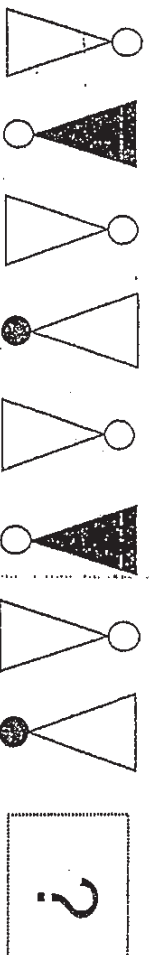

Answer : _____

24. Jon went jogging at 5.30 p.m. He reached home 1 hour later. He reached home at _____.

Answer : _____ p.m.

25. What is the missing digit in the box?

$$\begin{array}{r} 8 \quad 0 \quad 6 \\ - \quad \boxed{?} \quad 5 \quad 9 \\ \hline 2 \quad 4 \quad 7 \end{array}$$

Answer : _____

26. Mary bought a table and a chair shown below for her home. If she gave the cashier \$300, how much was her change?

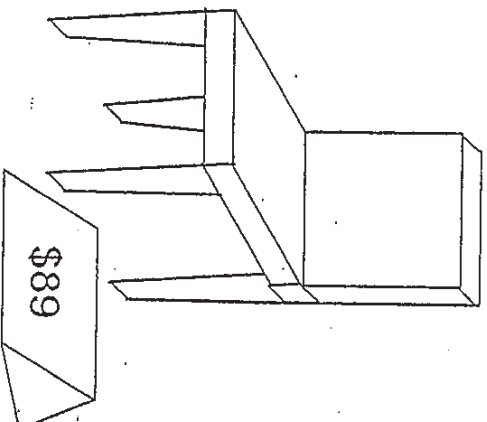
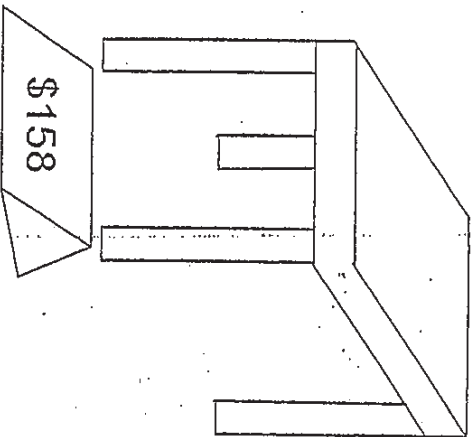

Answer : \$ _____

27. What is the most number of triangles in the figure below?

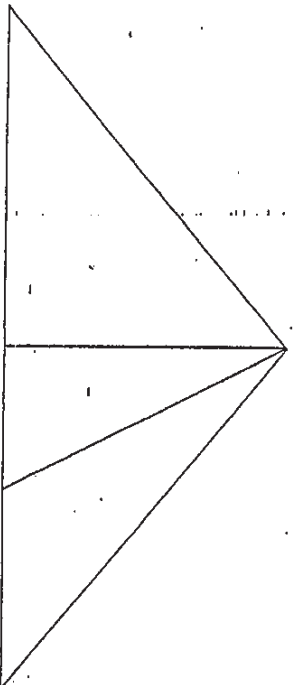

Answer : _____

28. Mr Tan, Mrs Tan and their four-year old son went for a movie. An adult ticket cost \$9 while a child's ticket cost \$5. How much did he pay altogether?

	Price of tickets
Adult	\$ 9
Child (below 12 years old)	\$ 5

Answer : \$ _____

29. Study the diagram below and fill in the blanks.

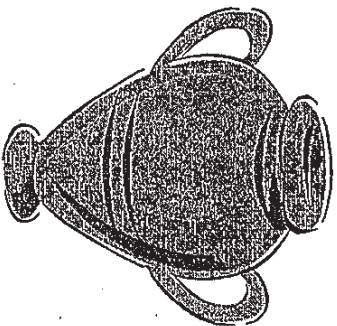

3 ℓ



1 ℓ

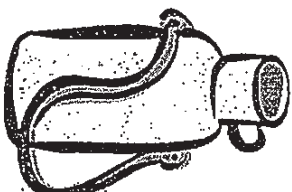

2 ℓ

The volume of water in container _____ is twice the volume of water in container _____.

30. Mrs Nuru bakes 40 cookies. She puts the cookies equally into 5 boxes. She will have _____ cookies in each box.

Answer : _____

31. In the diagram below, an empty flask can hold 3 l of water.

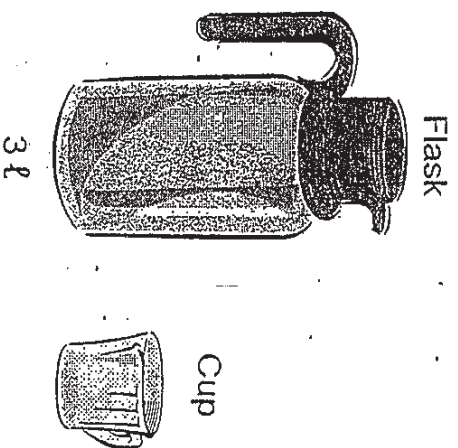

Three cups of water were needed to fill up an empty flask completely. How many cups will be needed to fill 4 full flasks of water?

Answer : _____ cups

32. Look at the following fractions.
Which is the largest fraction?

$$\frac{1}{6}, \frac{1}{9}, \frac{1}{3}$$

Answer : _____

33. Aminah has 4 different blouses and 2 different skirts. In how many ways can she wear her blouses and skirts?

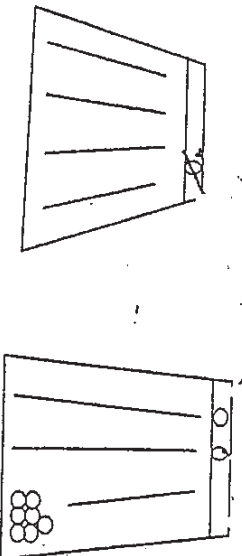
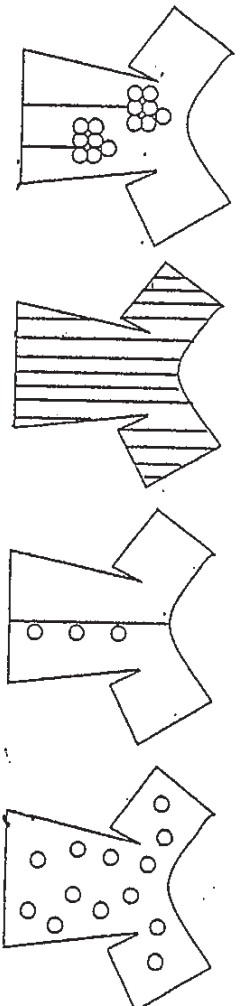

Answer : _____

34. What fraction of the figure is not shaded?

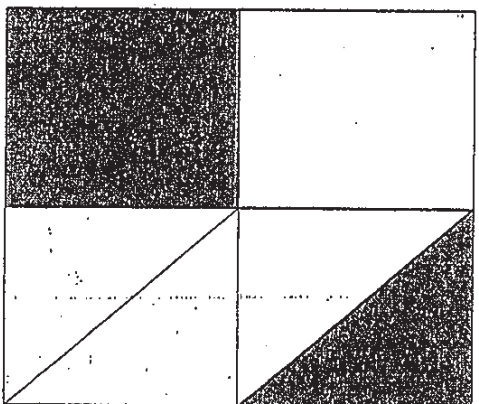

Answer : 1/4

35. I am a 3-digit number. My digits are 2, 4 and 8. I'm greater than 284 but smaller than 450. What number am I?

Answer : 428

Section C (30 marks)

For questions 36 to 44, show your working and statements clearly in the space provided for each question. The number of marks available is shown in brackets [] at the end of each question or part-question.

36. Jim has 237 erasers. He has 129 erasers more than his sister. How many erasers does his sister have? [3 marks]

Working

37. Sharon read 28 pages of her book on Monday and 67 pages on Tuesday. If the book has a total of 381 pages, how many pages were not read at the end of Tuesday? [3 marks]

Working

38. Jason bought two boxes of sweets. There were 18 sweets in each box. He unpacked all the sweets and put them equally into 9 bags. How many sweets were there in each bag? [3 marks]

Working

39. Andrew had 1 fifty-dollar note and 3 ten-dollar notes. He spent \$73 on a dress for his mother. How much money had he left? [3 marks]

Working

40. Vijay ate $\frac{1}{9}$ of a cake every day. After 5 days, what fraction of the cake was left? [3 marks]

Working

41. Joel likes to eat chicken nuggets. When he buys 5 nuggets, he will get 2 sausages. If he buys 30 nuggets, how many sausages will he get? [3 marks]
(Hint: Use a table)

Number of nuggets	5						
Number of sausages	2						

42. Jessie has 79 stamps more than Pam. Pam has 128 stamps less than Scott. Scott has 340 stamps. (Hint: Working backwards)
- a) How many stamps does Pam have? [1 mark]
- b) How many stamps do Jessie and Scott have in all? [3 marks]

Working

43. Tim and Harry have a total of 35 marbles.
Tim has 17 less marbles than Harry.

a) How many marbles does Tim have? [2 marks]

b) Tim's brother has 3 times as many marbles as him. How many marbles does his brother have? [2 marks]

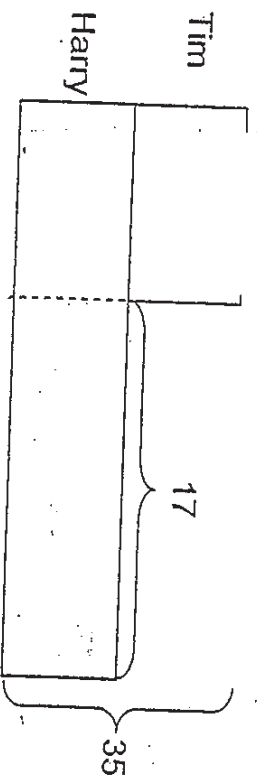

44. Michelle had only 6 coins in her purse. She used all the coins to buy 2 chicken wings.
- a) If each chicken wing cost 60¢, how much did she have in her purse at first? [1 mark]
- b) Of all the 6 coins in her purse, one of them was a 50-cent coin while the rest were 20-cent and 10-cent coins. How many 20-cent coins did she have? [3 marks]
(Hint: Guess and Check/ Draw a picture)



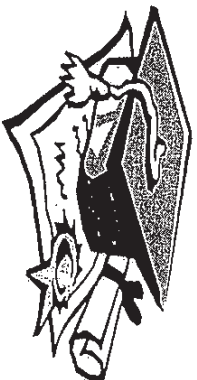

ANSWER SHEET

EXAM PAPER 2010

SCHOOL : ANGLO-CHINESE PRIMARY
SUBJECT : PRIMARY 2 MATHEMATICS

TERM : SA2

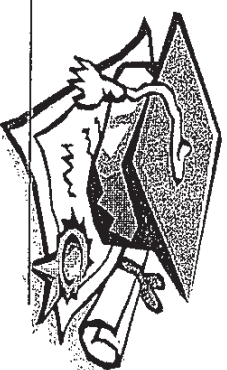

Q1	Q2	Q3	Q4	Q5	Q6	Q7	Q8	Q9	Q10	Q11	Q12	Q13	Q14	Q15	Q16	Q17
3	3	2	3	1	3	2	3	2	4	3	3	3	1	2	3	3

Q18
4

- 19) 6 20) 3 21) 30 22) five hundred and ninety 23) 
- 24) 6.30 25) 5 26) 53 27) 6 28) 23
- 29) C is twice.... B 30) 8 31) 12 32) 1/3 33) 8 4) 5/8 35) 428

36) $237 - 129 = \underline{108}$	37) $67 + 28 = 95$ $381 - 95 = \underline{286}$
38) $18 + 18 = 36$ $36 \div 9 = 4$	39) $\$10 \times 3 = \30 $\$50 + \$30 = \$80$ $\$80 - \$73 = \underline{\$7}$

40) $1/9 \times 5 = 5/9$ $1 - 5/9 = \underline{4/9}$	41)						
	No. nuggets	5	10	15	20	25	30
42a) $340 - 128 = \underline{212}$ 42b) $212 + 79 = 291$ $291 + 340 = \underline{631}$	No. sausages	2	4	6	8	10	<u>12</u>
	43a) $35 - 17 = 18$ $18 \div 2 = 9$	43b) $9 \times 3 = \underline{27}$					

44a) $\$0.60 \times 2 = \1.20
b) Michelle has 2 twenty-cent coins.

