

SINGAPORE CHINESE GIRLS' SCHOOL

SEMESTRAL ASSESSMENT 2014

PRIMARY 2

MATHEMATICS

Name: _____

Date : _____

Class: Primary 2 SY / C / G / SE / P / GR

	Marks attained	Max Mark	Parent's Signature
Section A		20	
Section B		15	
Section C		15	
Total		50	

Total Time: 1 h 15 min

INSTRUCTIONS TO CANDIDATES

DO NOT OPEN THIS BOOKLET UNTIL YOU ARE TOLD TO DO SO.

FOLLOW ALL INSTRUCTIONS CAREFULLY.

ANSWER ALL QUESTIONS.

CHECK THAT ALL MCQ ANSWERS ARE SHADED CORRECTLY IN THE OAS.

This question paper consists of 17 printed pages. (inclusive of cover page)

Section A : (20 marks)

Questions 1 – 10 carry 1 mark each. Questions 11 – 15 carry 2 marks each.

For each question, 4 options are given. One of these is the correct answer. Make your choice (1, 2, 3, 4). Shade the correct oval on the Optical Answer Sheet (OAS).

1. In the number 459, the digit '5' stands for _____.

- (1) 5
- (2) 50
- (3) 59
- (4) 500

2. $597 + 243 =$ _____

- (1) 354
- (2) 730
- (3) 740
- (4) 840

3. 3 hundreds 9 tens and 15 ones = _____.

- (1) 305
- (2) 324
- (3) 405
- (4) 540

4. Which of the following does not represent the picture below?

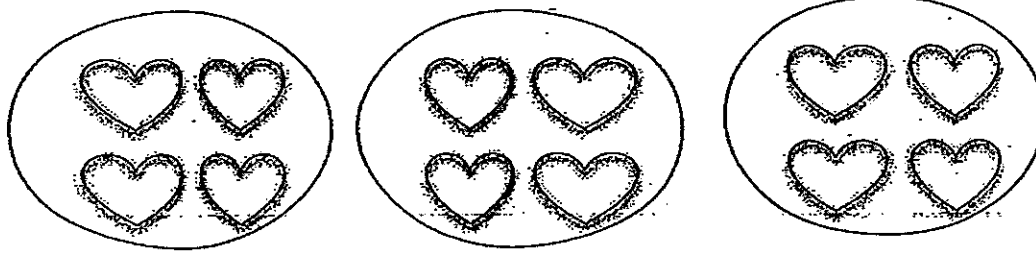

- (1) $4 + 4 + 4$
- (2) 3×4
- (3) 4 groups of 3
- (4) 3 groups of 4

5. 18 cookies were shared among 3 friends. How many cookies did each person receive?

- (1) 5
- (2) 6
- (3) 3
- (4) 15

6. How many curved lines are there in the figure below?

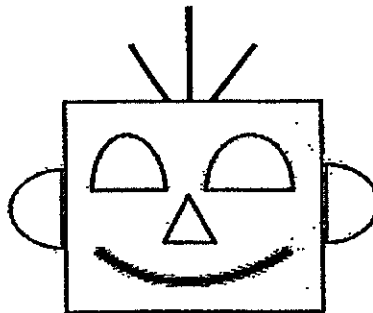

- (1) 19
- (2) 9
- (3) 5
- (4) 4

7. How much more water is there in Pail A than Pail B?

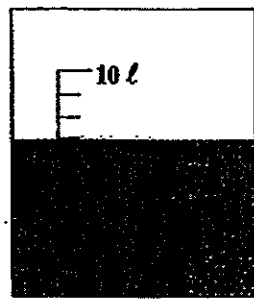

Pail A

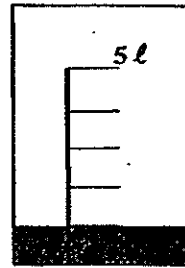

Pail B

- (1) 5 l
- (2) 6 l
- (3) 8 l
- (4) 15 l

8. How many semicircles are there in the figure below?

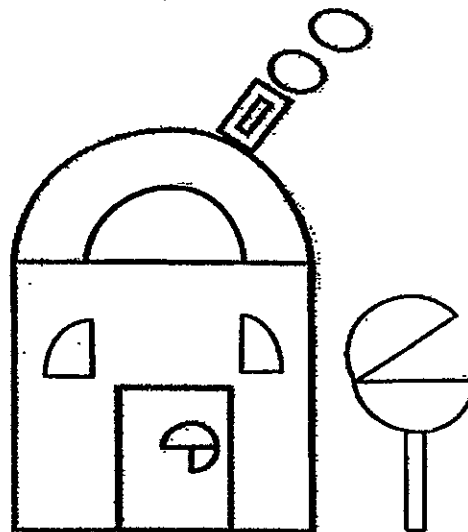

- (1) 10
- (2) 8
- (3) 5
- (4) 4

9. Sharifah spent 30 minutes doing her homework. She completed her work at 8.00 p.m. What time did she start doing her homework?

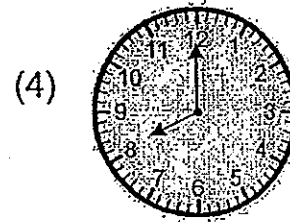
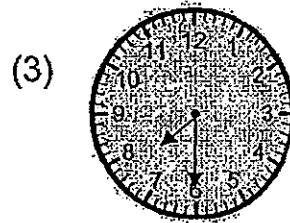
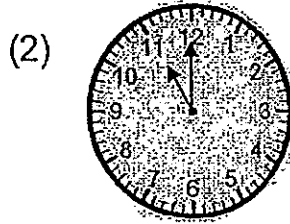
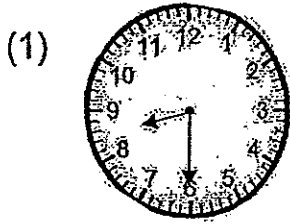

10. How many flat surfaces are there altogether?

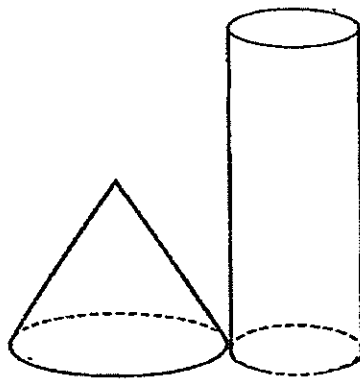

- (1) 5
(2) 2
(3) 3
(4) 4

11. What fraction of the figure is shaded?

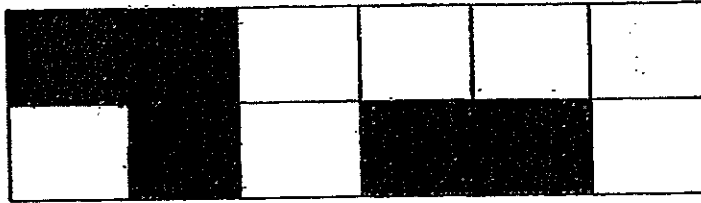

(1) $\frac{4}{12}$

(2) $\frac{4}{11}$

(3) $\frac{5}{12}$

(4) $\frac{7}{12}$

12. Stephanie has 124 stickers. She has 89 stickers less than Christy. How many stickers does Christy have?

(1) 35

(2) 45

(3) 203

(4) 213

Section B : (15 marks)

Questions 16 – 20 carry 1 mark each. Questions 21 – 25 carry 2 marks each. Write your answers in the blanks provided. All workings must be shown clearly.

16. Write the following in words.

794	
-----	--

17. Write a division sentence for the following.

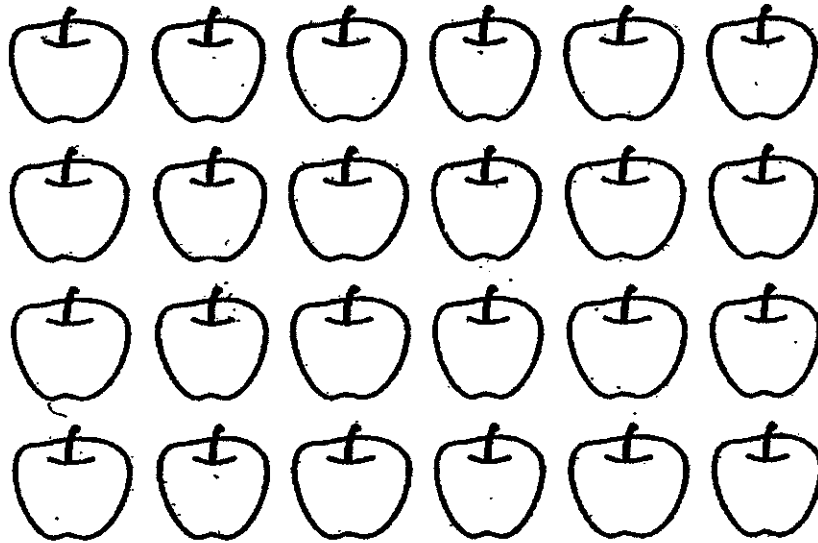

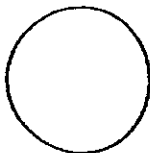
			=	
--	---	--	---	--

18. Complete the number pattern below.

135	145	165	195		285	345
-----	-----	-----	-----	--	-----	-----

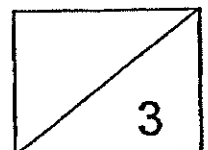

19. Arrange the fractions from the greatest to the smallest.

$$\frac{1}{3}, \frac{1}{9}, \frac{1}{2}, \frac{1}{10}$$

_____ , _____ , _____ , _____
greatest

20. Melissa left the house 5 minutes before 7.00 a.m. Using a pencil and ruler, draw the hour and minute hands to show the time she left the house.

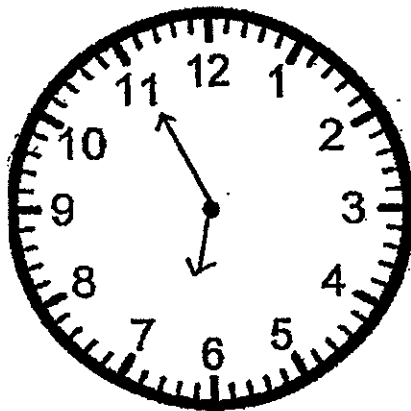

21. Tammy baked 80 cookies. She packed them into packets of 10. She gave her neighbour 2 packets. How many packets of cookies will she have left?

Ans: _____ packets

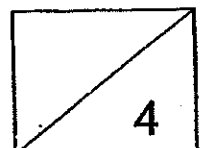

22. Below is the amount of money Jamie has in her wallet. Answer questions 22 (a) and (b).

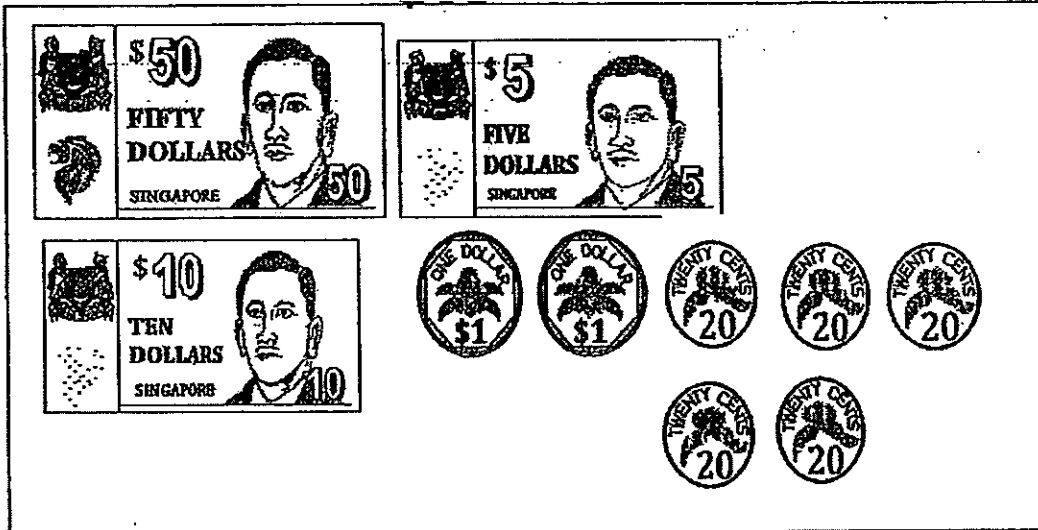

(a) How much does Jamie have in her wallet?

Ans: \$ _____

(b) Jamie wants to buy a dress that costs \$105. How much more does she need to buy the dress?

Ans: \$ _____

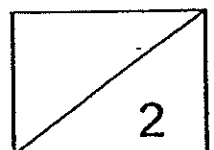

23. Refer to the picture below and answer Question 23 (a) and (b).

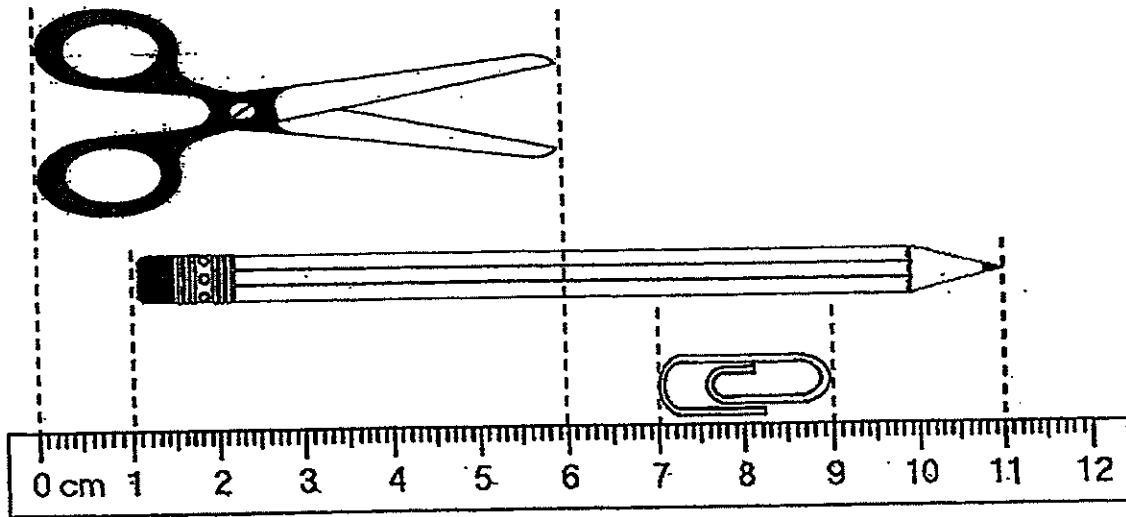

(a) The pencil is _____ cm longer than the paper clip.

Ans: _____ cm

(b) The total length of the scissors and pencil is _____ cm

Ans: _____ cm

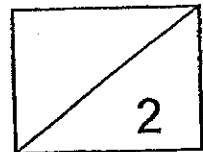

24. Refer to the graph below and answer Question 24 (a) and (b).

The graph below shows the different types of sports some pupils like.

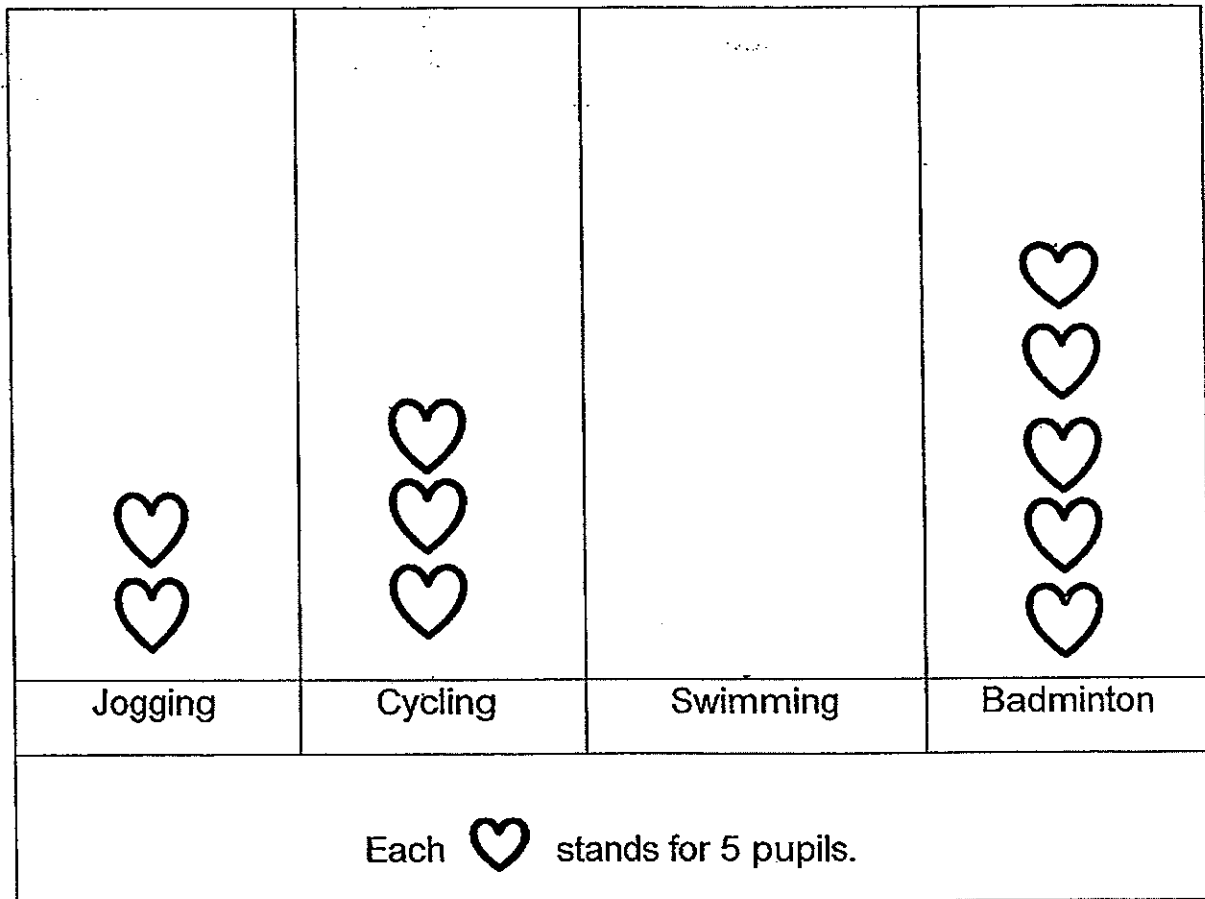

(a) How many more pupils like badminton than jogging?

Ans: _____ pupils

(b) There are 20 pupils who like swimming. Draw the correct number of  on the graph to show the number of pupils who like swimming.

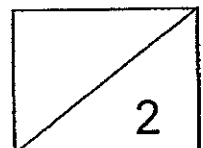

25. There were a total of 10 cars stuck in a traffic jam. Sam's car was third from the front. There were 4 cars between David's car and Sam's car. How many cars were behind David's car?

Ans: _____ cars

END OF SECTION B

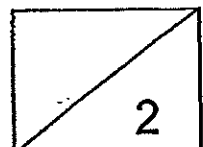

Section C : (5 x 3 = 15 marks)

Questions 26 - 30 carry 3 marks each. All workings must be clearly shown.

26. Stephanie, Devi and Jayden ordered a pizza. Stephanie ate $\frac{1}{9}$ of the pizza and Devi ate $\frac{4}{9}$ of the pizza. Jayden ate the rest of the pizza. What fraction of the pizza did Jayden eat?

Jayden ate _____ of the pizza.

27. Mr Lee sold 255 apples in the morning. He sold 168 fewer apples in the afternoon than in the morning. How many apples did he sell altogether?

Mr Lee sold _____ apples altogether.

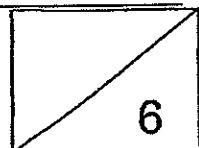

28. A large pail can hold 30ℓ of water. It can hold 25ℓ more water than a bottle. How many bottles will be needed to fill up a large pail?

6 bottles are needed to fill up a large pail.

29. At a sale, notebooks were sold at 3 for \$4. Mr Tan bought 6 such notebooks. He gave the cashier a fifty-dollar note. How much change did he receive?

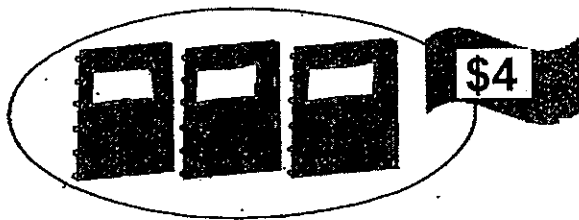

He received \$ _____

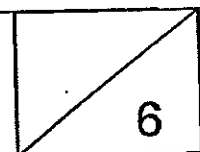

30. Stephanie read 2 pages of her book everyday. She took 10 days to finish reading the entire book. How many pages should she read each day so that she can finish reading the entire book in 4 days?

She should read _____ pages each day.

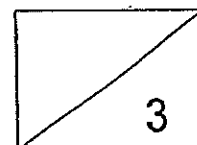

END OF PAPER
Please check your work.

Year: 2014

Level: Primary 2

School: SCGS

Semester: SA2

Q1	Q2	Q3	Q4	Q5	Q6	Q7	Q8	Q9	Q10
2	4	3	3	2	3	2	3	3	3
Q11	Q12	Q13	Q14	Q15	Q16	Q17	Q18	Q19	Q20
3	4								

Q16) Seven hundred and ninety-four

Q17) $24 \div 4 = 6$

Q18) 235

Q19) $\frac{1}{2}$, $\frac{1}{3}$, $\frac{1}{9}$, $\frac{1}{10}$

Q20)

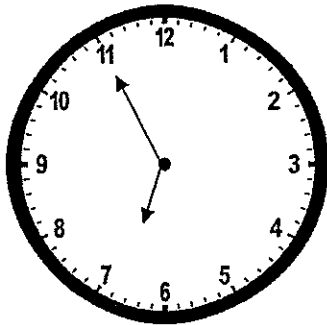

Q21) 6

Q22) a) \$68 b) \$37

Q23) a) 8 b) 16

Q24) a) 15 b) 4 hearts

Q25) 2

Q26) $\frac{4}{9} + \frac{1}{9} = \frac{5}{9}$

$$\frac{9}{9} - \frac{5}{9} = \frac{4}{9}$$

Jayden ate $\frac{4}{9}$ of the pizza.

Q27) $255 - 168 = 87$

$$255 + 87 = 342$$

Mr Lee sold 342 apples altogether.

Q28) $30-25=5$

$$30 \div 5 = 6$$

6 bottles are needed to fill up a large pail.

Q29) $4+4=8$

$$50-8=42$$

He received \$42.

Q30) Number of pages $\rightarrow 2 \times 10 = 20$

$$20 \div 4 = 5$$

She should read 5 pages each day.