



PEI HWA PRESBYTERIAN PRIMARY SCHOOL  
PRELIMINARY EXAMINATION

PRIMARY 6  
MATHEMATICS PAPER 1  
(BOOKLET A)

25 AUGUST 2015

Name: \_\_\_\_\_

Form Class / Register No. : 6R \_\_\_\_\_ / \_\_\_\_\_

Banded Class / Register No. : 6M \_\_\_\_\_ / \_\_\_\_\_

Total time for Booklets A and B: 50min

**INSTRUCTIONS TO CANDIDATES**

1. Write your Name, Class and Register No. in the spaces provided above.
2. DO NOT turn over this page until you are told to do so.
3. Follow all instructions carefully.
4. Answer all questions.
5. Shade your answers on the Optical Answer Sheet (OAS) provided.
6. The use of calculator is **NOT ALLOWED**.

This booklet consists of 6 printed pages, excluding the cover page.

**Paper 1 (Booklet A)**

Questions 1 to 10 carry 1 mark each. Questions 11 to 15 carry 2 marks each. For each question, four options are given. One of them is the correct answer. Make your choice ( 1, 2, 3 or 4 ). Shade the oval ( 1, 2, 3 or 4 ) on the Optical Answer Sheet. You are not allowed to use a calculator. ( 20 marks )

---

1 What is the value of seven million, seven hundred and seven thousand, and seventy-seven?

(1) 7 007 777

(2) 7 700 777

(3) 7 707 077

(4) 7 770 077

( )

2 Divide  $\frac{1}{2}$  by  $\frac{1}{8}$ .

(1) 16

(2)  $\frac{1}{16}$

(3)  $\frac{1}{4}$

(4) 4

( )

3 What is the value of  $10 \div 5000$ ?

(1) 500

(2) 50

(3) 0.02

(4) 0.002

( )

4 Which of the following is the same as 2080 g ?

(1) 2 kg 8 g

(2) 2 kg 80 g

(3) 20 kg 8 g

(4) 20 kg 80 g

( )

5 Hannah uses part of a ruler to measure the length of a pencil.

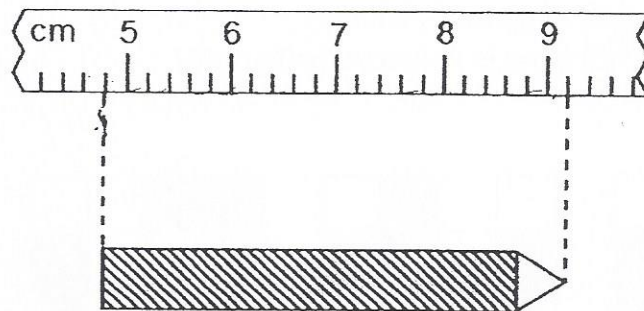

What is the length of the pencil as shown in the figure above?

(1) 4.2 cm

(2) 4.4 cm

(3) 9.1 cm

(4) 9.2 cm

( )

- 6 The figure below shows the net of a cube.  
Which 2 faces of the cube are opposite each other?

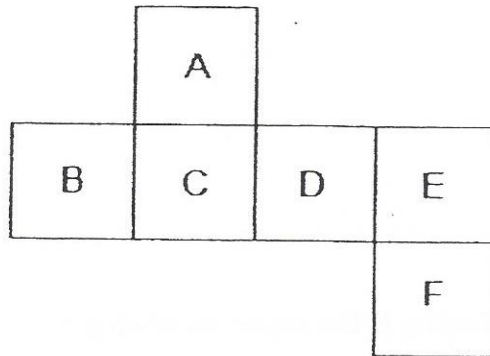

- (1) A and E  
(2) B and E  
(3) A and F  
(4) B and F

( )

- 7 Each figure below is made up of 16 squares.  
8 squares in each figure are shaded.  
Which of the following is a symmetric figure?

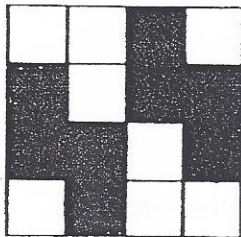

(1)

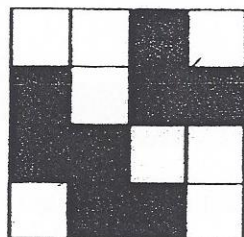

(2)

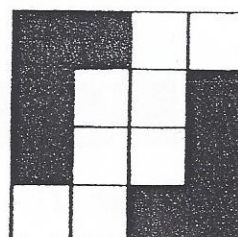

(3)

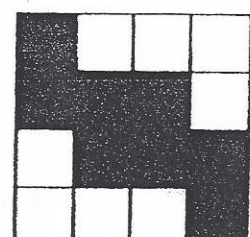

(4)

( )

8 The total mass of a chicken and a duck is 8 kg. The chicken weighs 3 kg. What is the ratio of the mass of the chicken to that of the mass of the duck?

(1) 8 : 3

(2) 5 : 3

(3) 3 : 8

(4) 3 : 5

( )

9 Express 12.3% as a decimal.

(1) 12 300

(2) 12.3

(3) 1.23

(4) 0.123

( )

10 Simplify  $15x + 8g - 10 - 3g$

(1)  $5 + 5g$

(2)  $5 + 11g$

(3)  $25 - 5g$

(4)  $25 + 11g$

( )

11 Alfred had twice as many paper clips as Betty. Betty had 20 fewer paper clips than Charlene. If the three children had 68 paper clips altogether, how many paper clips did Betty have?

(1) 12

(2) 22

(3) 24

(4) 32

( )

- 12 Mrs Lim and Mrs Wong spent a total of \$1200 during the Great Singapore Sale.  $\frac{3}{5}$  of what Mrs Lim spent was equal to  $\frac{1}{5}$  of what Mrs Wong spent. Who spent more and how much more did she spend?
- (1) Mrs Lim, \$180  
(2) Mrs Lim, \$300  
(3) Mrs Wong, \$600  
(4) Mrs Wong, \$900
- ( )

- 13 Cubes of sides 1-cm are stacked in the corner of a box as shown below.

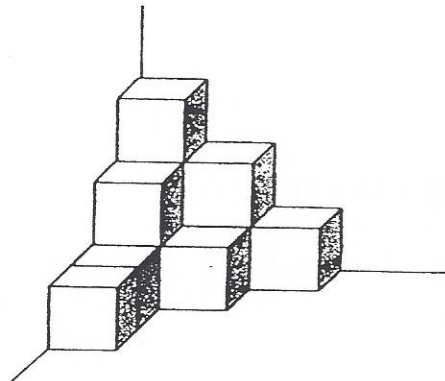

How many more cubes are needed to make it into a cube of sides 4-cm?

- (1) 7  
(2) 11  
(3) 53  
(4) 57
- ( )



- 14 In the figure, ABCD is a rectangle.  $\angle AFE$  is  $43^\circ$ .  
Find  $\angle FCD$ .

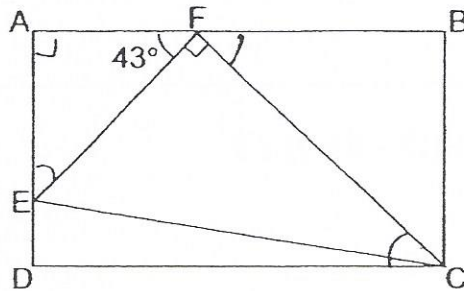

- (1)  $47^\circ$   
 (2)  $57^\circ$   
 (3)  $133^\circ$   
 (4)  $137^\circ$

( )

- 15 Mrs Tan spent \$360 on some clothing. The pie chart shows how she spent her money. How much money did she spend on skirts and shirts?

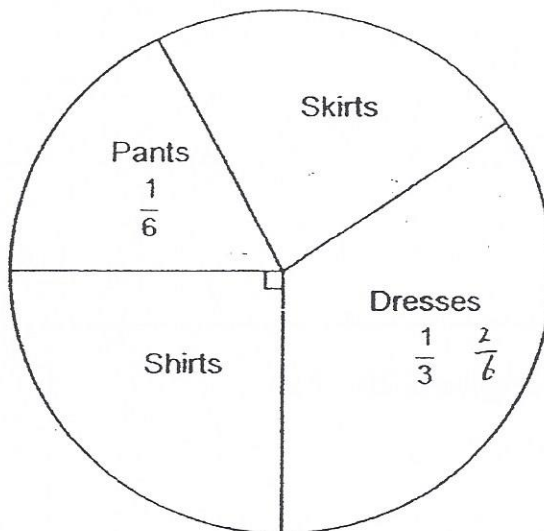

- (1) \$60  
 (2) \$90  
 (3) \$120  
 (4) \$180

)

– End of Booklet A –

Questions 16 to 25 carry 1 mark each. Write your answers in the spaces provided. For questions which require units, give your answers in the units stated. (10 marks)

Do not write in this space.

16 Find the value of  $77 + (12 - 5 \times 2) \times 9$ .

Ans: \_\_\_\_\_

17 Express  $3\frac{2}{9}$  as an improper fraction in the simplest form.

Ans: \_\_\_\_\_

18 Find the value of  $20 - 7.07$ .

Ans: \_\_\_\_\_



- 19 The volume of the cuboid shown below is  $216 \text{ cm}^3$ . Find its length.

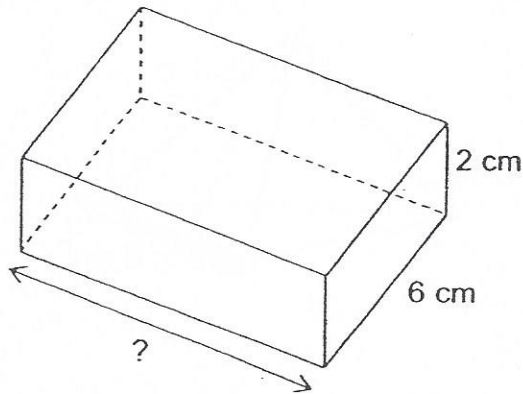

Ans: \_\_\_\_\_ cm

Do not write  
in this  
space.

- 20 Farhan reached Malacca at 04 25 after travelling for 7.5 hours.  
What time did he start travelling?  
Express your answer in 24-hour clock.

Ans: \_\_\_\_\_

- 21 Muthu is standing in the centre of 9 big tiles facing B.  
Which letter will he face when he turns  $225^\circ$  anti-clockwise?

A	B	C
D		E
F	G	H

Ans: \_\_\_\_\_

- 22 The figure below shows <sup>the net of</sup> the net of a pyramid made up of 4 equilateral triangles, each of side 6 cm. Find the sum of all the edges of the pyramid.

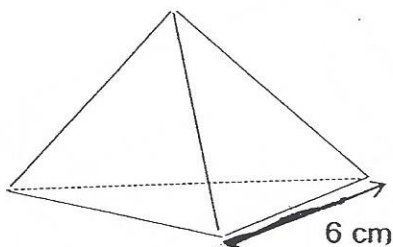
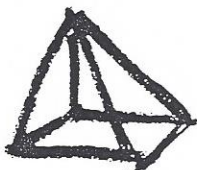

Ans: \_\_\_\_\_ cm

Do not write in this space.

- 23 Express  $\frac{75}{500}$  as a percentage.

Ans: \_\_\_\_\_ %

- 24 The average speed taken to travel from A to C was 92 km/h. Find the time taken to travel from A to C.

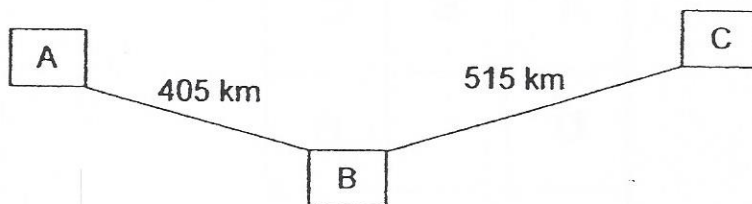

Ans: \_\_\_\_\_ h

25 The graph below shows the monthly household income of some families in a housing estate.

Do not write in this space.

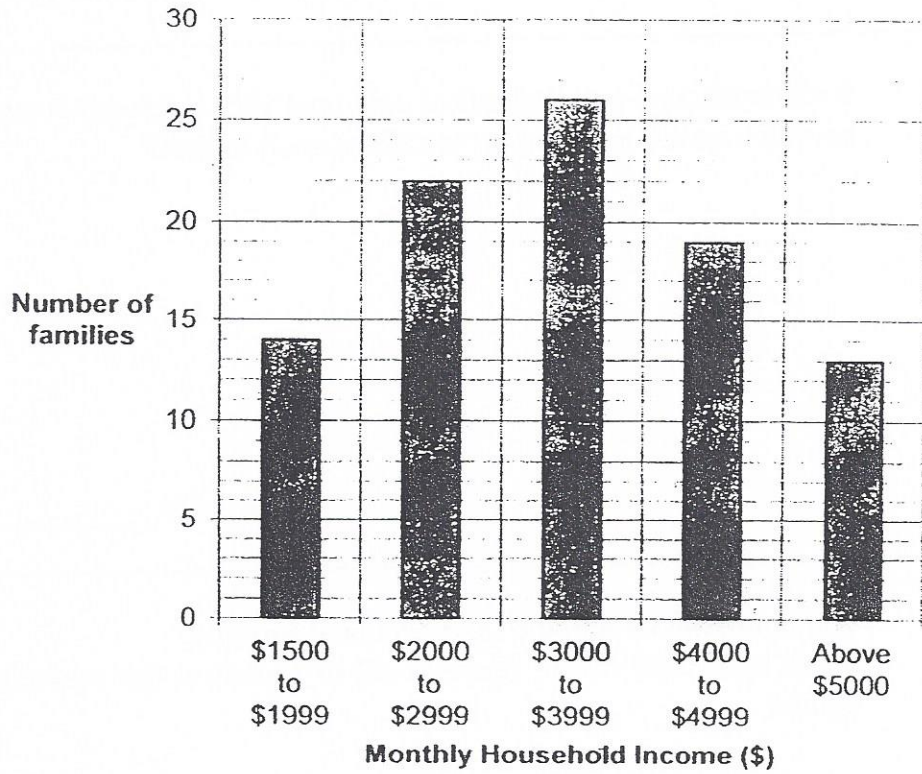

How many families have a monthly household income of more than or equal to \$4000 per month?

Ans: \_\_\_\_\_



Questions 26 to 30 carry 2 marks each. Show your working clearly and write your answers in the spaces provided. For questions which require units, give your answers in the units stated. (10 marks)

Do not write in this space.

- 26 8 identical cups and 2 identical pots cost \$80. Each pot costs six times as much as a cup. What is the cost of each teapot?

Ans: \$ \_\_\_\_\_

- 27 The figure below is made up of identical squares. If the total area of the figure is  $96 \text{ m}^2$ , what is the perimeter of the figure?

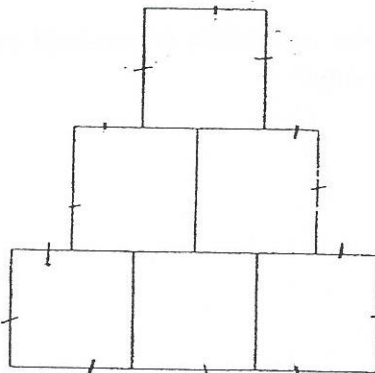

Ans: \_\_\_\_\_ m

28 A unit shape is drawn below.

Do not write  
in this  
space.

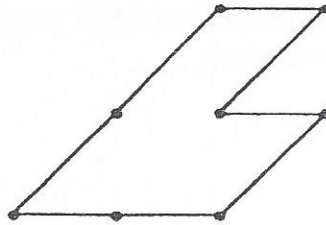

The figure below is formed by joining some unit shapes to form a tessellation. Draw lines in the figure below to show all the unit shapes that formed the tessellation.

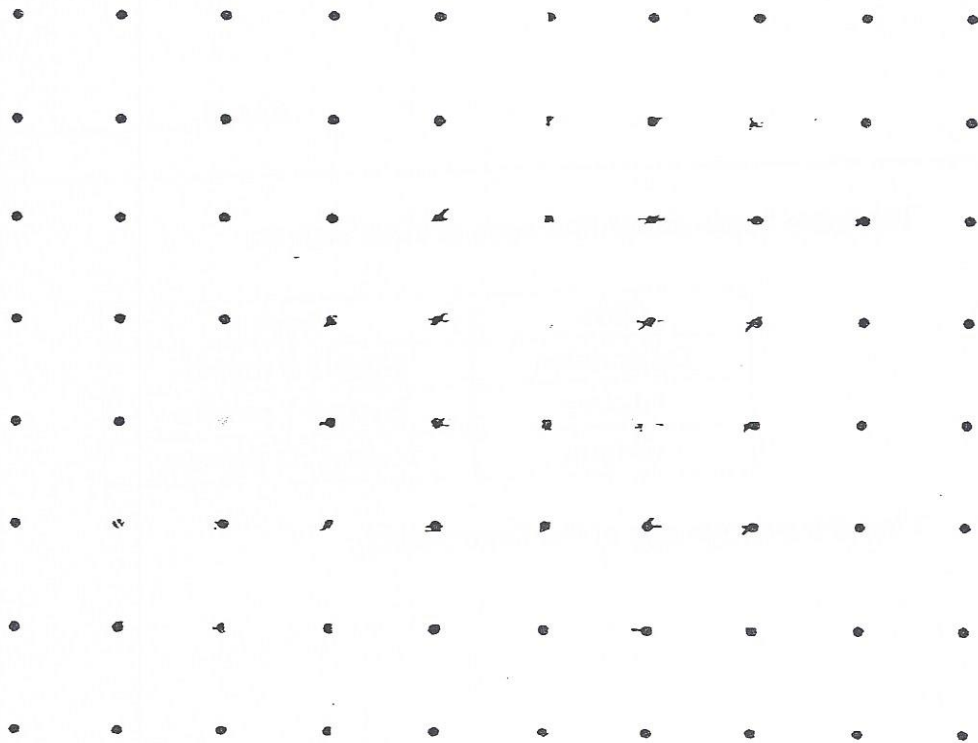

- 29 Alvin had 20% more money than Simon. Theodore had 40% more money than Alvin. If Theodore had \$840, how much did the person with the least amount of money have?

Do not write  
in this  
space.

Ans: \$ \_\_\_\_\_

- 30 The table below shows the ages of three sisters.

Girls	Ages
Gwendolyn	8 years 9 months
Glynnis	7 years 7 months
Glenda	5 years 11 months

Find the average age of the three sisters.

Ans: \_\_\_\_\_ years \_\_\_\_\_ months

END OF PAPER 1





PEI HWA PRESBYTERIAN PRIMARY SCHOOL  
PRELIMINARY EXAMINATION

PRIMARY 6  
MATHEMATICS PAPER 1  
(BOOKLET B)

25 AUGUST 2015

Name : \_\_\_\_\_

Parent's signature

Form Class / Register No. : 6R \_\_\_\_\_ / \_\_\_\_\_

Banded Class / Register No. : 6M \_\_\_\_\_ / \_\_\_\_\_

Total time for Booklets A and B: 50min

**INSTRUCTIONS TO CANDIDATES**

1. Write your Name, Class and Register No. in the spaces provided above.
2. DO NOT turn over this page until you are told to do so.
3. Follow all instructions carefully.
4. Answer all questions.
5. Write all your answers in this booklet.
6. The use of calculator is **NOT ALLOWED**.

Marks (Booklet A) :	20
Marks (Booklet B) :	20
Total Marks (Booklets A and B) :	40

This booklet consists of 7 printed pages, excluding the cover page.

Questions 1 to 5 carry 2 marks each. Show your working clearly and write your answers in the spaces provided. For questions which require units, give your answer in the units stated. (10 marks)

Do not write in this space

- 1 A tailor had 8 m of cloth. He used  $3\frac{2}{5}$  m of the cloth to make the first pair of pants and  $\frac{3}{4}$  of the remainder to make a second pair of pants. How much cloth did the tailor use to make the second pair of pants?

Ans: \_\_\_\_\_ m

- 2 The figure below shows the net of a cuboid made of 4 identical rectangles and 2 identical squares. Find the volume of the cuboid.

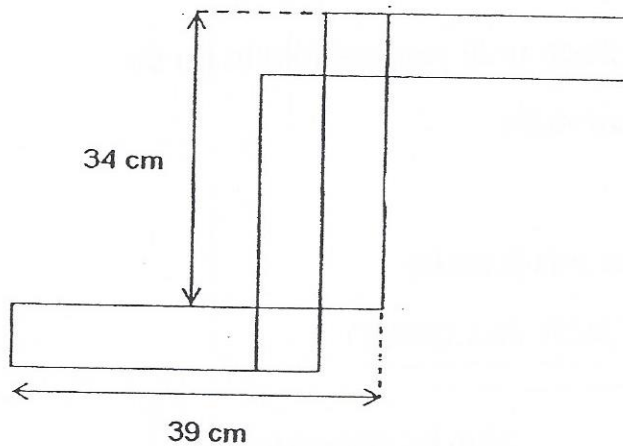

Ans: \_\_\_\_\_ cm<sup>3</sup>

- 3 The ratio of the number of Tevin's marbles to the number of Ryan's marbles was 7:3. When each of them gave 30 marbles away, the ratio of the number of Tevin's marbles to the number of Ryan's marbles was 3:4. Find the total number of marbles the boys had at first.

Do not write in this space

Ans: \_\_\_\_\_

- 4 A fence is to be built 1 m away from the sides of a square field. Each side of the square is 3 m. Find the total length of the fence needed. Give your answer in terms of  $p$  in the simplest form.

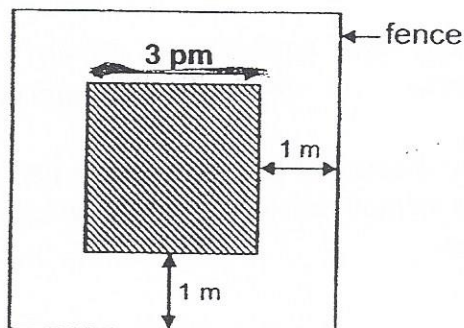

Ans: \_\_\_\_\_ m

- 5 The graph below shows the monthly average rainfall received from January to June in Singapore.

Do not write in this space

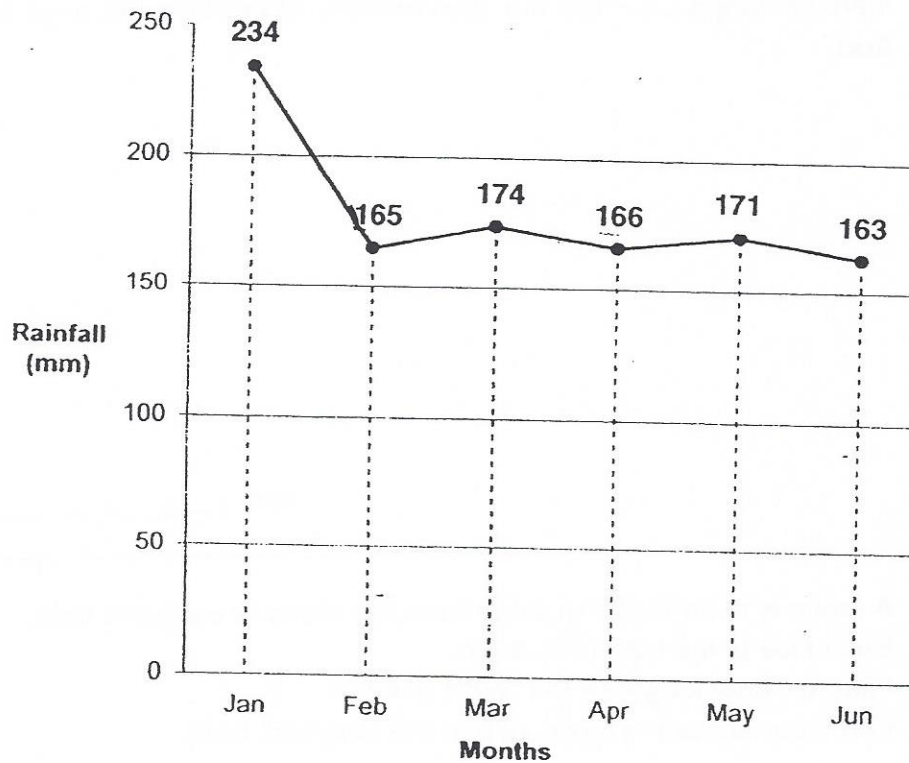

- (a) Between which two consecutive months was there the greatest increase in the average rainfall received in Singapore?
- (b) Based on your answer in (a), what is the percentage increase in the average rainfall received? Give your answer correct to 2 decimal places.

Ans: (a) \_\_\_\_\_ and \_\_\_\_\_

(b) \_\_\_\_\_ %

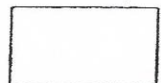



Questions 6 to 18 show your working clearly and write your answers in the spaces provided. The number of marks available is shown in brackets [ ] at the end of each question or part question. (50 marks)

Do not write in this space

- 6 A box contains 15 identical reams of paper. The total mass of the box with  $\frac{1}{5}$  of all the reams of papers is 33.6 kg lighter than the box with all the reams of paper. The mass of the empty box is  $\frac{2}{7}$  of a ream of paper. What is the mass of the empty box?

Ans: \_\_\_\_\_ [3]



- 7 In the figure below, not drawn to scale, ABCD is a rectangle of sides 36 cm by 19 cm. The area of the quadrilateral EFGH is 38 cm<sup>2</sup>. Find the area of the unshaded part.

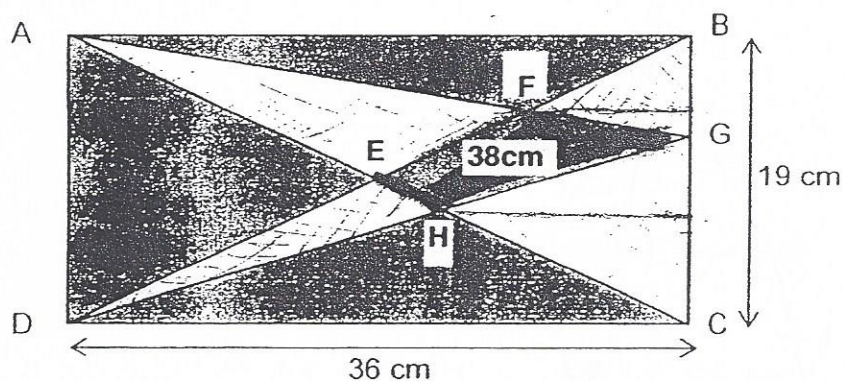

Ans: \_\_\_\_\_ [3]

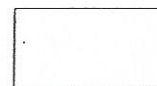

- 8 The fish tank shown below contains some water to a depth of 5 cm. Minah then added 10.5 litres of water into the tank. The tank is now  $\frac{3}{4}$  filled with water. What is the height of the tank?

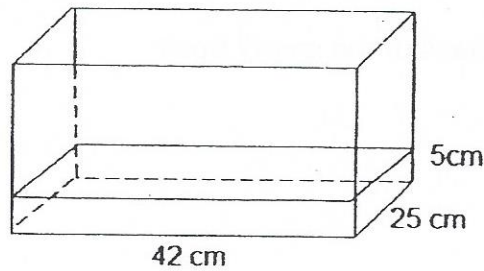

Ans: \_\_\_\_\_ [3]

Do not write in this space

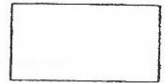

- 9 In the diagram below, not drawn to scale, ABCD is a rhombus, and DEC is an equilateral triangle. If  $\angle DAC = 43^\circ$ , find  $\angle CBE$ .

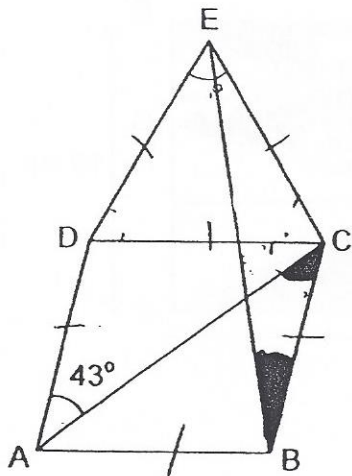

Ans: \_\_\_\_\_ [3]





10

The pie chart below shows the percentage of men, women and children who went to the stadium to watch a soccer match.

Do not write in this space

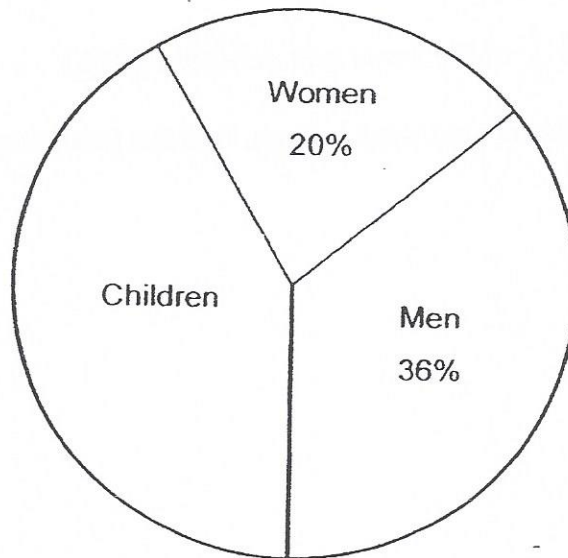

There were 2880 men at the stadium. If each woman was accompanied by her own child at the stadium and the rest of the children went on their own, how many children went to the stadium by themselves?

Ans: \_\_\_\_\_ [3]



11 Hansel sold purses and wallets. Each purse cost \$39 and each wallet cost  $\frac{2}{3}$  as much as the purse.

Hansel sold  $\frac{1}{3}$  of the items and collected \$3757.

If  $\frac{3}{7}$  of the items sold were purses, find the total number of items left.

Do not write in  
this space

Ans: \_\_\_\_\_ [4]

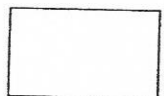

- 12 There were a total of 312 candies in Box A, B and C.  
Some candies from Box B were removed and put into Box A and C and the number of candies in each of those 2 boxes was doubled.  
Then, some candies from Box C were removed and put into Box A and B and the number of candies in each of those 2 boxes was doubled.  
At the end, the number of candies in Box B is thrice of that in Box A while the number of candies in Box A is thrice of that in Box C.  
Find the number of candies in Box B at first.

Do not write in this space

\_\_\_\_\_ : [4]

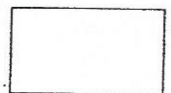

- 13 Mr Chua had a rectangular piece of cardboard. He cut out 3 semicircles, each with a diameter of 42 cm from the cardboard. The perimeter of the remaining piece of cardboard as shown below, not drawn to scale, is 462 cm.

What is the length of XY? (Take  $\pi = \frac{22}{7}$ )

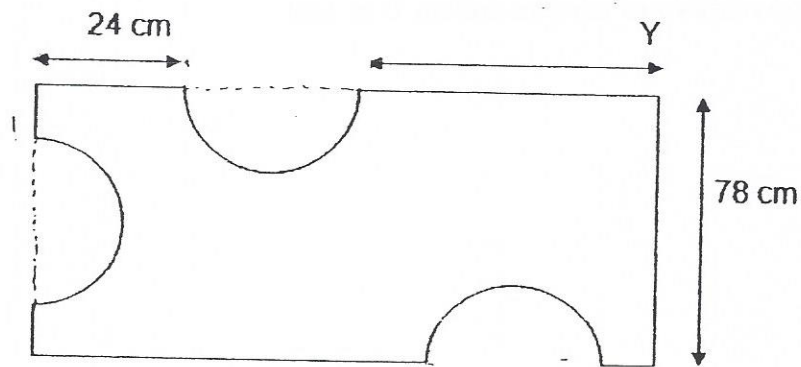

Do not write in this space

Ans: \_\_\_\_\_ [4]

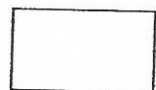

- 14 In the figure, not drawn to scale, PQRS is a parallelogram and TUR is a triangle. If  $PT = PU$ , find

- (a)  $\angle TUR$   
 (b)  $\angle URQ$

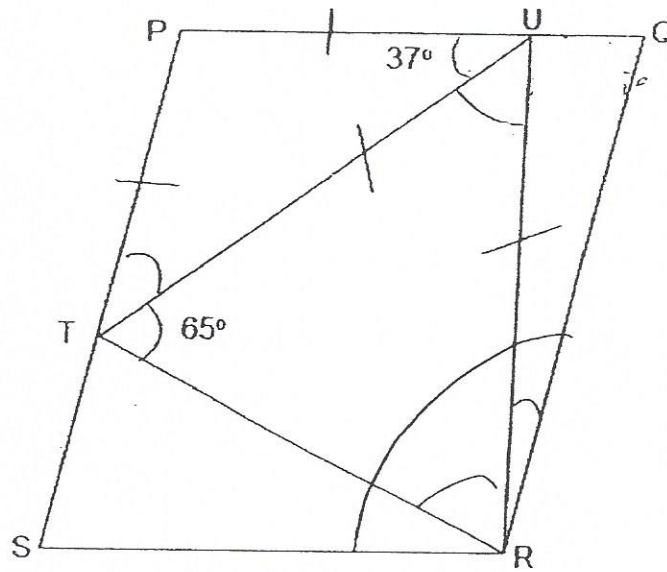

Do not write in this space

Ans: (a) \_\_\_\_\_ [1]

(b) \_\_\_\_\_ [3]



15 At 4.30 p.m., Keith started cycling from Town A to Town B at an average speed of 60 m/min. At the same time, Maine started cycling from Town B to Town A at a constant speed. Keith had covered  $\frac{3}{5}$  of the distance when he passed Maine at 6.30 p.m. Find the distance between Town A and Town B.

Do not write in this space

Ans: \_\_\_\_\_ [4]

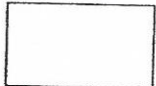



16

The patterns below are made up of identical shaded and unshaded squares.

Do not write in this space

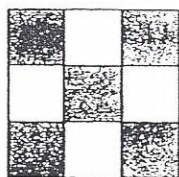

Pattern 1

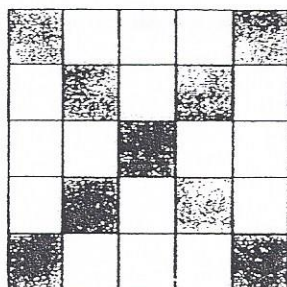

Pattern 2

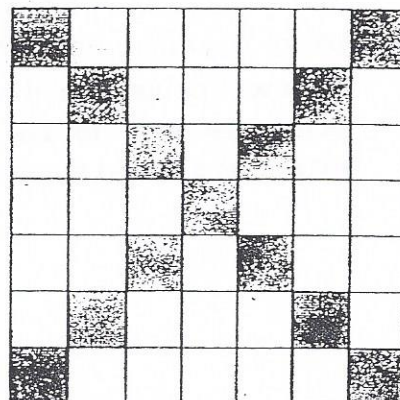

Pattern 3

- (a) Find the total number of squares in Pattern 4.
- (b) Find the total number of shaded squares in Pattern 10.
- (c) Find the total number of unshaded squares in Pattern 43.

Ans: (a) \_\_\_\_\_ [1]

(b) \_\_\_\_\_ [2]

(c) \_\_\_\_\_ [2]

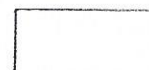

17

A rectangular tank measuring 400 cm by 200 cm by 150 cm was  $\frac{1}{3}$  filled with water. A tap was turned on to fill the tank with water at a rate of  $20\ell/\text{min}$ . Every 2 minutes after the tap was turned on,  $8\ell$  of water was poured into the tank from a pail. How long did it take for the rectangular tank to be completely filled with water? Leave your answer as a mixed number in its simplest form.

Do not write in this space

Ans: \_\_\_\_\_ [5]

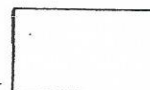

- 18 In a ballroom, the ratio of the <sup>were added</sup> number of gold balloons to red balloons was 4 : 3. The ratio of the number of silver balloons to red balloons was 3 : 5. 10% of the gold balloons burst and were replaced by another 132 silver balloons. As a result, the percentage of the number of red balloons became 20% of the total number of balloons. How many balloons were there in the ballroom at first?

Do not write in this space

Ans: \_\_\_\_\_ [5]

-- End of Paper 2 --

Faint, illegible text at the top of the page, possibly a header or title.

Faint, illegible text at the bottom of the page, possibly a footer or page number.



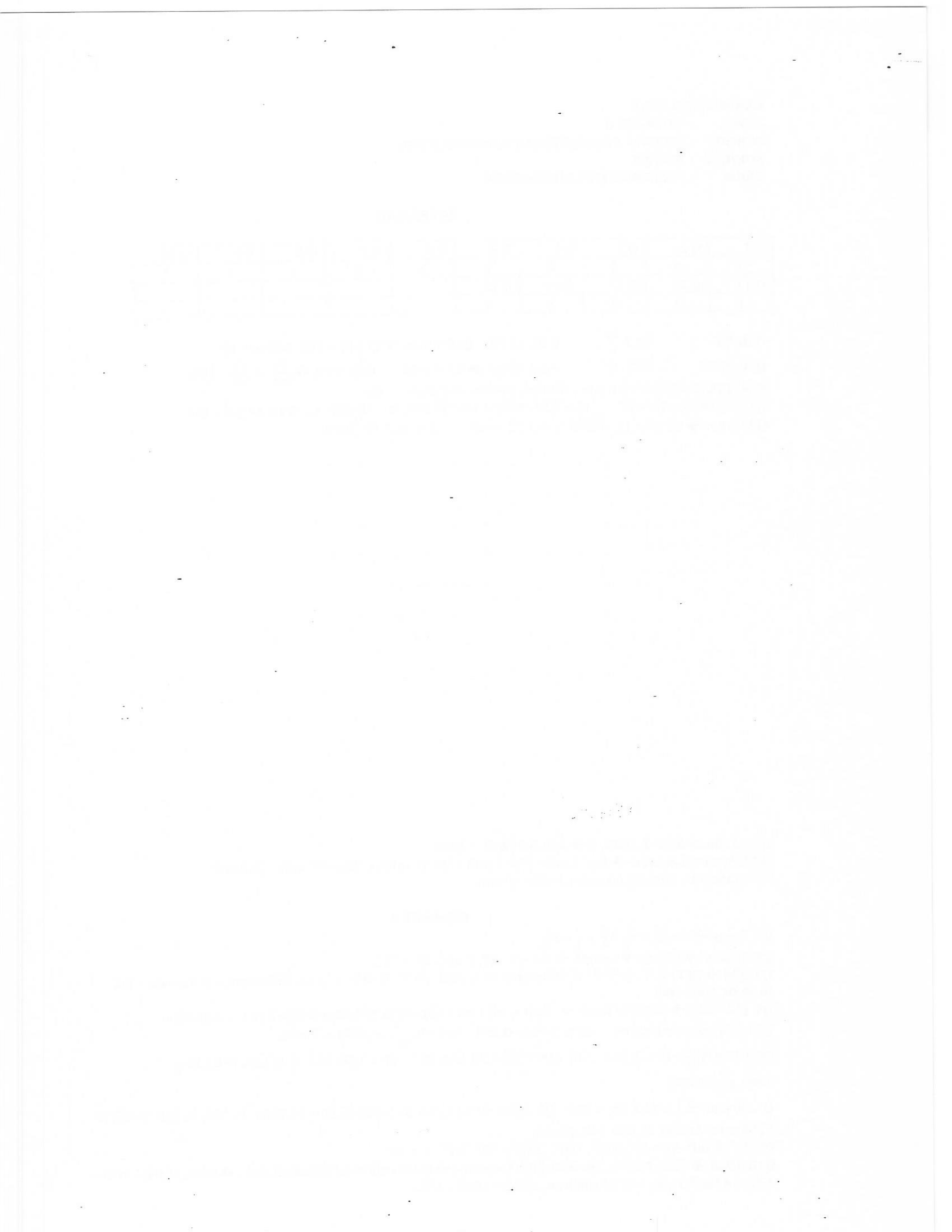



- Q11. 238 → purse → \$39, wallet →  $439 \times \frac{1}{3} = \$26$ , SOLD P → \$117U, W → \$104U → P : W, 3U : 4U, TOTAL 7U, UNSOLD → 14U, \$117U + 104U = \$2221U, \$221 → \$3757, U → 417, \$17 x \$117U → \$1989U, \$1989 ÷ \$39 = 51 PURSES, \$17 X \$104U = \$1768U, \$1768 ÷ \$26 = 68 WALLETS, 68 + 51 = 119 (1/3 of items), 119 x 2 = 238
- Q12. 210 →  $312 \div 26u = 12$ ,  $12 \times 17.5 = 210$ .
- Q13. 51cm →  $462 - 198 = 264$ ,  $78 - 42 = 36$ ,  $264 - 36 - 78 = 264$ ,  $78 - 42 = 36$ ,  $264 - 36 - 78 = 150$ ,  $150 \div 2 = 75$ ,  $75 - 24 = 51$ .
- Q14a.  $50^\circ \rightarrow 180^\circ - (65^\circ \times 2) = 50^\circ$
- Q14b.  $13^\circ \rightarrow \angle QUR \rightarrow 180^\circ - 37^\circ - 50^\circ = 93^\circ$ ,  $\angle TPU \rightarrow 180^\circ - 37^\circ - 37^\circ = 106^\circ$ ,  $\angle UQR \rightarrow 180^\circ - 106^\circ = 74^\circ$ ,  $\angle URQ \rightarrow 180^\circ - 93^\circ - 74^\circ = 13^\circ$ .
- Q15. 12,000m →  $60m \times 120min = 7200m$ ,  $7200m \div 3 = 2400m$ ,  $2400m \times 5 = 12,000m$ .
- Q16a. 81 → P1 → total: 9,  $1+2=3$ ,  $3 \times 3 = 9$ , P4 → Total: ?,  $4 + 5 = 9$ ,  $9 \times 9 = 81$ .
- Q16b. 41 →  $(10 \times 4) + 1 = 41$ . Q16c. 7396 → Shaded →  $43 \times 4 + 1 = 173$ , Total →  $43 + 44 = 87$ ,  $87 \times 87 = 7569$ ,  $7569 - 173 = 7396$ .
- Q17.  $335\frac{3}{5}mins \rightarrow$  Every 2 mins = 8litre, 1 min = 4litre, 2mims →  $20l \times 2 + 8l = 48litre$ ,  $8000ml \div 48litre = 166R32L$ , 32litre ÷ 20litre per min =  $1\frac{3}{5}min$ ,  $(166 \times 2) + 1\frac{3}{5} = 333\frac{3}{5}min$ .
- Q18.  $176 \rightarrow 15U \times 5 = 75U$ ,  $75U - 15U - 18U - 9U = 33U$ ,  $33U \rightarrow 132$ , U → 4,  $4 \times (15U + 20U + 9U) = 176$

THE END

