



**HILLGROVE SECONDARY SCHOOL
END-OF-YEAR EXAMINATION 2019
SECONDARY 3 EXPRESS**

CANDIDATE
NAME

 ()

CLASS

 -

CENTRE
NUMBER

S				
---	--	--	--	--

INDEX
NUMBER

--	--	--	--

SCIENCE (PHYSICS)

5076

Physics

8 Oct 2019

1 hour 15 min

Candidates answer on the Question Paper.

9.15 AM – 10.30 AM

No Additional Materials are required.

READ THESE INSTRUCTIONS FIRST

Write your class, index number and name on the work you hand in.
You may use an HB pencil for any diagrams, graphs, tables or rough working.
Write in dark blue or black pen.
Do not use staples, paper clips, glue or correction fluid.

The use of an approved scientific calculator is expected, where appropriate.
You may lose marks if you do not show your working or if you do not use appropriate units.

Section A

Answer **all** questions

Write your answers in the spaces provided on the question paper.

Section B and C

Answer **all** questions

Write your answers in the space provided on the question paper.

The number of marks is given in brackets [] at the end of each question or part question.

For Examiner's Use

Section	Marks
A	/ 15
B	/ 35
C	/ 10
TOTAL	/ 60

Parent's/ Guardian's Signature: _____

Setter: Mr Barnabas Tan

This document consists of **20** printed pages.

Section A [15 marks]

Write your answers to Section A in the spaces provided below.

Q1	Q2	Q3	Q4	Q5	Q6	Q7	Q8	Q9	Q10

Q11	Q12	Q13	Q14	Q15

- 1 The diagram shows the reading on a micrometer screw gauge.

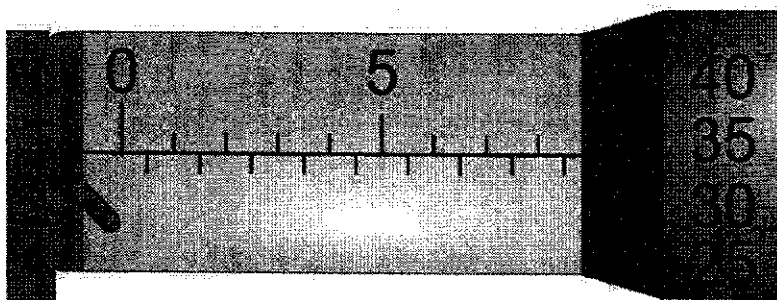

What is the reading shown?

- A 8.34 mm B 8.84 mm C 9.34 mm D 12.34 mm
- 2 The diagram shows part of a vernier calipers with a zero error of -0.02 cm.

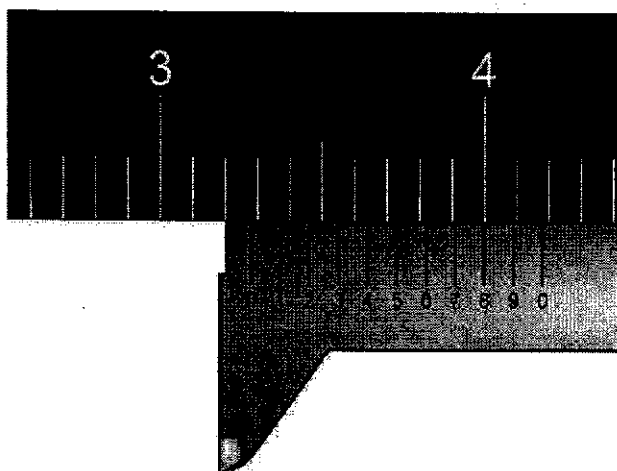

What is the corrected reading on the vernier scale, taking into account the zero error?

- A 3.20 cm B 3.22 cm C 3.28 cm D 3.30 cm

3 Which quantities are both vectors?

- A acceleration and energy
- B distance and velocity
- C distance and time
- D velocity and acceleration

4 The width of a typical human hair is around 150 micrometres, while the distance from the earth to the moon is around 380 000 km.

Which row gives the width of human hair in nanometres and the distance from the earth to the moon in metres?

	width of human hair / nm	distance from earth to moon / m
A	150 000 000 000	380 000 000
B	150 000	380 000 000
C	150 000 000 000	380 000
D	150 000	380 000

5 The speed-time graph represents the movement of a body accelerating from rest for the period $t = 0$ s to $t = 5.0$ s.

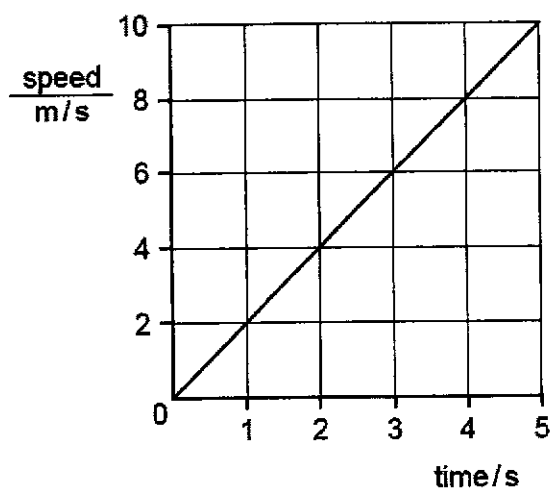

What is the distance travelled by the body for the period $t = 0$ s to $t = 3.0$ s?

- A 9.0 m
- B 18 m
- C 25 m
- D 50 m

- 6 The diagram shows a skydiver falling towards the ground with two forces acting on the skydiver.

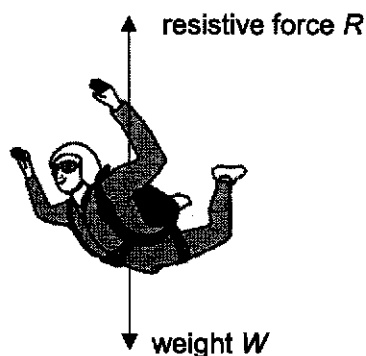

When weight W equals resistive force R , which statement is correct?

- A The skydiver is moving with non-uniform acceleration.
 - B The skydiver is moving with uniform acceleration.
 - C The skydiver is moving with uniform velocity.
 - D The skydiver is slowing down.
- 7 A box of mass 10 kg is pushed across the floor with a force of 54 N. The total frictional force acting on the box is 14 N.

What is the acceleration of the box?

- A 4.0 m/s²
 - B 5.4 m/s²
 - C 6.8 m/s²
 - D 10 m/s²
- 8 A body of weight 120 N on Earth has a weight of 96 N on planet X.

Given that the gravitational field strength on Earth is 10 N/kg, what is the gravitational field strength on planet X?

- A 0.80 N/kg
- B 8.0 N/kg
- C 9.6 N/kg
- D 12 N/kg

- 9 Two cylinders P and Q are made of the same material.

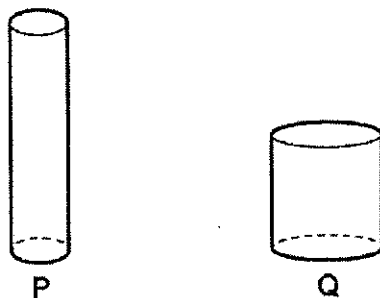

The height of P is twice the height of Q. The diameter of P is half the diameter of Q. The mass of Q is twice the mass of P.

Which statement is correct?

- A The density of cylinder P is four times that of cylinder Q.
 - B The density of cylinder P is twice that of cylinder Q.
 - C The density of cylinder P is equal to that of cylinder Q.
 - D The density of cylinder P is half that of cylinder Q.
- 10 The diagram shows a uniform beam pivoted at its centre. The beam is balanced by three weights in the positions shown.

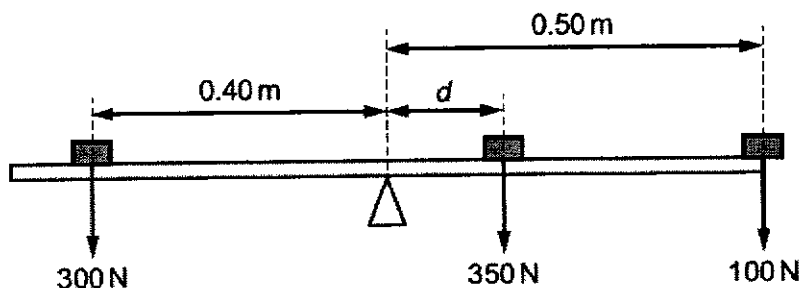

What is the distance d ?

- A 0.020 m
- B 0.050 m
- C 0.20 m
- D 0.48 m

- 11 Four objects of equal mass rest on a table. The centre of gravity of each object is labelled G.

Which object is the least stable?

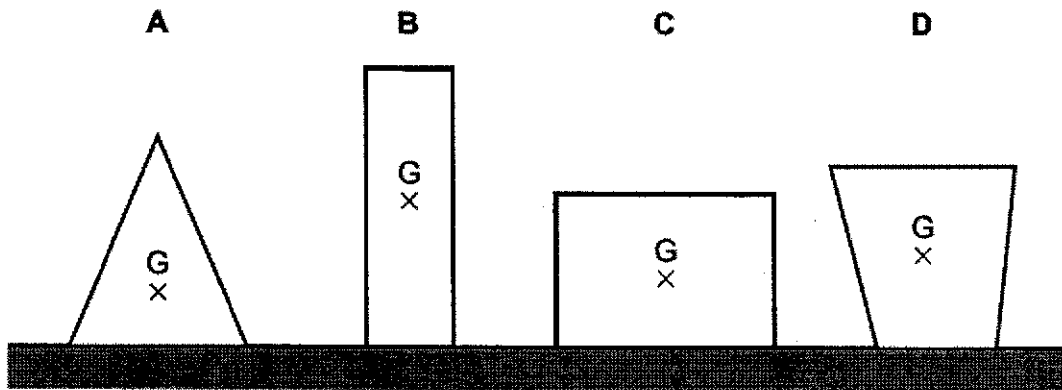

- 12 When a 300 N force is applied to a box weighting 600 N, the box moves 3.0 m horizontally.

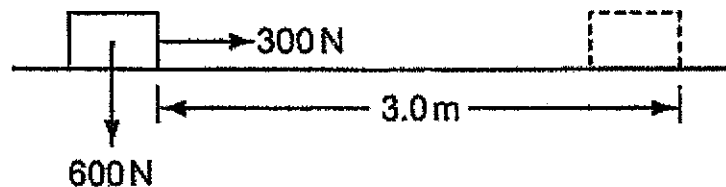

What is the work done by the 300 N force?

- A 100 J B 200 J C 900 J D 1800 J
- 13 A car of mass 1500 kg slows down from 30 m/s to 22 m/s as it approaches the traffic police speed camera.

What is the decrease in its kinetic energy?

- A 48 000 J B 96 000 J C 312 000 J D 624 000 J

14 Which statement is correct?

- A Infrared radiation cannot travel in vacuum.
- B Infrared radiation cannot travel in solids or in gases.
- C Infrared radiation can only travel in vacuum.
- D Infrared radiation can travel in vacuum and in gases.

15 The diagram shows a patient having her eyes tested. A chart with letters on it is placed behind her and she sees the chart reflected in a plane mirror.

The patient is told to move 0.50 m away from the plane mirror.

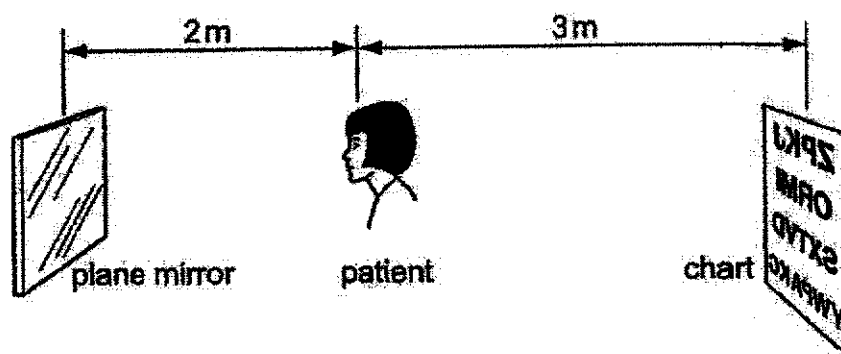

What is the distance between the patient and the image of the chart now?

- A 2.5 m
- B 4.5 m
- C 7.0 m
- D 7.5 m

Section B [35 marks]

Answer all the questions in this section. Answer in the spaces provided.

- 1 An aeroplane flies through the air in a straight line, with its engines at full power. The weight of the aeroplane is 160 kN and this acts vertically downwards.

There is also a force of 320 kN acting upwards on the aeroplane at 30° to the horizontal.

By using a scaled vector drawing, determine the magnitude of the resultant of these two forces.

Note: Diagram is drawn to scale.

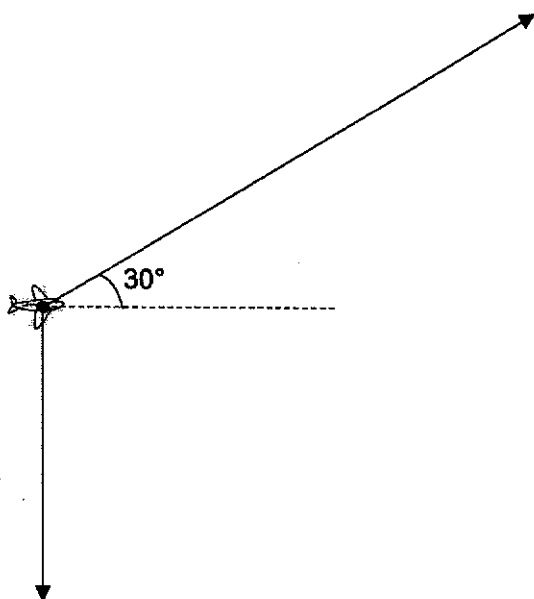

Scale: 1 cm represents kN

Magnitude of resultant force = kN [3]

- 2 Fig. 2.1 shows the distance-time graph for a journey made by a cyclist between town A and town B.

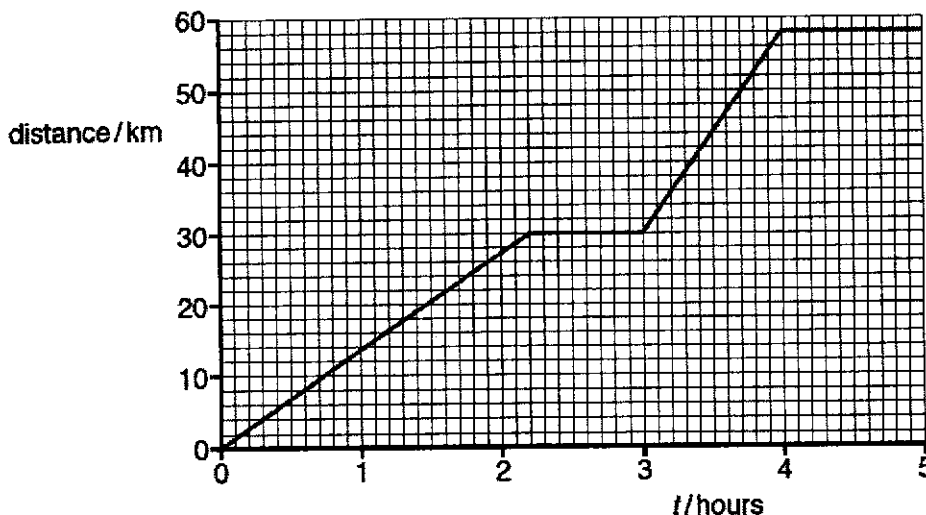

Fig. 2.1

The cyclist leaves town A at time $t = 0$ and arrives at town B at $t = 4.0$ hours.

- (a) Determine the distance between the two towns.

distance = km [1]

- (b) Calculate the average speed of the cyclist for the journey from A to B.

average speed = km/h [1]

- (c) The speed of the cyclist near the end of the journey is greater than the speed at the beginning. State how the graph shows this.

.....
 [1]

- 3 Fig. 3.1 shows a skydiver falling vertically towards the ground.

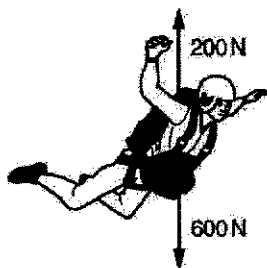

Fig. 3.1

The weight of the parachutist is 600 N.

The gravitational field strength is 10 N/kg.

Calculate the acceleration of the parachutist when the air resistance is 200 N, as shown in Fig. 3.1.

acceleration = m/s² [3]

- 4 Fig. 4.1 shows a student sitting on a chair. Fig. 4.2 shows the same student with his chair tilted backwards slightly.



Fig. 4.1



Fig. 4.2

- (a) State and explain how the pressure of the chair on the floor differs in the two positions.

.....

.....

.....

..... [2]

- (b) The chair and student fall over if the chair is tilted backwards more than the position shown in Fig. 4.2.

Explain why.

.....

.....

.....

..... [2]

- 5 A bucket of water is pulled up out of a well using a rope. Fig. 5.1 shows the rope winding on to a cylinder as the handle is turned.

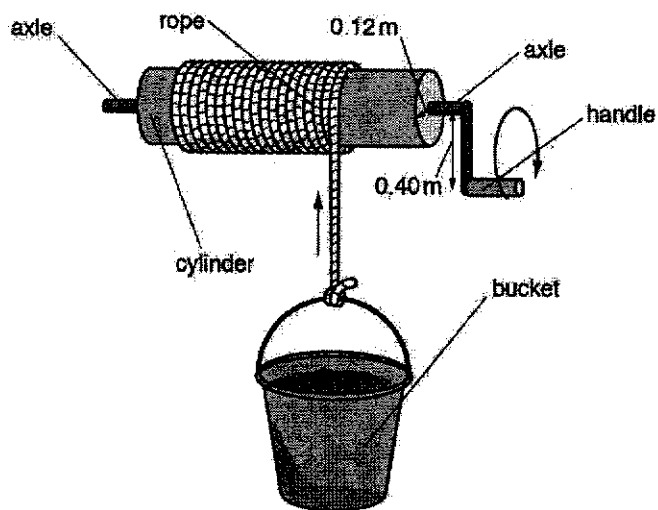

Fig. 5.1

- (a) The empty bucket has a mass of 1.0 kg.

When the bucket is full, it contains 0.024 m^3 of water. The gravitational field strength g is equal to 10 N/kg .

The density of water is 1000 kg/m^3 .

Determine the total weight of the bucket that is full of water.

weight = N [2]

- (b) Fig. 5.2 shows the side-view of the cylinder. The radius of the cylinder is 0.12 m and the handle is 0.40 m from the axle of the cylinder.

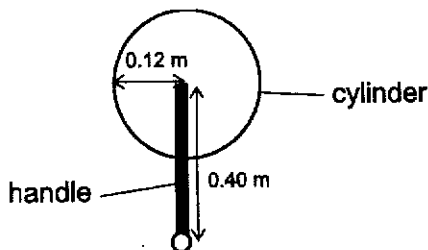

Fig. 5.2

The weight of the bucket and the water produce a moment that acts on the cylinder.

- (i) State the *principle of moments* for a body in equilibrium.

.....
[1]

- (ii) Calculate the moment produced by the weight of the bucket that is full of water.

moment = Nm [1]

- (iii) Calculate the minimum force that needs to be applied on the handle to balance this moment.

minimum force = N [1]

- (c) Suggest a modification to the set-up so that the same load can be lifted with a smaller force.

..... [1]

- (c) The outside surface of the cup can be either black or white, and can be either dull or shiny.

State and explain which colour and which type of surface is best to keep the coffee warm.

.....
.....
..... [2]

- 7 Fig. 7.1 shows two rays from an object that is placed in front of a plane mirror.

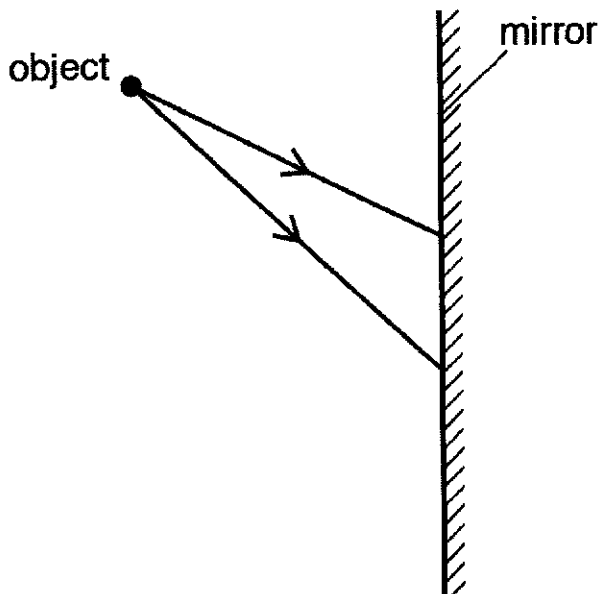

Fig. 7.1

- (a) Complete the ray diagrams in Fig. 7 to locate the position of the image formed. [2]

- (b) Apart from its position, state one other characteristic of the image.

.....[1]

- 8 Fig. 8.1 shows light in air, striking the vertical side of a rectangular glass block at an angle of incidence of 60° .

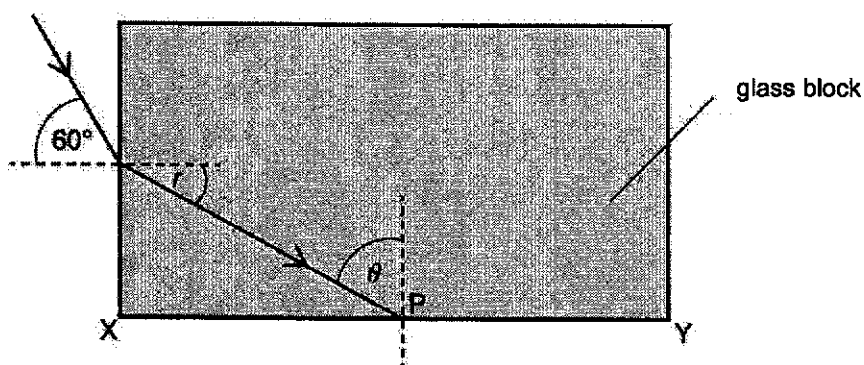

Fig. 8.1

The refractive index of the glass is 1.60.

- (a) At the point where the light enters the glass block, the angle of refraction is r .

Calculate angle r .

angle $r = \dots\dots\dots^\circ$ [2]

- (b) The light travels in the glass block and strikes side XY at P.
- (i) Calculate the critical angle c for light travelling in the block.

critical angle $c = \dots\dots\dots^\circ$ [2]

- (ii) At P, the angle θ between the ray and the normal is given by $\theta = 90^\circ - r$.

State and explain what happens to the light ray when it strikes side XY.

.....

.....

.....

.....[2]

Section C [10 marks]

Answer all the questions in this section. Answer in the spaces provided.

9 A substance was heated in an enclosed space until it became a gas.

After the heater was removed, the temperature of the substance was recorded at regular intervals. Fig. 9.1 shows the graph of temperature plotted against time.

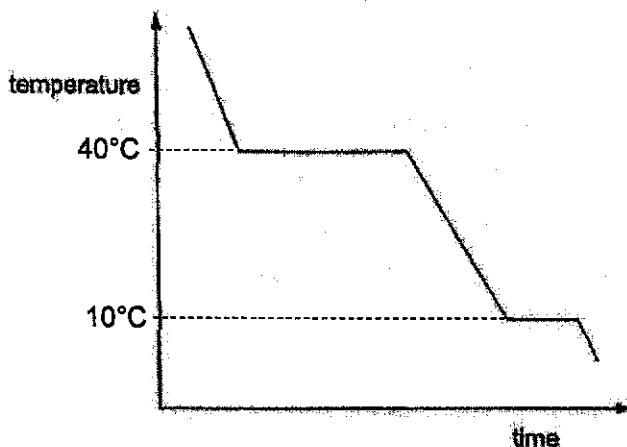

Fig. 9.1

(a) Describe the **changes**, if any, that occur to the arrangement and to the motion of the molecules of the substance

(i) as it cools from 80°C to 41°C,

arrangement of molecules

.....

motion of molecules

.....

[2]

(ii) as it condenses at 40°C,

arrangement of molecules

.....

motion of molecules

.....

[2]

(iii) as it freezes at 10°C.

arrangement of molecules

.....

[1]

(b) A syringe was used to contain a sample of the substance in liquid state as shown in Fig. 9.2.

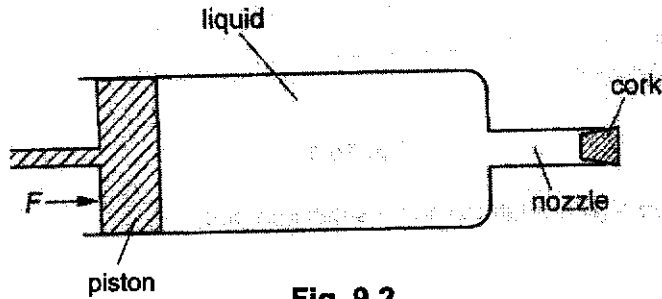

Fig. 9.2

There is a cork fixed in the nozzle of the syringe, as shown in Fig. 9.2.

(i) The liquid in the syringe cannot be compressed. Explain why gases can be compressed but liquids cannot.

.....

..... [1]

(ii) A force F is applied to the piston in the direction shown. State and explain how the force on the cork compares to force F .

.....

.....

.....

..... [2]

(c) The cork in the nozzle of the syringe became dislodged and some of the liquid spilled onto Mr Tan's hand. Suggest a reason for each of the following observations.

(i) the liquid disappeared after some time,

reason
.....[1]

(ii) Mr Tan's hand felt cool.

reason
.....[1]

END OF PAPER

MARKERS' REPORT FOR 2019 S3E SCIENCE (PHYSICS) EOY

SECTION A

Q1	Q2	Q3	Q4	Q5	Q6	Q7	Q8	Q9	Q10
B	D	D	B	A	C	A	B	C	C
Q11	Q12	Q13	Q14	Q15					
B	C	C	D	D					

SECTION B

QN.	SUGGESTED SOLUTION	MARKER'S COMMENTS
1	<p>Scale: 1 cm represents <u>40</u> kN</p> <p>Magnitude of resultant force = <u>276 ± 6</u> kN</p> <p>Resultant vector should be a solid line with double arrow heads; component vectors should have arrow heads indicated in the correct direction</p>	Students are reminded to indicate the resultant vector with a solid line and a double headed arrow.
2(a)	Distance between the two towns = 58 km	Some students misread the scale and indicated 59 km.
2(b)	Average speed = $58 / 4 = 14.5$ km/h	Some students divided 58 km by 5 hours. It should be noted that the car first reached Town A after 4 hours.
2(c)	The gradient of the graph near the end of the journey is <u>steeper</u> than the gradient of the graph at the beginning.	Many students were able to identify the change in steepness of the gradient as the determining factor.
3	<p>Resultant force = $600 - 200 = 400$ N</p> <p>Acceleration = $400 / (600 + 10) = 6.67$ m/s²</p>	<p>Students were first required to determine the resultant force by taking the difference between the two forces.</p> <p>They were then expected to apply the relationship $F_{\text{net}} = ma$ to obtain the acceleration.</p> <p>Some students still left their answers in fractions.</p>

QN.	SUGGESTED SOLUTION	MARKER'S COMMENTS
		Students are reminded to leave their final answers to 3 significant figures.
4(a)	<p>The pressure of the chair on the floor is greater in Fig. 4.2.</p> <p>The area in contact with the floor is smaller.</p>	<p>Students are reminded to read the question carefully and to answer the different parts of a question, e.g. state and explain.</p> <p>In this case, students were required to make reference to the area in contact with the floor. Simply stating that surface area is greater/ smaller was insufficient as it is the surface area <u>in contact with the floor</u> that determines the pressure exerted.</p>
4(b)	<p>The line of action of the student's weight falls to the left of the chair's leg.</p> <p>This gives rise to a counter-clockwise moment about the point of contact with the floor, causing the student to fall over.</p>	<p>Few students made reference to the line of action of the person's weight falling outside of the base area, or to the left of the chair's leg.</p>
5(a)	<p>Mass of water $= \text{density} \times \text{volume}$ $= 1000 \times 0.024$ $= 24 \text{ kg}$</p> <p>Total weight of the bucket & water $= (24 + 1) \times 10$ $= 250 \text{ N}$</p>	<p>Some students forgot to include the mass of the empty bucket. The question had asked for the 'total weight of the bucket that is full of water'.</p> <p>A few students were unable to apply the correct formula to calculate the mass of water.</p>
5(bi)	<p>For a body in equilibrium, the <u>sum of clockwise moments equals to the sum of anti-clockwise moments</u> about the same point.</p>	<p>The phrase 'sum of' was omitted by some students.</p>
5(bii)	<p>Moment = $250 \times 0.12 = 30 \text{ Nm}$</p>	<p>Some students multiplied the weight of the bucket & water with 0.40 m.</p>
5(biii)	<p>$30 = \text{force} \times 0.40$</p>	<p>Similarly, some students divided their answer in 5(bii) by 0.12.</p>

Q.N.	SUGGESTED SOLUTION	MARKER'S COMMENTS
5(c)	<p>Minimum force required = 75 N</p> <p>Use a longer handle/ Extend the handle</p> <p>OR</p> <p>Use a cylinder with a smaller cross-sectional area</p>	<p>Answers like 'increase the size of the handle' or 'make the cylinder smaller' are too generic to be awarded credit.</p>
6(a)	<p>Thermal energy is transferred through the metal by the process of <u>conduction</u>.</p> <p>When particles in the cup are heated, they vibrate vigorously. They collide with neighbouring particles and transfer their energy. Eventually the particles at the cooler end are also set into vigorous vibration.</p> <p>Metals contain free electrons. Electrons gain kinetic energy and move rapidly through the metal. They coolide with atoms in the cooler parts of the metal and transfer their energy in the process.</p> <p>When coffee at the bottom of the cup is heated, it expands. When the volume of coffee increases, its density decreases. The expanded coffee is less dense than the surround coffee and rises.</p> <p>Since the upper region is cooler, it is denser and therefore sinks. The difference in the densities of cofefe in the different regions sets up a convection current.</p>	<p>Students are reminded that the process of conduction involves vibration <u>and</u> collision of particles in the transfer of thermal energy.</p> <p>Some students forgot to mention the role of free electrons in the transfer of thermal energy.</p>
6(b)	<p><u>Air is a poor conductor</u> of thermal energy.</p> <p>The thin layer of air at the bottom of the cup in Fig. 6.2 reduces the transfer of thermal energy to the cup.</p>	<p>it was important for students to highlight the significance of the presence of the layer of air.</p> <p>Other acceptable answers include the explanation that air particles are far apart.</p>

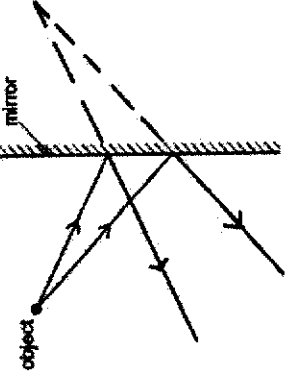
Qn.	SUGGESTED SOLUTION	MARKER'S COMMENTS
6(c)	<p>A shiny white surface would be best to keep the coffee warm. A shiny white surface is a poor emitter of thermal radiation.</p>	<p>Students are reminded that they are expected to identify whether the surface is behaving as an emitter or absorber, depending on the context.</p>
7(a)	 <p>object</p> <p>mirror</p>	<p>Most students were able to correctly identify the position of the image. But they were unable to construct the reflected ray and the</p>
7(b)	<p>Same size Laterally inverted Upright Virtual</p>	<p>This part was generally well-answered.</p>
8(a)	<p>$1.00 \sin 60^\circ = 1.60 \sin r$ $r = 32.8^\circ$</p>	<p>Many students were able to obtain the correct value for r. Some students mistakenly used 1.50 as the refractive index of the glass.</p>
8(bi)	<p>$1.60 \sin c = 1$ $c = 38.7^\circ$</p>	<p>Some students mistakenly used 1.50 as the refractive index of the glass.</p>
8(bii)	<p>$\theta = 90^\circ - r = 57.2^\circ$ The light ray undergoes total internal reflection at point P because the angle of incidence is greater than the critical angle.</p>	<p>Students are reminded that the phenomenon is called 'total internal reflection' and not 'total internal refraction'.</p>

SECTION C

QN.	SUGGESTED SOLUTION	MARK(S) AWARDED
9(ai)	<p>No change to the arrangement of molecules. Average separation of the molecules remains the same.</p> <p>The molecules move slower.</p>	<p>Many students did not realise that they were expected to describe the changes to the arrangement and motion of the substance.</p> <p>An answer that merely describes the arrangement of molecules in a gas is not answering the question.</p>
9(aii)	<p>The molecules move closer together.</p> <p>No change to motion of molecules. Average speed/ kinetic energy of the molecules remains the same.</p>	<p>Students are reminded that a key change in the arrangement of molecules when there is a change of state from gas to liquid is the moving closer together.</p> <p>Many students failed to mention that there is no change to the motion of molecules.</p>
9(aiii)	<p>The molecules are arranged in a more orderly manner.</p>	<p>Students are reminded that the molecules in both solid and liquid state are arranged close together. The key change is that the arrangement of molecules becomes more orderly/ regularly arranged in the solid state.</p> <p>An answer that merely states that the particles are vibrating about fixed position is describing the motion of particles in the solid state, and is not answering the question.</p>
9(bi)	<p>Gas molecules are very far apart compared to liquid molecules which are close together.</p>	<p>Students are reminded that a key characteristic of gas molecules is that they are very far</p>
9(bii)	<p>Force on the cork will be smaller than F.</p> <p>Since liquid is incompressible, the pressure throughout the liquid will be the same. Hence, force applied is directly proportional to the cross-sectional area. Since cross-sectional area at nozzle is smaller, the force applied at the nozzle is smaller than F.</p>	<p>A common misconception among students was to state that the force is the same. Some students recognised that liquid is incompressible but failed to mention that the pressure exerted is the same through the liquid.</p> <p>An answer that does not compare the forces on cork and piston is not answering the question.</p>
9(c)	<p>Evaporation had taken place.</p>	<p>This part was generally well-answered.</p>

Q.N.	SUGGESTED SOLUTION	MARK(S) AWARDED
9(cii)	Energy had been absorbed from the surroundings (Mr Tan's hand) and used to overcome the forces of attraction due to the other molecules.	This part was generally well-answered.