



Rosyth School
Second Semestral Examination for 2013
SCIENCE
Primary 5

Name: _____

Class: Pr 5 - _____ Register No. _____ Duration: 1 h 45 min

Date: 28 October 2013 Parent's Signature: _____

Booklet A

Instructions to Pupils:

1. Do not open the booklets until you are told to do so.
2. Follow all instructions carefully.
3. This paper consists of 2 booklets, Booklet A and Booklet B.
4. For questions 1 to 30 in Booklet A, shade the correct ovals on the Optical Answer Sheet (OAS) provided using a 2B pencil.

*** This booklet consists of 17 pages.**

This paper is not to be reproduced in part or whole without the permission of the Principal.

3 The diagram below shows the human circulatory system.

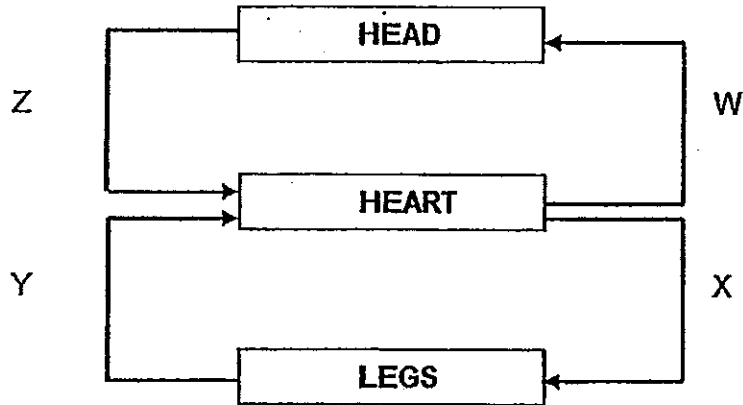

Which arrow(s) show(s) the flow of blood that is rich in oxygen?

- (1) X only
- (2) W and X only
- (3) Y and Z only
- (4) W, X, Y and Z

4 30 pupils entered an enclosed room with no windows or openings. Which of the following correctly shows the change in the amount of gases present in the room after some time?

	Oxygen	Carbon dioxide	Water Vapour
(1)	Increase	Decrease	Decrease
(2)	Decrease	Increase	Decrease
(3)	Increase	Decrease	Increase
(4)	Decrease	Increase	Increase

5 Which one of the followings shows the difference between the human and plant transport system correctly?

	Human Transport System	Plant Transport System
(1)	Involves a network of tubes	Does not involve a network of tubes
(2)	Does not circulate continuously	Circulates continuously
(3)	Involves a pumping action	Does not involve a pumping action
(4)	Carries food, water and air only	Carries food, water, air and mineral salts only

6 Study the human digestive system shown below.

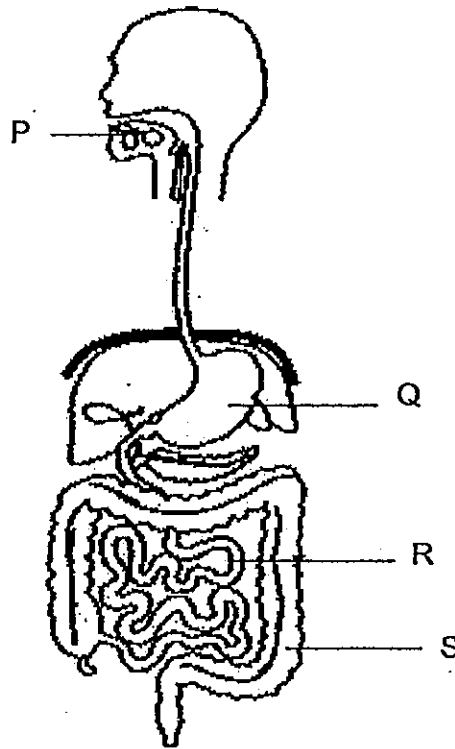

Which of the following correctly describes what happens at organs P, Q, R and S?

	Digestion takes place here	Water is absorbed into the bloodstream	Food is absorbed into the bloodstream
(1)	P, Q, R	S	R
(2)	Q, R	P	R
(3)	P, R, S	S	Q
(4)	R, S	Q	P

7 The diagram below shows how three human systems, D, E and F work together.

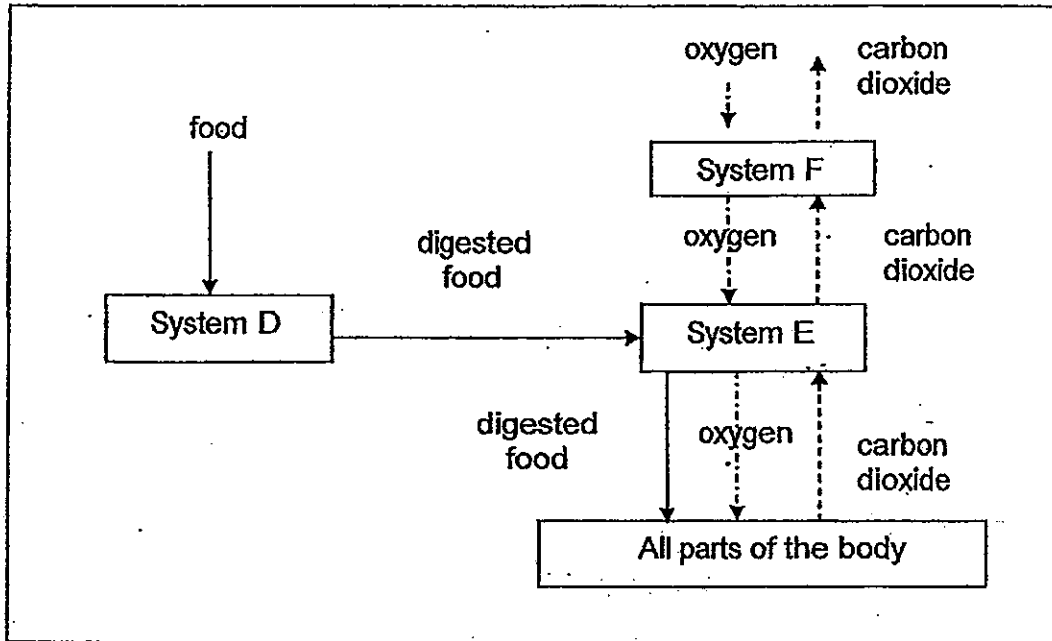

Which are the systems represented by D, E and F?

	D	E	F
(1)	Circulatory System	Digestive System	Respiratory System
(2)	Digestive System	Respiratory System	Circulatory System
(3)	Respiratory System	Circulatory System	Digestive System
(4)	Digestive System	Circulatory System	Respiratory System

8 A plant's roots are damaged. Which of the following function(s) cannot be performed?

- A: Absorbing sunlight
- B: Taking in water and mineral salts
- C: Holding the plant firmly to the ground

- (1) C only
- (2) A and B only
- (3) B and C only
- (4) A, B and C

9 Carol used a microscope and observed the underside of a leaf as shown below.

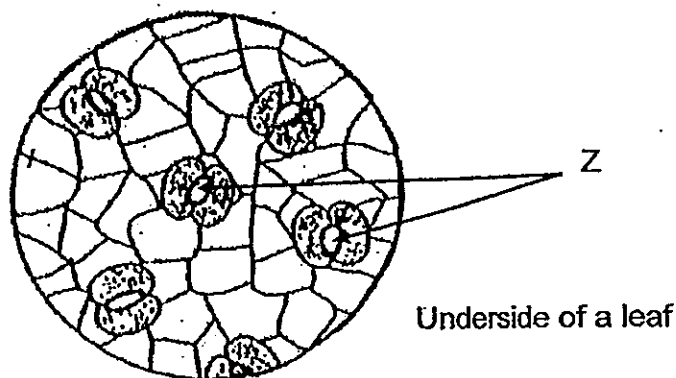

What is the function of opening Z?

- (1) It allows the plant to make food.
- (2) It takes in water needed to make food.
- (3) It transports the food made by the leaf to all parts of the plant.
- (4) It allows the plant to take in oxygen and give out carbon dioxide.

10 Study the flowchart below.

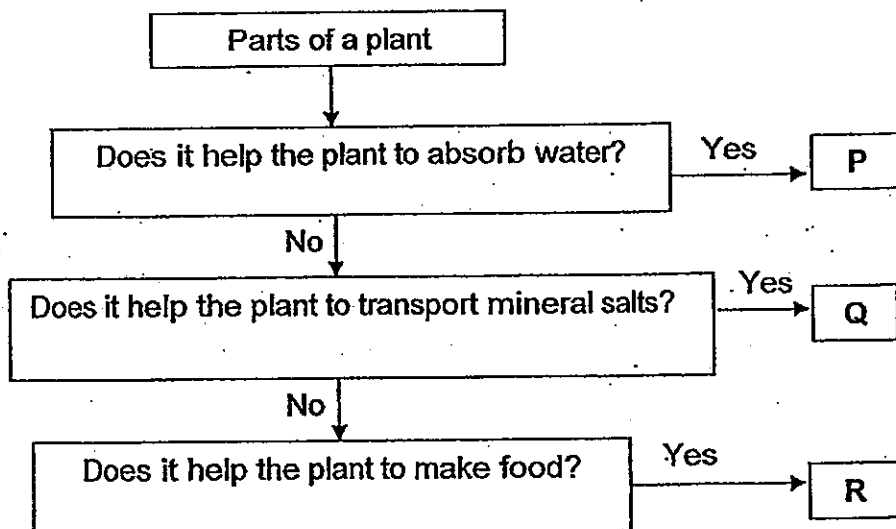

Which of the following correctly identifies P, Q and R?

	P	Q	R
(1)	Roots	Leaves	Food-carrying tubes
(2)	Roots	Water-carrying tubes	Leaves
(3)	Water-carrying tubes	Food-carrying tubes	Leaves
(4)	Roots	Food-carrying tubes	Leaves

11 Which one of the following diagrams shows a population?

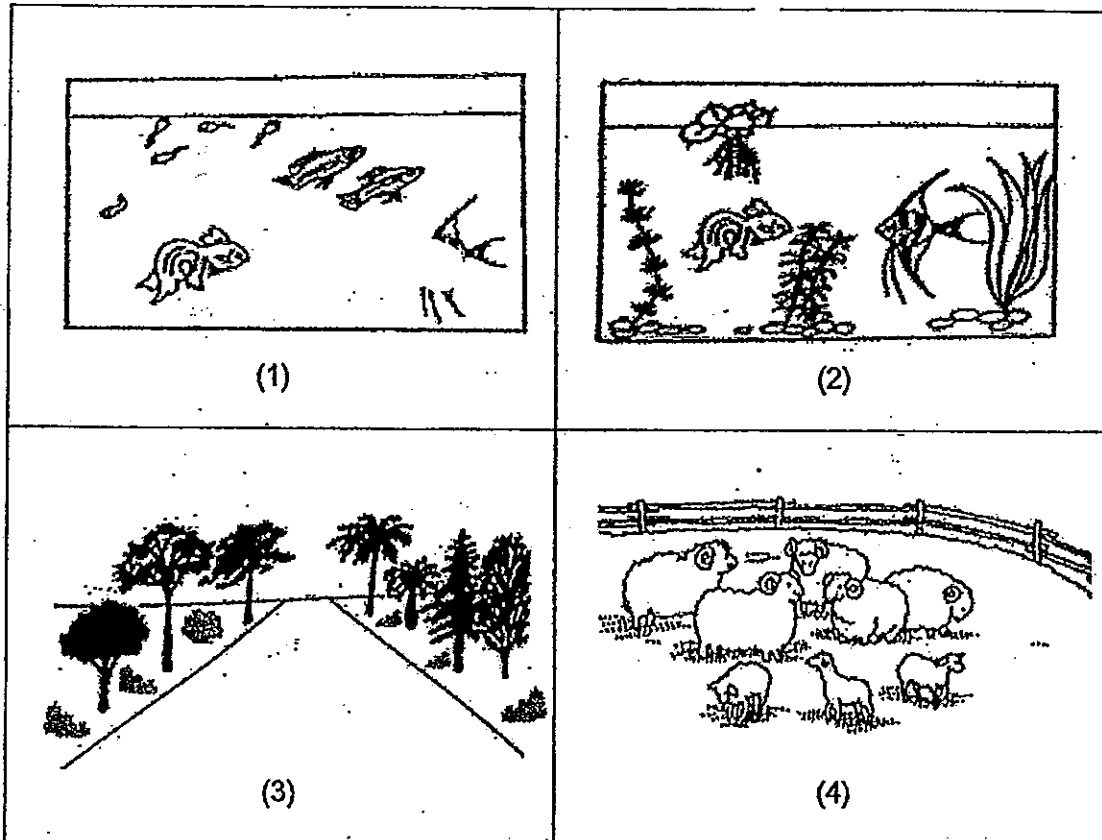

12 James wanted to test the effect of overcrowding on the growth of plants. He conducted the experiment using identical pots A and B. The table below shows some conditions for the experiment.

Pot	Number of seedlings	Amount of water (ml)	Amount of soil (g)
A	4	Y	Z
B	X	10	450

Which of the following best represent X, Y and Z?

	X	Y	Z
(1)	4	7	450
(2)	4	10	300
(3)	16	7	300
(4)	16	10	450

13 Study the food chain below.



Which of the following correctly describes the food relationships of the organisms in the food chain above?

	J	K	L	M
(1)	Prey	Predator	Prey and Predator	Producer
(2)	Prey	Predator	Producer	Predator
(3)	Producer	Prey	Prey and Predator	Predator
(4)	Producer	Prey and predator	Prey	Predator

14 Study the information below about two populations of organisms.

- C helps to control the population of D.
- If the population of C decreases, the population of D will increase.

Which one of the following represents C and D correctly?

	C	D
(1)	Herbivore	Producer
(2)	Predator	Producer
(3)	Prey	Predator
(4)	Decomposer	Consumer

15 Study the food chain below.

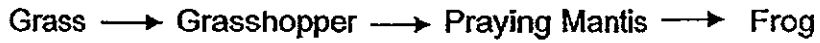

If the praying mantis is removed from the food chain above, which one of the graphs below shows the changes in the other three population?

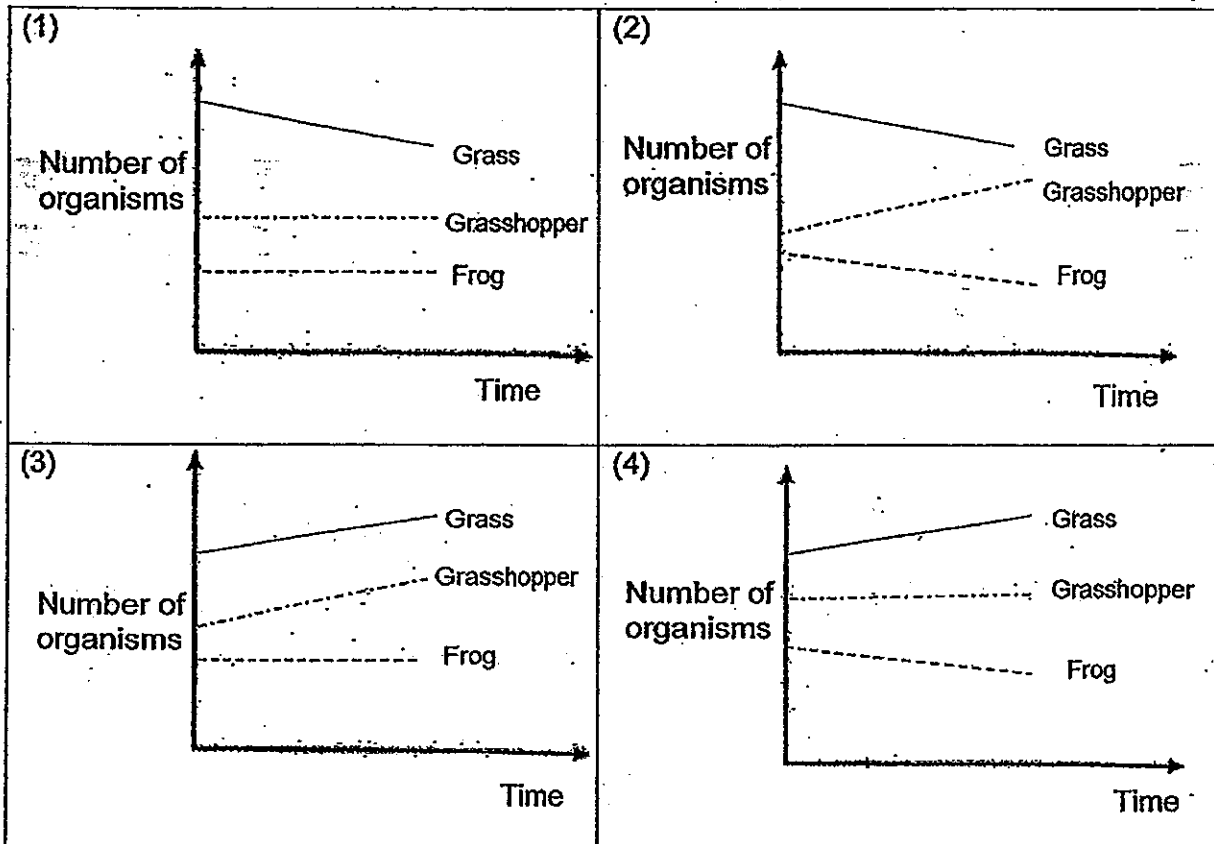

16 Which of the following features allows a carnivore to tear and kill their prey?

- A: Sharp teeth
- B: Claws
- C: Webbed feet

- (1) A only
- (2) B only
- (3) A and B only
- (4) A and C only

Rosyth School/ P5 Standard Science /Semestral Assessment 2/ 2013

17 Which of the following can be the adaptive features of plants to survive the harsh conditions in a desert?

- A: Needle-like leaves
- B: Extensive shallow root system
- C: Storage stems that can store water

- (1) A only
- (2) A and C only
- (3) B and C only
- (4) A, B and C

18 Which one of the following adaptive features is correctly matched with its function?

	Adaptive feature	Function
(1)	Thick fur coat	For fast gliding movement on ice
(2)	Long sticky tongue	To catch prey from far easily
(3)	Layer of fat below the skin	To camouflage from prey
(4)	Waxy leaves	To collect water on the leaves

- 19 A camel has large padded feet to enable it to walk on the desert sand and to prevent it from sinking into the sand.

Anthony conducted an investigation to determine this fact using blocks, P, Q, R and S. The blocks are of same mass but of different sizes. He placed the blocks in a tray of plasticine. He placed identical weights on the blocks as shown below.

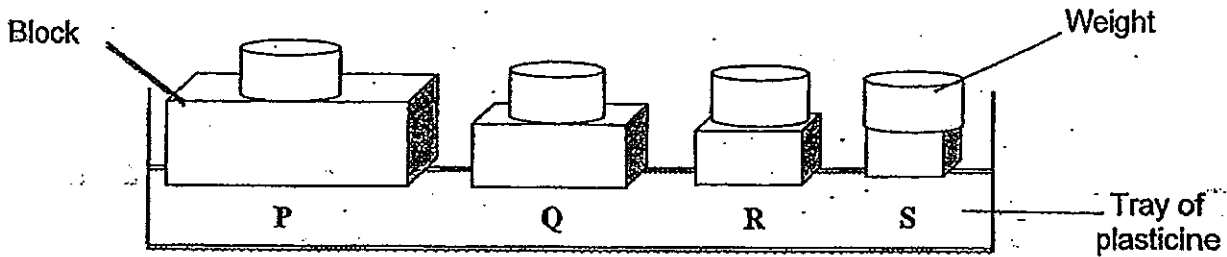

He removed the wooden blocks from the tray and measured the dent created as shown below.

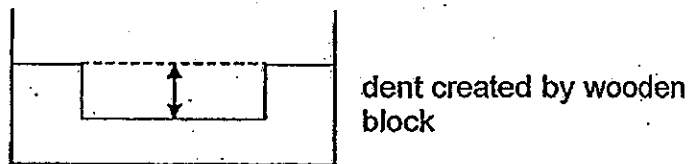

Which one of the wooden blocks would have created the greatest dent in the tray of plasticine?

- (1) P (2) Q
(3) R (4) S

20 Two birds, A and B, were kept separately in two cages as shown below.

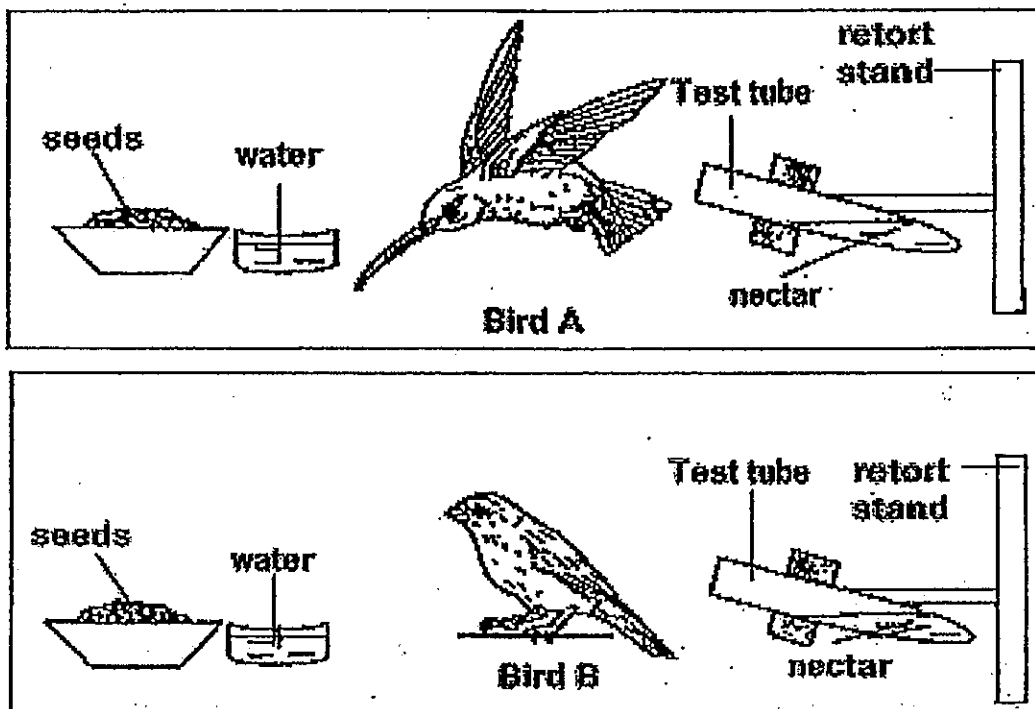

Jayden wanted to find out if the type of beak will affect the type of food eaten by birds. 50 ml of nectar and 50g of seeds were placed in each cage at the start of the experiment. After two days, only the volume of nectar left was recorded. Which of the following correctly shows the volume of nectar left at the end of the experiment?

Volume of the nectar at the end of the experiment (ml)		
	A	B
(1)	40	20
(2)	30	50
(3)	50	30
(4)	20	40

23 Kevin wants to find out whether copper or steel wires can affect the brightness of a bulb. Which one of the following variables must he keep constant?

- A: Material of wire
- B: Length of wire
- C: Number of batteries
- D: Arrangement of bulbs

- (1) A and B only
- (2) C and D only
- (3) B, C and D only
- (4) A, B, C and D

24 The diagram below shows four circuits with different arrangements. The batteries are identical in all the circuits. The bulbs in all four circuits light up.

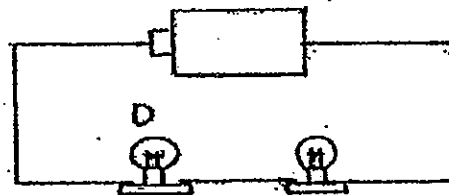
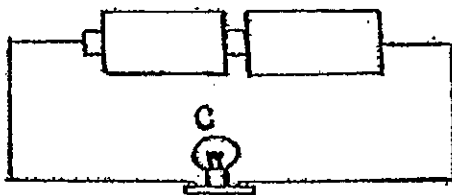
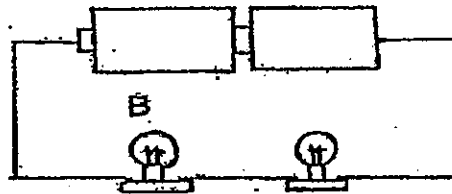
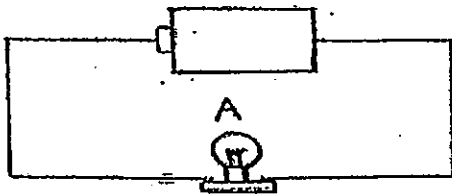

Which of the following shows the correct brightness of the bulbs?

Brightness of bulb		
Dimmest	Medium	Brightest
(1) D	A	B
(2) D	B	C
(3) B	C	D
(4) B	A	C

- 25 Alice set up the circuit below. She was told that one of the objects A, B, C or D in the circuit was an electrical insulator.

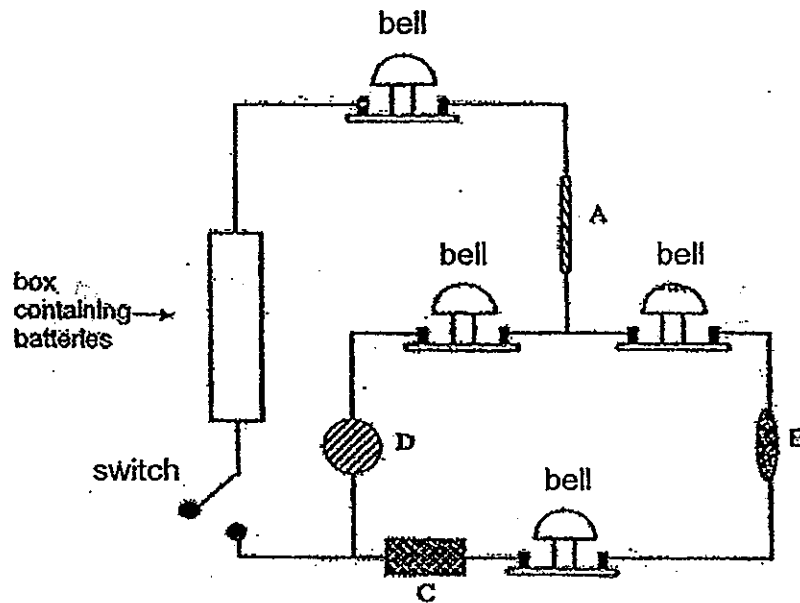

When she closed the switch, she observed that only 3 bells in the circuit rang. Which one of the 4 objects, A, B, C or D was the insulator?

- (1) A
 (2) B
 (3) C
 (4) D
- 26 Which of the following statements are true about friction?

A: It is a beneficial force only.
 B: It slows down motion.
 C: It causes things to wear out.
 D: It pulls all things towards the centre of the Earth.

- (1) A and C only
 (2) B and C only
 (3) A, B and C only
 (4) B, C and D only

- 27 The circuit showed Bulbs B1, B2 and object X. In the following circuit, B1 lighted up but B2 did not.

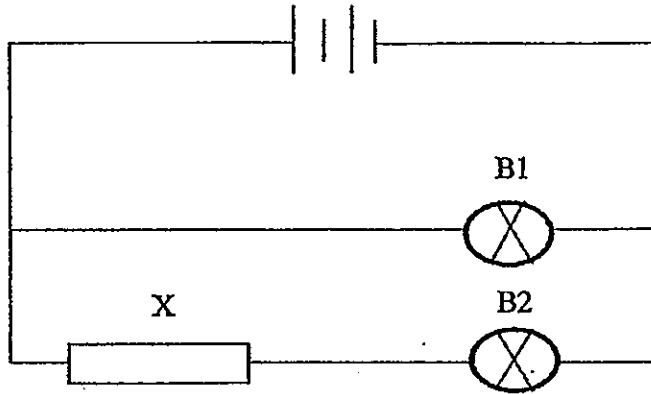

B1 and B2 were switched position as shown below. Again , B1 lighted up but B2 did not.

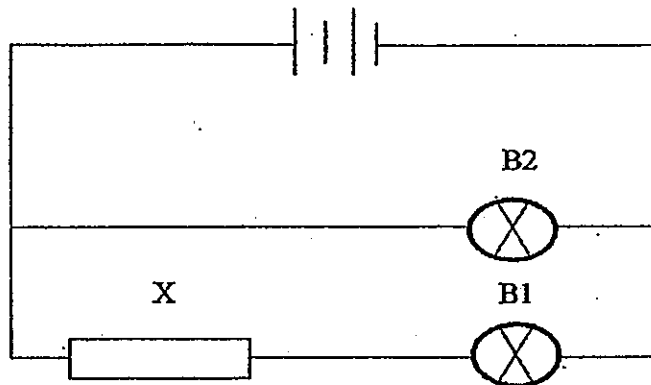

From the observation, what could be a possible reason why B2 did not light up?

- (1) The filament in B2 has melted.
- (2) X is a non-conductor of electricity.
- (3) The batteries are connected wrongly.
- (4) The bulbs are in parallel arrangement.

28 The diagram below showed how a spring was extended.

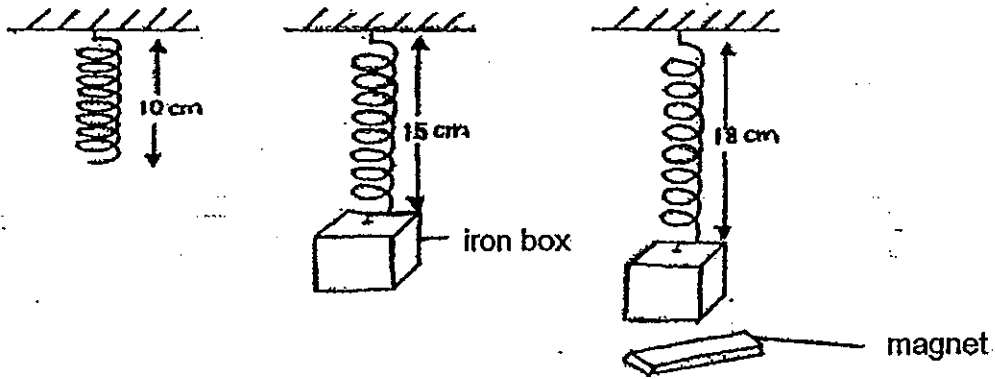

Which force caused the spring above to extend from 15cm to 18cm?

- (1) Friction
- (2) Gravitational
- (3) Magnetic
- (4) Elastic Spring

29 The flow chart below is used to classify forces A, B and C.

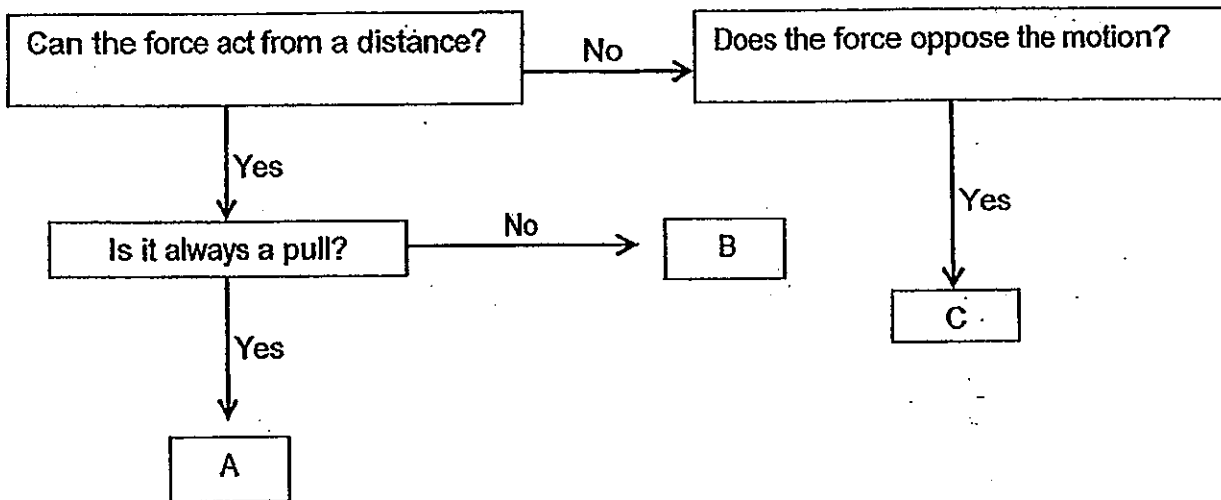

In which one of the followings all the 3 forces are identified correctly?

	A	B	C
(1)	Gravitational	Magnetic	Frictional
(2)	Magnetic	Gravitational	Frictional
(3)	Gravitational	Frictional	Magnetic
(4)	Frictional	Magnetic	Gravitational

30 Darren carried out an experiment and concluded that as the mass of the weights increases the length of spring increases. The spring he used in his experiment can extend to its maximum when a weight of 600g is hung on it. He recorded the results in the table below.

Mass (g)	Length of spring (cm)
0	10
200	20
400	?

What will the length of the spring be when a 400g weight is hung on it?

- (1) 15cm
- (2) 20cm
- (3) 30cm
- (4) 40cm

End of Part 1



Rosyth School
Second Semestral Examination for 2013
SCIENCE
Primary 5

Name: _____

Total
Marks:

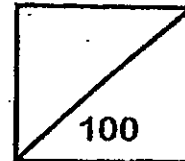

Class: Pr 5 - _____ Register No. _____ Duration: 1 h 45 min

Date: 28 October 2013 Parent's Signature: _____

Booklet B

Instructions to Pupils:

1. For questions 31 to 44, write your answers in the spaces given in this booklet.

	Maximum	Marks Obtained
Booklet A	60 marks	
Booklet B	40 marks	
Total	100 marks	

* This booklet consists of 13 pages.

This paper is not to be reproduced in part or whole without the permission of the Principal.

- 31 Jane placed equal number of single-celled organisms into 2 petri dishes, labelled, S and R. She left S in a dark cupboard and R in a bright cupboard. She monitored the number of living organisms in both petri dishes over a few days and represented in a graph as shown below.

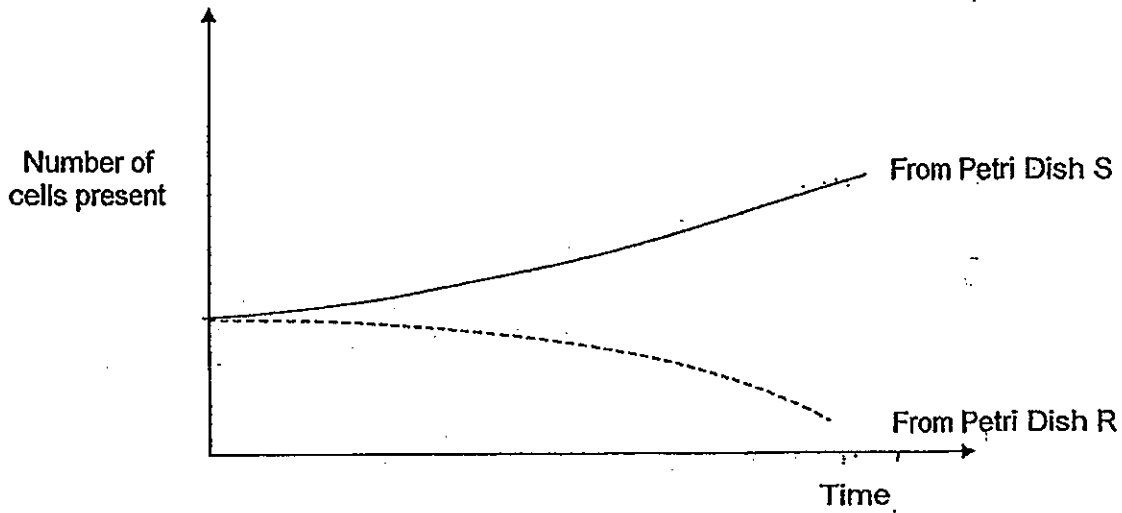

- (a) What was the aim of Jane's experiment?

[1]

- (b) Jane concluded that light is not needed for the organisms to survive. Explain why.

[1]

- 32 Joseph examined two plant cells under a microscope. Both cells were taken from the same plant and he labelled them Cell A and Cell B.

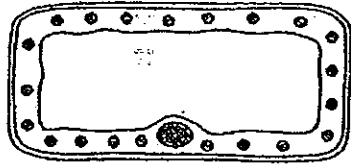

Cell A

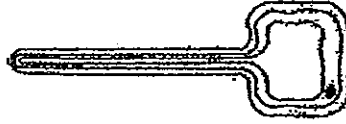

Cell B

- (a) Which cell is taken from the leaf? Explain your choice. [1]

- (b) Why are the cells different in shape? [1]

- (c) State 2 reasons why cells A and B carry out cell division. [2]

33 The diagram below shows the head of a fish.

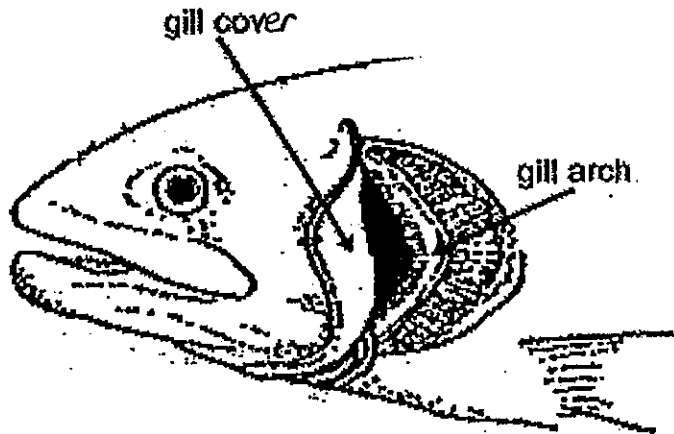

(a) Draw arrows on the diagram above to show the flow of water when a fish takes in oxygen and gives out carbon dioxide. [1]

(b) Complete the table to show the parts of the body involved in gaseous exchange. [2]

	Fish	Human
Part involved in gaseous exchange		

34 The graph below shows Steven's pulse rate over a period of one hour.

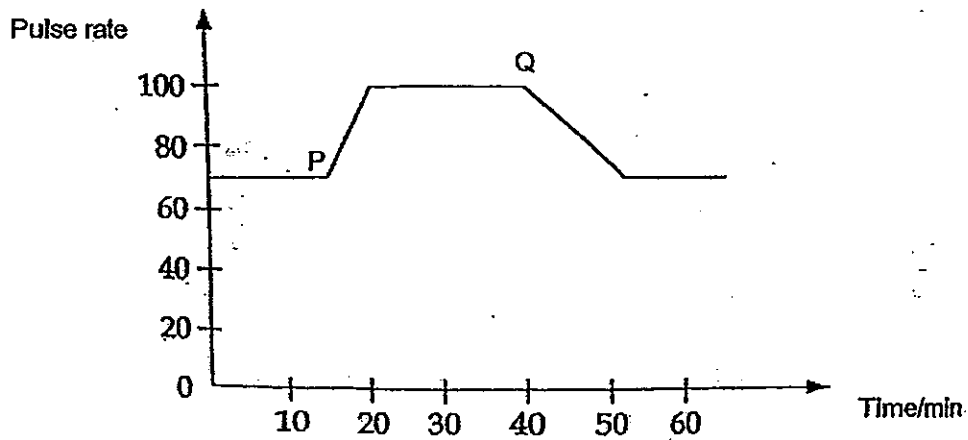

(a) What is Steven's pulse rate when he is at rest? [1]

(b) Steven started to jog at Point P. Explain why the pulse rate increases after that. [2]

- 35 Devi investigated the light intensity and the number of plants in a pond. She drew the two graphs below to provide information about her findings.

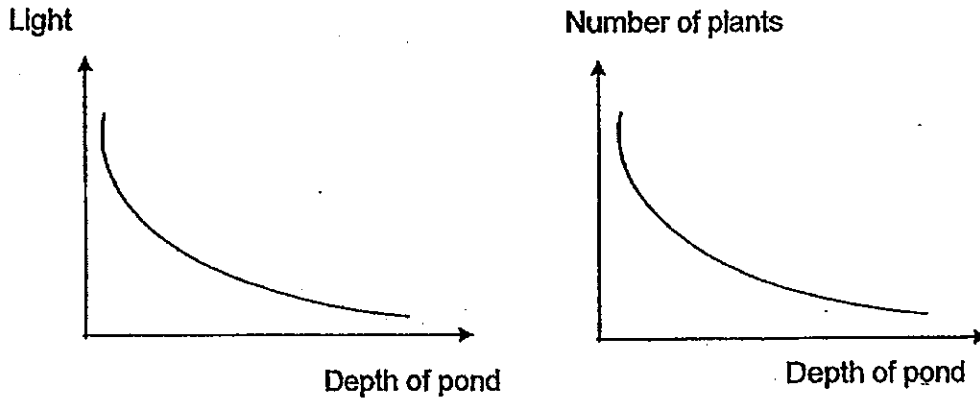

Graph A shows how light intensity is affected by the depth of the pond while Graph B shows how the number of plants is affected by the depth of the pond.

- (a) Based on the graphs above, what is the relationship between the light intensity in the pond and the number of plants found? [1]

- (b) Predict the relationship between the number of plants in the pond and the number of animals in the pond. [1]

- (c) State 2 reasons why the animals are dependent on the plants in the ponds. [1]

- 36 Susan investigated the effect of two chemicals, Y and Z, on the growth of duckweeds. She had three set-ups for her experiment. The results were shown in the graph below.

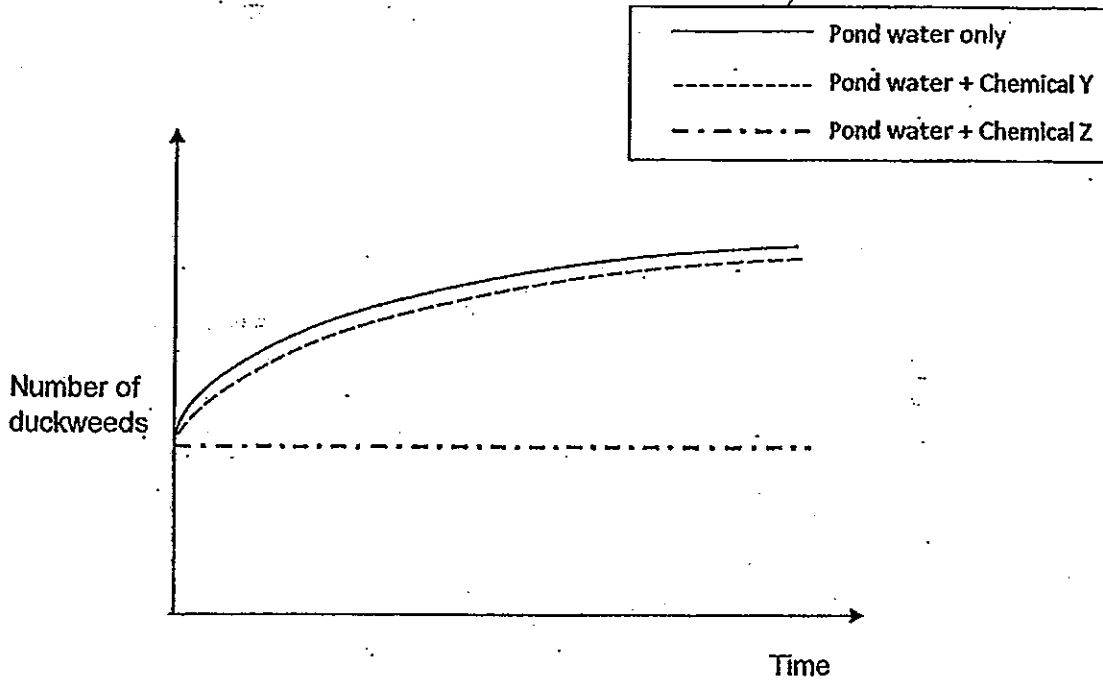

- (a) Which chemical was not suitable for the growth of duckweeds?
Give a reason for your choice.

[1]

- (b) Which is the experimental control set-up? What is the purpose of it? [2]

37 Read the following description of five organisms, C, D, E, F and G living in the same habitat.

- Both F and G feed on E.
- C is a prey of D and a predator of G.
- C is the only omnivore.

(a) Use the information above to complete the food web below.
Write the letters C, D, E, F and G in the correct circles.

[2]

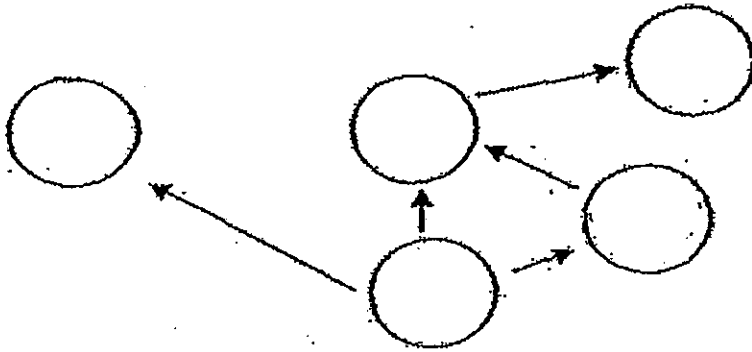

(b) Name the food producer (C, D, E, F or G) in the food web above.

[1]

(c) Use the above food web to form a food chain which has 3 consumers. [1]

38 Study the food chain below.

Plant → Organism P → Ladybird → Organism Q → Bird

(a) State what would happen to populations P and Q when there were fewer ladybirds in the habitat and there was no change in the populations of Plant and Bird. Give reasons for your answer. [2]

Organism P:

Organism Q:

(b) Farmer Jo realised that his plants were being eaten by Organism P. Suggest a way that he can remove the Organism P without spraying insecticide on his plantation. [1]

39 Andy recorded the following information about a koala.

The koala lives in eucalyptus trees. It has a dense woolly coat which protects it from hot and cold conditions. It gives birth and carries its baby in its pouch. The paws of the koala are heavily padded and it has long sharp claws. It is an herbivore and eats eucalyptus leaves. It is not really bothered by predators.

(a) Why do you think the koala bear has long sharp claws? [1]

(b) Do you think koala is a mammal? Support your choice. [1]

- 40 Four different types of plants, A, B, C and D, were planted as indicated in the diagram below. The arrow indicates the direction of flow of the river.

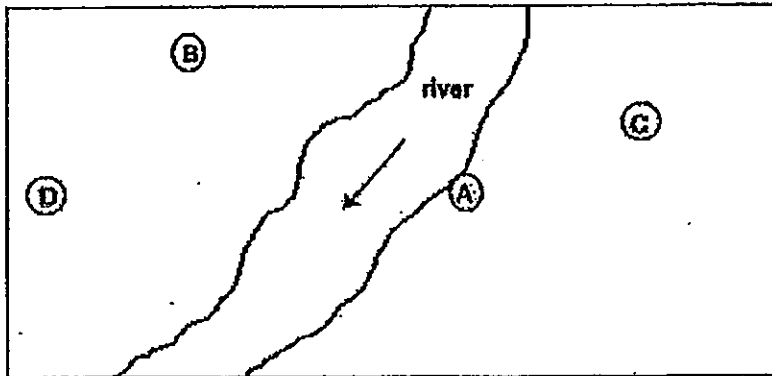

A few years later, the same area was studied, and the locations of the 4 different plants were identified and indicated in the diagram below.

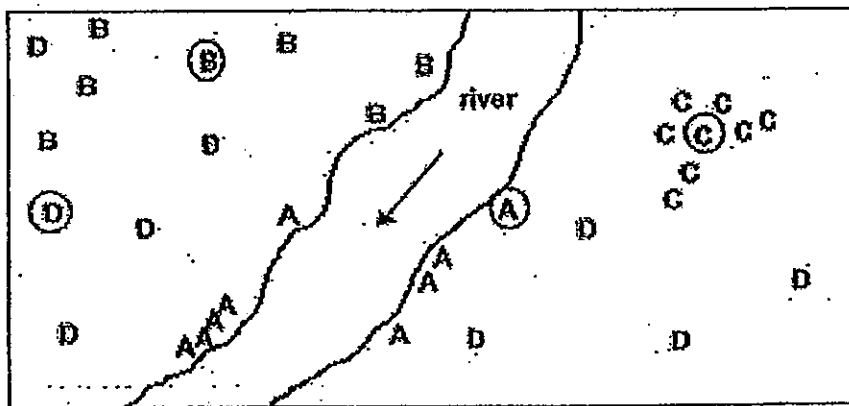

- (a) Based on the diagram above, state the method of seed dispersal for the following plants: [2]

(i) Plant A: _____ (ii) Plant D: _____

The seeds of Plant B are dispersed by animals.

- (b) What structural adaptation does the fruit of Plant B have in order to be dispersed by an animal? [1]

- (c) Give an example of Plant C. [1]

41. The circuit diagrams, A and B, below show 3 identical bulbs, X, Y and Z, arranged in 2 different ways.

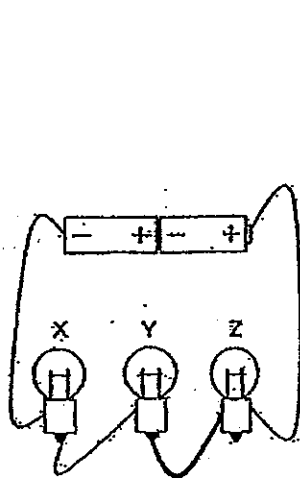

Circuit A

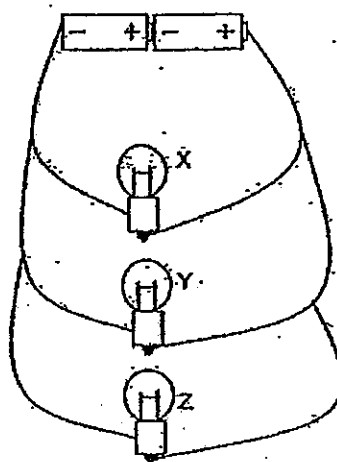

Circuit B

Describe what would happen to bulbs X and Z when bulb Y in both circuits is fused. [2]

(i) Circuit A:

(ii) Circuit B:

- 42 Nelly wanted to find out if the number of batteries affects the brightness of a bulb. The graph below shows the results of her experiment.

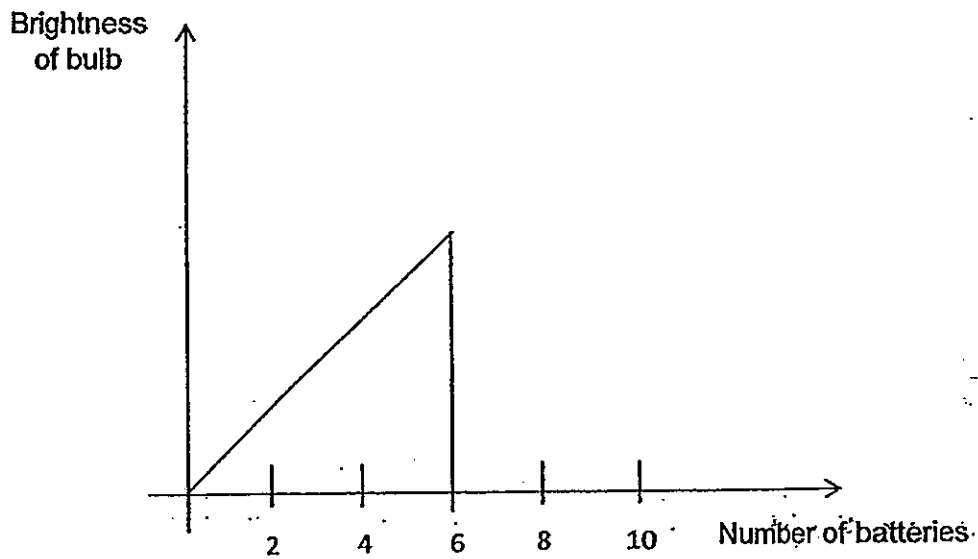

- (a) Describe the brightness of the bulb as the number of batteries increased from 1 battery to 5-batteries. [1]

- (b) Why did the bulb fuse when the 6th battery was added? [1]

- 43 When a boy threw a toy parachute from the top of the roof, within seconds, it fell to the ground.

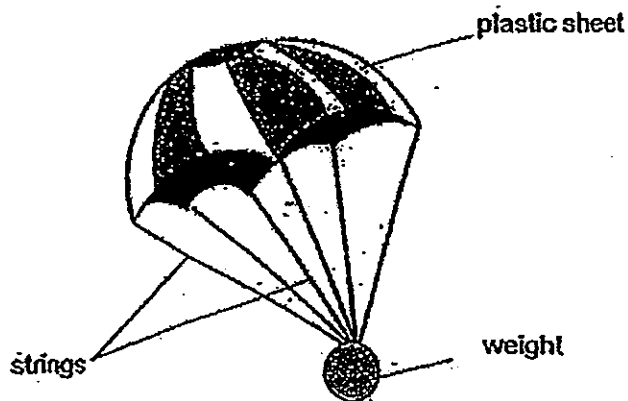

- (a) Name the force that caused the above observation. [1]

- (b) How can we keep the parachute in the air for a longer time? [1]

- 44 An experiment was carried out to find how the type of surface affects the amount of pulling force. The force needed to pull the block across each surface was measured and recorded.

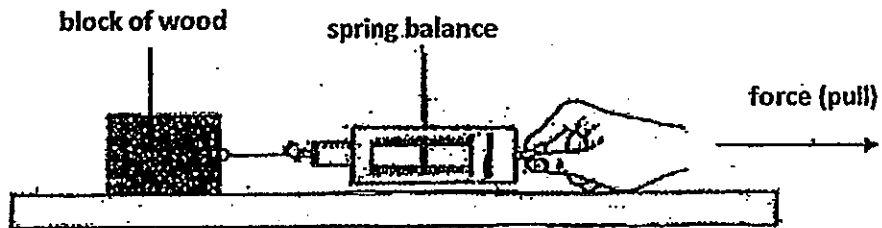

The results were shown in the table below.

Surface	Force needed to move the block (N)
Rough	21
Smooth	12

- (a) What is the conclusion of the experiment above? [1]

- (b) What force(s) is/are the pulling force overcoming in the above set-up? [1]

- (c) What would happen to the pulling force if the mass of the block is greater? Explain why. [1]

End of Paper

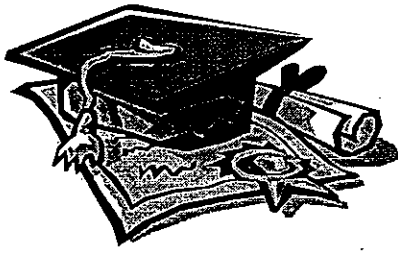

ANSWER SHEET

EXAM PAPER 2013

SCHOOL : ROSYTH

SUBJECT : PRIMARY 5 SCIENCE

TERM : SA2

Q1	Q2	Q3	Q4	Q5	Q6	Q7	Q8	Q9	Q10	Q11	Q12	Q13	Q14	Q15	Q16	Q17
4	2	2	4	3	1	4	3	4	2	4	4	3	1	2	3	4

Q18	Q19	Q20	Q21	Q22	Q23	Q24	Q25	Q26	Q27	Q28	Q29	Q30
2	4	2	4	1	3	2	4	2	1	3	1	3

31)a)The aim is to find out if the single-celled lives better in the dark cupboard than to the bright cardboard.

b)There are more cells left in the dark cupboard.

32)a)Cell A was taken from the leaf as it has chloroplast that is needed to make food.

b)It is because they have different function.

c)To repair damaged cells and for growth of the plant.

33)a)

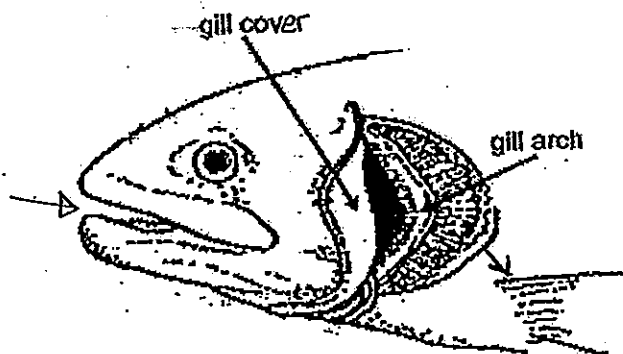

b)gills

lungs

34)a) His pulse rate is 70 when he is at rest.
b) H increases to supply more oxygen and more energy to the body.

35)a) The more intensity is the light the more the number of plant in the pond.
b) As the number of plant decrease the number of animal decrease.
c) The animal depend on food and oxygen from the plant.

36)a) The number of duckweed remain the same.
b) Pond water only is the control set-up. The purpose of a control set-up to ensure the experiment is a fair test.

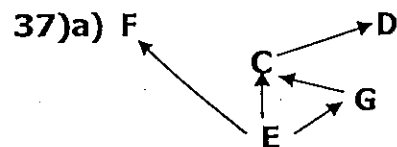

b) E is the food producer.
c) $E \rightarrow G \rightarrow C \rightarrow D$

38)a) P: There will be more organism. The ladybird is a predator to organism P therefore if there is lesser ladybird there will be lesser predator to organism P.

Q: Organism Q decreases as there is less food.

b) Release more ladybird to eat organism P.

39)a) To climb eucalyptus tree without falling.
b) I think koala is a mammal. Koala give birth to young and has two legs.

40)a) i) water dispersal ii) wind dispersal
b) Large and hard seed.
c) Rubber is an example of plant C.

41)i) All the bulbs in circuit A will not work.
ii) X and Z in circuit B will work.

42)a) The brightness of the bulb increased.
b) The filament got hot and melted.

43)a) Gravitational force.
b) Increase the size of the plastic/decrease the weight.

44)a) The Rougher the surface, is the more the force needed to move the block.
b) Frictional force and elastic spring force.
c) We would need more force to pull the block. The more the mass the more force needed to.