



RAFFLES GIRLS' PRIMARY
SCHOOL

SEMESTRAL ASSESSMENT (2)
2013

Name : _____ Index No: _____ Class: P 5 _____

Section A	50
Section B	40
Your score out of 90	90
Parent's signature	

21 October 2013 **SCIENCE** Attn: 1 h 30 min

SECTION A (25 X 2 marks)

For each question from 1 to 25, four options are given. One of them is the correct answer. Make your choice (1, 2, 3 or 4). Shade the correct oval on the Optical Answer Sheet.

1. The diagram below shows the reproductive systems of a flower and woman.

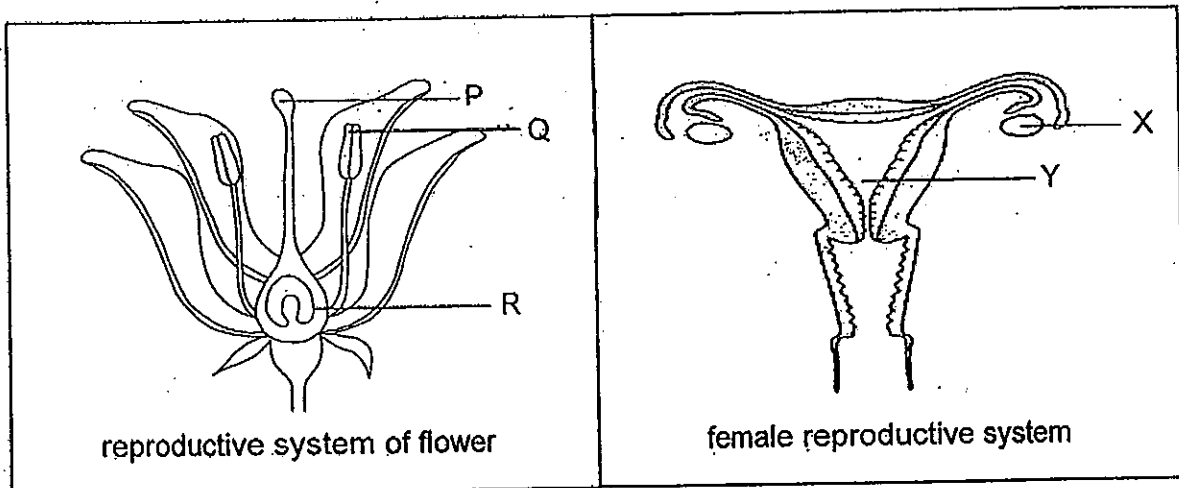

Which one of the following statements about the above reproductive parts is true?

- (1) P and X store sex cells.
- (2) Q and Y have similar function.
- (3) After fertilisation, R will develop into a fruit while the fertilised egg will develop into a baby in Y.
- (4) P, Q and R are female reproductive parts of plants and X and Y are female reproductive parts of humans.

2. Which of the following can be inherited from your parents?

- A dimples
- B hair length
- C widow's peak
- D colour of the eyes

- (1) A only
- (2) B and C only
- (3) A, C and D only
- (4) A, B, C and D

3. Karen placed seeds in 4 containers of the same size in set-ups A, B, C and D, in a room with a temperature of 28°C. The 4 set-ups were exposed to different conditions as shown in the diagrams below.

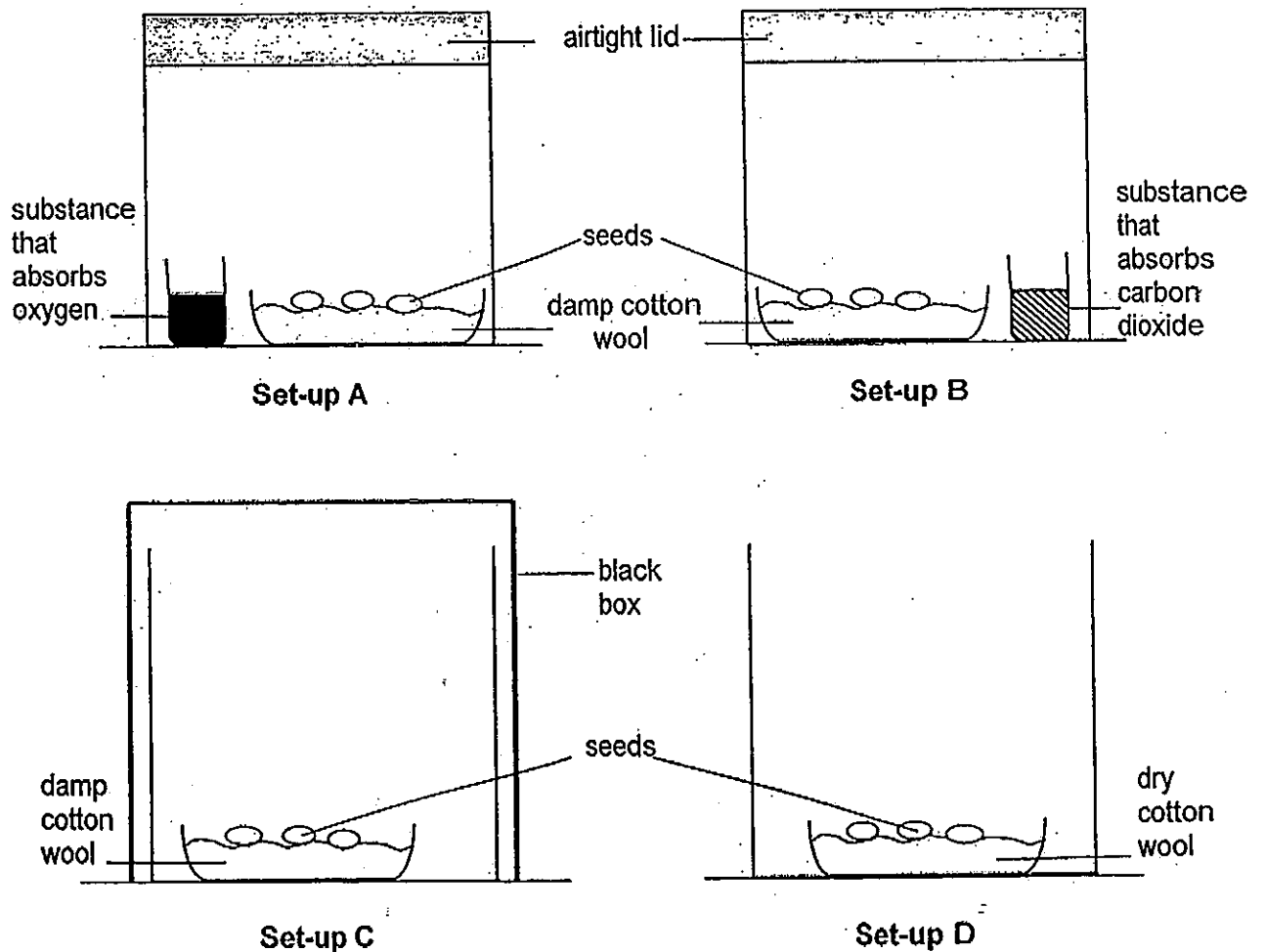

In which of the above set-ups would the seeds most likely to germinate?

- (1) A and C only
- (2) B and C only
- (3) A and D only
- (4) B and D only

4. Ming Hui conducted an experiment to find out which parts of flower X shown below were necessary to form a fruit. He removed two parts of flower X.

He then transferred some pollen grains from another flower of the same plant to the remaining parts of flower X.

After a period of time, flower X developed into a fruit.

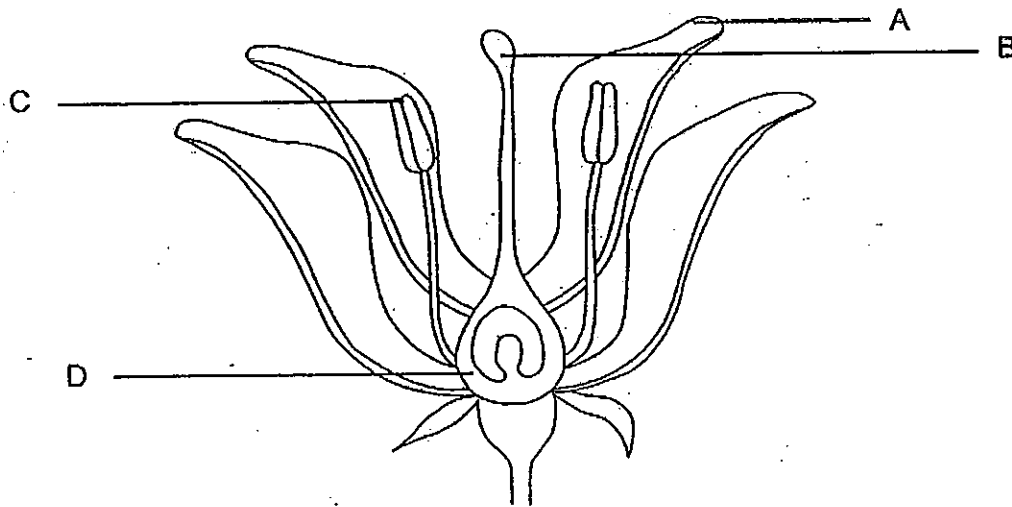

Flower X

Which two parts of flower X had been removed by Ming Hui?

- | | |
|-------------|-------------|
| (1) A and C | (2) B and C |
| (3) A and D | (4) C and D |

5. Priya wanted to find out if Plant X needed light to survive. She set up the following experiment as shown in the diagram below.

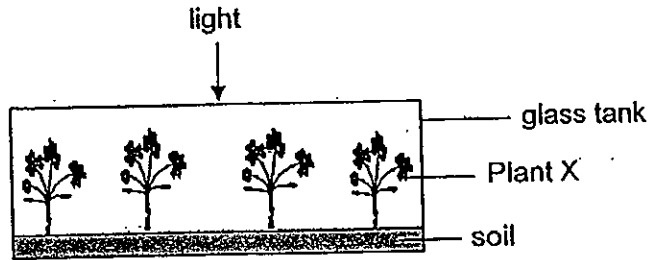

Which of the following should she choose as a control set-up for her experiment?

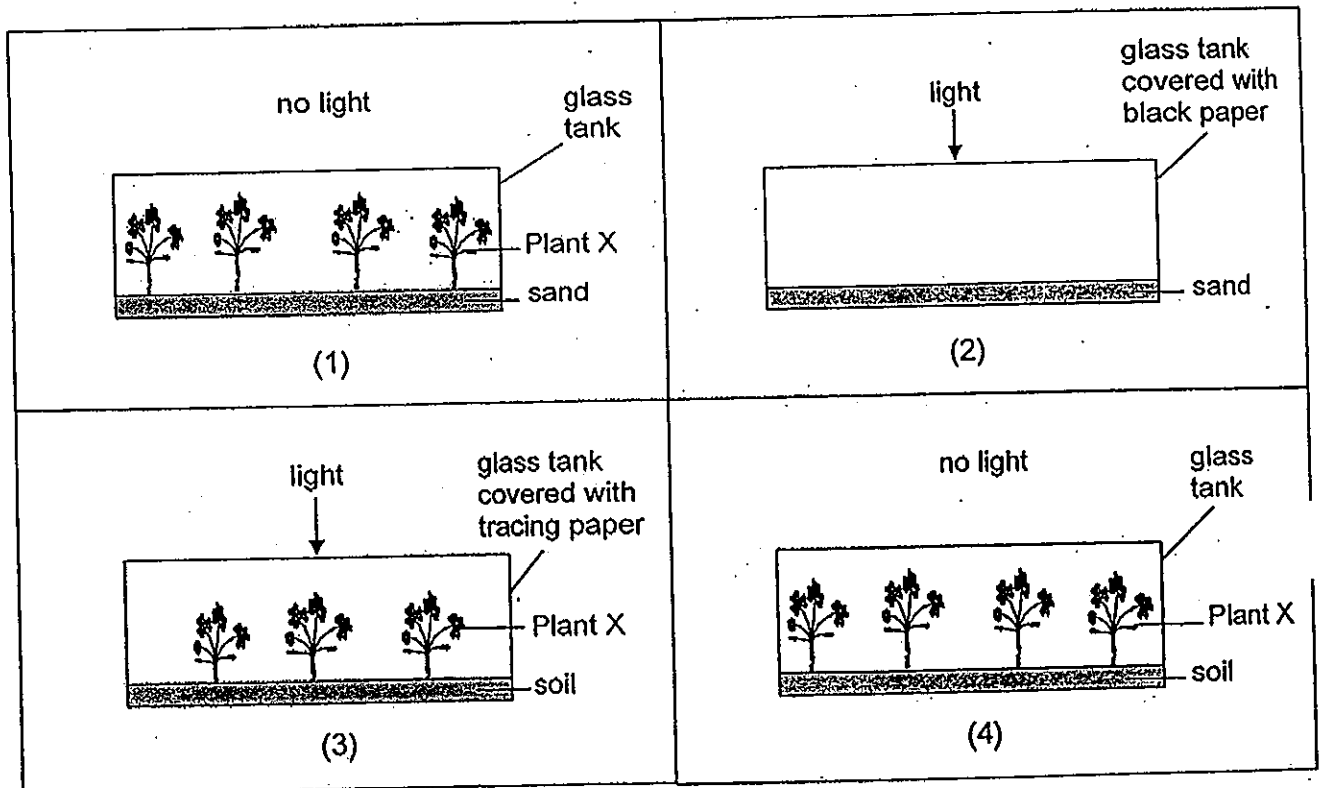

6. The diagram below shows the human digestive system.

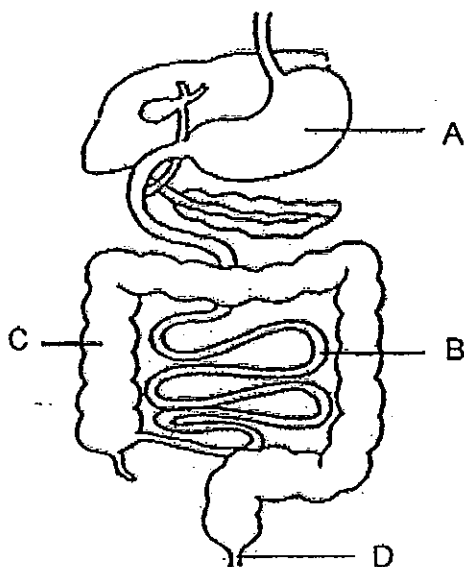

In which part of the digestive system above does digestion end?

- (1) A
- (3) C

- (2) B
- (4) D

7. Khalid prepared a model of the respiratory system as shown in diagram X below. Diagram Y shows parts of the human respiratory system.

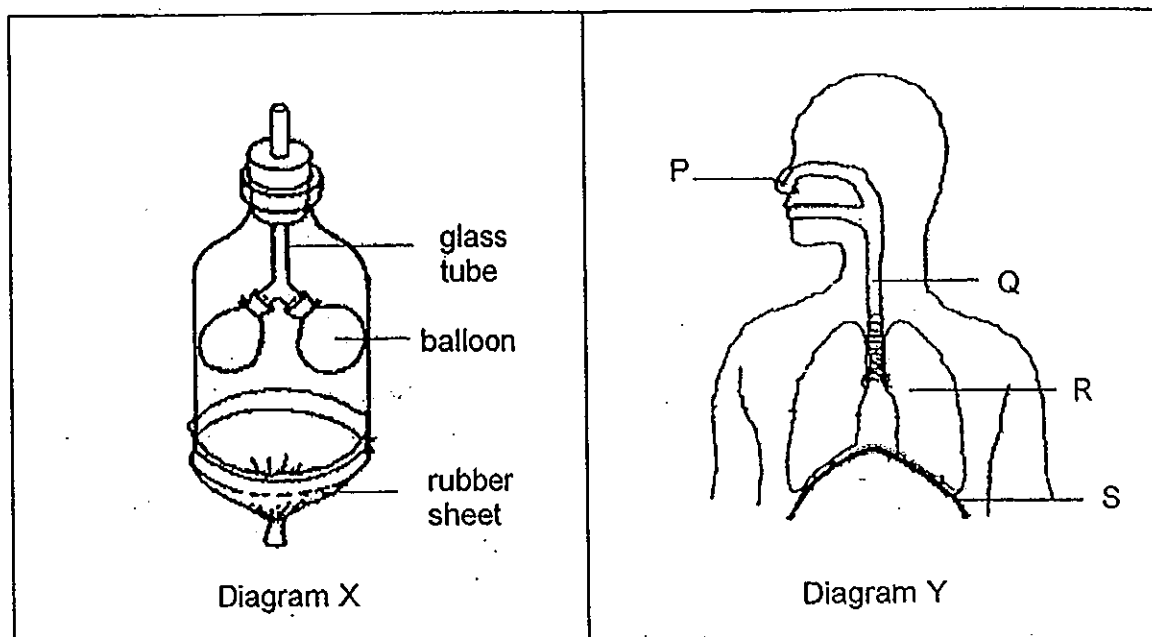

Which of the following shows the correct representation of the parts of the human respiratory system by the glass tube, balloon and rubber sheet respectively?

	Glass tube	Balloon	Rubber sheet
(1)	Q	R	S
(2)	P	R	S
(3)	P	Q	R
(4)	Q	S	R

8. David prepared a set-up as shown in the diagram below. He poured solution P into a plastic bag and fastened it to prevent the solution from spilling.

Then he placed it into a beaker which contained solution Q.

He observed that solution P changed colour but not solution Q.

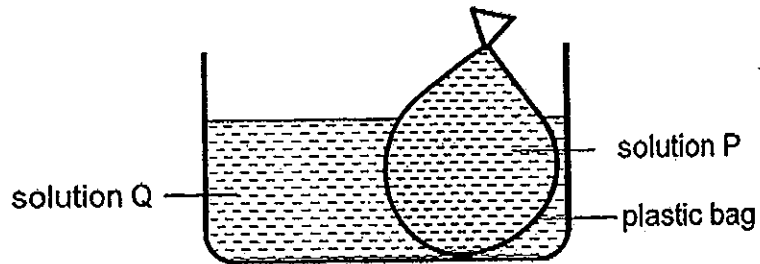

Based on his observation, which part of the plant cell has a similar function as the plastic bag shown above?

- | | |
|-------------------|------------------|
| (1) cell wall | (2) chloroplasts |
| (3) cell membrane | (4) cytoplasm |

9. Tom placed two rats in a sealed container. Which of the following most likely shows the changes in the composition of the air inside the container after two hours?

	Carbon dioxide	Oxygen	Water Vapour
(1)	Decreased	Increased	Increased
(2)	Decreased	Increased	Remain unchanged
(3)	Increased	Decreased	Increased
(4)	Increased	Decreased	Remain unchanged

10. Jane placed fish of the same species into three containers, A, B and C, each filled with an equal amount of water.

Container A is sealed but not containers B and C. The three containers were placed near the window.

She then measured the amount of time taken for all the fish to start swimming near the surface of the water.

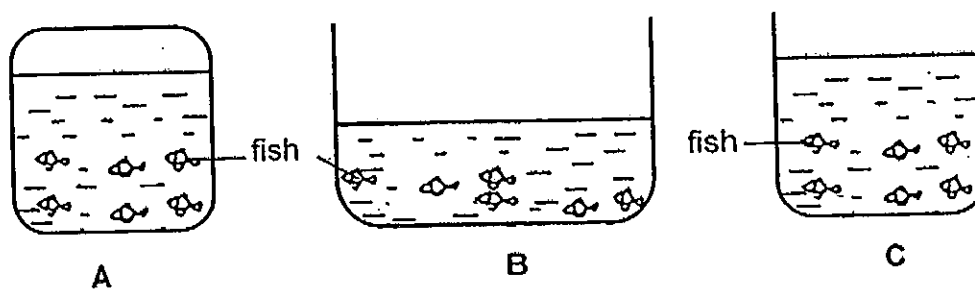

Which one of the following could possibly be the time taken for the fish in each container to start swimming near the surface of the water?

	A	B	C
(1)	10 minutes	20 minutes	15 minutes
(2)	10 minutes	15 minutes	20 minutes
(3)	15 minutes	15 minutes	15 minutes
(4)	15 minutes	20 minutes	20 minutes

11. May placed four set-ups, A, B, C and D, in the garden to find out how the presence of light affects the amount of oxygen in each set-up.

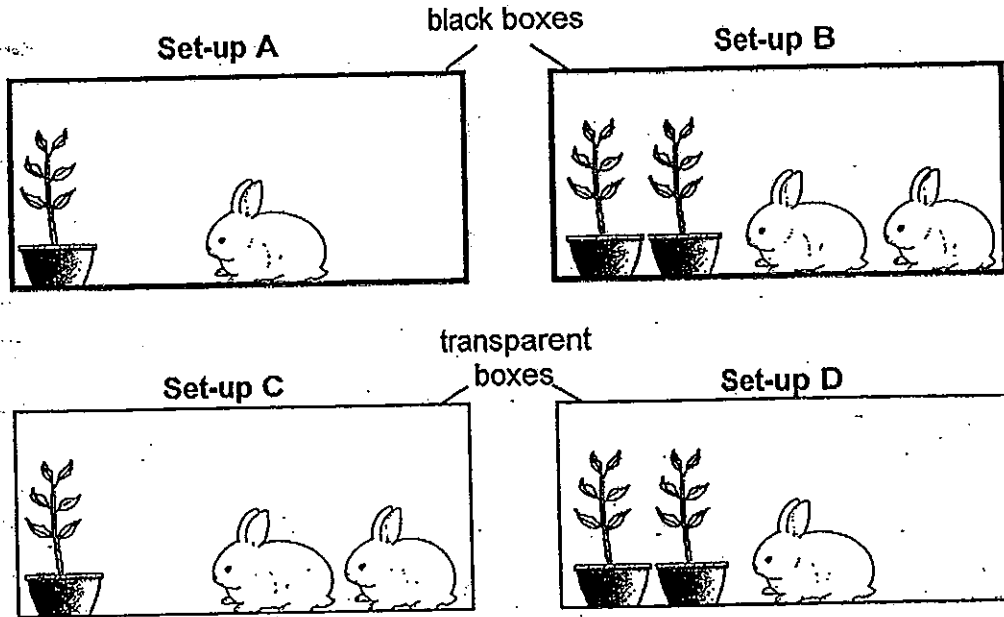

Based on the information above, arrange the above set-ups in increasing order of the amount of oxygen recorded after an hour, starting from the least to the greatest amount of oxygen.

	Least amount of oxygen → Greatest amount of oxygen			
(1)	D	C	A	B
(2)	B	D	A	C
(3)	A	C	B	D
(4)	B	A	C	D

12. The table below shows the characteristics of four different fruits W, X, Y and Z.

Fruits	W	X	Y	Z
Size	Small	Small	Big	Big
Weight	Light	Light	Light	Light
Special characteristics	Feathery and hair-like	Sharp Hooks	Hard outer covering with fibrous husk	Fruit walls that dry up and explode when fruit is ripe

Which of the following show the correct methods by which the fruits W, X, Y and Z are dispersed?

	W	X	Y	Z
(1)	By water	By animal	By splitting	By wind
(2)	By wind	By water	By animal	By splitting
(3)	By splitting	By animal	By water	By wind
(4)	By wind	By animal	By water	By splitting

13. The table below shows a comparison between the plant and human transport systems.

Which one of the following comparison is correct?

	Plant transport system	Human transport system
(1)	Has only food-carrying tubes to transport substances	Has only blood vessels to transport substances
(2)	Needs leaves and roots to pump food and water to all parts of the plants	Needs heart to pump oxygen to all parts of the body
(3)	Transports food that is made by the leaves	Transports food that has been digested
(4)	Transports only water by the stem	Transports only food, water and carbon dioxide

14. John placed three plants of the same species in identical beakers, each containing an equal amount of water as shown in the diagram below. He then placed set-ups A, B and C near a window for a day.

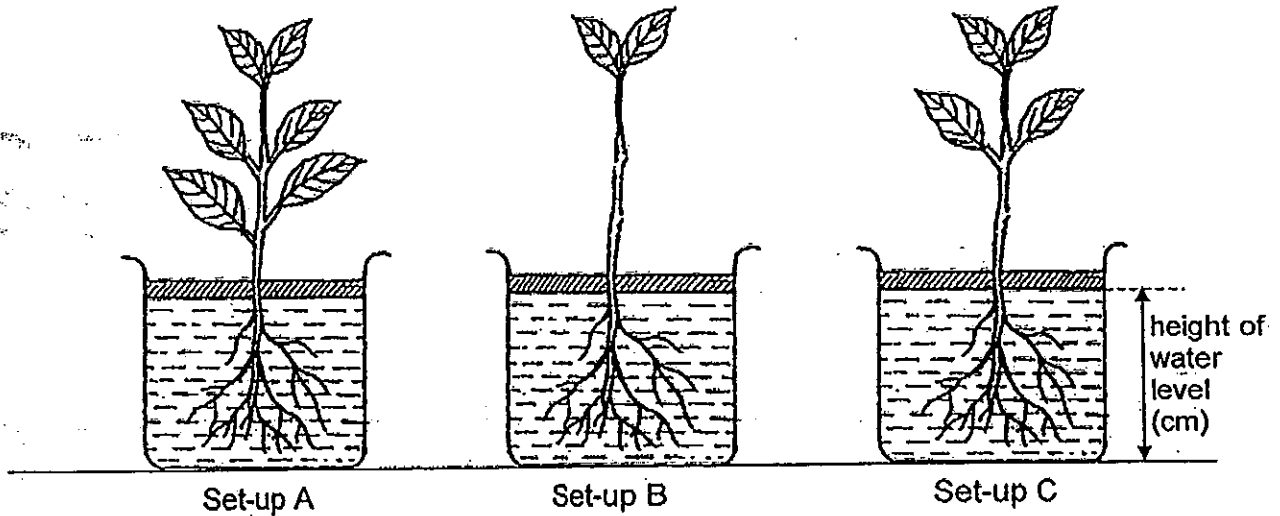

At the end of the experiment, John recorded the height of water level in each beaker.

Which one of the following graphs below shows the correct height of water level in set-ups A, B and C at the end of the experiment?

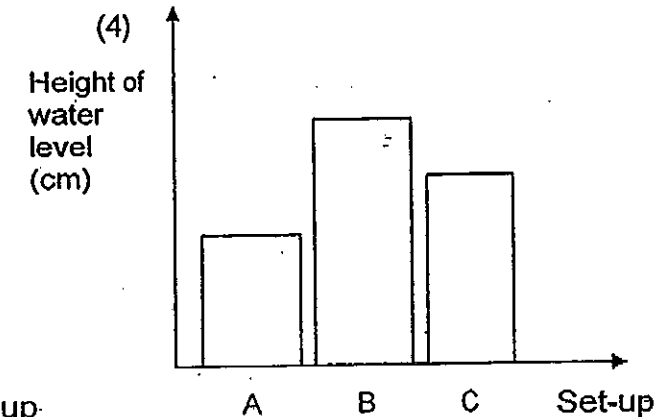
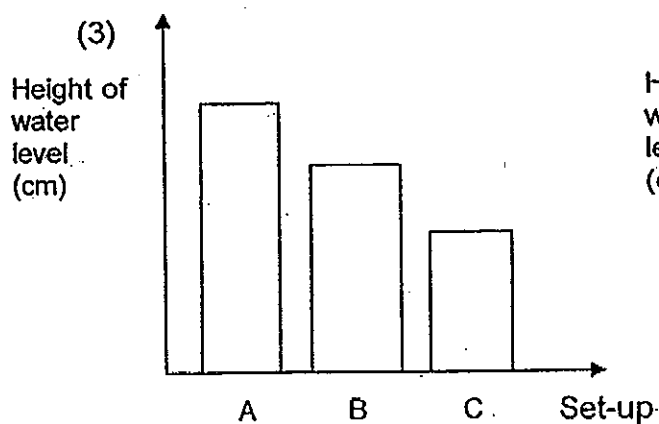
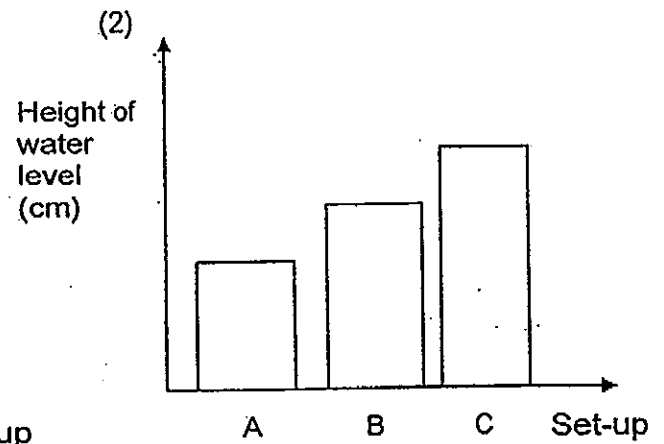
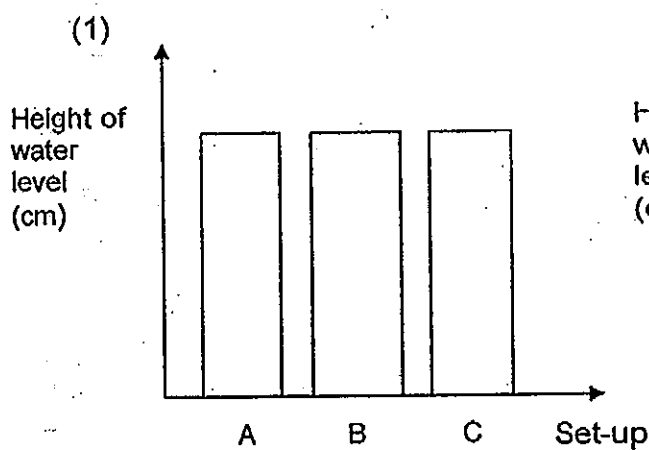

15. Caren prepared a set-up which consisted of a 500-ml beaker filled completely with ice cubes. The graph below shows the change in temperature of the beaker of ice cubes, placed in a room with a temperature of 30 °C, over time.

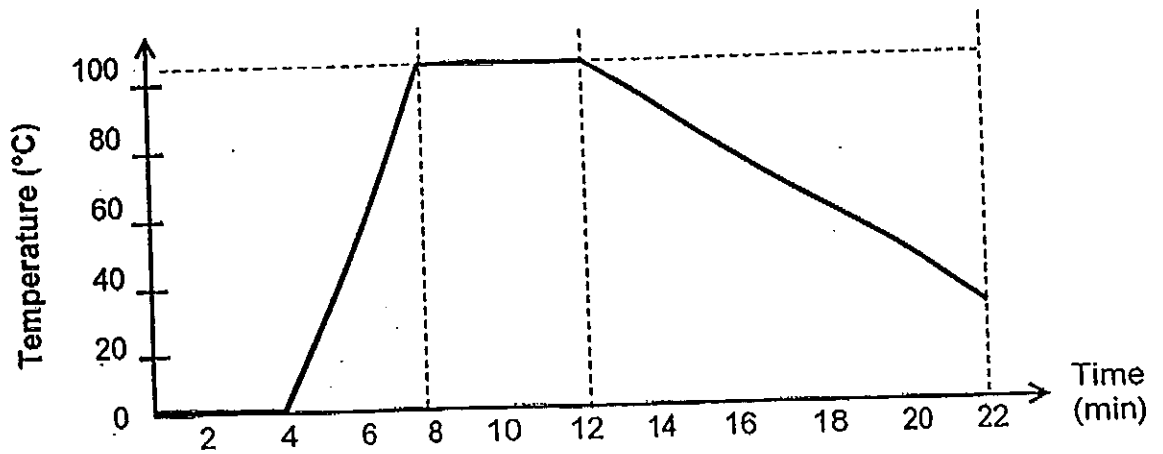

Based on the graph above, what could Caren possibly have done to her set-up at 4th minute and 12th minute respectively?

	4 th minute	12 th minute
(1)	A heat source was added	The heat source was removed
(2)	A heat source was added	Two ice cubes were added into the beaker
(3)	Tap water was added into the beaker	Two ice cubes were added into the beaker
(4)	Tap water was added into the beaker	A heat source was added.

16. Mr Chan placed his son's wet shoes, shown in the diagram below, in his garden to dry.

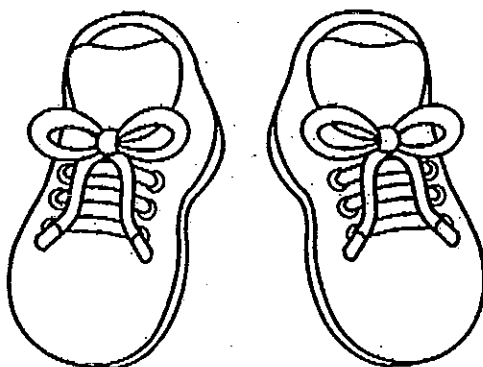

Which one of the following graphs shows how the mass of the wet shoes, placed outside the house, changed with time?

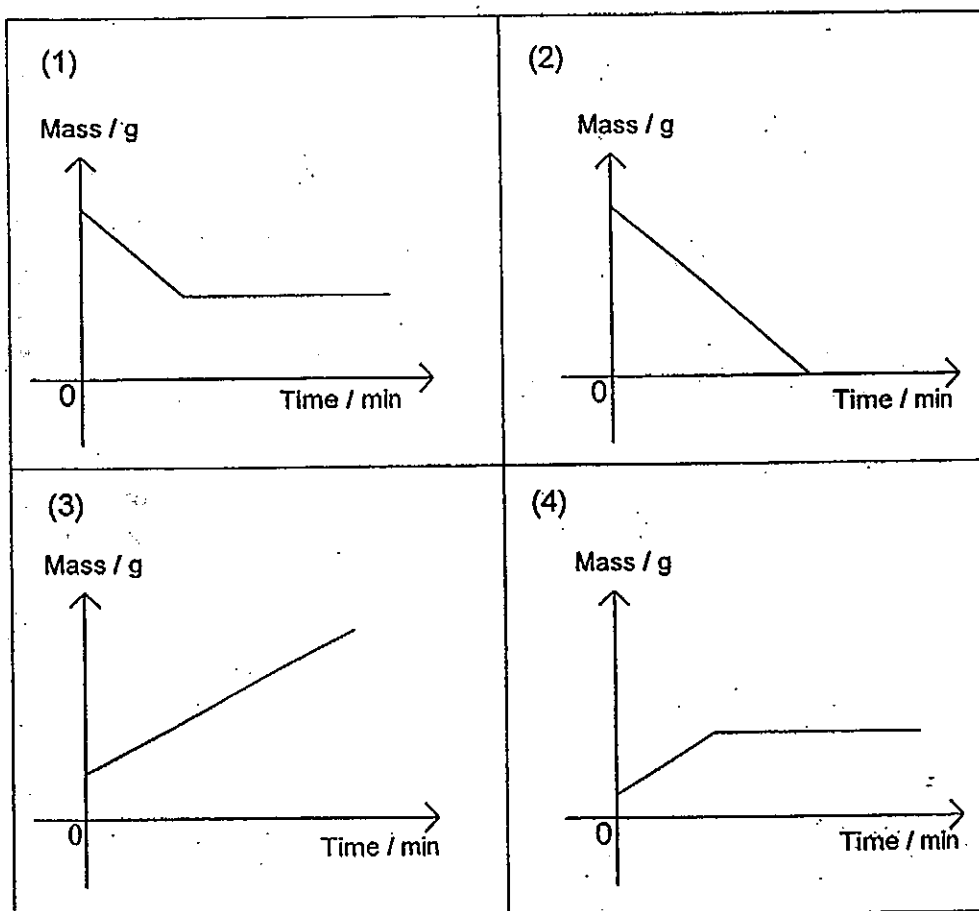

17. A dentist checks John's teeth using the lamp as shown below.



Which one of the following sets of arrows correctly shows the path of light?

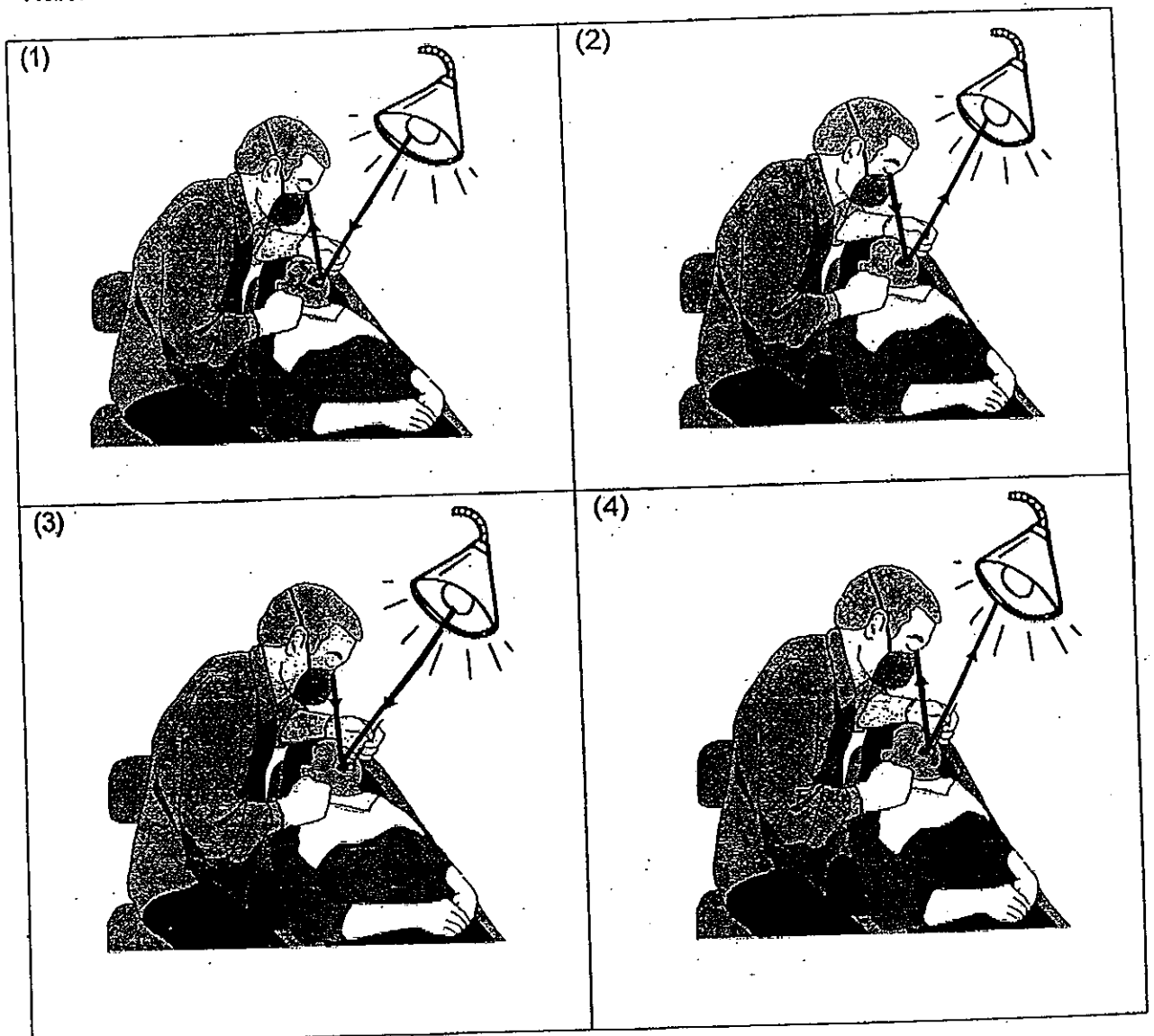

18. A torch, a ball and a screen are placed on the table with markings labeled A to F as shown in the diagram below. When the torch is switched on, a shadow is cast on the screen.

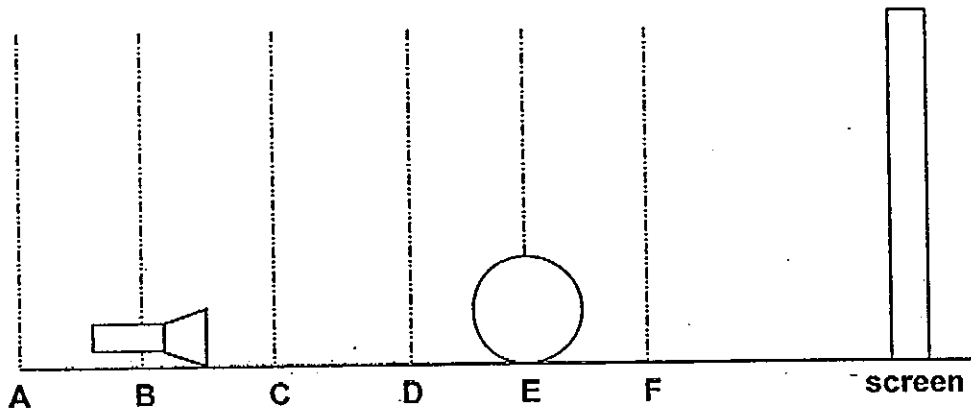

Which of the following shows the position of the torch and ball such that the smallest shadow will be cast on the screen?

	Position of torch	Position of ball
(1)	A	E
(2)	D	E
(3)	B	D
(4)	C	F

19. Ali had a metal ring which is stuck around the metal rod as shown below.

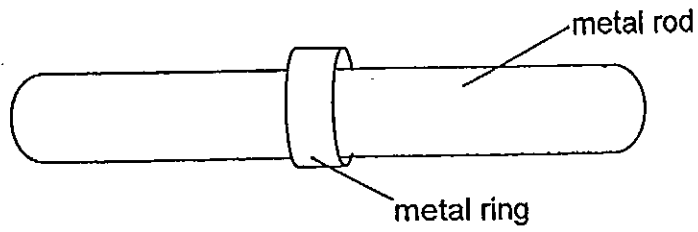

Which one of the following methods, shown in the diagrams, should Ali choose to help him to remove the metal ring from the metal rod most effectively?

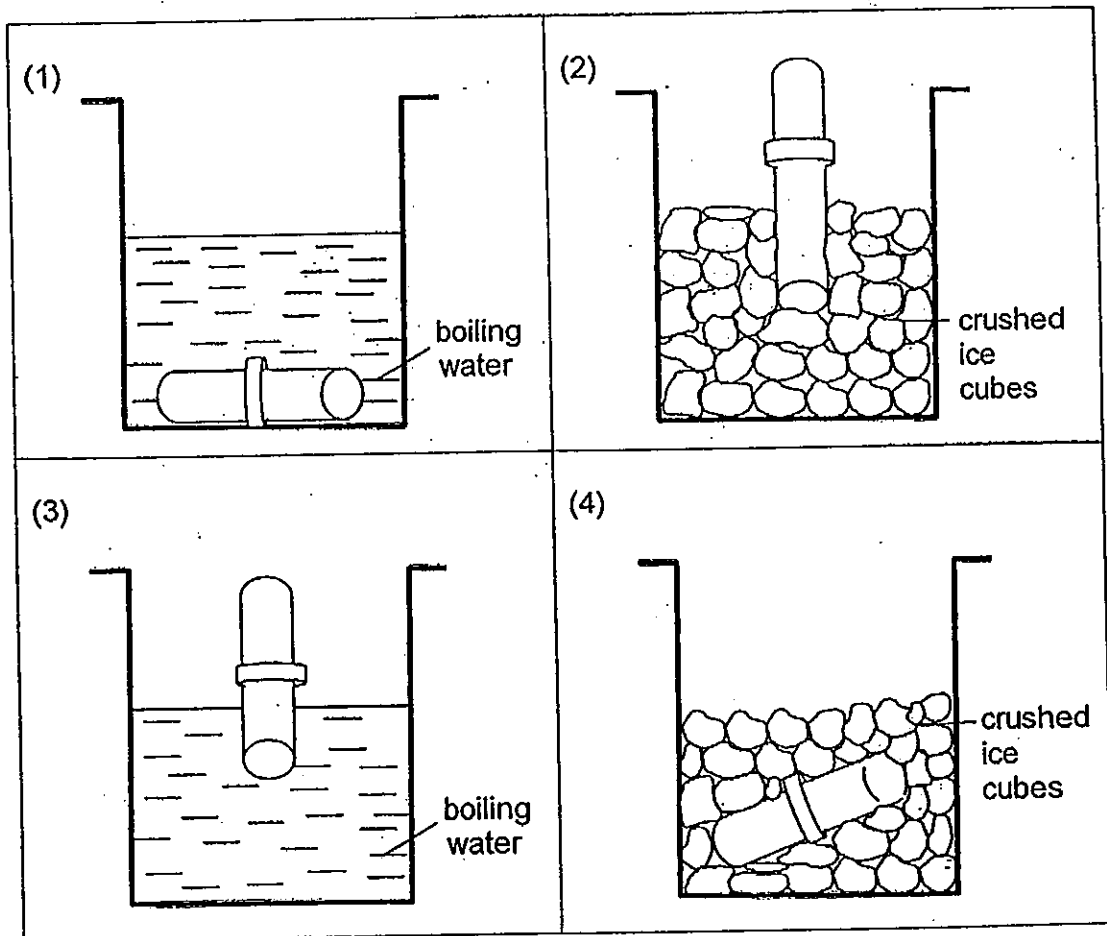

20. Two bars, X and Y, of the same size and thickness were wrapped tightly with paper of the same size and thickness as shown below.

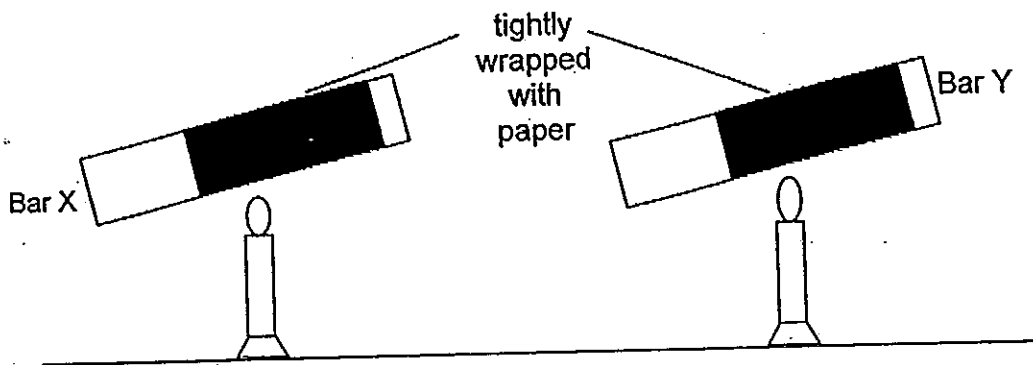

Each bar was heated over a flame for 15 minutes. After 15 minutes, Kelly noticed that the paper on bar Y was burnt but not the paper on bar X.

Which of the following statements explain Kelly's observations correctly?

- A X is a better conductor of heat as it conducted heat away from the paper to the surrounding air more quickly.
- B X is a poorer conductor of heat as it conducted heat away from the paper to the surrounding air more slowly.
- C Y is a better conductor of heat as it conducted heat from the flame to the paper more quickly.
- D Y is a poorer conductor of heat as it conducted heat away from the paper more slowly.

- (1) A and C only
- (3) A and D only

- (2) B and C only
- (4) B and D only

21. Identical batteries, bulbs and wires are used to set up four circuits, S, T, U and V, as shown below.

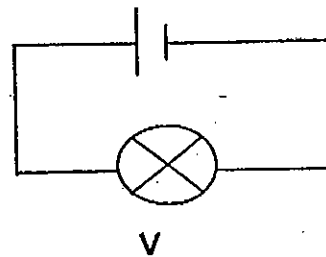
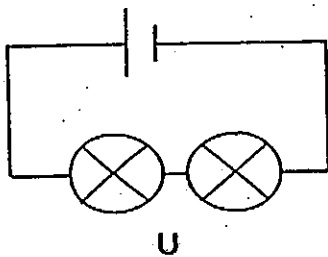
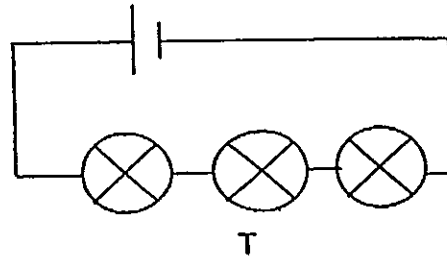
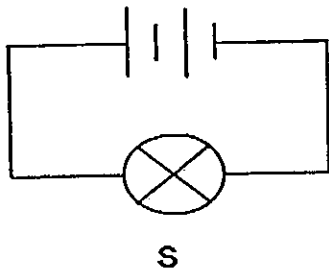

Which one of the following shows the correct arrangement of the bulbs in increasing order of brightness starting from the least bright to the brightest?

	Least bright Brightest			
	—————→			
(1)	T	U	V	S
(2)	T	S	V	U
(3)	V	S	U	T
(4)	V	U	S	T

22. The diagram below shows four different circuit arrangements A, B, C and D.

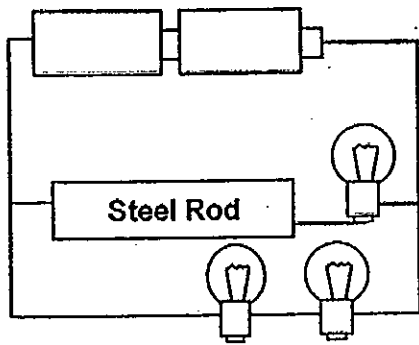

Circuit A

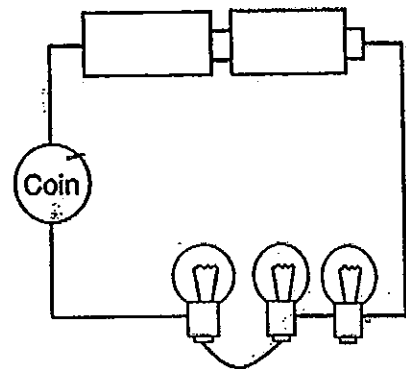

Circuit B

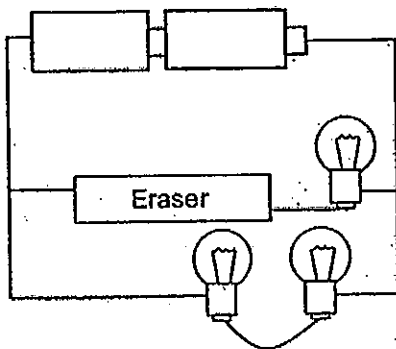

Circuit C

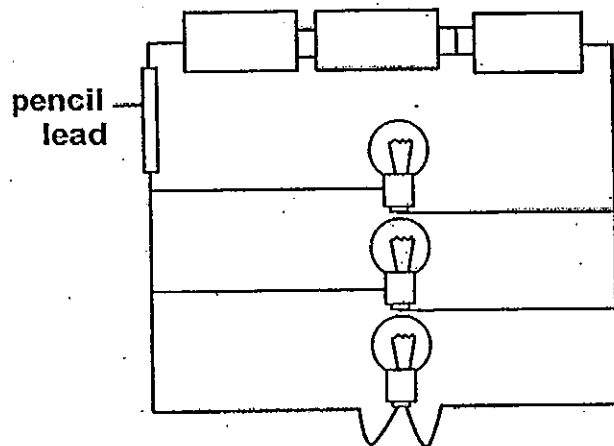

Circuit D

Which of the following circuits allow only two bulbs to light up?

- (1) A and B only
- (2) C and D only
- (3) A, B and C only
- (4) B, C and D only

23. Devi set up the circuit as shown in the diagram.

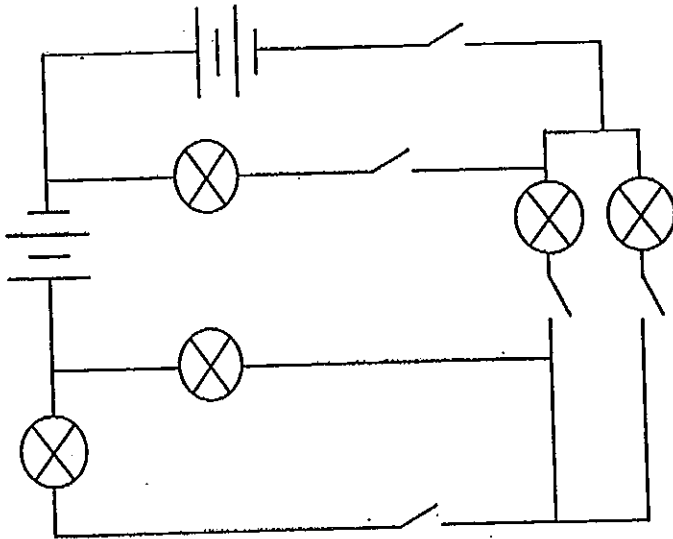

What is the least number of switch(es) that need(s) to be closed so that only two bulbs will light up?

- (1) 1
- (2) 2
- (3) 3
- (4) 4

24. The diagram below shows a circuit card and a circuit tester.

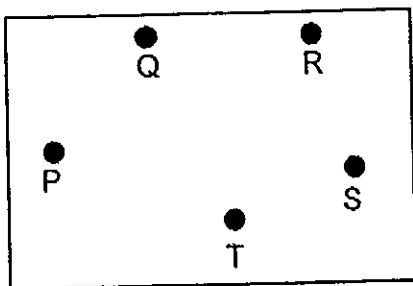

circuit card

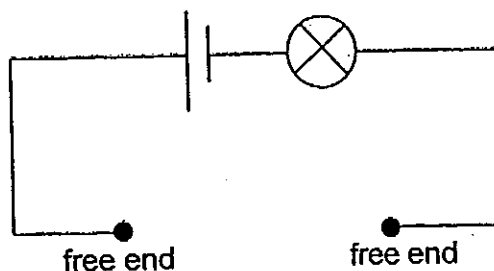

circuit tester

The table below shows what happens to the bulb when each of these points on the circuit card is connected to one free end of the circuit tester.

Points connected to the free ends of circuit tester	Does the bulb light up?
Q and S	No
P and S	Yes
Q and R	No
T and P	Yes
S and T	Yes

Based on the information given in the table above, which of the following shows the correct arrangement of the wires on the circuit card?

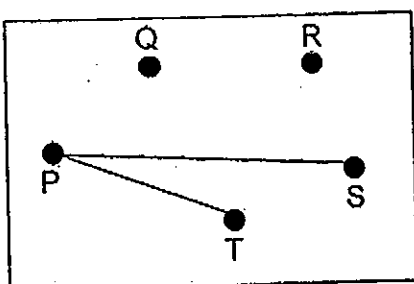

(1)

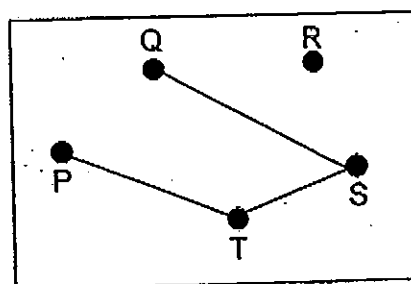

(2)

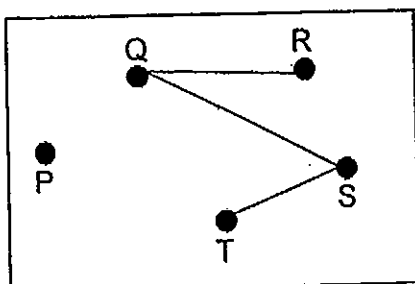

(3)

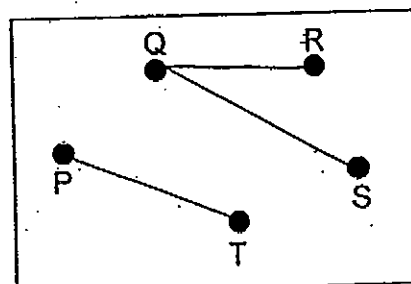

(4)

25. Five magnets with their ends marked A to J can be arranged as shown below.

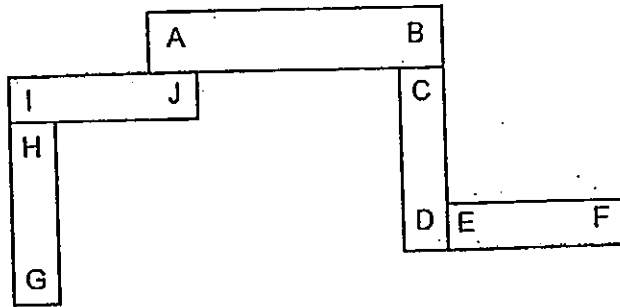

Which one of the following diagrams shows a possible arrangement of two of the magnets?

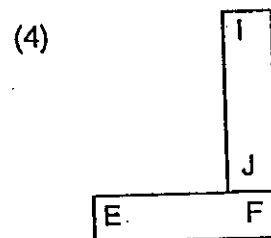
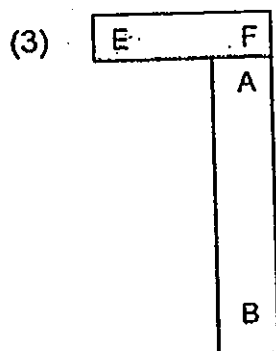
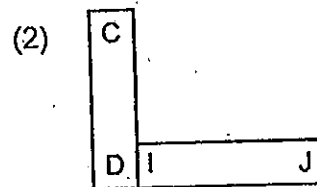
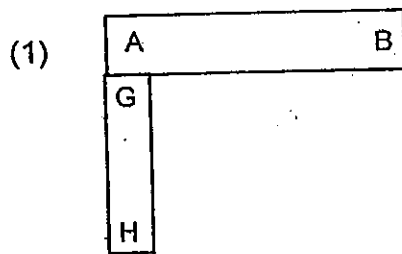

SECTION B (40 marks)

For questions 26 to 39, write your answers clearly in the spaces provided. The number of marks available is shown in the brackets [] at the end of each question or part question.

26. The diagrams below show the male sex cell joining with the female sex cell in human and plant respectively.

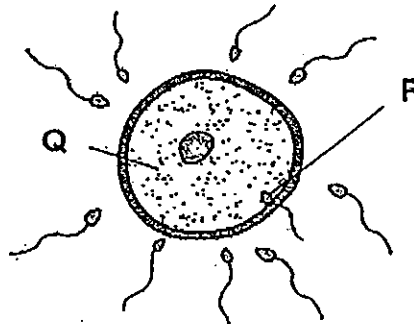

Diagram 1

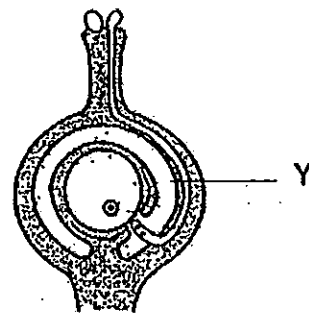

Diagram 2

- (a) State the process that is shown in diagrams 1 and 2 above. [1]

- (b) State what happens to Part Y in diagram 2 after the process stated in your answer in (a) has taken place? [1]

- (c) The journey of millions of P through the female reproductive organs to reach Q is long and difficult. Out of the millions of P released, only about 200 P will ever reach Q and only one of them will be successful in finding its way to Q.

Based on the above information, how does starting with a million of P help in the process stated in your answer in (a), when only one P is required? [1]

Score	3
-------	---

27. Sally wanted to find out if the length of the wing-like structure of a seed affects the distance it can travel. She obtained seed P from a plant which has a 3-cm wing-like structure as shown in the diagram below.

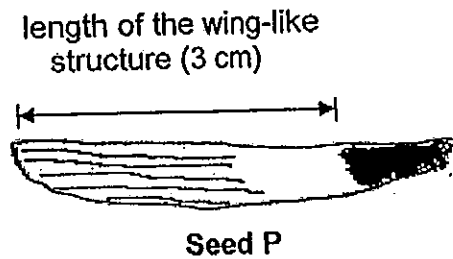

She dropped the seed from a height of 1 m and measured the horizontal distance it travelled as shown in the set-up below.

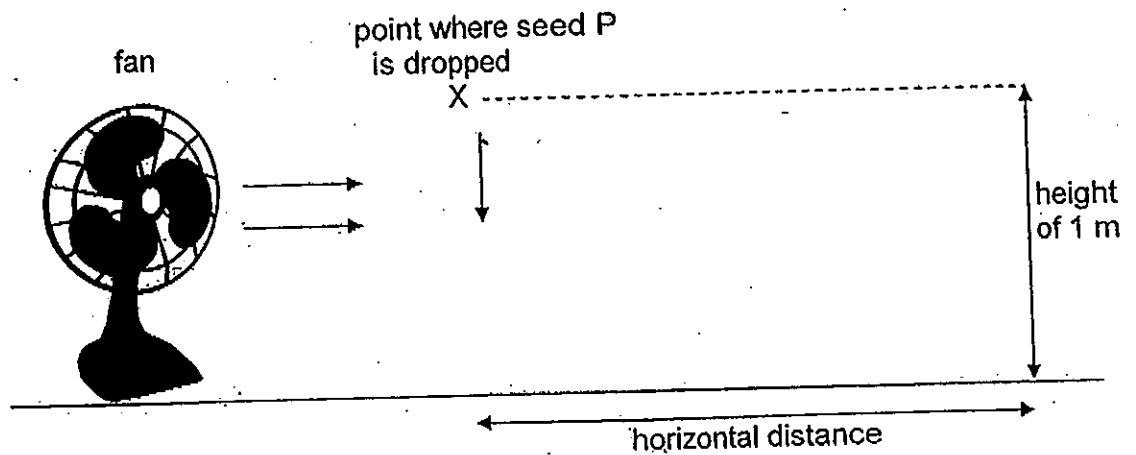

Then, she repeated the same experiment by reducing the length of the wing-like structure to 2 cm and 1 cm respectively. She then plotted her results on a graph as shown below.

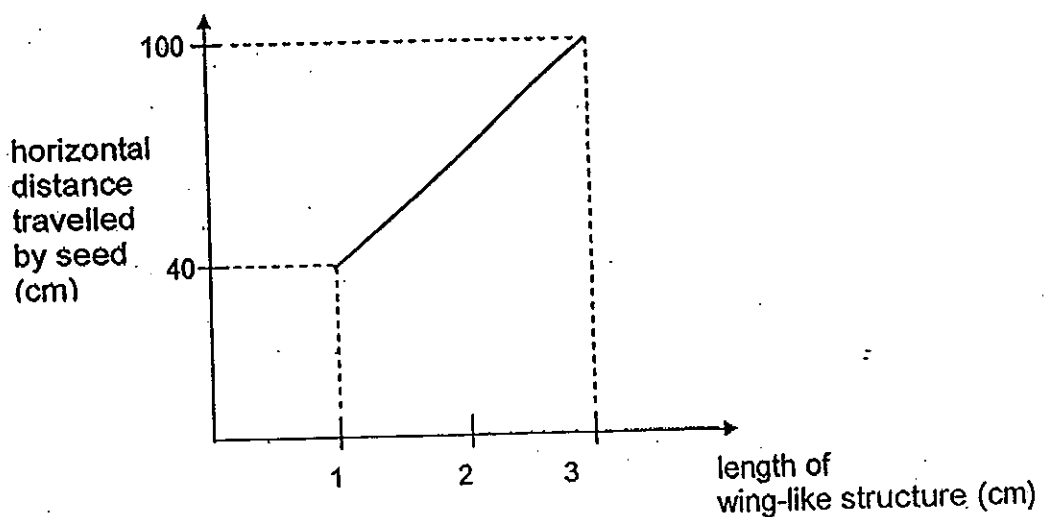

Continue from Question 27

- (a) Based on the graph, state the relationship between the length of the wing-like structure of seed P and the horizontal distance travelled by it. [1]

- (b) Based on the graph, predict the horizontal distance travelled by the seeds if its wing-like structure is totally removed.

Give a reason for your answer. [1]

- (c) Other than the wing-like structure of the seed, P, state another characteristic of the seed P that helps it to be dispersed by wind over a longer distance. [1]

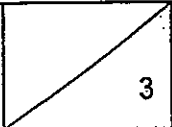
Score	
-------	---

28. Adam planted some seeds and recorded the average mass of the seed leaves and the average height of the seedlings over time.

The table below shows the mass of seed leaves of a seedling as it grew.

Day	Average mass of seed leaves (g)	Average height of seedlings (cm)
1	5.0	0.6
3	3.5	2.5
5	2.0	4.4
7	0.4	6.0

- (a) What is the relationship between the average mass of the seed leaves and the average height of the seedling? [1]

- (b) Give a reason for your answer in (a). [2]

Score	3
-------	---

29. The diagram below shows the human digestive system.

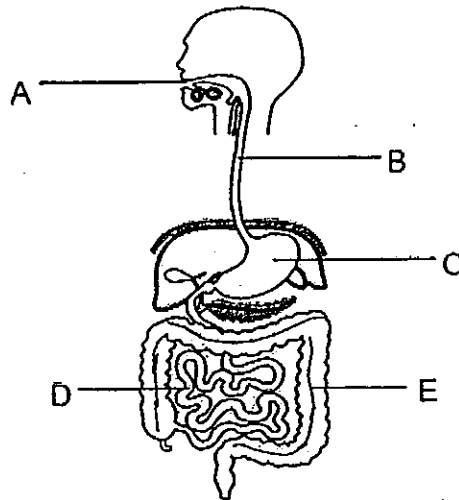

The graph below shows the percentage of undigested food in each part of the digestive system just before it travels to the next part.

(a) Draw bars to show the percentage of undigested food at B and E on the graph below. [1]

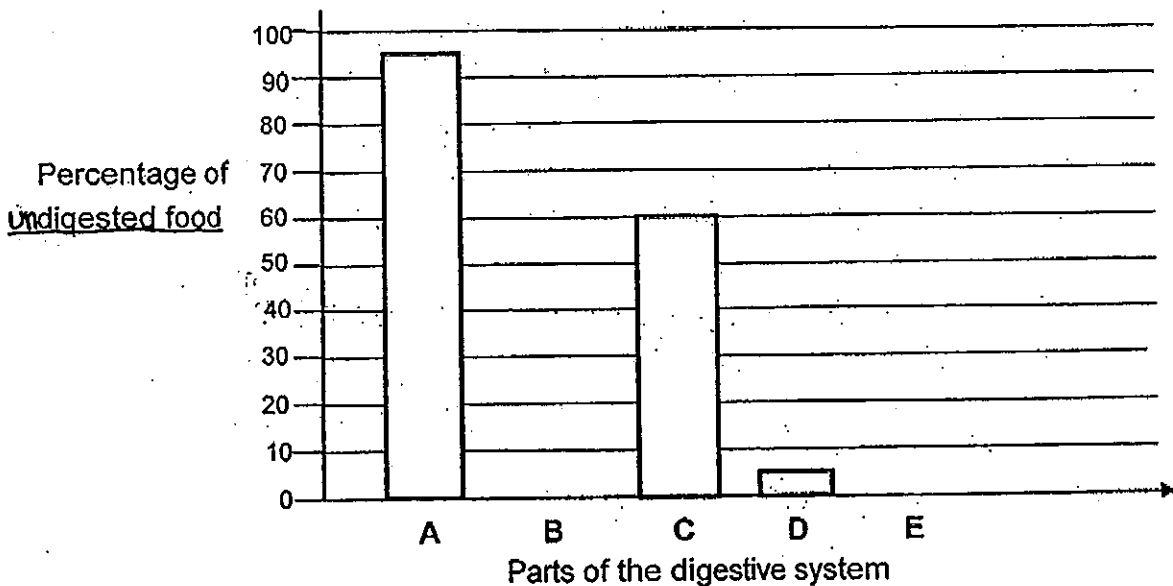

(b) Explain what happened to the digested food at D. [2]

Score	3
-------	---

30. Ming observed some cells taken from parts A and B of a plant as shown below.

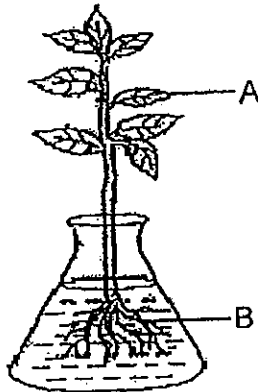

Ming found that the following cells, X and Y, taken from these parts of the plant looked different.

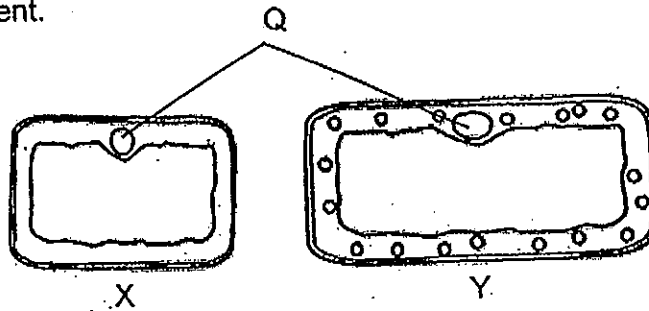

- (a) Which cell, X or Y, is taken from part B of the plant?
Give a reason for your answer.

[1]

- (b) Part Q is found in both cells X and Y.
State two functions of Part Q.

[2]

Function 1	 <hr/>
Function 2	 <hr/>

Score	3
-------	---

31. Ahmad recorded his breathing rate as he walked, ran and rested.

Ahmad's breathing rate increased as he was running.

Explain how the change in his breathing rate enabled him to complete his run. [2]

32. The diagram below shows the movement of substances in a plant.

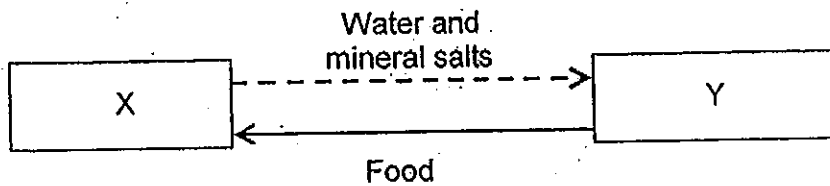

X and Y are two different parts of a plant.

(a) Identify X and Y. [1]

X: _____

Y: _____

(b) Explain what will happen to the water at Y. [1]

Score	4
-------	---

33. Kai Meng cut the outer covering of the stem of a plant as shown in the diagram below to remove a type of tubes found in the plant. He left the plant to continue to grow for two weeks. He observed that the plant did not wilt.

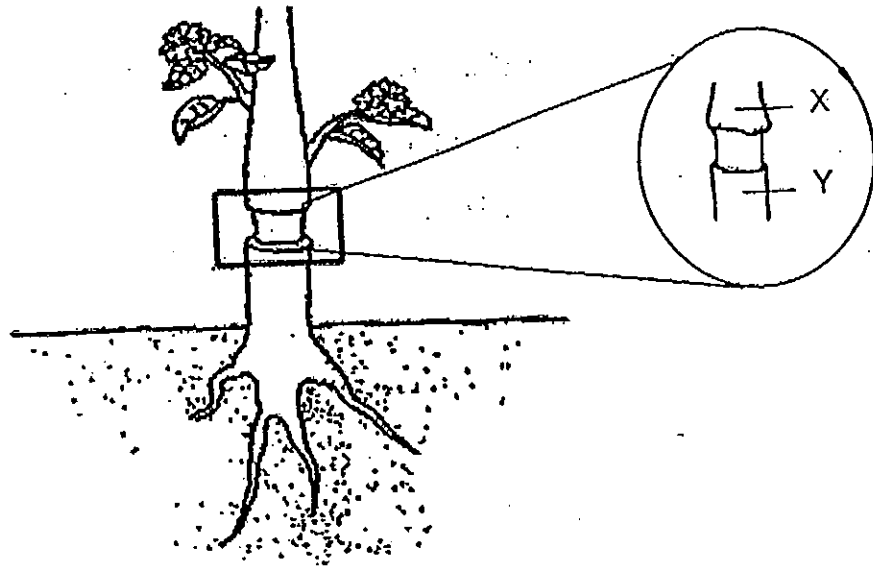

- (a) Name the tube that was removed from the stem. [1]

Kai Meng then drew his observation of the stem and labelled it as shown in the diagram below.

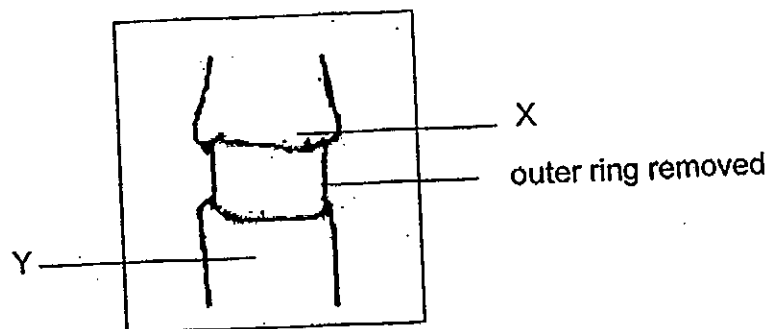

- (b) Explain clearly why part X of the stem was swollen. [1]

Score	2
-------	---

34. Anna set up an experiment using two similar plants as shown below.

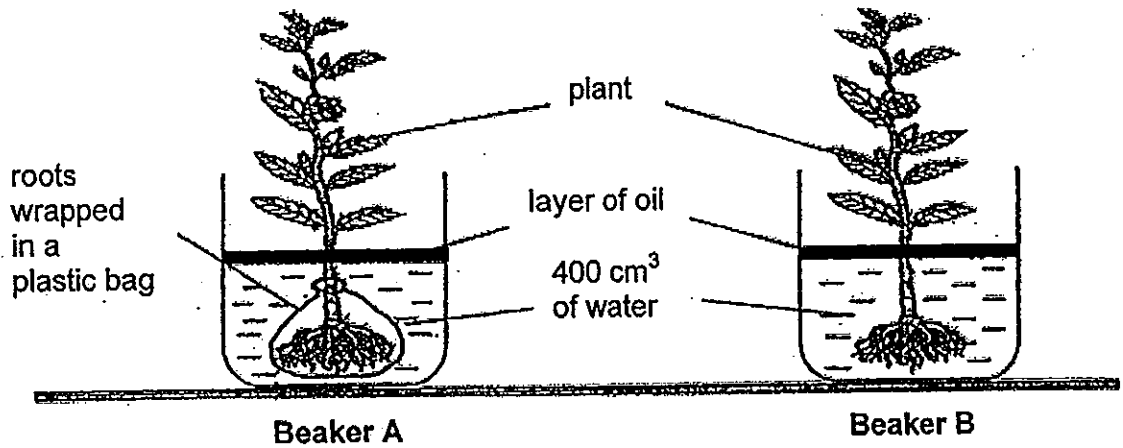

Both Beakers A and B were left at the same location and the volume of water in each beaker was measured at the end of the day. The graph below shows the changes in the volume of water in Beakers A and B over a period of 5 days.

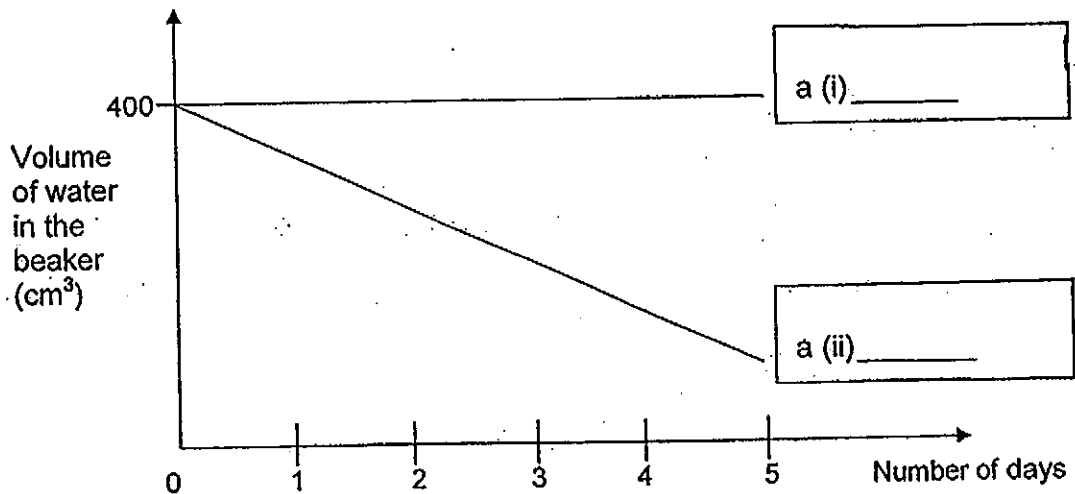

(a) In the graph above, label the lines with 'A' and 'B' in the boxes provided to show the corresponding change in the volume of water in beaker A and B. [1]

(b) Explain your answer in a (ii). [2]

Score	3
-------	---

35. John and his sister went to England during the winter season.

They saw "clouds" appearing in front of their mouths when they were talking to each other during ice skating.

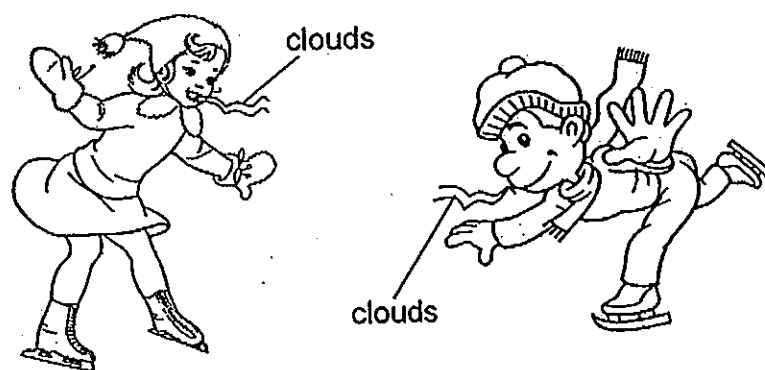

Explain clearly how the "clouds" were formed.

[2]

Score	2
-------	---

36. James wanted to design a toy that can separate metal and non-metal objects. He set up a circuit with batteries, insulated wires, a switch, iron paper clips and object X. He placed the iron paper clips at equal distance below object X as shown in the diagram below:

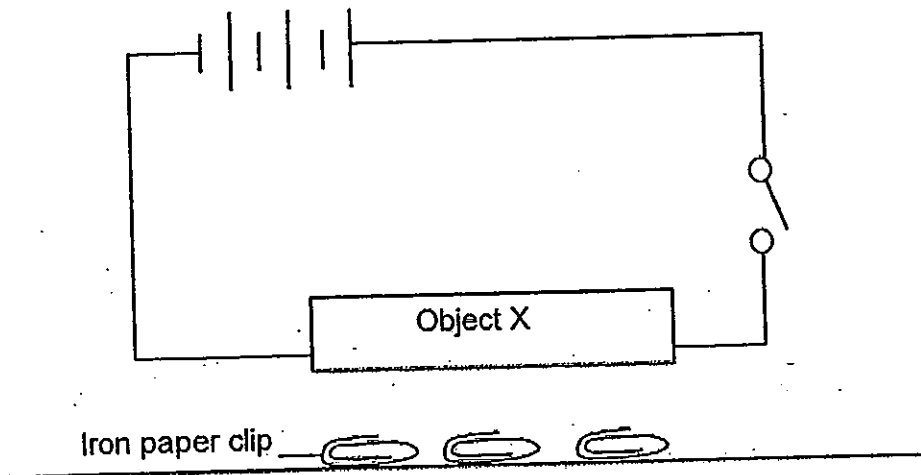

- (a) James observed that the iron paper clips were attracted to object X when the switch was closed but were not attracted to object X when the switch was opened.

Explain his observations clearly.

[2]

- (b) James replaced the iron paper clips with aluminium paper clips.

Describe what he would observe when he closed the switch. Give a reason for your answer.

[2]

Score	4
-------	---

37. Joel wanted to go night cycling with his friends. In order for his friends to spot his bicycle from afar, he has decided to add two lamps to his bicycle. He created the circuit as shown below using batteries, wires and lamps.

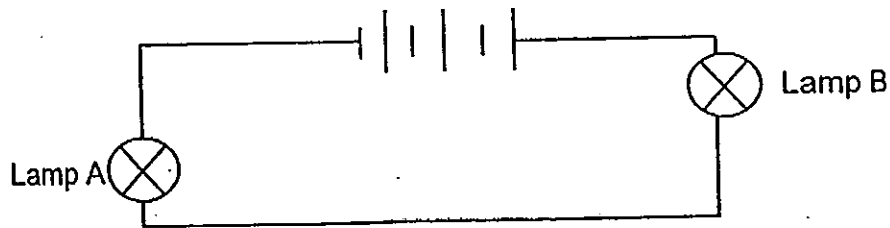

- (a) Using wires, three batteries and two lamps, **draw and label** another circuit in the box given below, such that one of the lamps will still work even if the other lamp is fused. [2]

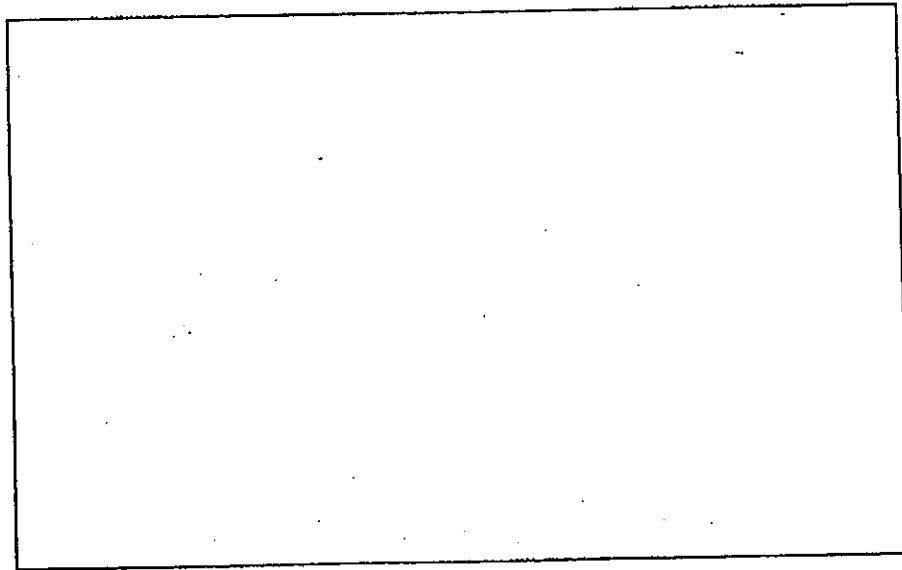

- (b) Insert a switch to the circuit drawn in (a) to control both lamps at the same time. Put an 'X' to represent where the switch should be. [1]
- (c) Besides allowing one of the lamps to work even when the other has fused, state **another** advantage of the circuit in (a) as compared to the original design that can help Joel when he cycles at night. [1]

Score	4
-------	---

38. In an experiment, Jack poured the same amount of water into two containers, A and B, made of the same materials. The two containers were placed on 2 identical hot plates respectively as shown below.

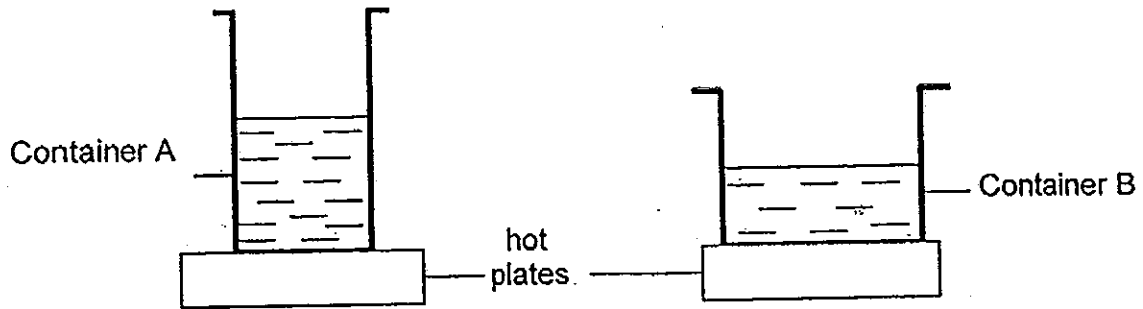

With the same amount of heat applied to both the containers, Jack measured the temperature of water in both containers at 2-minute intervals. He recorded his results as shown in the table below.

Duration (min)	Temperature of Water (°C)	
	Container A	Container B
0	26	26
2	28	30
4	40	?
6	56	70
8	76	88

- (a) Predict the possible temperature of water observed in Container B at the 4th minute. [1]
-
- (b) Explain the difference in the change in temperature of the water in the 2 containers. [2]
-
-
-

Score	3
-------	---

39. Tony wants to find out whether magnet A or magnet B has a greater magnetic strength. He made use of the items as shown in the diagram below.

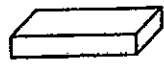

magnet A

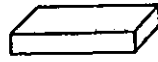

magnet B

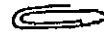

Paper clip



sticky tape

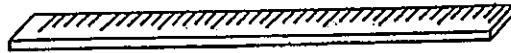

metre rule

- (a) Describe how he can carry out his experiment by adding four more steps to complete the procedure. [2]

Step	Procedures
1.	Secure magnet A at the 0-cm mark of the metre rule with sticky tape.
2.	Place paper clip at the 1-cm mark of the metre rule.
3.	
4.	
5.	
6.	

- (b) How does the recorded results help Tony to determine which magnet, A or B, has greater magnetic strength? [1]

--The End--

Score	3
-------	---

ANSWER SHEET

EXAM PAPER 2013

SCHOOL : RAFFLES GIRLS'

SUBJECT : PRIMARY 5 SCIENCE

TERM : SA2

Q1	Q2	Q3	Q4	Q5	Q6	Q7	Q8	Q9	Q10	Q11	Q12	Q13	Q14	Q15	Q16	Q17
3	3	2	1	4	2	1	3	3	1	4	4	3	4	1	1	1

Q18	Q19	Q20	Q21	Q22	Q23	Q24	Q25
1	2	3	1	4	2	1	2

26)a)Fertilisation.

b)Part Y become a fruit.

c)To ensure a sperm/P will reach Q, the egg and fuse and to be fertilised.

27)a)When the length of wing-like structure of seed P increase, the horizontal distance travelled by seed P increase.

b)0cm. Without the wing the structure, the seed cannot travel in the air.

c)It is light.

28)a)When the average mass of the seed leaves decrease, the average height of the seedling increase.

b)The food in the seed leaves had been used up by the seedling as it grew, hence, its mass decreased. When it has leaves, it can be make its own food.

29)a)

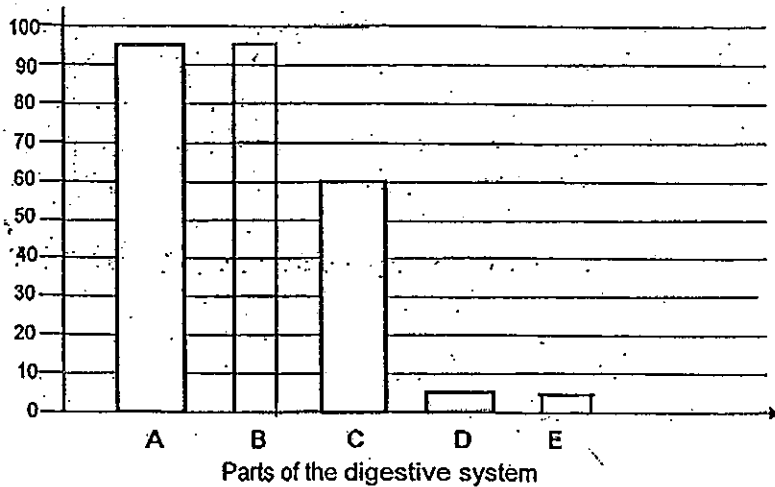

b) At D, the digested food is absorbed to the blood stream and the heart will pump it around the body.

30)a) X is taken from part B of the plant. The root cell does not make food so it has no chloroplast. Y has chloroplast but X has no chloroplast so X is taken from part B.

b)1) Contains DNA

2) Part Q control all activities occurring in the cell.

31) As Ahmad was running, his breathing rate increased so as to take in more oxygen because his heart had to beat faster too as more food and oxygen had to be carried to other parts of the body to produce more energy.

32)a) X: Roots Y: Leaves

b) Water is used up at Y to make food during photosynthesis. Some water may be lost through its stomata at Y during transpiration.

33)a) Phloem, food carrying tube.

b) As the food carrying tube is removed, the food made from the leaves is unable to transport to the lower part of the cut, so the food gather and stuck on part X and part X became swollen.

34)a) i) Beaker A ii) Beaker B

b) The roots of the plant Beaker B is not wrapped with a plastic bag so it is able to absorb the water to the rest of parts of the plant, therefore, the water level in Beaker B decrease.

35) The warm water vapour from the air mouths came into contact with the surrounding cold air and condensed to form tiny water droplets, thus the "clouds" were formed.

36)a)When the switch was closed, it formed a complete circuit so the electric current flowed through the circuit and object X became a temporary magnet so the iron paper clips were attracted to it. When the switch was opened ,it was an open circuit, electric current could not pass through the circuit so object was not magnetised and can't attract any iron paper clips.

b)The aluminium paper clips will not be attracted to the object X as aluminium is not a magnetic material.

37)a)b)

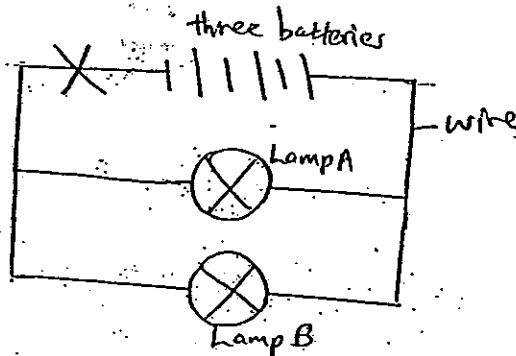

c)The bulb will light up brighter.

38)a)56°C.

b)The bigger surface area of container B is in contact with the hot plate than container A. Hence more heat was transferred to the water in B than A. So the water in B gained heat faster than A.

39)a)3)Record if the paper clip is attracted to magnet A.

4)Place the paper clip at the 2cm mark, 3cm mark, 4cm mark and so on until it cannot be attracted to magnet A.

5)Repeat the experiment for magnet B.

6)Record the longest distance each magnet can attract the paper clip and compare.

b)See which magnet can attract the paper clip at the paper clip in the further distance, has a greater magnetic strength.

