



NANYANG PRIMARY SCHOOL

PRIMARY 5 SCIENCE

**SEMESTRAL ASSESSMENT 2
2013**

BOOKLET A

Date : 28 October 2013

Duration : 1 h 45 min

Name : _____ ()

Class: Primary 5 ()

**DO NOT OPEN THIS BOOKLET UNTIL YOU ARE TOLD TO DO SO.
FOLLOW ALL INSTRUCTIONS CAREFULLY.**

Booklet A consists of 22 printed pages including this cover page.

Section A (30 x 2 marks = 60 marks)

For each question from 1 to 30, four options are given. One of them is the correct answer. Make your choice (1, 2, 3 or 4). Shade the correct oval (1, 2, 3 or 4) on the Optical Answer Sheet provided.

1. Study the diagram below.

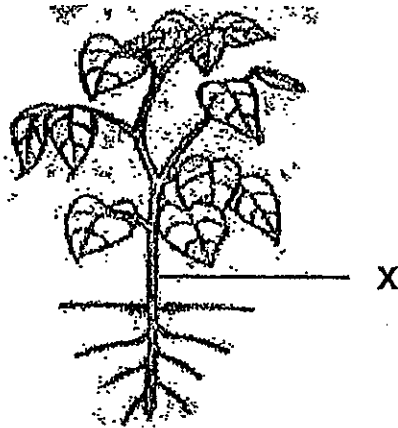

Which of the following statements explain the importance of the part labelled X?

- A It supports the branches and leaves.
- B It holds the plant firmly to the ground.
- C It transports food from the leaves to the roots.
- D It transports water and mineral salts from the roots to other parts of the plant.

- (1) A and B only
- (3) A, C and D only

- (2) B and C only
- (4) B, C and D only

2. The diagram below shows the female reproductive system.

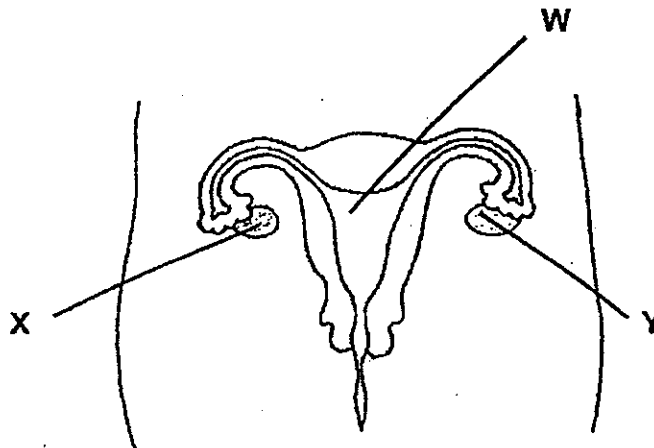

Which of the following statements are true?

- A X and Y are the ovaries.
 B W provides nutrients to the foetus.
 C X can still produce eggs if Y is missing.
 D W is the place where the fertilised egg will develop into a foetus.
- | | |
|---------------------|---------------------|
| (1) A and B only | (2) C and D only |
| (3) B, C and D only | (4) A, C and D only |

3. Mark made a model of the human respiratory system as shown.

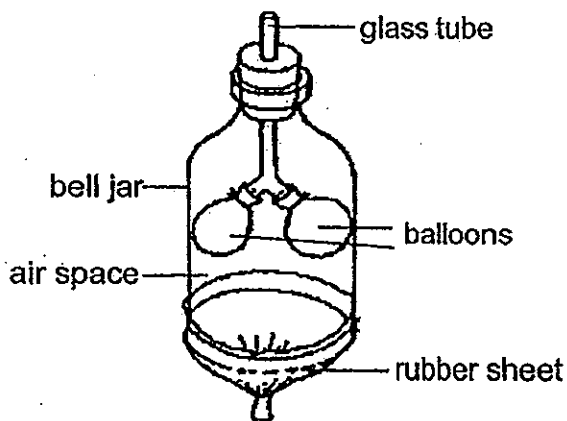

What would happen to the balloons when the rubber sheet at the end of the jar was pulled and then let go?

- (1) The balloons would inflate only.
 (2) The balloons would deflate only.
 (3) The balloons would inflate and then deflate.
 (4) The balloons would deflate and then inflate.

4. Besides the blood and the heart, which one of the following consists of parts of the circulatory system?

- (1) muscles, veins and bones
- (2) oxygen, cells and capillaries
- (3) veins, arteries and capillaries
- (4) arteries, veins and diaphragm

5. Peter received 2 slides with cells X and Y from his teacher. He observed them under a microscope and drew what he saw.

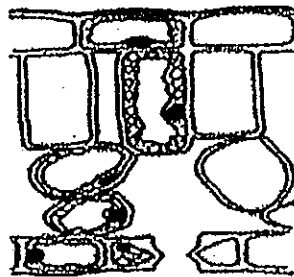

cells X



cells Y

From the diagrams above, what conclusions could he make about X and Y?

- A X are plant cells while Y are animal cells.
- B Cells Y contain chloroplasts while cells X do not.
- C The nucleus is located in the centre of the cells in X and Y
- D The cytoplasm is surrounded by the cell membrane in X and Y

- (1) A and B only
- (3) B and C only

- (2) A and D only
- (4) C and D only

6. Fifteen green bean seeds were soaked in 50ml of water at different temperatures. After soaking for one day, the beans were transferred into individual containers containing cotton wool. The number of seeds that germinated after 3 days was then counted. The results were shown in the table below.

Temperature of water during soaking	25°C	35°C	40°C	45°C
Number of seeds soaked	15	15	15	15
Number of seeds that germinated	9	12	5	0

Which of the following **cannot** be concluded from the information given in the table?

- (1) The amount of water affected the growth of the seeds.
- (2) Most number of seeds soaked in water at 35°C germinated.
- (3) More seeds germinated when soaked in water at 35°C than those soaked in water at 25°C.
- (4) The temperature of water which the seeds were soaked in affected how fast the seeds germinated.

7. Which of the following are causes of water pollution?

- A Oil spills from ships.
- B Release fertilizer into a river.
- C Throwing litter into the drain.
- D Dumping factory waste into the seas

- (1) A, B and C only
- (2) A, C and D only
- (3) B, C and D only
- (4) A, B, C and D

8. Two sealed identical glass bottles were left on the table for a few minutes. Water droplets were soon formed on the bottles as shown in the diagram below.

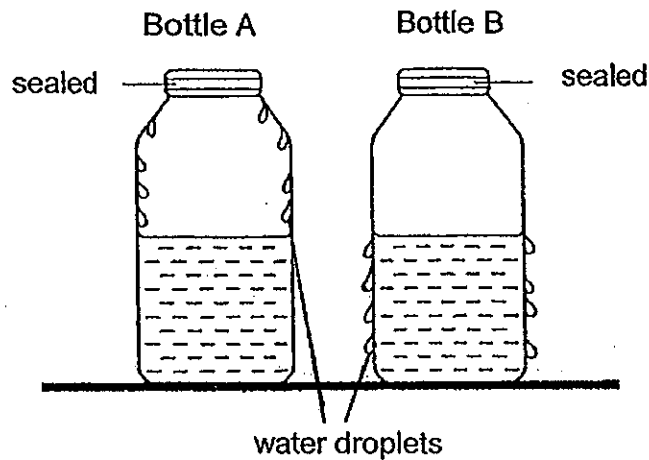

Which one of the following identifies the temperature of the water in the bottles correctly?

	Bottle A	Bottle B
(1)	Iced water	Iced water
(2)	Hot water	Iced water
(3)	Iced water	Hot water
(4)	Hot water	Hot water

9. Which of the following are possible ways in which we can conserve water?

- A Wash the dishes under running water
- B Brushing our teeth without turning off the tap.
- C Use a pail of water to wash the car instead of a water hose.
- D Reuse water that is being used from washing vegetables to water the plants

- (1) A and B only
- (2) C and D only
- (3) B, C and D only
- (4) A, C and D only

10. Study the diagram of a circuit shown below.

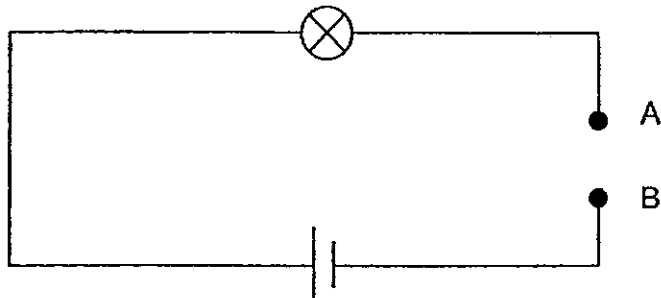

Which one of the following should be placed between A and B so that the bulb would light up?

- (1) an eraser
- (2) a glass rod
- (3) a pencil lead
- (4) a plastic spoon

11. Switches S1, S2 and S3, and bulbs L1 and L2 are connected in a circuit as shown below. All the parts of the circuit are working properly.

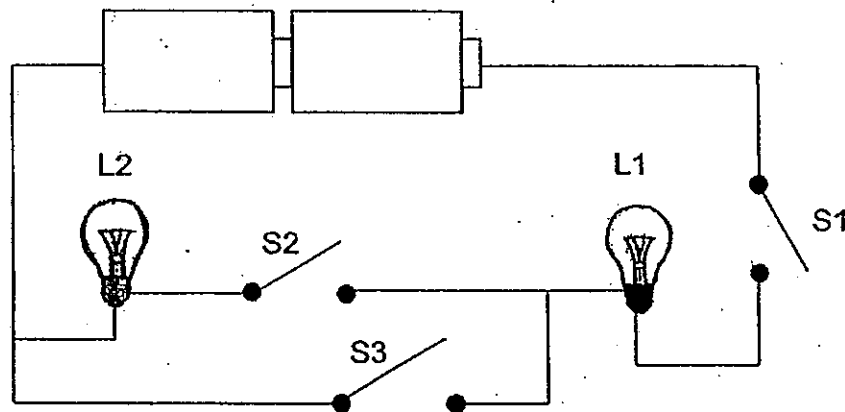

Which one of the following is correct?

	Switches			Do the bulbs light up?	
	S1	S2	S3	L1	L2
(1)	open	open	closed	no	yes
(2)	open	closed	open	yes	no
(3)	closed	closed	open	no	yes
(4)	closed	open	closed	yes	no

12. The diagram below shows four circuit diagrams with different arrangement of identical batteries and light bulbs.

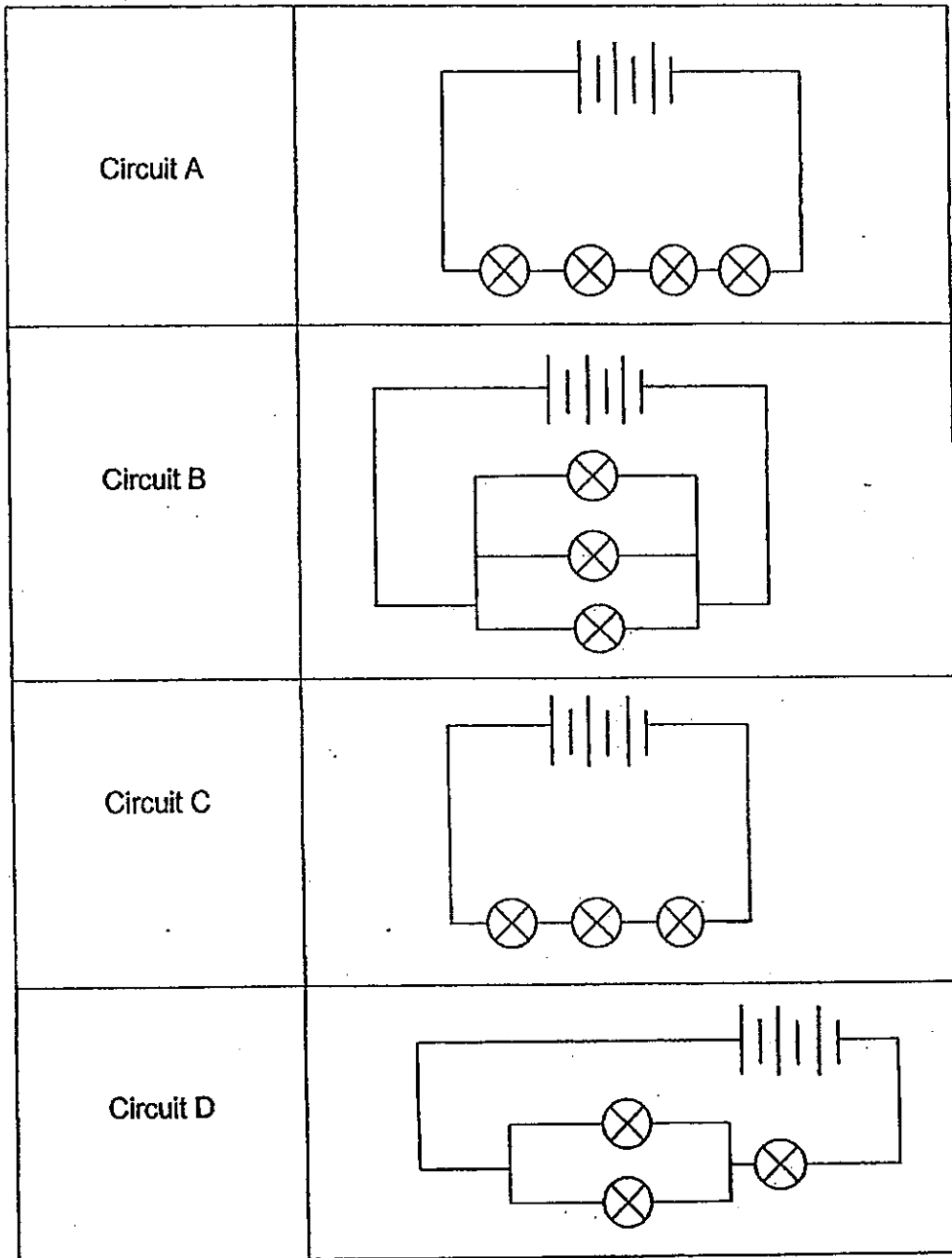

Which of the following shows the correct arrangement of the bulbs from the dimmest to the brightest?

	dimmest → brightest
(1)	A, B, C, D
(2)	A, C, B, D
(3)	A, C, D, B
(4)	B, D, C, A

13. Study the circuit below.

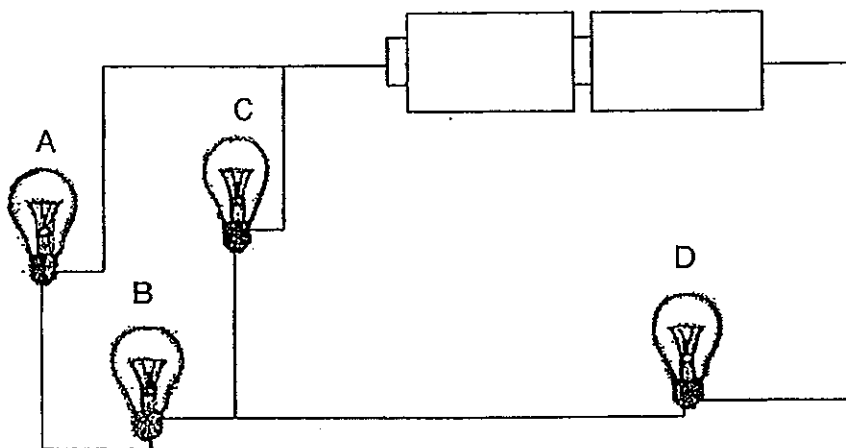

Which bulb(s), if faulty, will result in only two other bulbs lighting up in the circuit?

- (1) A only
- (3) A and B only

- (2) C only
- (4) C and D only

14. Li Ling set up a circuit as shown in the diagram below.

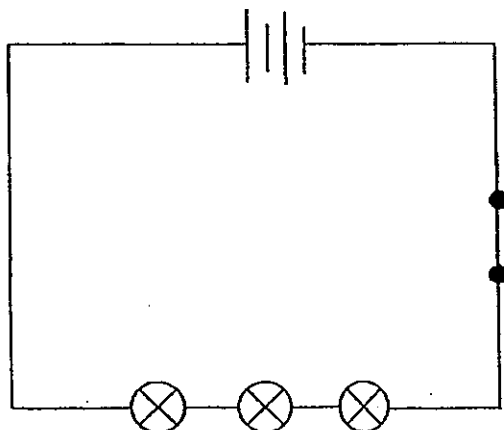

She decided to make some changes to the circuit to increase the brightness of the bulbs. Which of the following statements describe what she should do?

- A Lengthen the wire in the circuit.
- B Add more batteries to the circuit.
- C Remove some bulbs from the circuit.

- (1) A and B only
- (3) B and C only

- (2) A and C only
- (4) A, B and C

15. Study the circuit diagrams below.

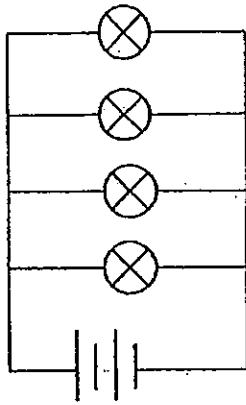

Circuit A

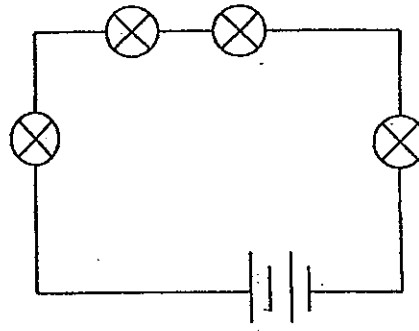

Circuit B

If one of the bulbs in each circuit fused, what is the largest number of bulbs that would remain lit?

Largest number of bulbs that would remain lit		
	Circuit A	Circuit B
(1)	0	0
(2)	0	3
(3)	3	3
(4)	3	0

16. Xin Neng set up a circuit tester and used some materials to close the circuit. He recorded his findings in the table below.

Material tested	Brightness of the bulb
silver fork	very bright
copper nail	bright
cotton cloth	not lit
salt water	very bright
tissue paper	not lit
aluminium foil	bright

Based on the table above, which of the following are correct conclusions of the experiment?

- A All metals are conductors of electricity.
- B All non-metals are non-conductors of electricity.
- C Silver and salt water are the best conductors of electricity
- D Copper is a better conductor of electricity than aluminium

- (1) A and B only
- (3) A, B and C only

- (2) A and C only
- (4) B, C and D only

17. Su Lin wants to find out how the number of batteries affects the brightness of a bulb in an electric circuit.

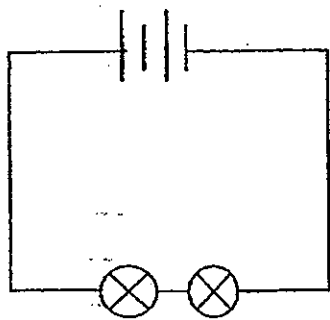

Set-up A

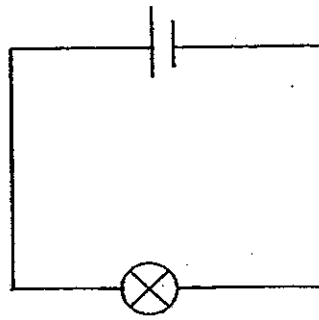

Set-up B

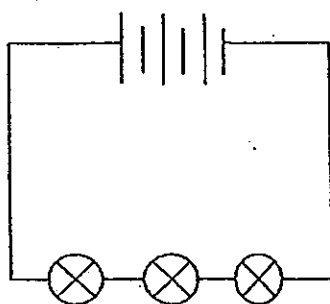

Set-up C

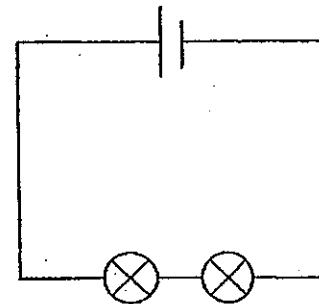

Set-up D

From the four set-ups shown above, which two set-ups should she use to ensure a fair test?

- (1) A and B
(3) B and C

- (2) A and D
(4) B and D

18. Jon set up an electric circuit using three batteries and a bulb as shown in the diagram below.

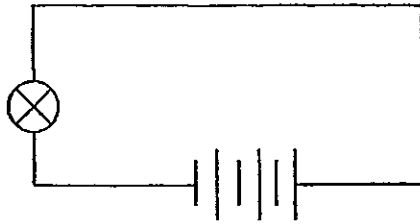

In which one of the following circuits below would each bulb have the same brightness as the bulb in the circuit above?

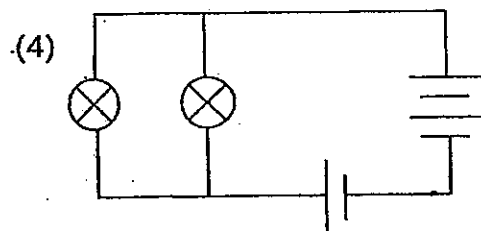
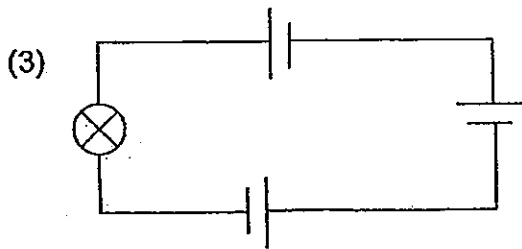
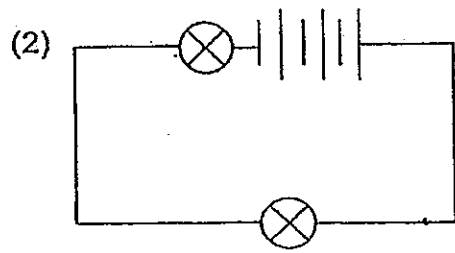
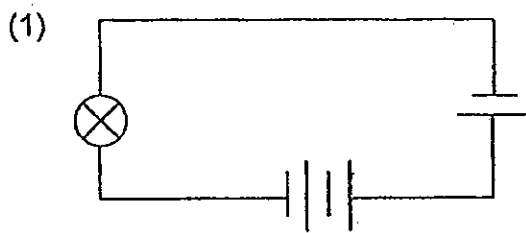

19. Bee Bee tested two switches of an electric circuit. She recorded the results in the table below.

Switch Y	Switch Z	Number of bulbs lighted
off	on	1
on	off	1
off	off	0
on	on	2

Which one of the following circuits could represent the circuit that Bee Bee had used?

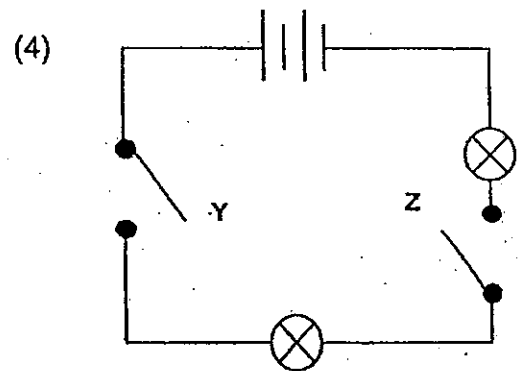
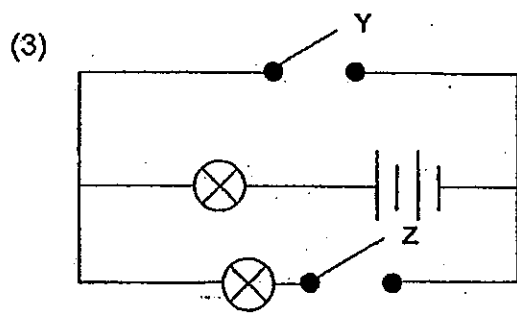
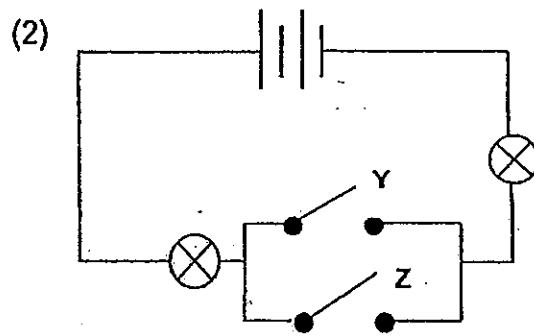
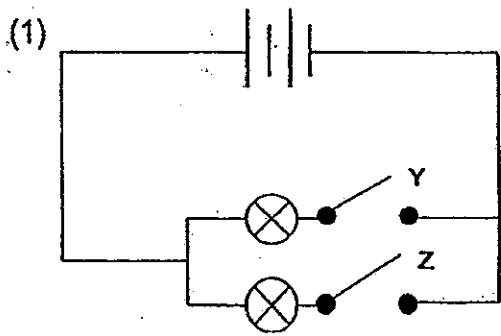

20. Adeline set up an electrical circuit as shown below.

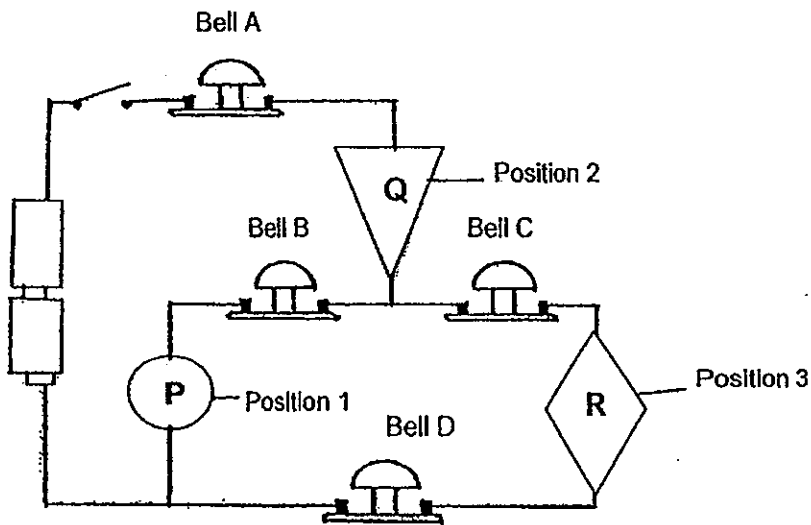

Three different objects, P, Q and R, were placed at positions 1, 2 and 3. All the bells were functioning properly throughout the experiment.

When the switch was closed, it was observed that only bells A and B rang. The positions of objects P, Q and R were then rearranged.

Which one of the following is a possible observation?

	Positions			Did the bell ring?			
	1	2	3	A	B	C	D
(1)	Q	R	P	no	no	yes	yes
(2)	R	Q	P	yes	no	yes	yes
(3)	Q	P	R	no	no	yes	yes
(4)	P	R	Q	yes	no	yes	yes

21. Which of the following statements about the effects of a force are true?

- A A force can change the shape of a moving object.
- B A force can change the speed of a moving object.
- C A force can change the direction of a moving object.

- (1) A and B only
- (2) B and C only
- (3) A and C only
- (4) A, B and C.

22. The diagram below shows a man throwing a javelin.

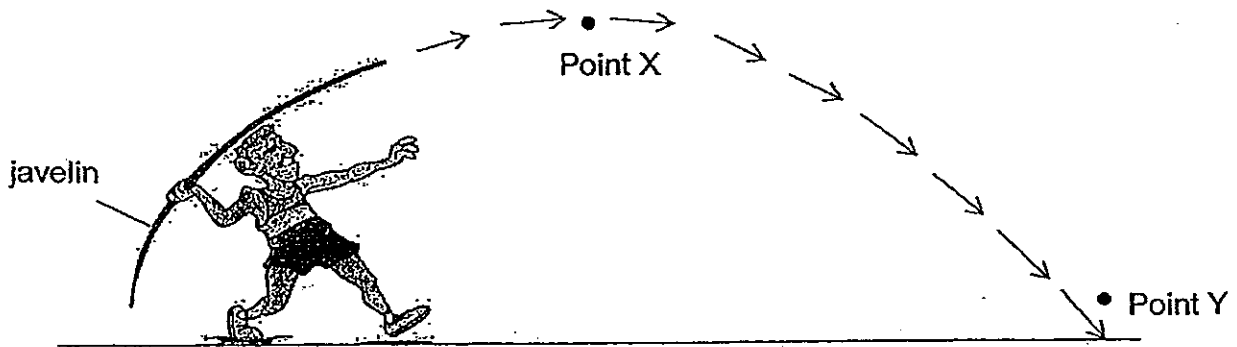

The javelin stays in the mid-air for a few seconds before landing on the ground. Which one of the following statements about the moving javelin is true?

- (1) No force is acting on the javelin when it is at point X.
- (2) The javelin travels at the same speed from point X to point Y.
- (3) Gravitational force only acts on the javelin when it is at Point X.
- (4) Gravitational force is acting on the javelin from point X to point Y.

23. Jeremy tried to pull two boxes filled with different substances as shown below.

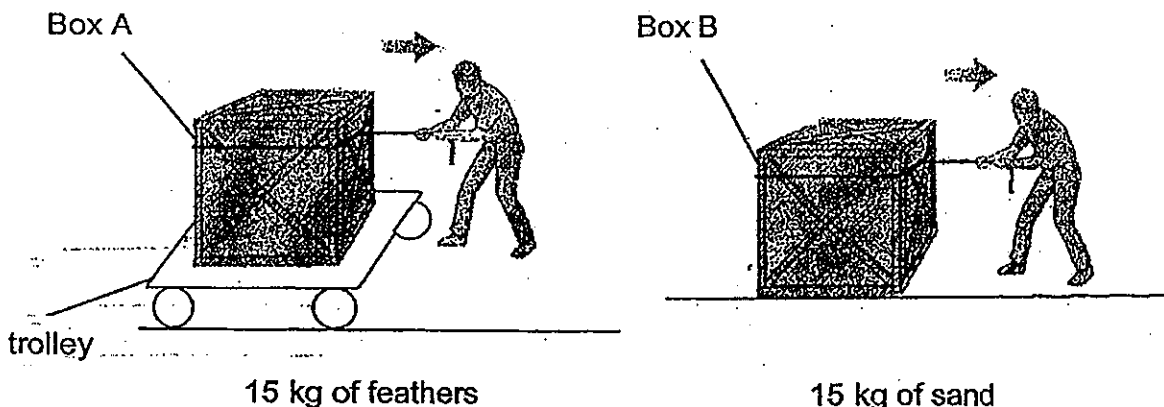

He had more difficulty pulling Box B than Box A. Which of the following could be the possible reason(s)?

- A Less force is required to pull Box A.
- B The sand is heavier than the feathers.
- C There is no friction between Box B and the floor.

- (1) A only
- (2) B and C only
- (3) A and C only
- (4) A, B and C

24. The diagrams below show the soles of 4 shoes that Zechariah owns. Which one of the following is the most suitable for walking on a rainy day to prevent slipping?

(1)

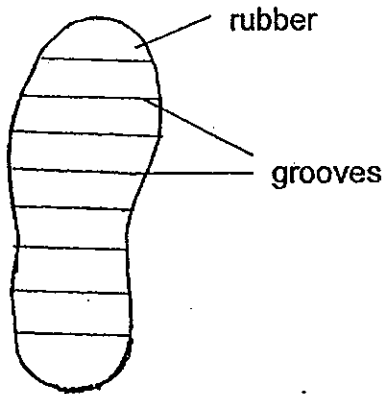

(2)

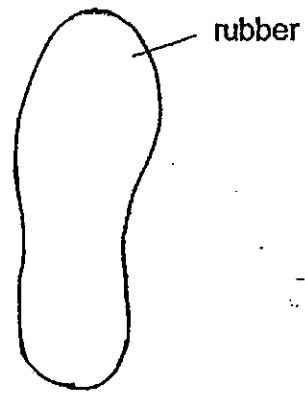

(3)

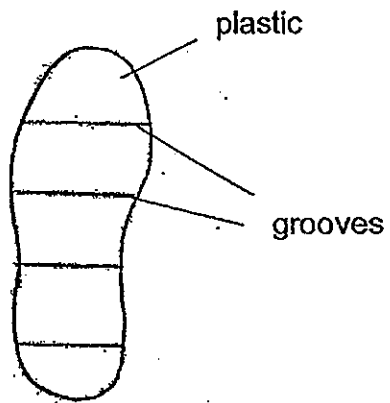

(4)

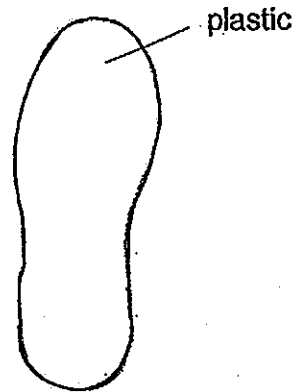

25. The experiment below shows some iron nails stuck onto the sides of a beaker. The rest of the iron nails remain at the bottom of the beaker.

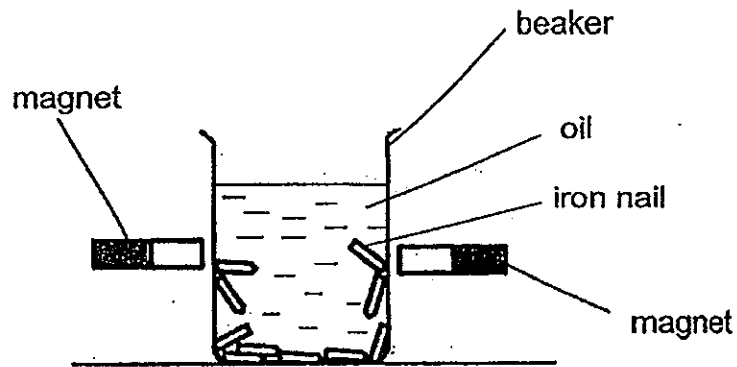

Which of the following conclusions could be made from the above experiment?

- A The magnetic force cannot pass through the oil.
- B The iron nails are attracted by the magnetic force.
- C There is magnetic force passing through the beaker.
- D The beaker attracts the iron nail with its magnetic force.

- (1) A and B only
- (3) B and C only

- (2) A and C only
- (4) C and D only

26. Sihui attached a magnet at the top of a ramp as shown in the diagram below.

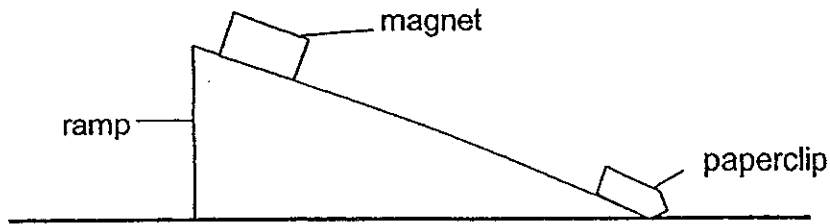

She held a paperclip at the base of the ramp. When she let it go, she observed that the paperclip moved up the ramp and eventually attached itself to the magnet.

Which of the following forces were acting on the paperclip as it moved up the ramp?

- A Frictional force
- B Magnetic force
- C Gravitational force

- (1) A and B only
- (2) A and C only
- (3) B and C only
- (4) A, B and C

27. Herman placed a football and a glass cube in front of a torch and shone light on the two objects as shown below.

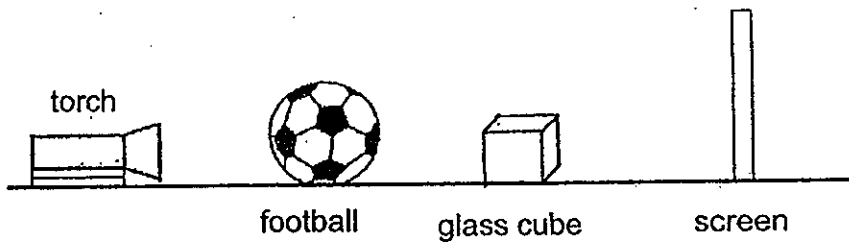

Which one of the following shadows would be formed on the screen?

- (1) 
- (2) 
- (3) 
- (4) 

30. Mr Tan carried out an experiment to compare the strength of four strings. The experimental set-up is shown below.

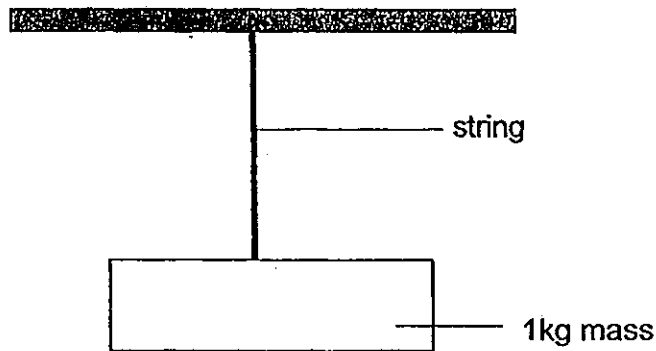

Four strings, A, B, C and D, made of different types of materials were tested. 1kg masses were added to each of the strings until the string snapped. The maximum mass that each string could carry before it snapped was recorded in the graph below.

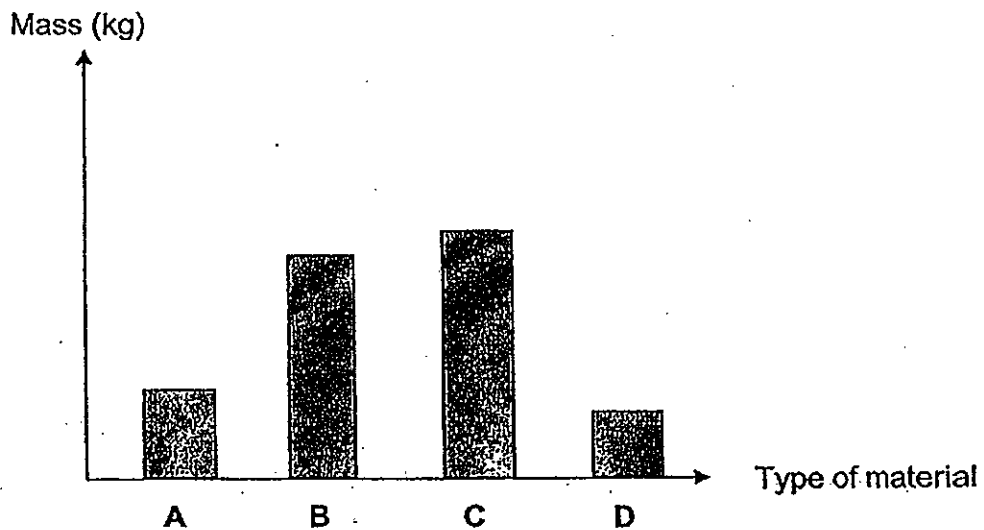

Based on the results, which one of the following statements are true?

- (1) String A is the weakest
- (2) String D is the strongest.
- (3) String A is weaker than string B but stronger than string D.
- (4) String B is stronger than string C but weaker than string A.



NANYANG PRIMARY SCHOOL

PRIMARY 5 SCIENCE

**SEMESTRAL ASSESSMENT 2
2013**

BOOKLET B

Date : 28 October 2013.

Duration : 1 h 45 min

Name : ()

Class: Primary 5 ()

Marks Scored:

Booklet A:		60
Booklet B :		40
Total :		100

**Any query on marks awarded should be raised by We
seek your understanding in this matter as any delay in the confirmation
of marks will lead to delays in the generation of results.**

Parent's signature:

**DO NOT OPEN THIS BOOKLET UNTIL YOU ARE TOLD TO DO SO.
FOLLOW ALL INSTRUCTIONS CAREFULLY.**

Booklet B consists of 15 printed pages including this cover page.

Section B (40 marks)

Write your answers to questions 31 to 44 in the spaces provided.
Marks will be deducted for misspelt key words..

31. Tom tried to pull out a plant from the ground but was unable to do so. So, he used a knife to cut the plant and pulled it out from the ground as shown in the diagram below.

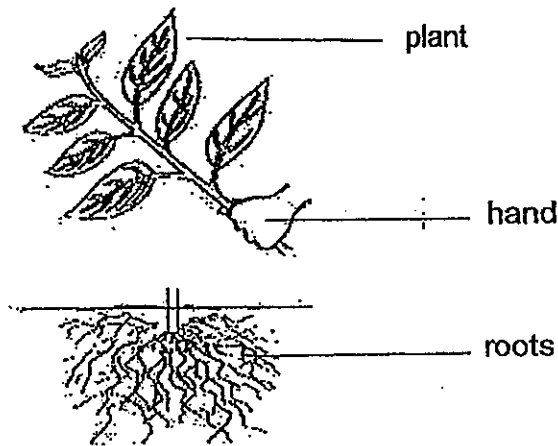

- (a) Based on the diagram, explain why Tom was not able to pull out the plant in the beginning. [1]

- (b) The part of the plant that was cut off was then planted in a garden. After a few days, the plant wilted and died even though it was given sufficient water and sunlight.

Provide a reason for the observation. [1]

32. The diagram below represents how our blood travels in the body.

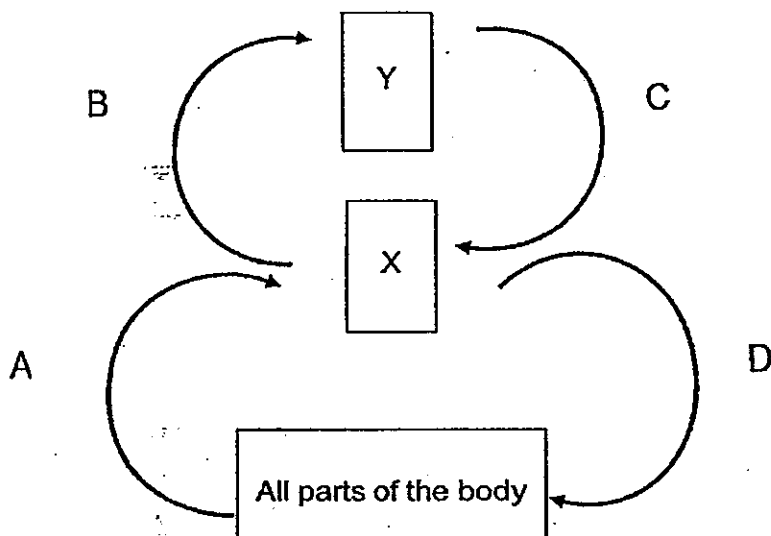

(a) The four arrows, A, B, C and D, represent the movement of blood. Boxes X and Y represent two organs in the human body.

(i) Name the two organs which X and Y represent. [1]

X: _____

Y: _____

(ii) Which arrow(s) represent(s) the movement of blood rich in carbon dioxide? [1]

(b) Which part of the blood carries oxygen around the body? [1]

33. Liming placed some white flour in a filter paper bag. She then sealed the filter paper bag and immersed it into a glass container containing blue-coloured solution and fine sand particles for three days.

After three days, she examined the filter paper bag and observed that there were traces of white flour which had turned blue but no sand particles were found in it. She obtained the same results when she repeated the experiment again.

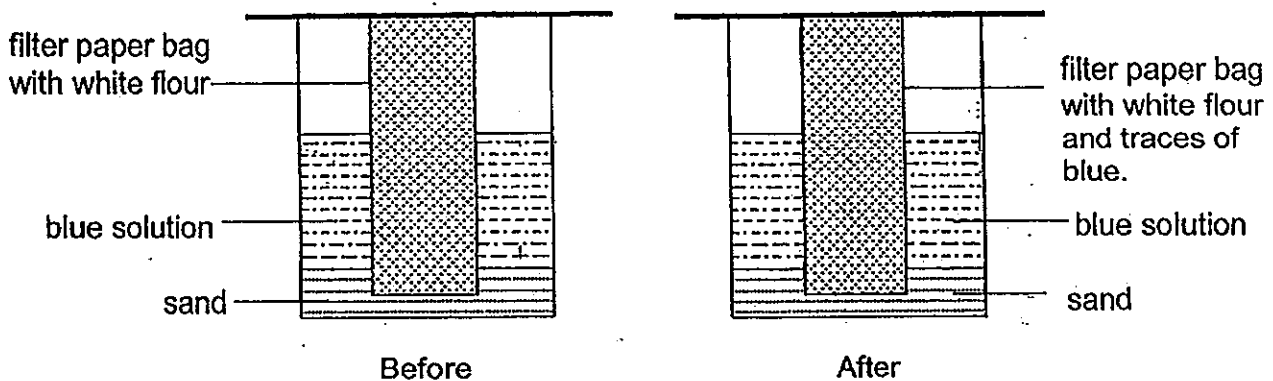

- (a) What conclusion could Liming draw about the property of the filter paper bag based on her observation after three days? [1]

- (b)(i) Name the part of a plant cell which has the same function as the filter paper bag used in the set-up above. [1]

- (ii) Explain the function of the cell part mentioned in (i). [1]

34. Devi made a paper spinner during her Science lesson as shown in the diagram below.

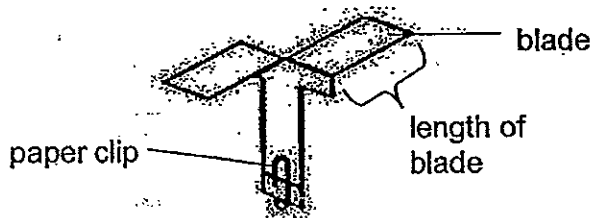

She wanted to investigate how the length of the blade affects the time taken for the paper spinner to fall to the ground. She conducted the experiment and recorded the results in the table below.

Length of blade (cm)	Time taken to fall to the ground (s)
12	10
10	8
8	6
6	3

Devi's classmates commented that the results she obtained were not reliable.

- (a) Suggest what Devi could do to ensure that her results are reliable. [1]

- (b) What conclusion could Devi draw based on the results of the experiment conducted? [1]

- (c) Devi wanted to reduce the time taken for the paper spinner to fall to the ground. Using the original paper spinner, suggest what Devi could do to the paper spinner. [1]

35. The following diagram shows a bulb and three batteries.

- (a) Draw 4 wires to show how the circuit below can be connected to make the bulb light up as brightly as possible [1]

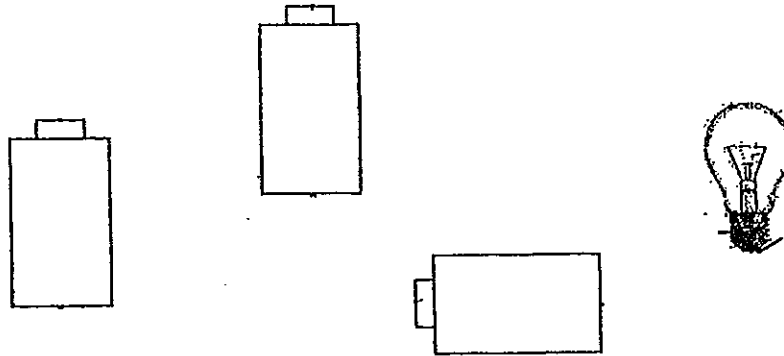

- (b) What is the function of wire in the above circuit? [1]

Ann constructed a game for her school fun fair as shown below. Wire X was connected to the curved wire at the bottom of the board.

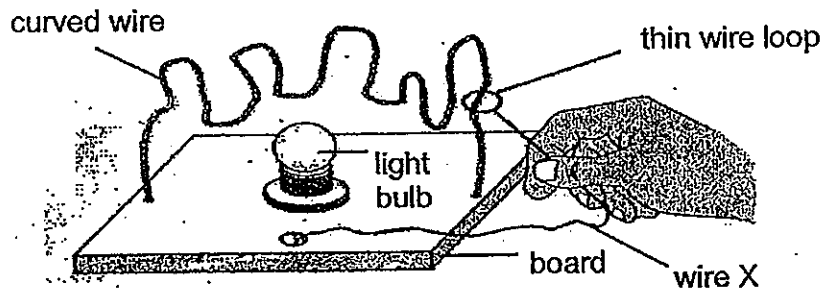

Ann tried to move the thin wire loop through the length of curved wire. When the wire loop touched the curved wire, the light bulb lit up.

- (c) Explain why the bulb lit up when the wire loop touched the curved wire. [1]

- (d) State one change Ann can make to her set-up to make it more difficult to move the wire loop through the curved wire. [1]

36. Mindy set up an electrical circuit as shown below.

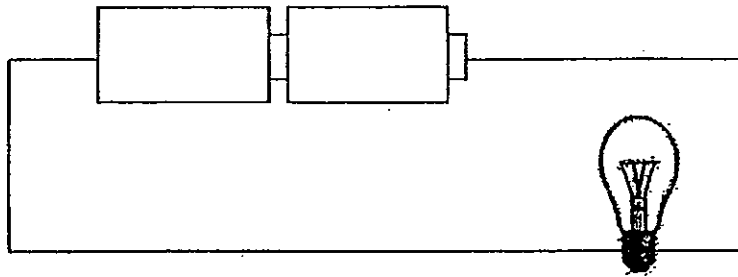

She observed that the bulb did not light up. Her friend told her that she had made a mistake in her set-up.

(a) What was the mistake that Mindy had made in her set-up? [1]

(b) After Mindy corrected her mistake, the bulb still did not light up. State a possible reason for this observation. [1]

(c) Using electrical symbols, draw the circuit diagram that correctly represents the circuit above. [2]

37. The diagram below shows a circuit tester and a circuit card consisting of five metal paper clips, A, B, C, D and E. The wires underneath the circuit card are not shown.

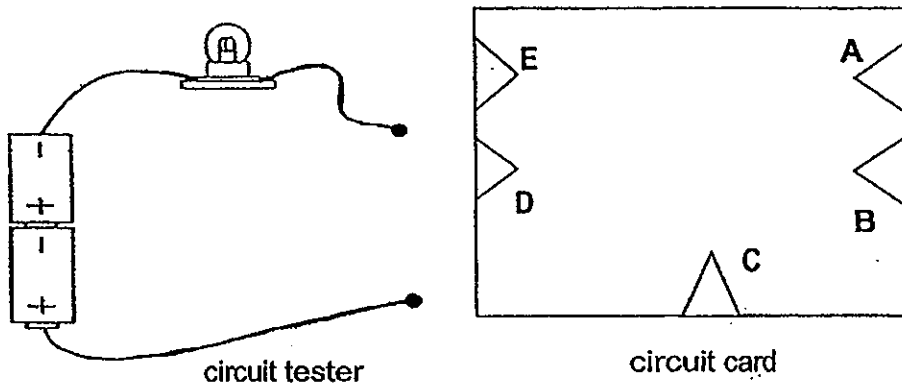

When the ends of the 2 wires of the circuit tester are connected to the paper clips on the circuit card, the bulb is either lit or unlit. The table below shows what happens to the bulb when each pair of paper clips was tested.

Paper clips connected	Bulb
A and C	Does not light up
A and B	Lights up
A and E	Lights up
B and C	Does not light up
C and D	Does not light up
B and E	Lights up

- (a) In the circuit card below, draw 2 lines only to show how the wires of the circuit card could have been connected. [1]

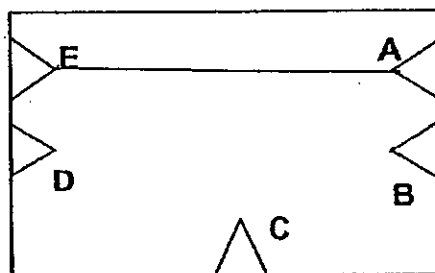

- (b) Explain why the circuit card should not be made of metal. [1]

38. Muthu threw a ball against the wall. It hit the wall, bounced off and landed on the floor. It then rolled along the floor and eventually stopped at Y. The diagram below shows the direction of the movement of the ball.

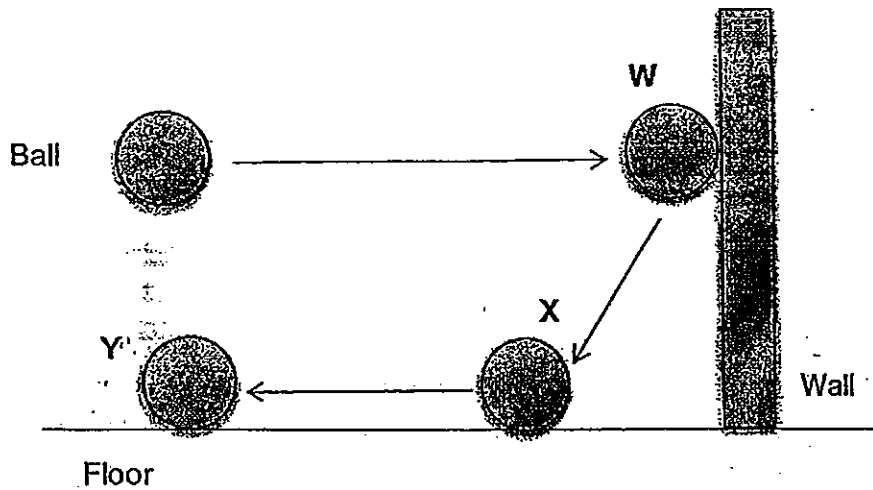

- (a) State the forces acting on the ball when it moved from W to X. [1]

- (b) Explain why the ball eventually stopped at Y. [1]

39. In the experiment shown below, a metal ball was attached to a wooden cart by a nylon string as shown in the diagram below.

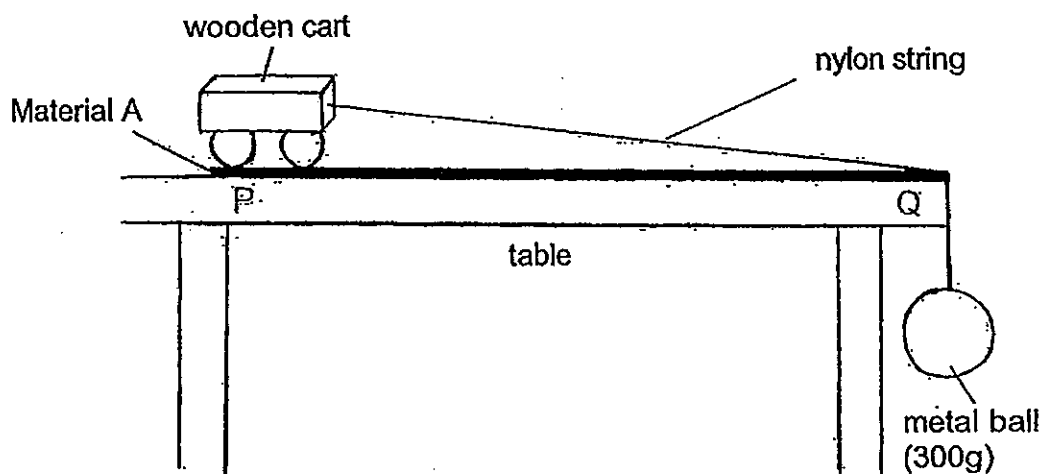

The time taken by the wooden cart to reach position Q from position P was recorded. The whole experiment was repeated using different materials on which the wooden cart moved across. The results were recorded as shown below.

Material	Time taken to reach point Q (s)
A	25
B	18
C	36
D	14

- (a)(i) Using the information in the table, which material would be the most suitable to make a ramp for pushing heavy boxes up onto a lorry? [1]

- (a)(ii) Explain your answer in (a)(i) [1]

- (b)(i) Without changing the wooden cart, what could be done to the set-up in order to make the cart move faster across the table? [1]

- (b)(ii) Explain your answer in (b)(i) [1]

40. Yong Jie was given three objects, X, Y and Z, wrapped in paper. The objects were of similar sizes. He held a magnet about 2cm away from each one of them as shown in the diagram below. Each object has parts A and B at their ends.

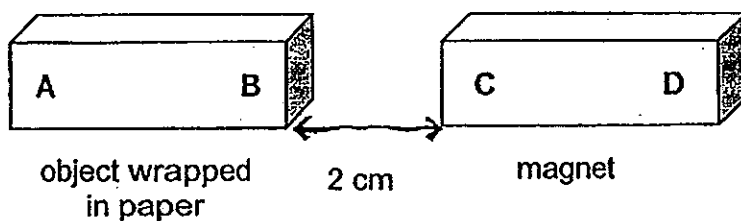

He then recorded his observations in the table below.

Object	Observations
X	It moved away from the magnet.
Y	It moved towards the magnet.
Z	It did not move.

- (a) Which one of the objects (X, Y or Z) could be made of aluminium? [1]

- (b) Using the letters (A, B, C or D) shown in the diagram above, describe what he could do to make object X move towards the magnet. [1]

41. Four towels, D, E, F and G, of the same material, thickness and size were completely soaked in water. They were then folded in the same way and placed on the table to dry, as shown in the diagram below.

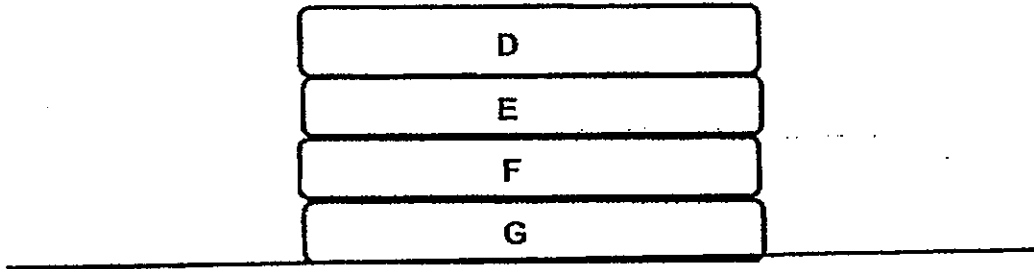

(a)(i) Which one of the towels would dry first? [1]

(a)(ii) Explain your answer in (i) [1]

(b) State two other factors that would help the towels to dry at a faster rate. [1]

(i) _____

(ii) _____

42. The table below shows the length of Ken's shadow as he walked under a lighted street lamp at night. He was not directly under the street lamp at the start of his walk.

Length of shadow (m)

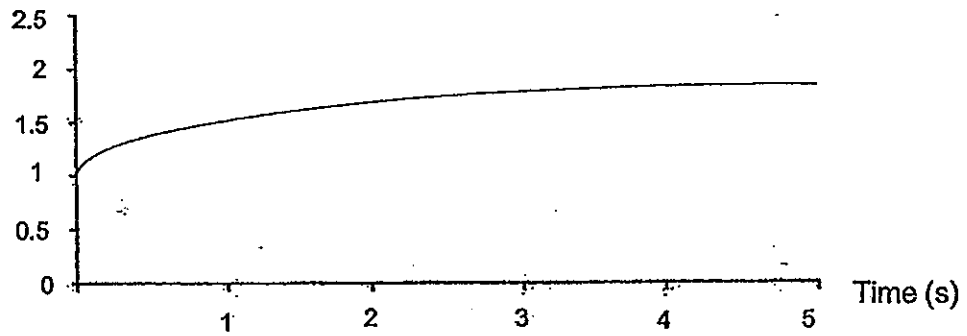

- (a) Based on the graph above, was Ken walking away from the street lamp or towards it? Explain your answer [1]

- (b) Based on the graph provided, what was the length of Ken's shadow at the start of the walk? [1]

43. Lyn carried out an experiment as shown in the diagram below. She attached two stoppers to two identical metal plates with wax. One metal plate was black and the other was white. An electric heater was placed an equal distance away from the two metal plates. Lyn then switched on the heater. After some time, she observed that one of the stoppers dropped off.

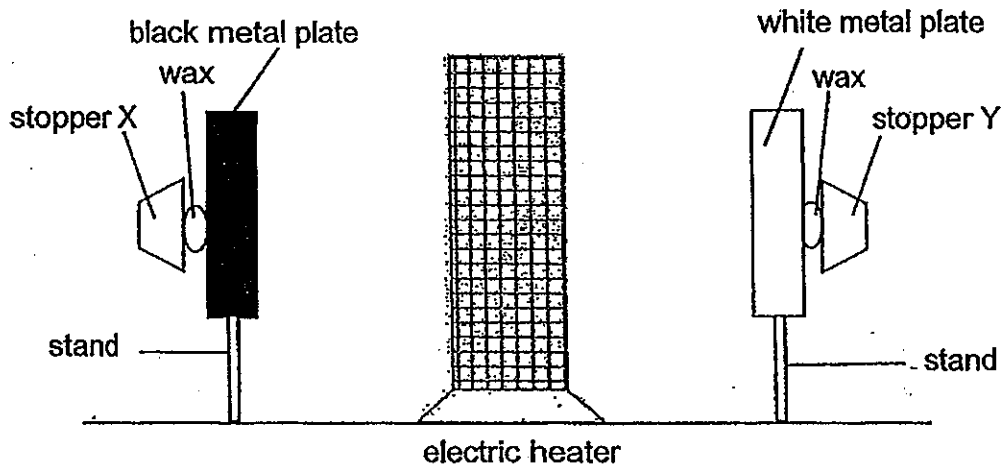

- (a) What was the aim of the experiment? [1]

- (b) Predict which stopper will drop off first and state a reason for your prediction. [1]

- (c) Lyn replaced the white metal plate with a black rubber sheet of the same size and thickness as the black metal plate and repeated the experiment. Explain which stopper would drop off first. [1]

44. Elma wanted to choose a material to make an absorbent hand towel. Four different materials, E, F, G and H, of the same size, thickness and shape were used and the experiment was set up as shown below.

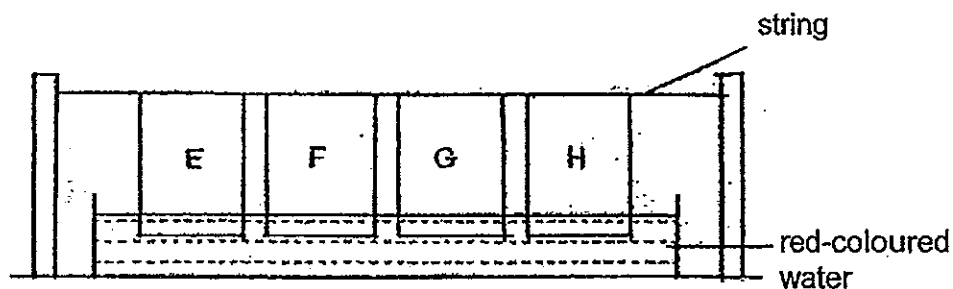

The height of the red-coloured water on the four materials were measured after three minutes. The results were recorded in the table below.

Material	E	F	G	H
Height of the red-coloured water on the material (cm)	14	5	7	3

- (a)(i) Which material should Elma choose to make a hand towel? [1]

- (a)(ii) Give a reason for your answer in (i). [1]

- (b) Why is it important to use red-coloured water to measure the height in this experiment? [1]

End of paper



ANSWER SHEET

EXAM PAPER 2013

SCHOOL : NANYANG

SUBJECT : PRIMARY 5 SCIENCE

TERM : SA2

Q1	Q2	Q3	Q4	Q5	Q6	Q7	Q8	Q9	Q10	Q11	Q12	Q13	Q14	Q15	Q16	Q17
3	4	3	3	2	1	4	2	2	3	4	3	3	3	4	2	2

Q18	Q19	Q20	Q21	Q22	Q23	Q24	Q25	Q26	Q27	Q28	Q29	Q30
1	1	2	4	4	1	1	3	4	1	2	4	3

- 31)a)As the roots is supposed to help the plant to hold firmly to the ground.
b)The plant had no roots to absorb water.

- 32)a)i)X: heart Y: lungs
ii)A and B
b)Red blood cell.

- 33)a)The filter bag allow the blue solution to go in but not the sand.
b)Cell membrane.
c)It controls the substances going in and out of the cell.

- 34)a)Devi could repeat the experiment a few more time.
b)The longer the length of blue, the longer it takes to fall to the ground.
c)She could fold the wings into half.

35)a)

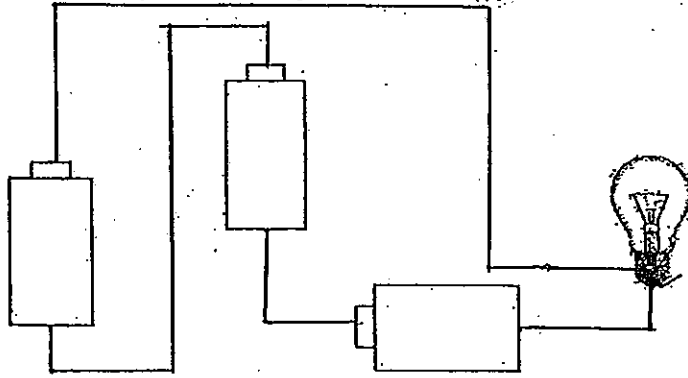

b) To allow electricity to flow through the circuit.

c) When the wire loop touches the curve wire, it forms a closed circuit.

d) Bend the wire to make a lot more loop.

36)a) She had connected both wires to metal causing.

b) The bulb might have fused.

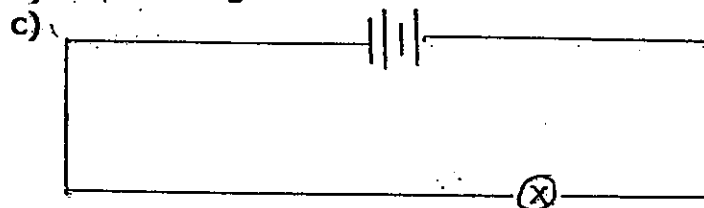

37)a)

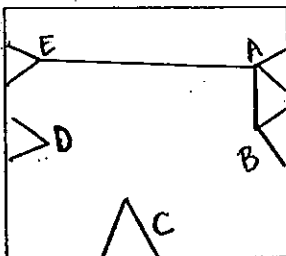

b) Metal is a conductor of electricity and thus current can flow through the card when the wire touches the card.

38)a) The force is a push and gravitational force.

b) As friction caused the ball to stop.

39)a)i)Material D.

ii)It took the least amount of time for the cart to reach Q. Thus less friction between the cart and the surface.

b)i)Make the metal ball heavier.

ii)More pulling force is exerted on the cart by the heavier ball.

40)a)Z.

b)He could turn X over, so that A is facing C.

41)a)i)D.

ii)It has the greatest exposed surface area.

b)i)Presence of wind.

ii)higher temperature.

42)a)Away from the street lamp. The shadow increases when he walks further from the lamp.

b)1m.

43)a)To find out which colour metal plate would absorb more heat.

b)Stopper X. As black absorbs heat faster than the white metal plate, so stopper X would drop first.

c)Stopper X. As metal is a better conductor of heat.

44)a)i)E.

ii)The height of the water on the material is the highest thus it is the most absorbent material.

b)As red allowed people to see but not water.

