



Rosyth School
Second Semestral Examination for 2012
STANDARD SCIENCE
Primary 5

Name: _____

Class: Pr 5 - _____ Register No. _____ Duration: 1 h 45 min

Date: 30 October 2012 Parent's Signature: _____

Booklet A

Instructions to Pupils:

1. Do not open the booklets until you are told to do so.
2. Follow all instructions carefully.
3. This paper consists of 2 booklets, Booklet A and Booklet B.
4. For questions 1 to 30 in Booklet A, shade the correct ovals on the Optical Answer Sheet (OAS) provided using a 2B pencil.
5. For questions 31 to 44, write your answers in the spaces given in Booklet B.

* This booklet consists of 18 pages.

Part I (60 marks)

For each question from 1 to 30, four options are given. One of them is the correct answer. Make your choice (1, 2, 3 or 4). Shade the correct oval (1, 2, 3 and 4) on the Optical Answer Sheet.

1 The picture below shows a plant cell.

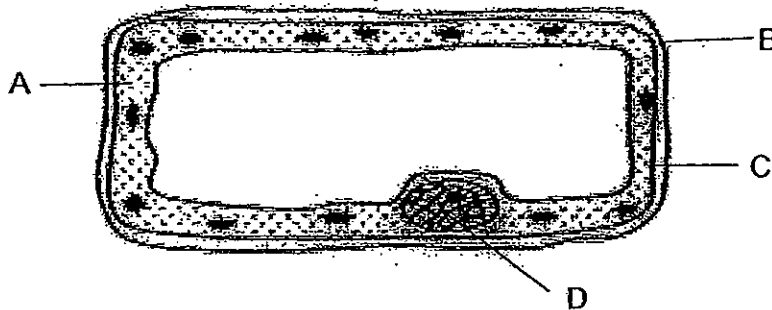

Which one of the following part of the plant cell cannot be found in an animal cell?

- (1) A
- (2) B
- (3) C
- (4) D

2 Alex wanted to see his cheek cells under a microscope.

- A: Stain the cheek cells with iodine.
- B: Observe the cheek cells under the microscope.
- C: Use a toothpick to scrape the sides of his cheek.
- D: Place the cover slip over the cells on the glass slide.
- E: Put the scraped cells on the glass slide.

Which of the following instructions are listed in the correct order for Alex to use a microscope to see his cheek cells?

- (1) C, B, A, D, E
- (2) C, E, A, D, B
- (3) D, A, E, C, B
- (4) E, D, A, C, B

- 3 Mei Ling had two identical set-ups, A and B, as shown below. The roots of the plant in set-up B is wrapped in a plastic bag. Both set-ups are placed under strong sunlight during the experiment.

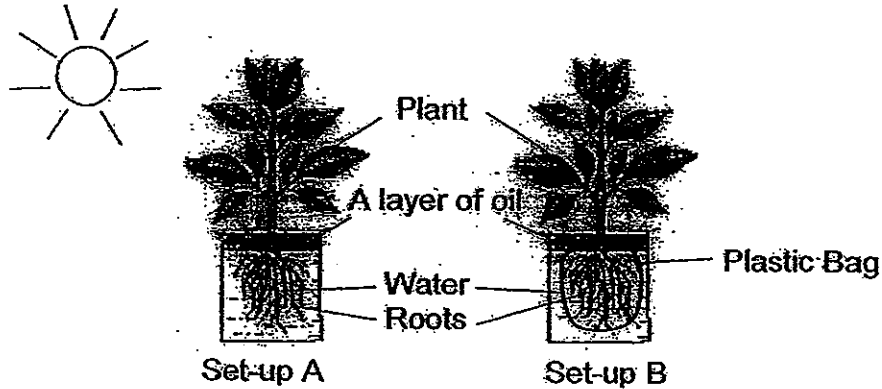

Which one of the following graphs would best represent the change in the amount of water remaining in the beakers in both set-ups after the experiment?

(1)

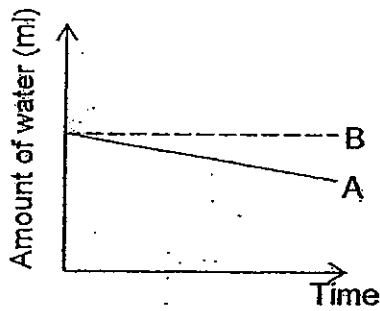

(2)

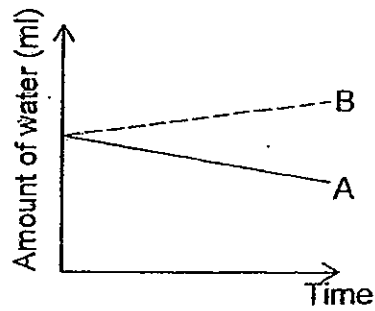

(3)

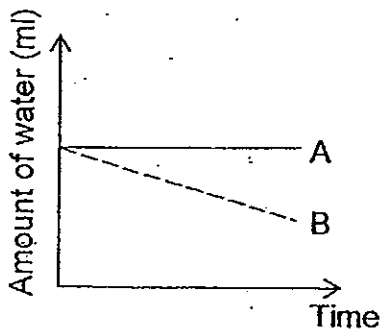

(4)

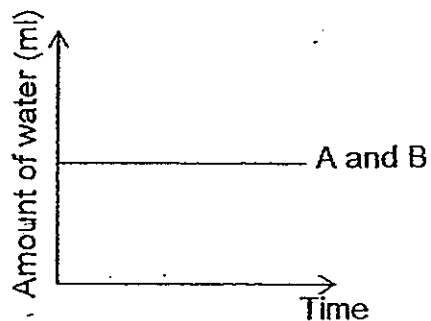

4 Which of the following diagrams indicates the movement of food and water in a plant?

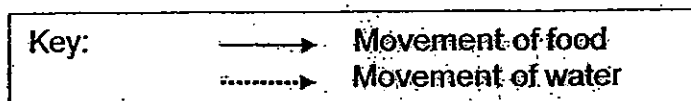

(1)

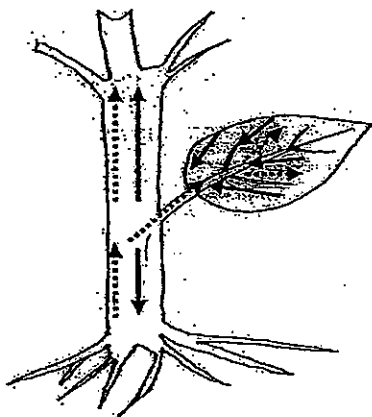

(2)

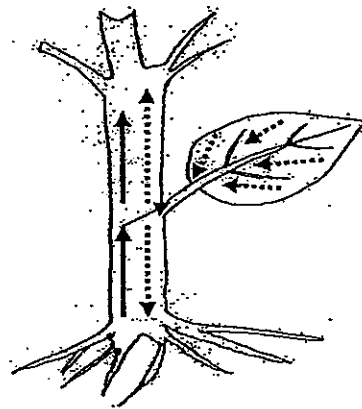

(3)

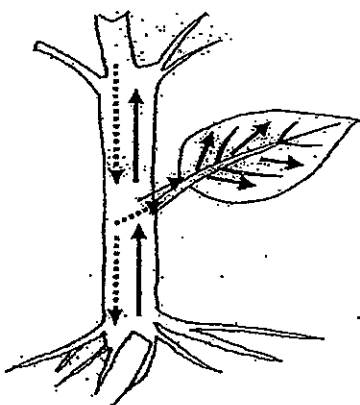

(4)

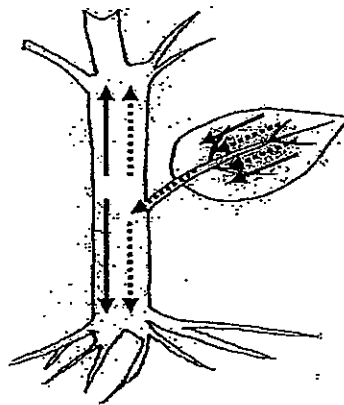

5 The diagram below shows a flowering plant.

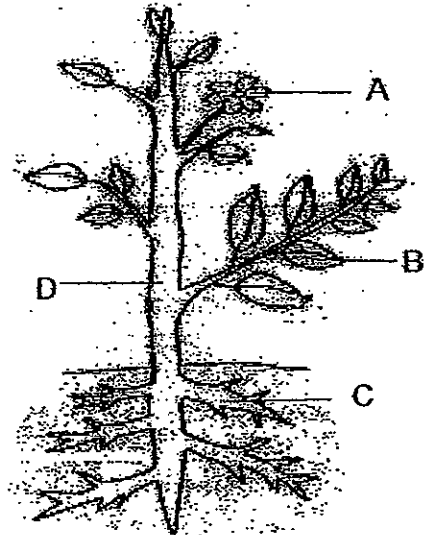

At which parts of the plant can the food-carrying tubes be found?

(1) A and B only

(2) B and D only

(3) A, C and D only

(4) A, B, C and D

- 6 The table below shows the percentage of three gases in a sealed glass tank at the start of an experiment.

Gas	Percentage
Nitrogen	78%
Oxygen	21%
Carbon dioxide	0.04%

The glass tank contained some rats and was placed in a room for a day.

Which one of the following most correctly shows the likely change in percentage of the three gases in the glass tank after 3 hours?

(1)

Gas	Percentage
Nitrogen	unchanged
Oxygen	decrease
Carbon dioxide	increase

(2)

Gas	Percentage
Nitrogen	decrease
Oxygen	increase
Carbon dioxide	unchanged

(3)

Gas	Percentage
Nitrogen	unchanged
Oxygen	increase
Carbon dioxide	decrease

(4)

Gas	Percentage
Nitrogen	increase
Oxygen	decrease
Carbon dioxide	increase

- 7 The diagram below represents the human circulatory system. The blood vessels are represented by the letters, W, X, Y and Z.

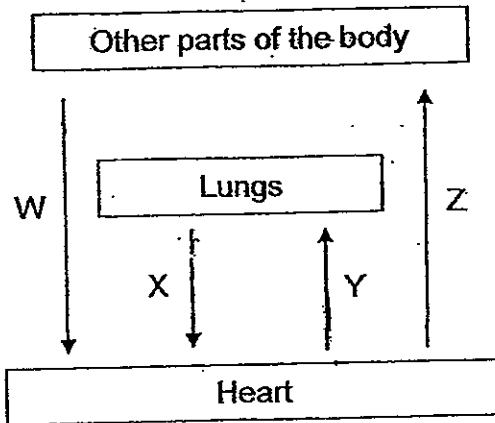

Which two blood vessels carry blood rich in carbon dioxide?

- (1) W and X
 (2) X and Z
 (3) W and Y
 (4) X and Y
- 8 Four tanks were filled with water of different temperatures. A fish was placed in the first tank. Then the amount of oxygen dissolved in the water was measured and the number of gill beats was counted carefully by observing the fish. This was repeated for the rest of the tanks with the same fish. Each time the fish opened and closed the gills, it is one gill beat. The results were shown in the table below.

Water temperature (°C)	Amount of dissolved oxygen per 1000cm ³ of water (cm ³)	Number of gill beats per minute
5	9.15	20
10	8.02	28
15	7.22	33
20	6.57	36

Which of the following statement(s) is/are true based on the results above?

- A The higher the temperature of water, the faster the gills beat per minute.
 B There is more dissolved oxygen in water as the temperature of water increases.
 C The temperature of the water affects the amount of dissolved oxygen in the water.

- (1) A only
 (2) B only
 (3) A and C only
 (4) A, B and C

9. Which one of the following diagrams below correctly shows the direction of the flow of blood in our body?

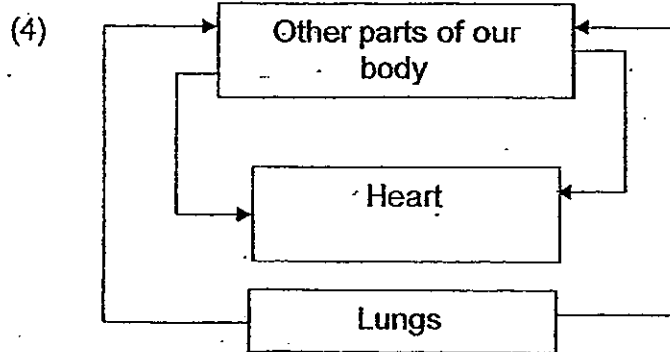
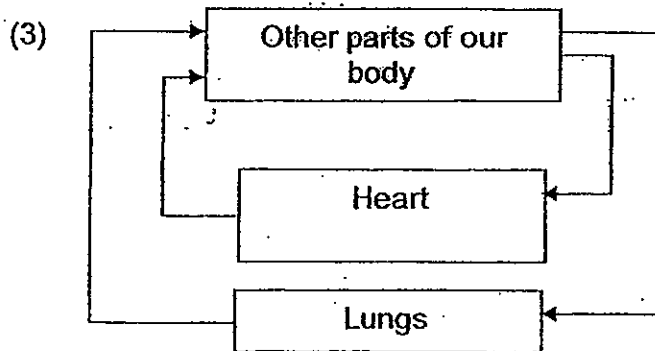
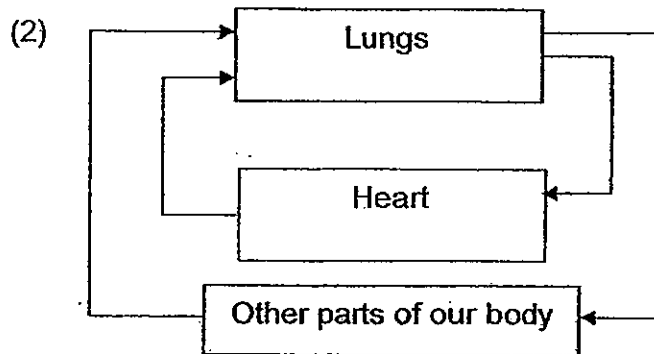
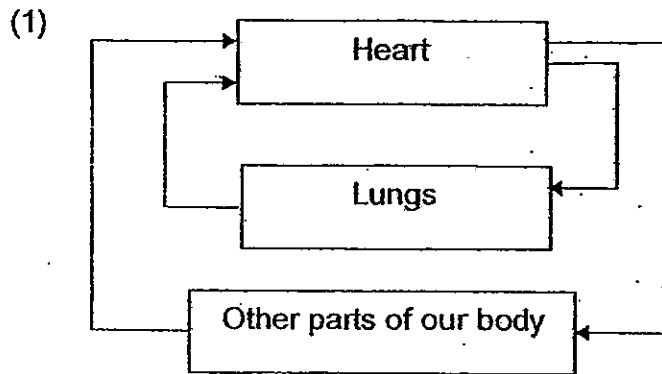

- 10 Study the diagram below which shows how the three systems work together in a human body.

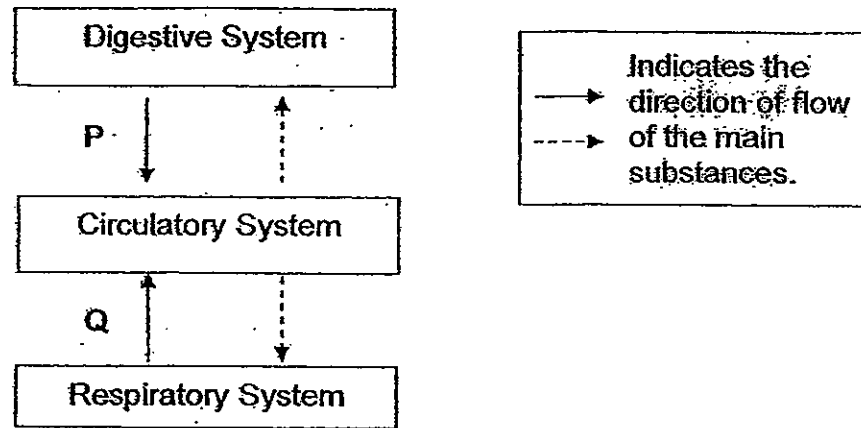

Which of the following do P and Q represent?

	P	Q
(1)	Digested food only	Oxygen
(2)	Digested food only	Oxygen and Carbon dioxide
(3)	Digested food and water	Oxygen
(4)	Digested food and water	Oxygen and Carbon dioxide

- 11 Which sequence correctly describes the flow of energy in our natural environment?

- (1) carnivore → herbivore → plant → Sun
 (2) carnivore → plant → herbivore → Sun
 (3) Sun → carnivore → herbivore → plant
 (4) Sun → plant → herbivore → carnivore

- 12 The clown fish seek protection among the sea anemones in the ocean. What could possibly cause the decline in the population of clown fish?

- A: The water was polluted.
 B: There is no food for the clown fish.
 C: The number of predators of clownfish increased.
 D: The population of sea anemones declined due to disease.

- (1) C only
 (2) A and B only
 (3) A, B and D only
 (4) A, B, C and D

13 Study the food chain below carefully.

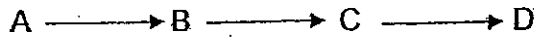

If the population of C is wiped out, which of the following statements is false?

- (1) Population of B increases.
- (2) Population of A increases.
- (3) Population of D decreases
- (4) Population of A decreases

14 The food web shows the food relationship between different animals in a forest.

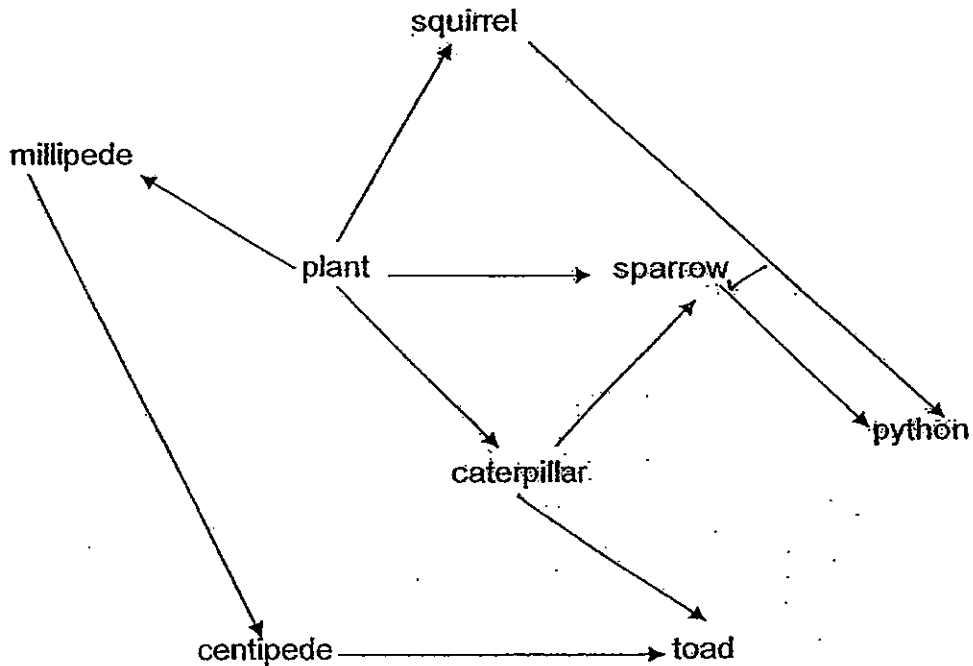

How many organisms are predators as well as prey?

- (1) 2
- (2) 3
- (3) 4
- (4) 5

15 Study the food web carefully.

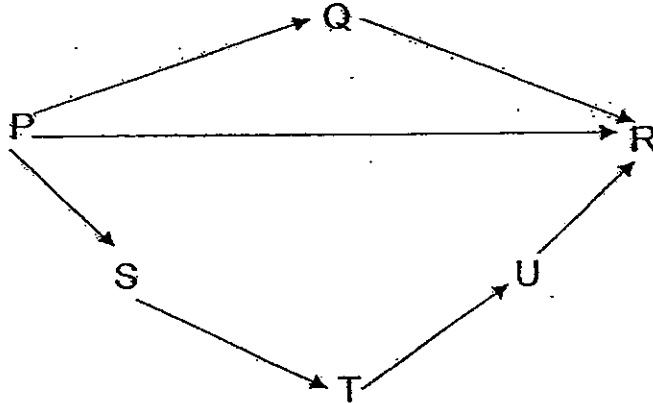

- A: S is a consumer.
- B: If R and S are removed, T will decrease.
- C: R is likely to be an omnivore.
- D: P and T are producers.

Which of the above statements about the community in the food web are true?

- (1) A and B only
- (2) C and D only
- (3) A, B and C only
- (4) B, C and D only

16 The diagrams below show the beaks of 4 different birds, A, B, C and D.



Which one of the following is correctly matched to the diet of the 4 birds?

	A	B	C	D
(1)	mice	nectar	nuts	seeds
(2)	insects	fish	small crab	mice
(3)	fish	insects	seeds	berries
(4)	fish	nectar	mice	seeds

17 A camel is well adapted to live in the desert.

A : Humps that store large amounts of water.

B : Padded feet that shield its feet from the hot ground.

C : Long eye lashes that prevent sand from being blown into its eyes.

Which of the following statements are true about the camel?

(1) A and B only

(2) A and C only

(3) B and C only

(4) A, B and C

18 Which one of the following statements correctly describes the structural adaptation of animals?

(1) Migratory birds travel long distances to warmer regions.

(2) The grizzly bears eat a lot before hibernating during winter.

(3) The stripes on zebras distract their predators when they move in groups.

(4) The caterpillars coil up under green leaves to blend in with their surroundings.

19 Which one of the following actions is the best way to reduce air pollution?

(1) Plant more trees

(2) Drive within speed limits

(3) Use incinerators to burn rubbish

(4) Use public transport instead of driving

- 21 Study the four electric circuits as shown below. All the batteries in the circuits have the same voltage and the bulbs are of the same size and voltage.

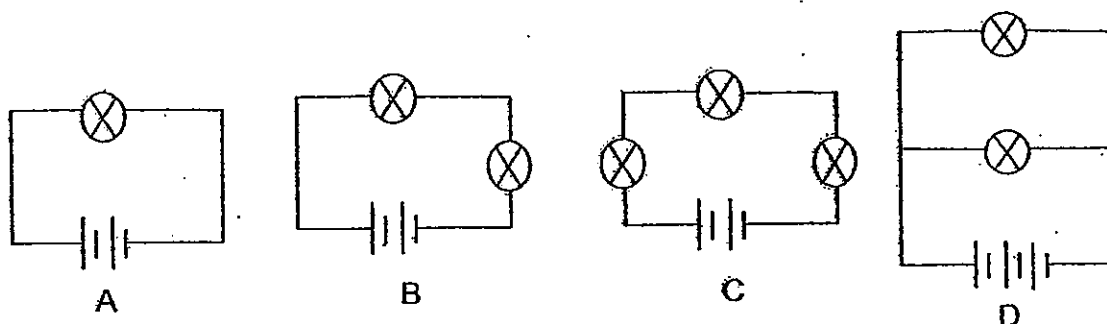

Arrange the electric circuits A, B, C and D, starting with the circuit with brightest bulb(s).

- (1) D, A, B, C (2) A, B, C, D
 (3) D, C, B, A (4) A, B, D, C

- 22 Study the electric circuit below.

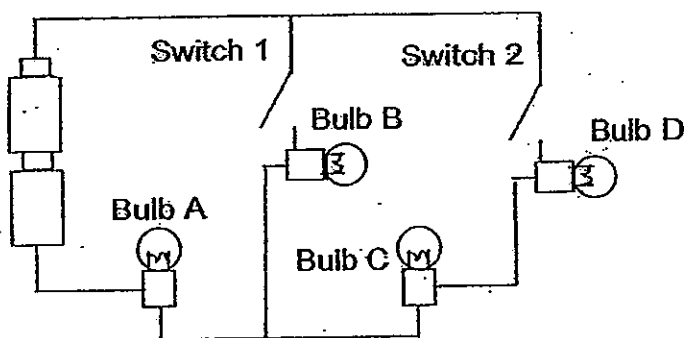

Which of the following correctly shows the bulbs that will light up when the switches are closed one at a time?

	Only when Switch 1 is closed	Only when Switch 2 is closed
(1)	Bulbs A and B	Bulbs C and D
(2)	Bulbs A and B	Bulbs A, C and D
(3)	Bulbs A and C	Bulbs A, C and D
(4)	Bulbs B, C and D	Bulbs B, C and D

23 The diagram below shows five bulbs connected by two batteries.

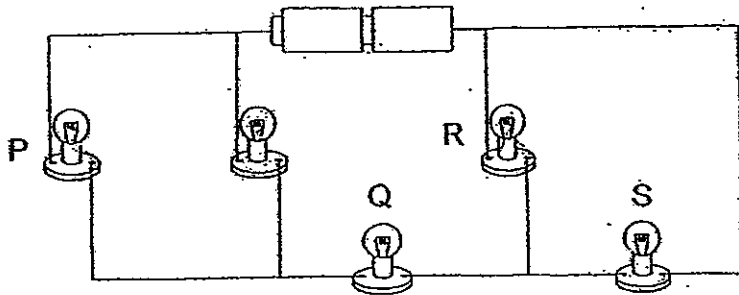

One of the four bulbs (P, Q, R or S) is not working and as a result, none of the bulbs light up. Which bulb is not working?

- (1) P
- (2) Q
- (3) R
- (4) S

24 Gary wanted to install four lamps in his house. However, he wanted to ensure that the lamps can lit up independently. Which of the following circuits should he use?

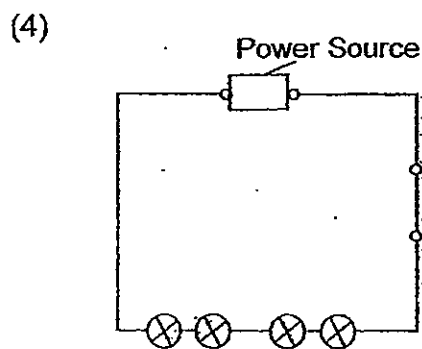
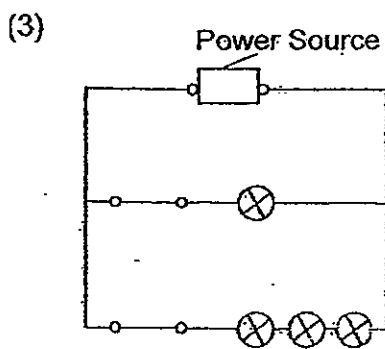
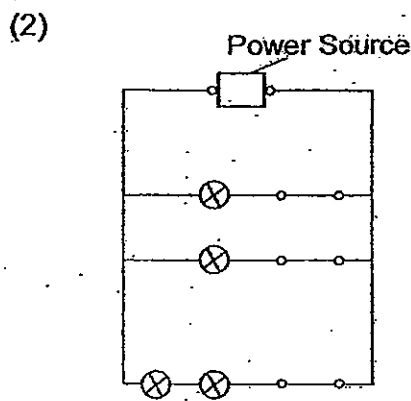
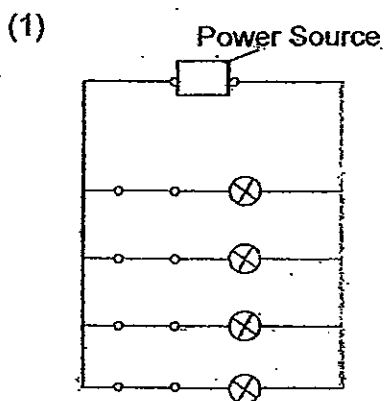

- 25 The diagram below shows 4 bulbs C, D, E and F in a circuit that is connected correctly.

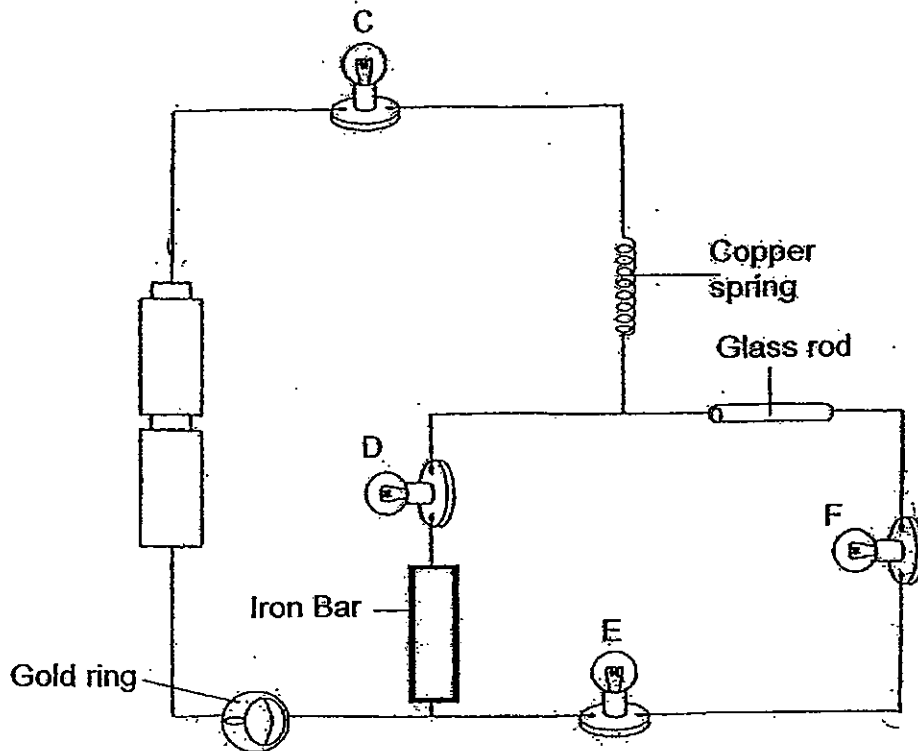

Which of these bulbs will not light up?

- | | |
|------------------|-------------------|
| (1) C and D only | (2) E and F only |
| (3) C, E, F only | (4) C, D, E and F |

28 The flow chart below is used to classify forces A, B, C and D.

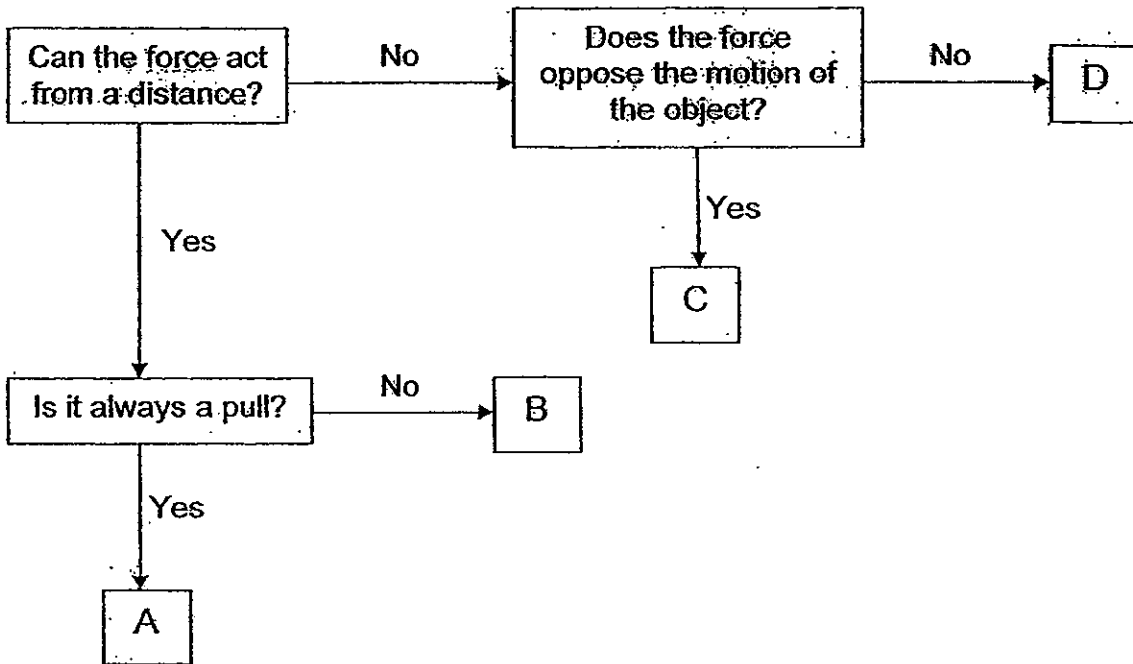

Which one of the following are the 4 forces identified correctly?

	A	B	C	D
(1)	Gravity	Magnetic Force	Push	Friction
(2)	Gravity	Magnetic Force	Friction	Push
(3)	Magnetic Force	Gravity	Friction	Push
(4)	Magnetic Force	Gravity	Push	Friction

29 Anusha used more effort carrying books up the stairs than down the stairs. Which of the following force(s) acted on her when she went up the stairs?

- A: Frictional force
- B: Magnetic force
- C: Gravitational force

- (1) A only
- (2) C only
- (3) A and C only
- (4) A, B and C

30 Study the diagram below.

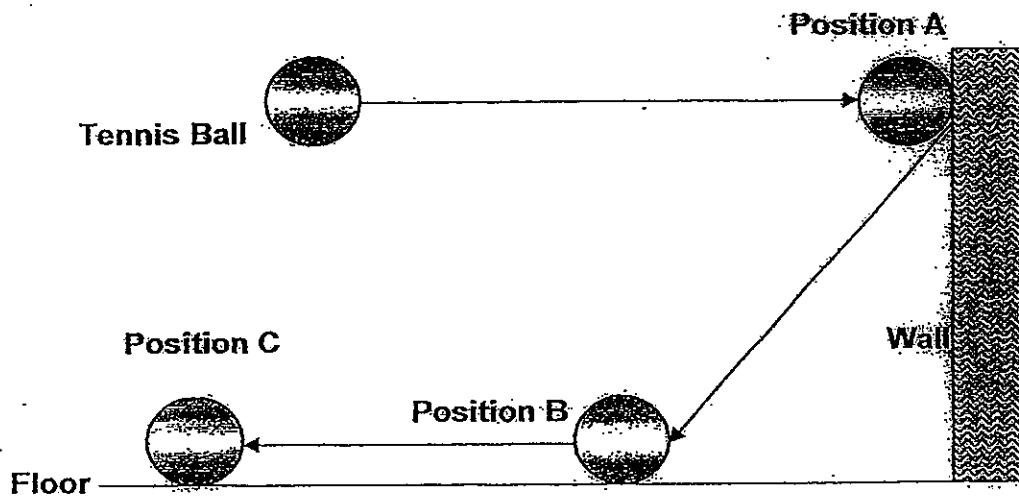

When Dennis threw a tennis ball against the wall, it hit the wall at position A and bounced off and landed on the floor at position B. It then rolled along the floor and finally stopped at position C.

What were the forces acting on the tennis ball when it moved from Position A to Position B?

- (1) Push and frictional forces
- (2) Frictional and magnetic forces
- (3) Gravitational and frictional forces
- (4) Magnetic and gravitational forces

End of Booklet A



Rosyth School
Semestral Examination for 2012
STANDARD SCIENCE
Primary 5

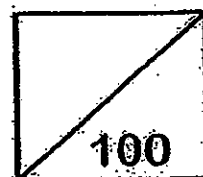

Total
Marks:

Name: _____

Class: Pr 5- _____ Register No. _____ Duration: 1 h 45 min

Date: 30 October 2012 Parent's Signature: _____

Booklet B

Instructions to Pupils:

1. For questions 31 to 44, write your answers in the spaces given in this booklet.

	Maximum	Marks Obtained
Booklet A	60 marks	
Booklet B	40 marks	
Total	100 marks	

* This booklet consists of 14 pages.

Part II (40 marks)

For questions 31 to 44, write your answers in this booklet. The number of marks available is shown in brackets [] at the end of each question or part question.

31 The diagrams below show a tree and a chicken.



Tree



Chicken

(a) State one similarity between the cells in both organisms. [1]

(b) Both organisms are made up of many cells and they divide to form new cells. Give two reasons why they have to form new cells. [2]

(i) _____

(ii) _____

32 The diagram below shows a seedling with its root growing out.



After several days, the root became longer.



(a) What happens to the cells in the root as the root grows in length? [1]

Glenda observed the root cells of the seedling under the microscope. The diagram below shows the image of a root cell.

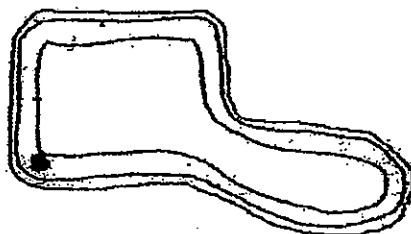

(b) Which part is missing in the root cell that can be found in a green leaf cell? [1]

(c) Explain why the cell part in (b) cannot be found in the root cell. [1]

33 The diagram below shows the human respiratory system.

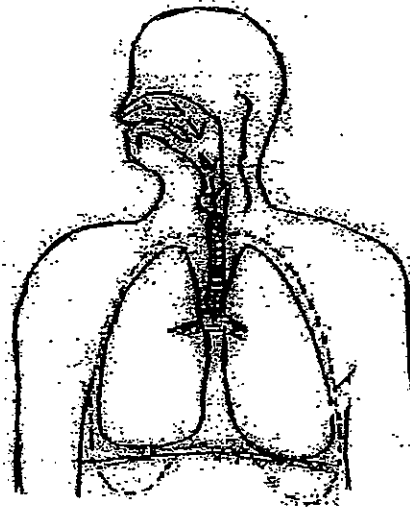

(a) When we breathe in, many gases enter our body. Identify the gas that our body needs. [1]

(b) Using arrows, draw how air enters our lungs on the diagram above. [1]

(c) When we exercise, we will breathe faster. Explain why this is so. [2]

- 34 Fahim conducted an experiment to find out how a person's heart rate will affect the body temperature during exercise. He presented the results in the graphs below.

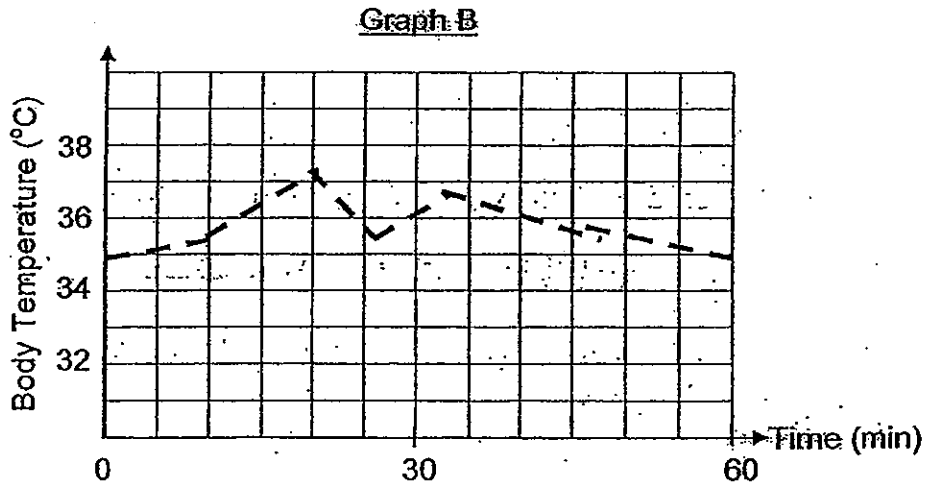
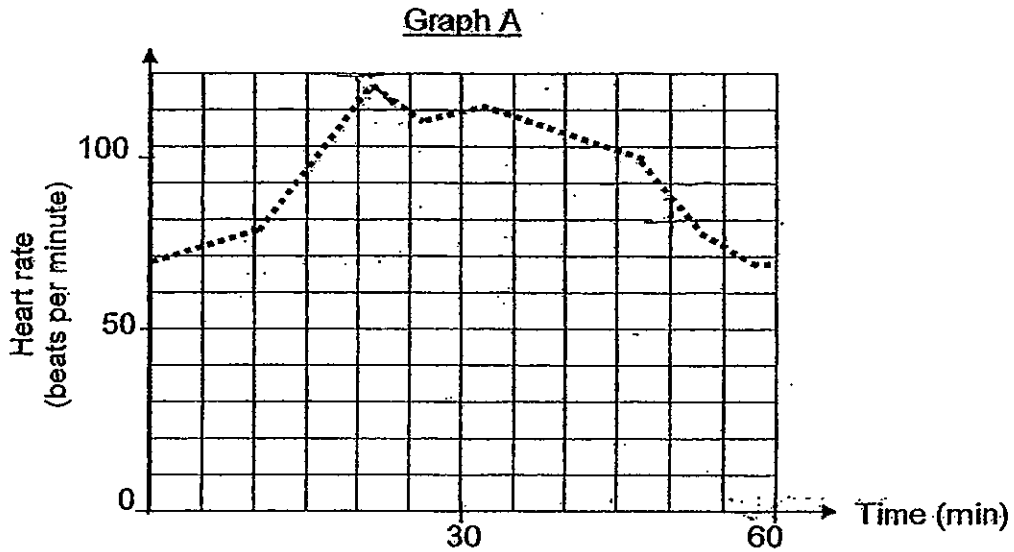

- (a) Based on the above graphs, what is the relationship between the heart rate and body temperature of a person? [1]

- (b) Put an 'X' on graph A to show when the person is likely doing the most vigorous activity. [1]

- 35 Razif set up the experiment in a dark room to find out how the rate of photosynthesis is affected by the distance between the light source and the beaker.

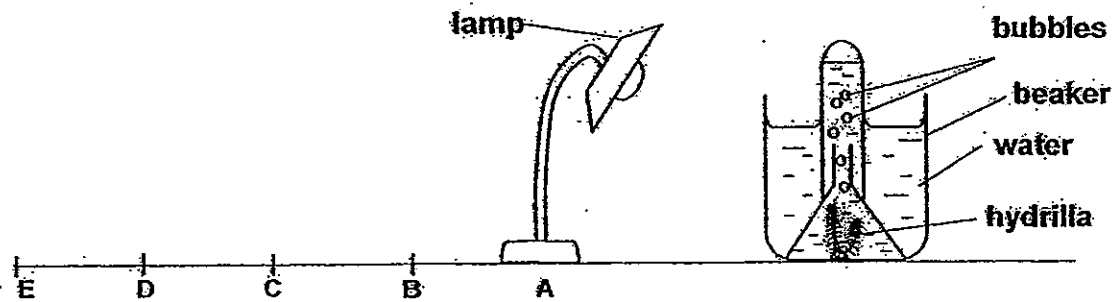

The table lamp was placed at different distances from the beaker as shown by the positions A to E and the number of bubbles produced per minute by the hydrilla was recorded.

After the experiment, Razif plotted a graph below to show the results.

- (a) On the graph below, label the vertical and horizontal axes by filling in the boxes provided. [2]

(i)

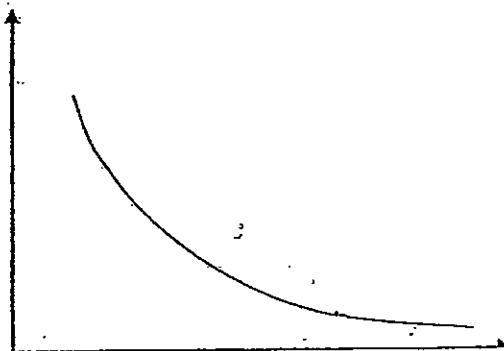

(ii)

- (b) What conclusion can Razif draw from the graph as shown above? [1]

- 36 Karen set up 3 similar beakers, A, B and C, as shown in the diagram below. The 3 beakers were placed in the same location. She added the same amount of tap water and the same number of tadpoles in each beaker. She added 4 grams of pesticide X in beaker B and 4 grams of pesticide Y in beaker C.

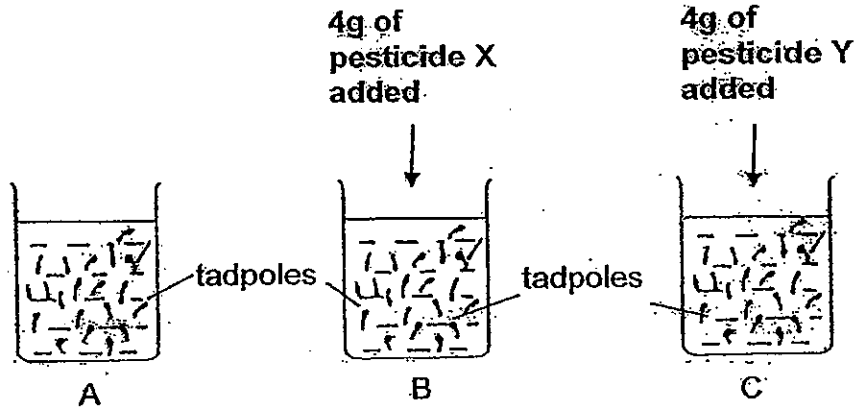

After 2 days, she recorded the results in the table below.

Beaker	Original number of live tadpoles	Number of live tadpoles after 2 days
A	25	25
B	25	8
C	25	10

- (a) Which pesticide is more harmful? Explain your answer. [1]

- (b) Why is there a need to set up Beaker A? [1]

37 The diagram below shows a food web.

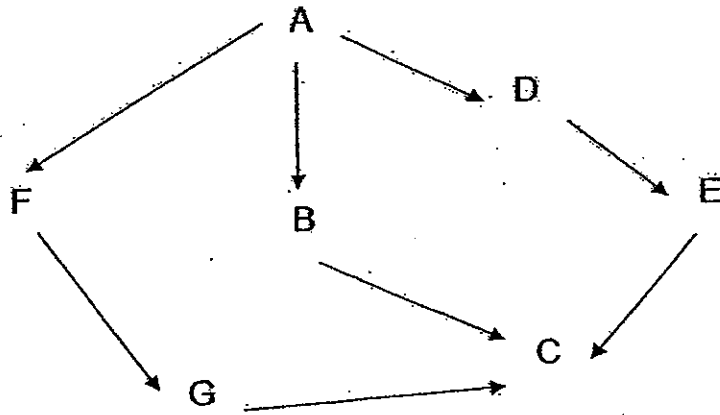

Put a tick (✓) in the correct boxes to show whether the statements given are 'True', 'False' or 'Not Possible to Tell'. [3]

	True	False	Not Possible to Tell
a) Organism A gets energy directly from F.			
b) Organism E is a herbivore.			
c) Organisms A, B, D and E can form a food chain.			
d) Organism C prefers eating organism B to organism E.			
e) Organism A gets its food from 3 other organisms.			
f) If the population of organism C decreases, the population of organism D will decrease.			

38 The diagram below shows a leaf insect and a tortoise. Both animals have ways in which they protect themselves from their predators.



leaf insect

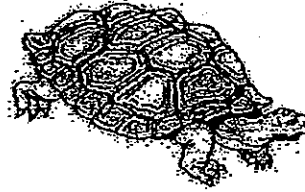

tortoise

Write the structural adaptation of each animal that helps them escape from their predators. [2]

Leaf insect:

Tortoise:

39 The picture below shows an industrial town.

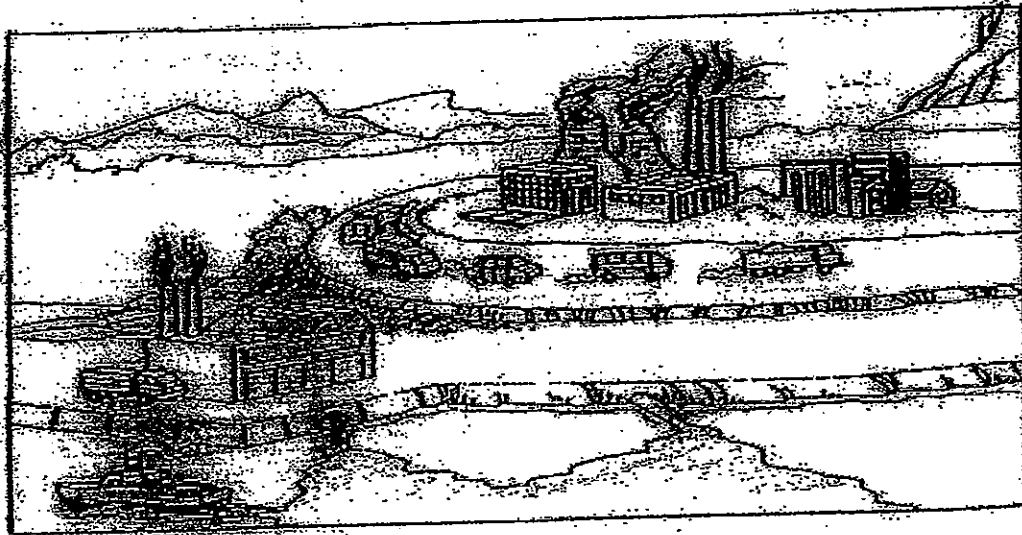

Complete the table with the type of pollutions and the possible effect of that pollutant to the environment. [4]

	Type of pollution	Examples of Man's action	Possible effect of Pollutant
(i)		Dumping of untreated sewage	
(ii)		Burning of fossil fuels	

- 40 The diagram below shows a game which requires one to move a metal loop through a length of curved wire. The game tests the steadiness of the player's hand. If the player's hand is not steady and the loop touches the curved wire, the bulb will light up.

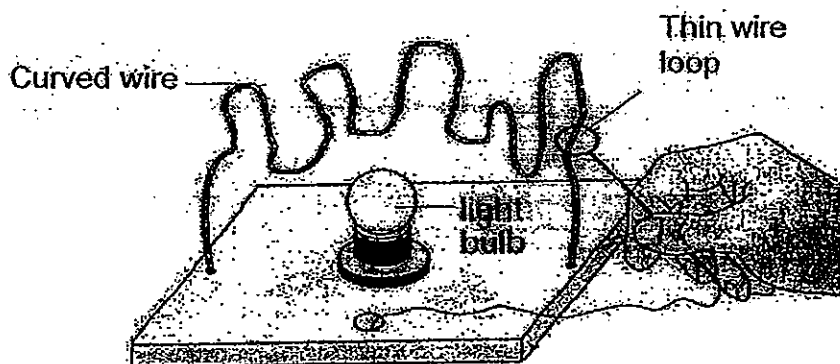

- (a) What property should the thin wire loop have in order for it to be used in this game? [1]

- (b) Why does the bulb light up when the loop touches the curved wire? [1]

41 Ronald wanted to set up an electric circuit for his toy house. He wanted to arrange the bulbs in series.

- Three bulbs
- Some wires
- One battery
- One switch

(a) Using the items above, draw the circuit diagram that Ronald had set up. [2]

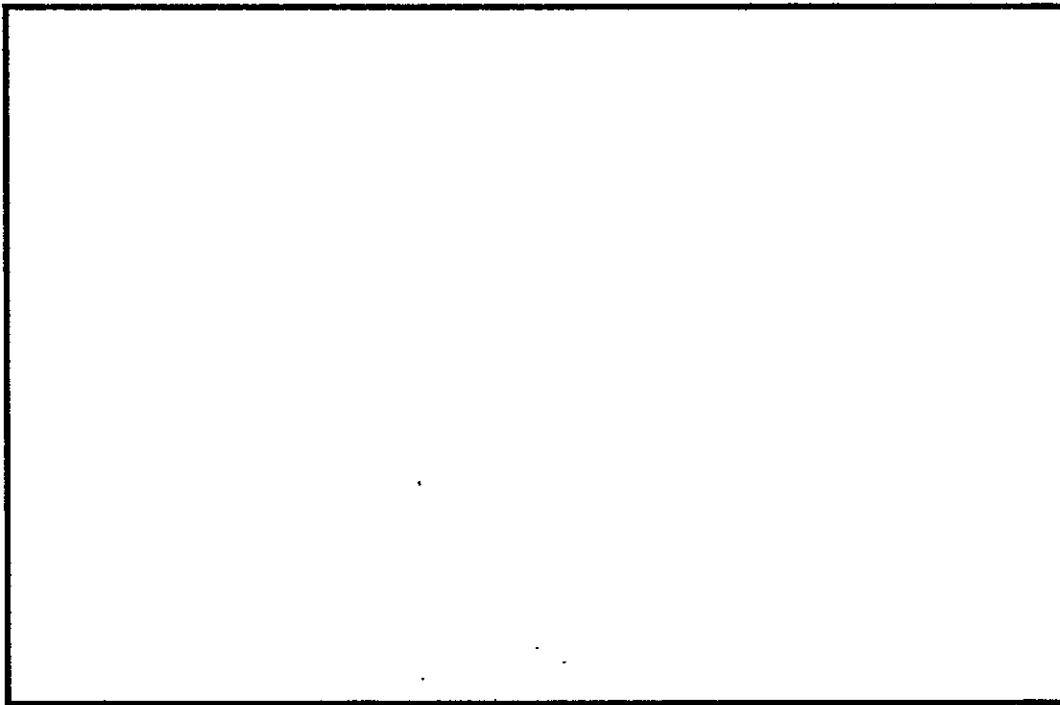

(b) What is the function of the switch in the circuit? [1]

(c) What will happen to the brightness of the bulbs if there are only two bulbs in series? [1]

- 42 Brenda carried out an experiment using three rods of different materials, E, F and H in the set-up below. The rods were of the same thickness and size.

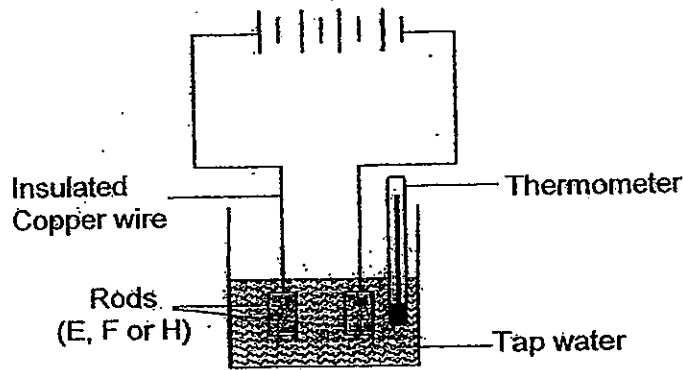

She connected the rods to the circuit and measured the temperature of the water every five minutes. The experiment was repeated for the other two materials. The tap water was changed and new batteries were used each time.

The results were shown in the table below.

Time (min)	Temperature of water (°C)		
	Rod E	Rod F	Rod H
0	28	28	28
5	28	31	32
10	30	32	34
15	31	34	36
20	32	34	37

- (a) What is the aim of the experiment? [1]
-
-
- (b) Name two fixed variables of the experiment, other than the thickness and length of the wires. [1]
-
-
- (c) Without changing to another material, what can Brenda do to the set-up to make the water warmer? [1]
-
-

- 43 The picture below shows David pulling a 50 kg load up a slope.

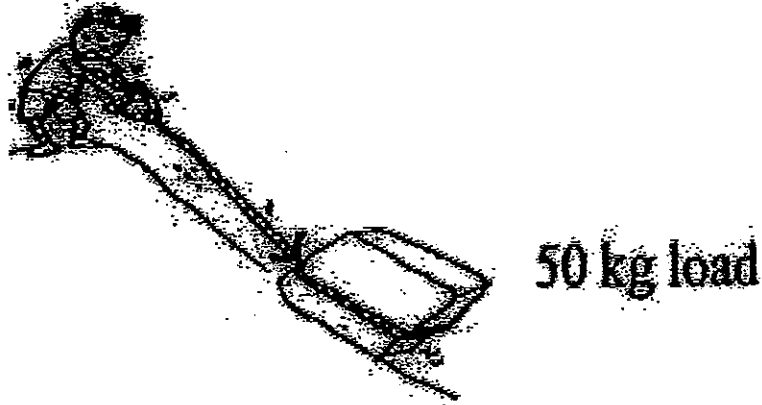

- (a) Apart from the pulling force, what are the other 2 types of forces acting on the 50 kg load? [2]

- (b) Suggest one way for David to pull the 50 kg load by himself up the slope using less force. [1]

- 44 Different glass blocks A, B, C and D were placed one by one and pulled back to the same starting distance. The different glass blocks were then released separately and made to move over a piece of marble block in an experiment shown below.

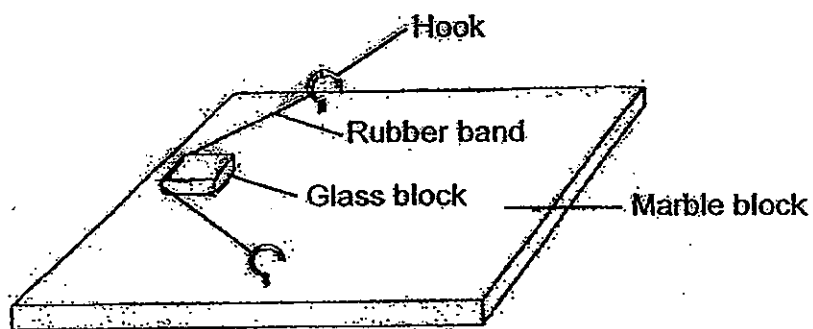

The distance moved by the glass block each time is recorded in a table below.

Glass block	Distance moved (cm)
A	42
B	26
C	18
D	33

- (a) Arrange the four glass blocks in ascending order of their ability to reduce friction. [1]

- (b) Name a variable in this experiment that is kept constant in order to carry out a fair test. [1]

End of Paper

ANSWER SHEET

EXAM PAPER 2012

SCHOOL : ROSYTH
SUBJECT : PRIMARY 5 SCIENCE

TERM : SA2

Q1	Q2	Q3	Q4	Q5	Q6	Q7	Q8	Q9	Q10	Q11	Q12	Q13	Q14	Q15	Q16	Q17
2	2	1	1	4	1	3	3	1	3	4	4	2	1	3	4	3

Q18	Q19	Q20	Q21	Q22	Q23	Q24	Q25	Q26	Q27	Q28	Q29	Q30
3	4	2	1	2	2	1	2	1	2	2	2	3

- 31)a)Both the cells have a nucleus.
b)i)To repair and replace dead cells.
ii)For growth.

- 32)a)The cells divide.
b)The chloroplasts.
c)Chloroplasts contain chlorophyll that helps to photosynthesis in the leaves.
Whereas the root cell does not make food, so it does not have chloroplasts.

- 33)a)Oxygen.
b)

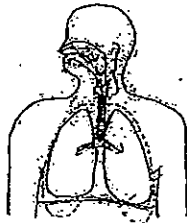

- c)We need take in more oxygen so that we have more energy to exercise.

34)a)The higher the heart rate, the higher the body temperature of a person.

b)

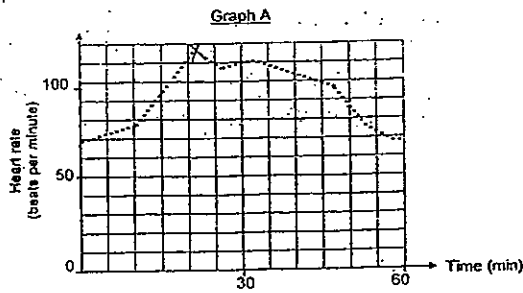

35)a)i)Distance of the table lamp from the beaker.

ii)Number of bubbles produced per minute by the hydrilla.

b)The distance between the light source and beaker affects the rate of photosynthesis.

36)a)Pesticide X. There were a lesser number of live tadpoles in B after 2 days.

b)To prove that the type of pesticide is the only variable that affects the number of live tadpoles.

37)a)F b)F c)F d)Not e)F f)T

38)a)It's body looks like a leaf that helps it to blend in with the leavers.

b)A hard shell to protect itself from its predators.

39)i)Water pollution / loss of habitats. Marine animals may die.

ii)Air pollution / Causes greenhouse effects that results in global warming.

40)a)It should be made of a material that conducts electricity.

b)When the loop touches the wire, it closes the circuit and electric current can pass through the circuit.

41)a)

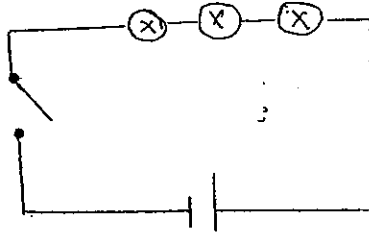

b)To control the flow of electricity passing through the circuit.

c)The brightness of the bulb will increase.

42)a)To find out which material is a better conductor of electricity.
b)The number of batteries and the arrangement of batteries.
c)Add more batteries.

43)a)Gravitational force and frictional force.
b)David could attach rollers or wheels to pull the 50kg load by himself up the slope using less force.

44)a)C, B, D, A
b)The elasticity of the rubber band.

