

CATHOLIC HIGH SCHOOL
PRIMARY 5
SEMESTRAL EXAMINATION 2
2012

SCIENCE

Name: _____ ()

Class : Primary 5 _____

Date : 25 October 2012

BOOKLET A

30 Questions
60 Marks

Total Time for Booklets A & B : 1 hour 45 minutes

Instructions to Candidates

Do not open this booklet until you are told to do so.
Follow all instructions carefully.
Answer all questions.



Section A : Multiple Choice Questions (60 marks)

For each question from 1 to 30, four options are given. One of them is the most suitable answer. Make your choice (1, 2, 3 or 4) on the Optical Answer Sheet.

1. Which one of the following statements is true about green plants?

- (1) Green plants do not make food.
- (2) All green plants respond to sunlight.
- (3) All green plants depend on animals for food.
- (4) Green plants can only reproduce from seeds.

2. The diagram below shows the life cycle of a cockroach and a mealworm beetle.

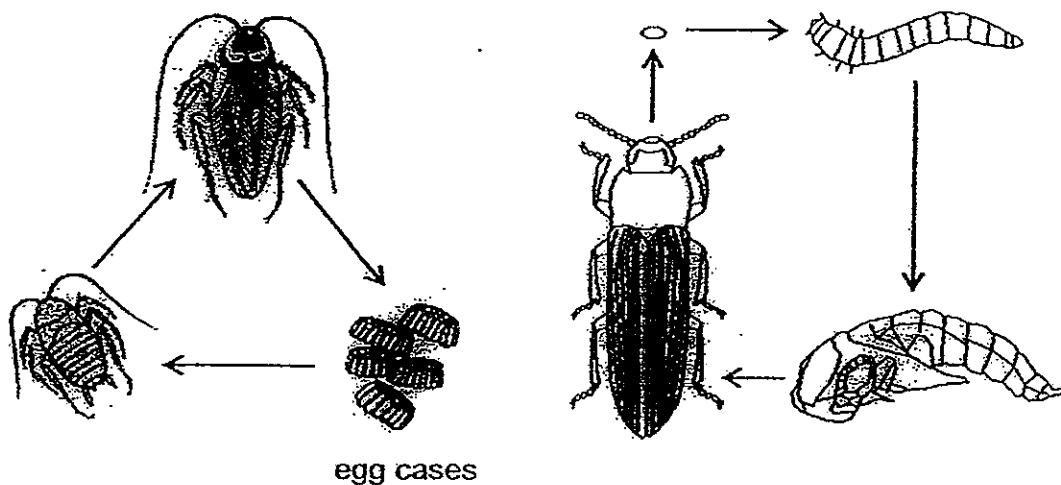

Life cycle of a cockroach

Life cycle of a mealworm beetle

Based on the life cycles above, what is the difference between the life cycle of a cockroach and a mealworm beetle?

- (1) The cockroach goes through moulting but the mealworm beetle does not.
- (2) The cockroach lays its eggs on land while the mealworm beetle lays its eggs in water.
- (3) The cockroach has a two-stage life cycle but the mealworm has a three-stage life cycle.
- (4) The young of a cockroach resembles its parent but the young of a mealworm does not resemble its parent.

3. Which one of the following flowcharts below best represents the path taken by the food we eat?

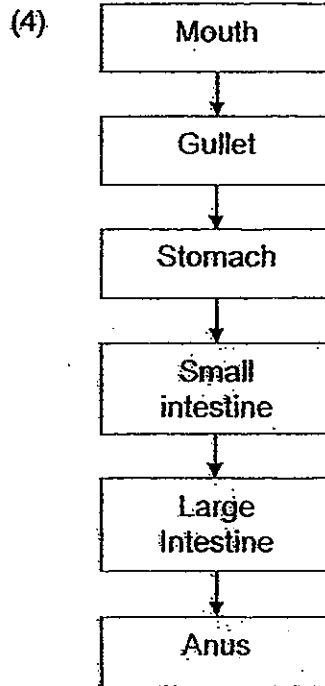
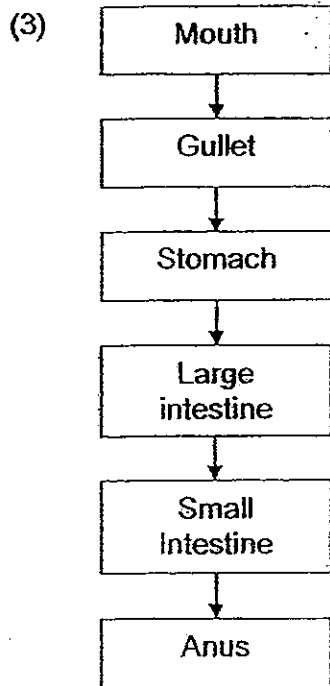
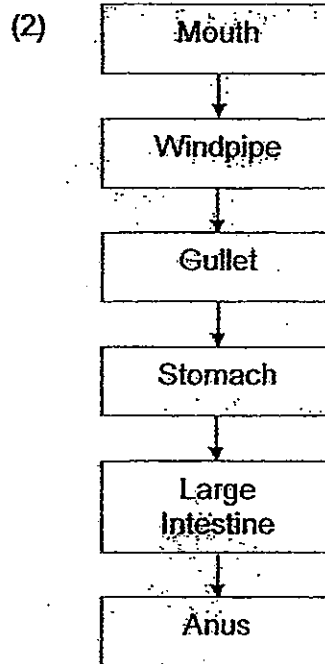
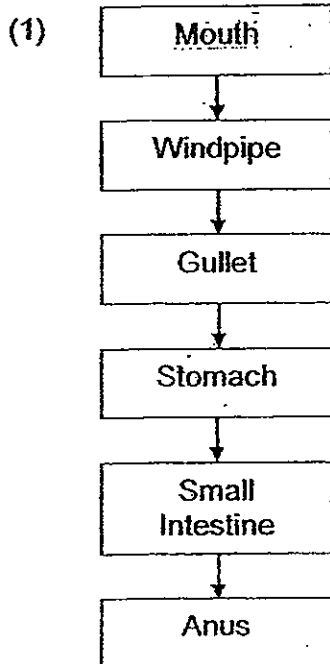

4. The diagram below shows the stages in the life cycle of a flowering plant. A and B represent the processes that take place between each stage of the life cycle.

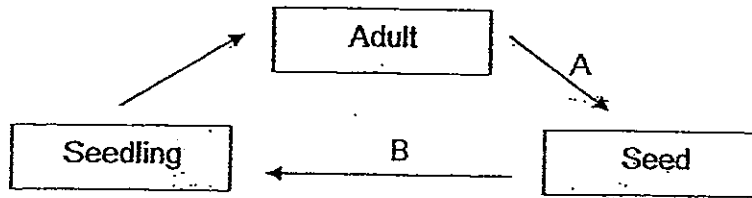

Which one of the following correctly represents processes A and B?

	A	B
(1)	pollination	fertilisation
(2)	fertilisation	pollination
(3)	fertilisation	germination
(4)	germination	pollination

5. Jerome carried out the following steps in an experiment.

- Step 1: He filled five flower pots made of the same material but of different sizes with the same amount of garden soil.
 Step 2: He planted five of the same type of seeds in each pot.
 Step 3: He placed the pots next to one another in the garden.
 Step 4: He watered the pots with the same amount of water daily.

Jerome is trying to find out if _____.

- (1) sunlight is necessary for photosynthesis
- (2) overcrowding affects healthy plant growth
- (3) water is necessary for healthy plant growth
- (4) the number of seeds affects the rate of photosynthesis

6. Alfred wanted to conduct an experiment to show that plants respire in the dark. He set up the experiment in a brightly-lit room as shown below.

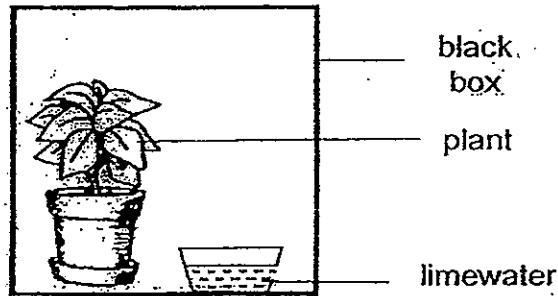

Which one of the following set-ups should he use as a control?

(1)

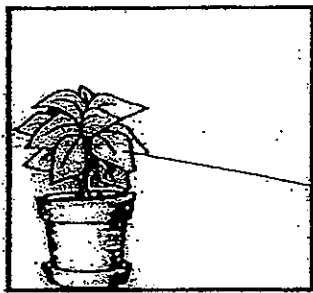

(2)

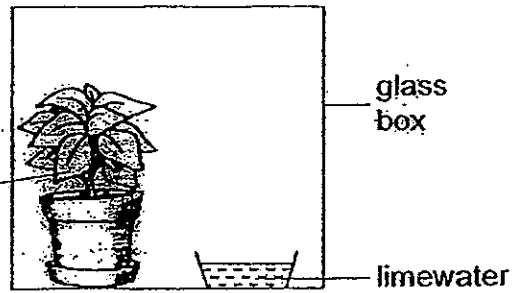

(3)

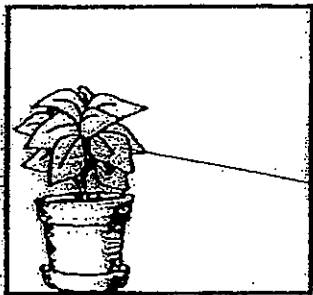

(4)

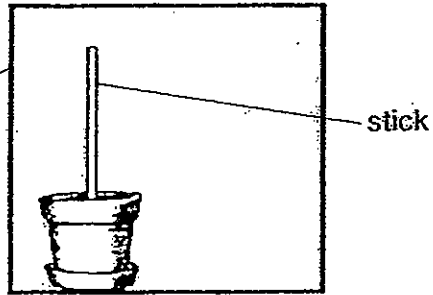

7. The graph below shows the changes in Alexander's breathing rate when he was walking. Soon after he started running.

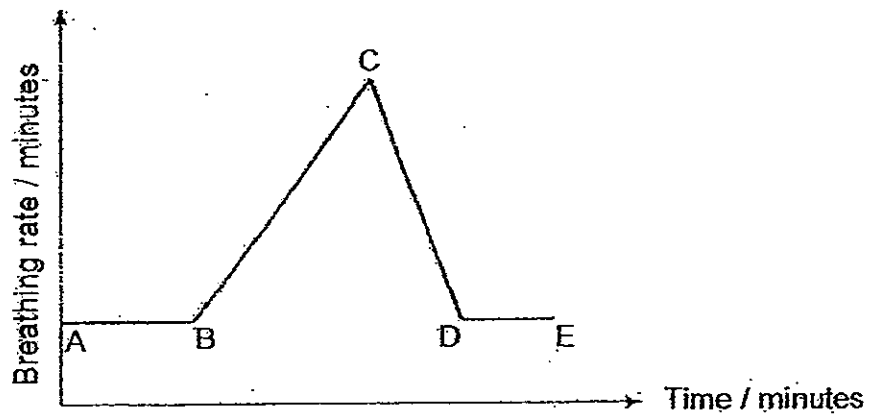

Which part of the graph represents his breathing rate just after he stopped running?

- (1) AB
- (2) BC
- (3) CD
- (4) DE

8. Study the diagrams below carefully.

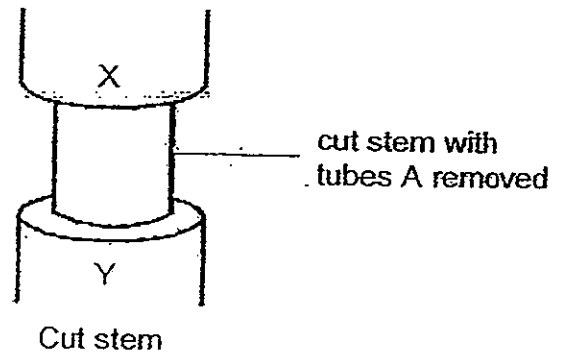
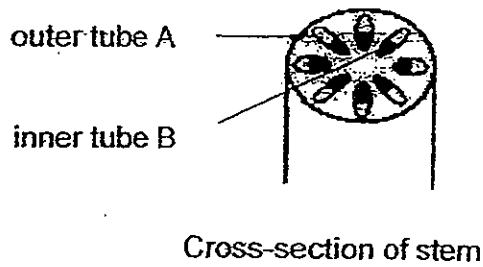

The cross-section of the stem of a plant shows two different sets of tubes, A and B. If the stem is cut in such a way that only the outer tubes A are removed as shown above, which one of the diagrams below show what will happen to that section after three days?

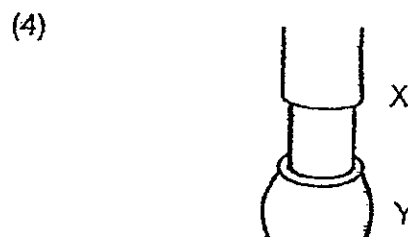
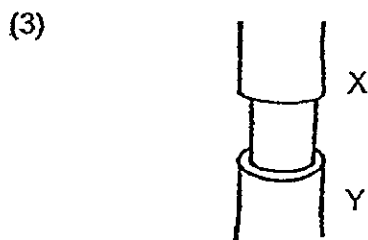
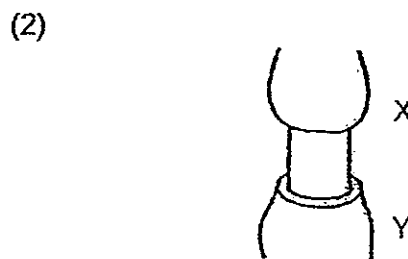
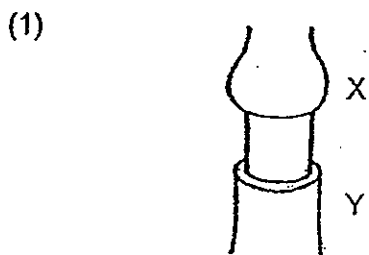

9. The diagram below shows the blood vessels in a human circulatory system.

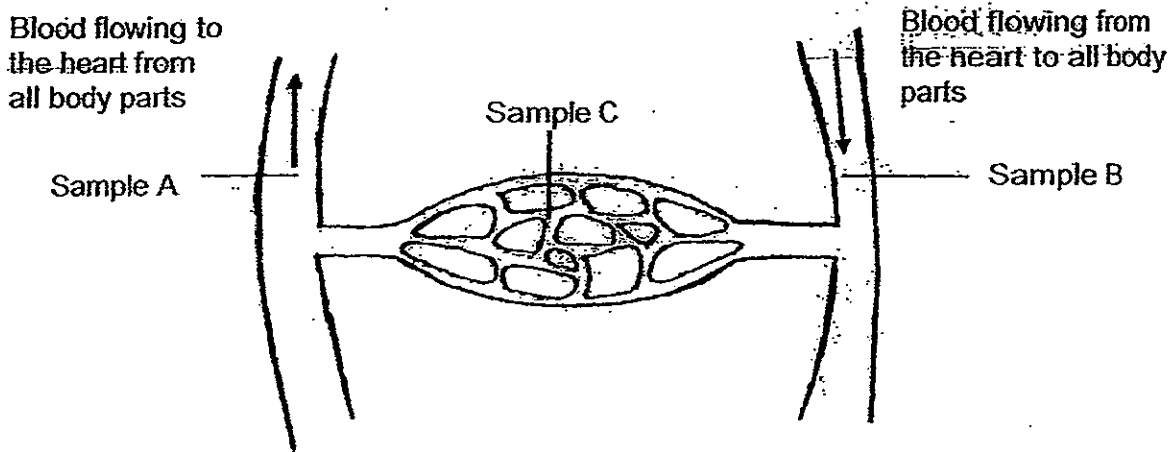

Blood samples, A, B and C, were taken from different blood vessels in the body. Which one of the following bar graphs shows the amount of oxygen in the blood samples?

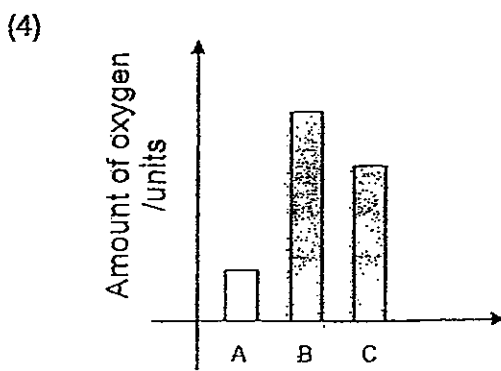
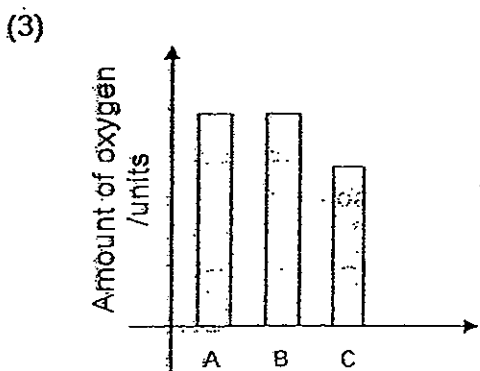
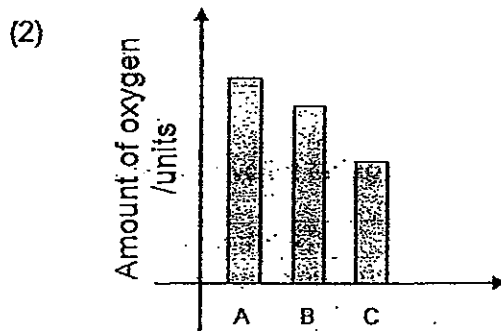
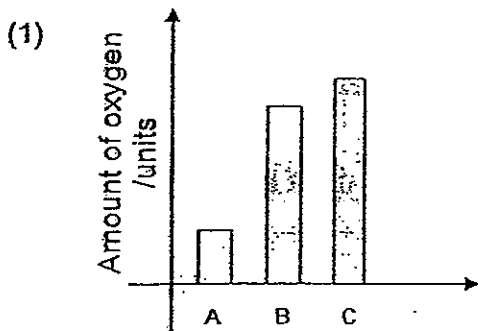

10. Rosnah left three similar pots of plants in a dark room for three days and watered them daily. She then put the pots of plants in the three set-ups shown below and left them in an open field in the afternoon. The solution in each set-up served different functions.

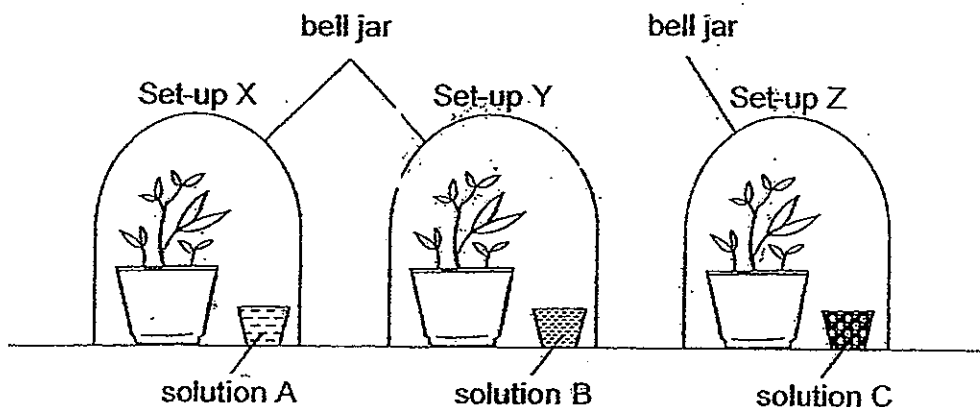

After 6 hours, Rosnah removed a leaf each from the set-ups X, Y and Z and labelled them as X, Y and Z. She conducted a starch test on each of the leaves and recorded the results below.

Leaf	Colour of iodine
X	dark blue
Y	dark blue
Z	brown

Which of the following would solutions A, B and C most likely be?

	Solution A	Solution B	Solution C
(1)	chemical that absorbs carbon dioxide	water	chemical that absorbs oxygen
(2)	chemical that absorbs water vapour	chemical that absorbs oxygen	vinegar with baking soda to produce carbon dioxide
(3)	water	vinegar with baking soda to produce carbon dioxide	chemical that absorbs carbon dioxide
(4)	vinegar with baking soda to produce carbon dioxide	chemical that absorbs water vapour	water

11. Andy coated the stem and both sides of all the leaves of a plant with a layer of oil. One week later, he noticed that the plant had turned yellow and died. This happened because the plant was unable to _____

- A take in oxygen for respiration
- B take in carbon dioxide for photosynthesis
- C take in water vapour from the surrounding air
- D absorb light energy from the sun to photosynthesise

- (1) D only
- (2) A and B only
- (3) A, B and D only
- (4) B, C and D only

12. The table below compares the parts between Cells X and Y.

	Cell X	Cell Y
nucleus	absent	present
cell wall	absent	present
chloroplast	absent	present
cell membrane	present	present

Based on the information provided in the table, which statements are true?

- A Cell Y does not have a regular shape.
- B Cell X is unable to make its own food.
- C Both cells allow some substances to enter and exit.
- D The part of the cell which contains the genetic information of the cell is absent in Cell X but is present in Cell Y.

- (1) A and B only
- (2) A and C only
- (3) A, B and D only
- (4) B, C and D only

13. The diagram below shows the cross-section of a flower.

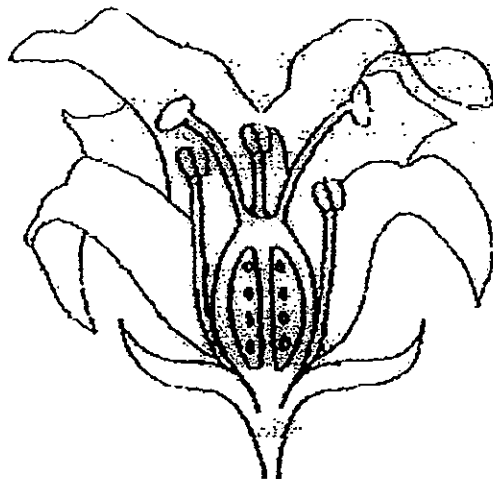

Based on the diagram, which of the following statement(s) about the flower is/are correct?

- A It has only male reproductive parts.
 - B The fruit of the plant has more than four seeds.
 - C The petals will drop off after the pollination process.
 - D The pollen grains used for fertilisation are transferred from another flower.
- (1) B only (1)
(2) A and D only
(3) B and C only
(4) B, C and D only

14. Some students observed three species of plants growing in an open field as show in Diagram 1. Six months later, the students observed the same plants and recorded the changes as shown in Diagram 2.

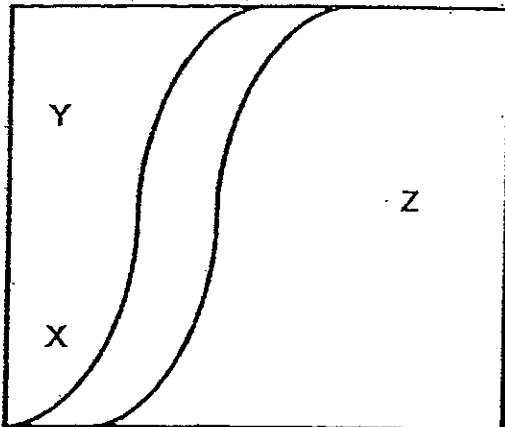

Diagram 1

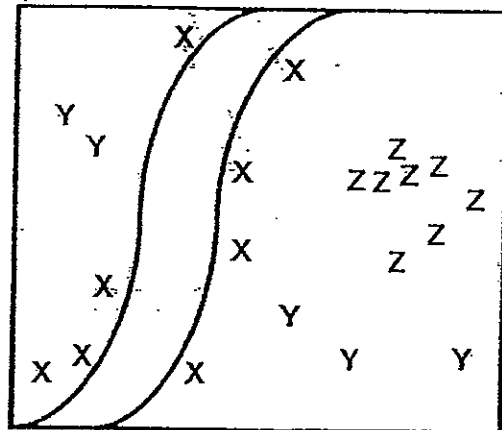

Diagram 2

Which of the following best describes how the seeds of plants X, Y and Z are dispersed?

	Plant X	Plant Y	Plant Z
(1)	wind	explosive action	water
(2)	water	wind	explosive action
(3)	water	animal	wind
(4)	explosive action	water	wind

15. In which part of the human respiratory system does the exchange of gases takes place?
- (1) Nose
 - (2) Mouth
 - (3) Air sacs
 - (4) Air tubes

16. Jason used the stroking method and made a nail into a temporary magnet.

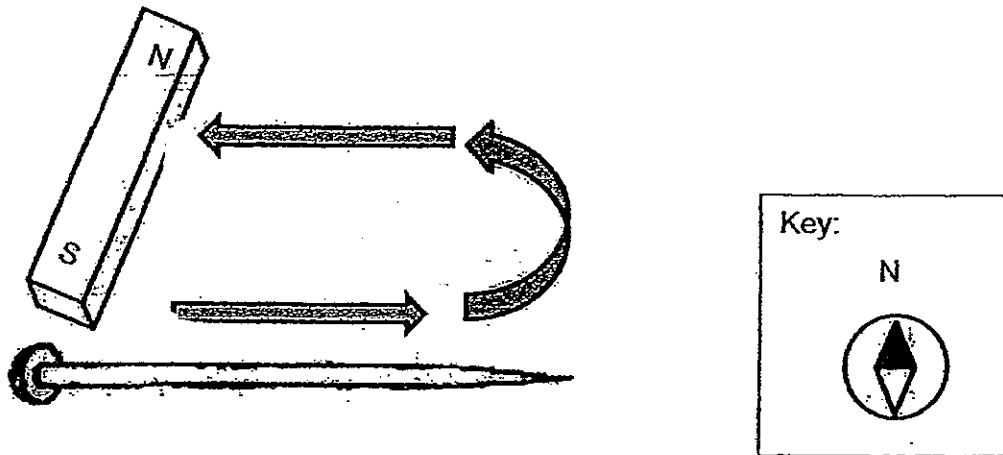

He then placed the nail near a compass. Which one of the following would he observe?

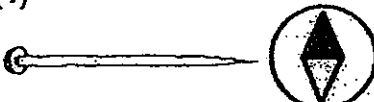
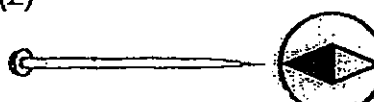
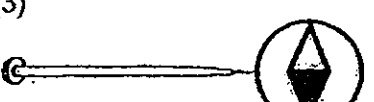
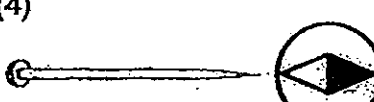
- (1) 
- (2) 
- (3) 
- (4) 

17. Corinne has four metal bars E, F, G and H and a bar magnet. She wanted to find out which of the metal bars are magnets. She brought the north pole of the bar magnet to the ends of each metal bar.

E

X		Y
---	--	---

F

X		Y
---	--	---

G

X		Y
---	--	---

H

X		Y
---	--	---

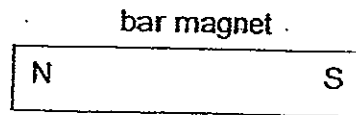

The table below shows what Corinne observed.

Metal bar	Observations	
	North pole and end X	North pole and end Y
E	No reaction	No reaction
F	Attracted	Repelled
G	Repelled	Attracted
H	Attracted	Attracted

Which one of the following statements about the metal bars is correct?

- (1) Bar E is a weak magnet.
- (2) Bar H is made of copper.
- (3) Two of the metal bars are magnets.
- (4) None of the metal bars is a magnet.

18. Susan wanted to compare the hardness of 4 types of materials, P, Q, R and S. She conducted a scratch test on the materials and recorded her observations in the table below.

Type of material used to scratch	Presence of scratch marks on materials			
	P	Q	R	S
P			✓	
Q	✓		✓	✓
R				
S	✓		✓	

Arrange the materials in descending order of hardness.

- (1) Q, P, S, R
 - (2) Q, S, P, R
 - (3) R, P, S, Q
 - (4) R, S, P, Q
19. Julia wanted to find out the factors affecting how salt dissolves in water. She used two identical beakers in her experiment and followed the steps below.

Step 1	Pour 150 ml of iced water into one beaker.
Step 2	Pour 150 ml of hot water into the other beaker.
Step 3	Add 6 teaspoons of salt into each beaker.
Step 4	Stir the mixture at a constant rate and measure the time taken for the salt to dissolve.

The aim of Julia's experiment was to find out if the _____ affects the time taken for the salt to dissolve.

- (1) type of liquid
- (2) temperature of water
- (3) amount of salt added
- (4) amount of water used

20. The table shows the melting and boiling points of 2 substances, V and W.

Substance	Melting point / °C	Boiling point / °C
V	-25	297
W	14	563

Which one of the following shows the correct state of substances V and W at 12°C and 498°C respectively?

Substance V		Substance W	
12°C	498°C	12°C	498°C
(1) solid	liquid	liquid	solid
(2) solid	gas	liquid	gas
(3) liquid	solid	solid	gas
(4) liquid	gas	solid	liquid

21. Jason has 2 objects, A and B. He hung them from the ceiling and placed a torch and the objects in a straight line in a dark room as shown below.

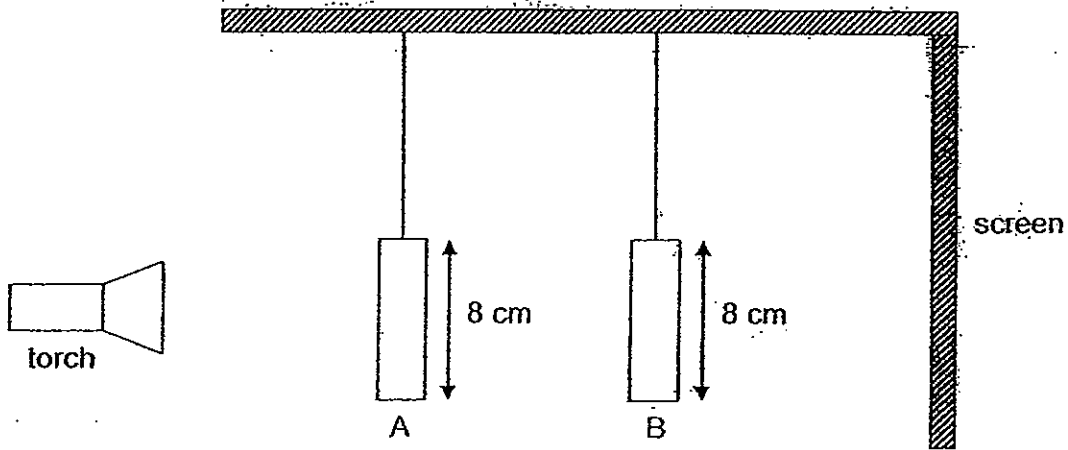

The diagram below shows their shadows on the screen when the torch is switched on.

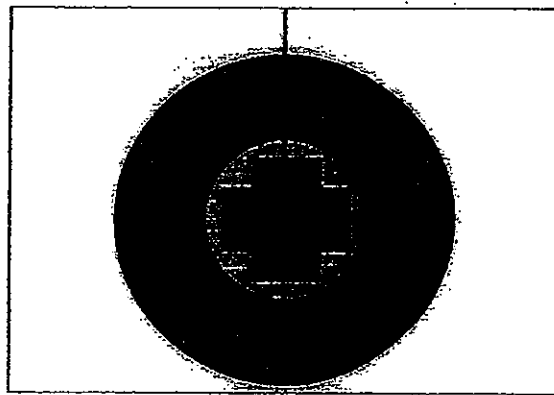

Which one of the following objects are A and B?

	A	B
(1)	opaque ring	opaque cross
(2)	opaque cross	opaque ring
(3)	transparent ring	opaque cross
(4)	transparent cross	opaque ring

22. Study the diagram below carefully.



The girl sitting by the window is able to read because light given out by the _____

- (1) book is reflected from the girl's eyes to the sun
- (2) sun is reflected from the girl's eyes to the book
- (3) girl's eyes is reflected from the sun to the book
- (4) sun is reflected from the book to the girl's eyes

23. Jenny conducted an experiment to find out how much light can pass through 4 different materials U, V, W and X using a datalogger with a light sensor.

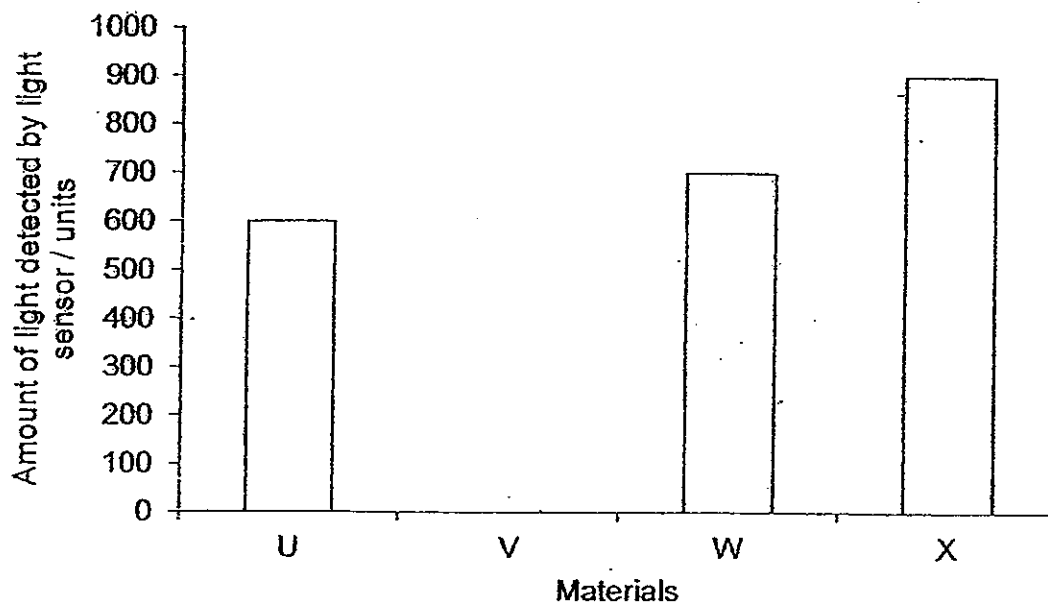

Based on the graph above, which one of the following statements is true?

- (1) Material V allows some light to pass through.
- (2) Material U allows more light to pass through than Material X.
- (3) When Material U and Material V are placed one behind the other, no light can pass through.
- (4) The total amount of light that can pass through Material U and Material W when they are placed one behind the other is 1300 units.

24. Different shaped containers on a conveyor belt pass under a running tap. The conveyor belt is moving at a constant speed. The water flows at a constant rate and none of the containers fills completely.

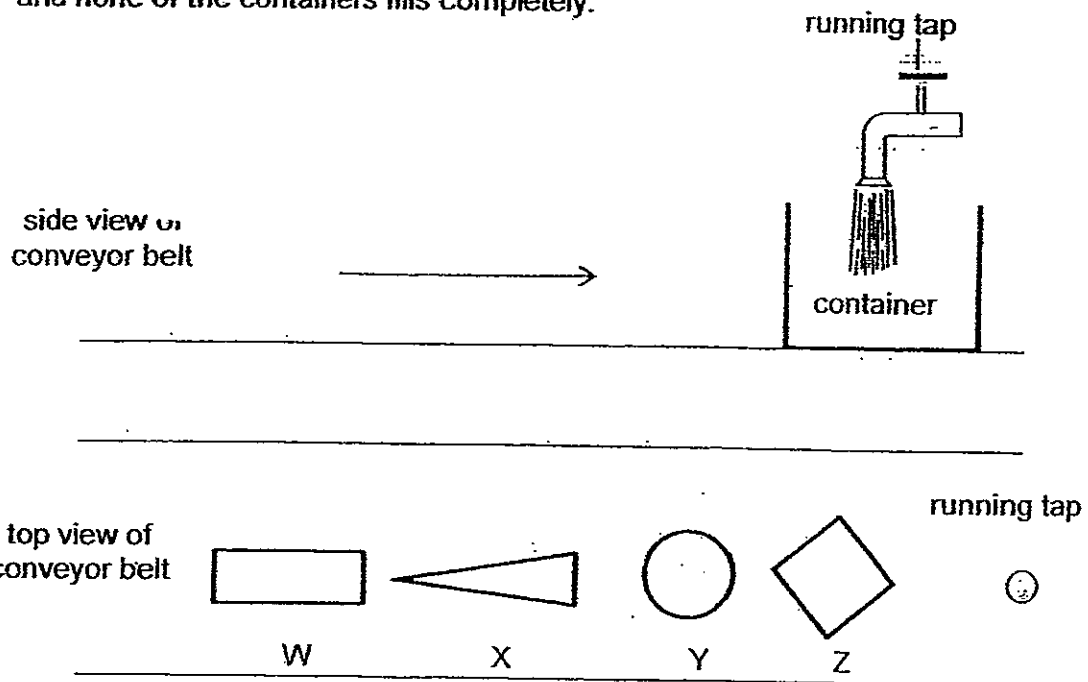

Which container has the greatest volume of water in it after they have all passed under the tap?

- (1) W
- (2) X
- (3) Y
- (4) Z

25. James had a rod made of 2 different materials, P and Q, as shown in the diagram.



He wrapped the centre of the rod with a piece of white paper as shown below.

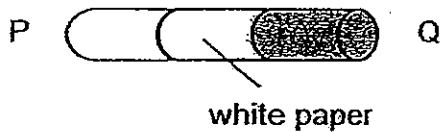

James passed the flame of a candle over the white paper several times.

After a while, James observed that only T (the end of the white paper nearer to Q) was scorched as shown in the diagram.

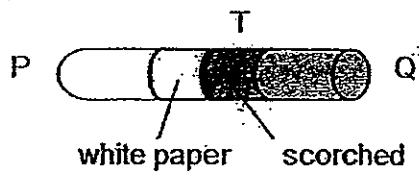

Which one of the following reasons best explains why T was scorched?

- (1) T retained more heat as heat travelled from P to Q.
- (2) P trapped more heat than Q so less heat was transferred to T.
- (3) Q was a better conductor of heat than P so more heat was absorbed by T.
- (4) Q was a poorer conductor of heat than P so heat was conducted slower away from T.

26. The following statements show the different phases in the water cycle. However, they are not arranged in the correct sequence.

- A Rain falls to the earth.
- B Water vapour rises and cools.
- C The clouds become heavier and heavier.
- D Water evaporates from the seas, rivers and lakes.
- E Water vapour condenses to form small droplets of water.

Which one of the following shows the correct sequence of the water cycle?

(1)

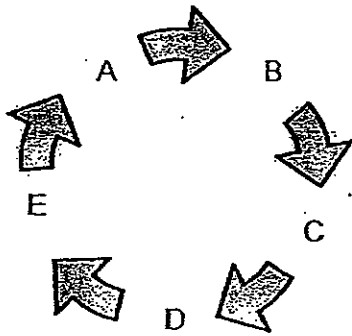

(2)

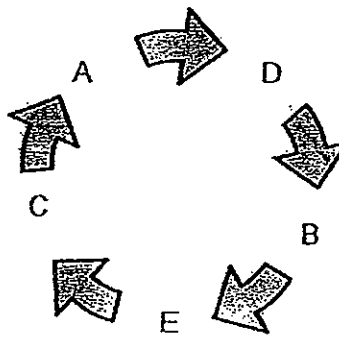

(3)

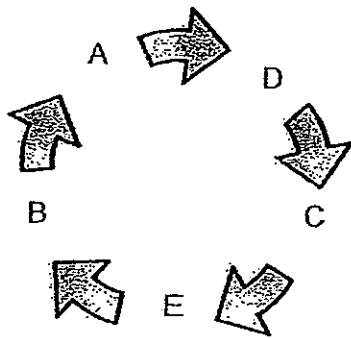

(4)

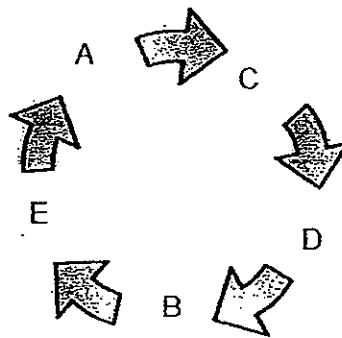

27. Jack observed the temperature of pure water in a beaker from the time it was taken out of the freezer with a temperature of -8°C till the time it reached the room temperature of 25°C . He recorded the observations in a graph. Which one of the following graphs is correctly plotted by Jack?

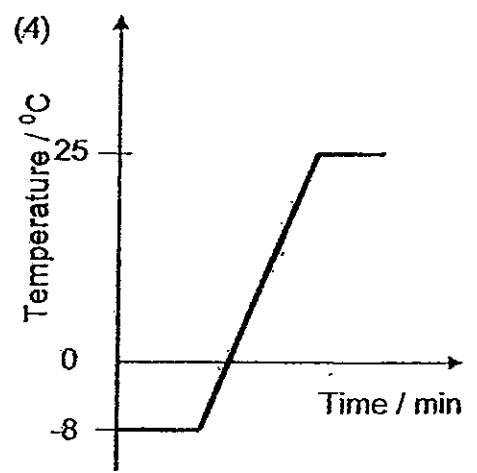
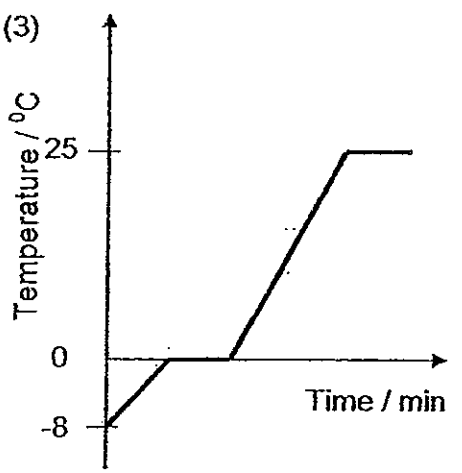
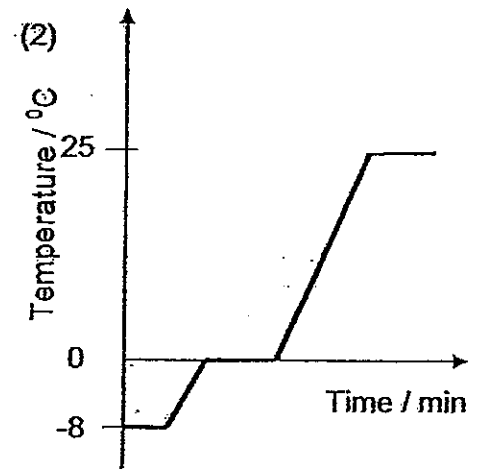
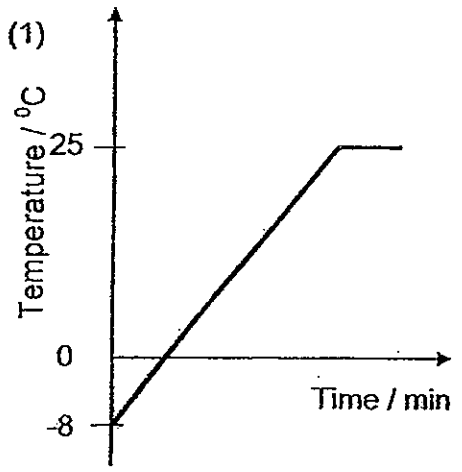

28. The diagram below shows a set-up in which water changes from one state to another.

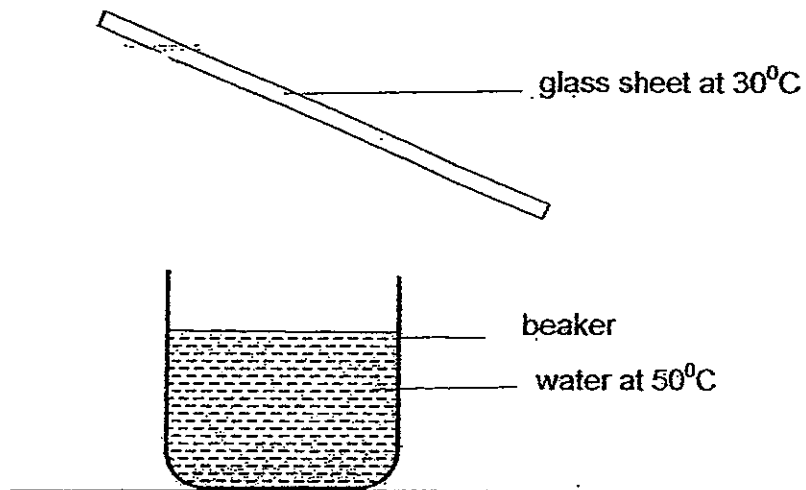

Which of the following will most likely result in an increase in the amount of water droplets formed on the glass sheet?

- A Add ice into the water
 - B Use a colder sheet of glass
 - C Increase the temperature of the water
 - D Use a beaker with a greater exposed surface area
-
- (1) A and D only
 - (2) B and C only
 - (3) B, C and D only
 - (4) A, B and D only

29. Four pupils set up two circuits. They placed material P in the same position in the circuits shown below. They recorded their observations in the table below.

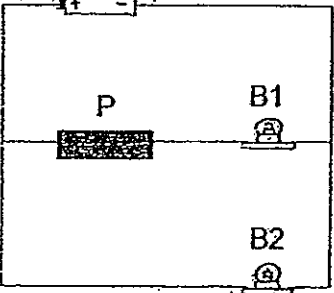
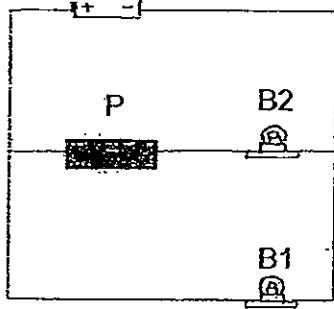
Set-up	Observations
 <p style="text-align: center;">Circuit 1</p>	<p>1. B1 lit up 2. B2 did not light up</p>
 <p style="text-align: center;">Circuit 2</p>	<p>1. B1 lit up 2. B2 did not light up</p>

Based on their observations above, each pupil gave a reason why B2 did not light up.

- Jessie: The filament in B2 is fused.
 Mark: P was not a conductor of electricity.
 Sharon: P was not connected to the circuit properly.
 Julien: B1 was not properly connected to the circuit.

Which of the children made the correct observation/s?

- (1) Jessie only
 (2) Jessie and Julien only
 (3) Mark and Sharon only
 (4) Mark, Sharon and Julien only

30. Four copper wires, U, V, W and X, run through a sealed container as shown below. One of the copper wires was broken and Alvin used a circuit tester to find out which wire was broken.

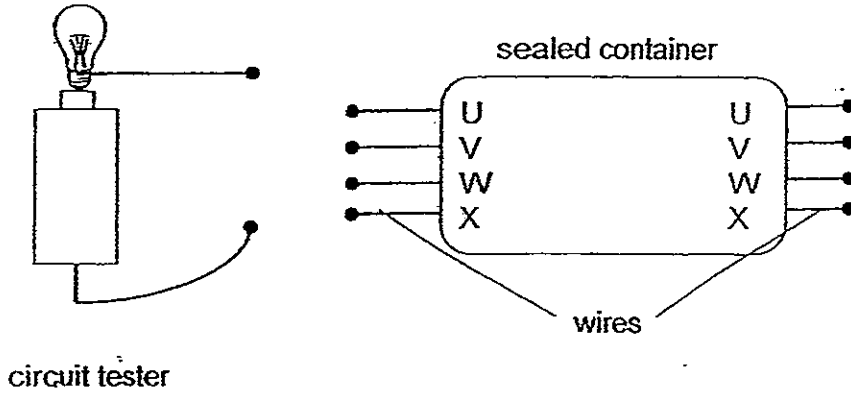

He connected wires U, V, W and X with a copper wire as shown.

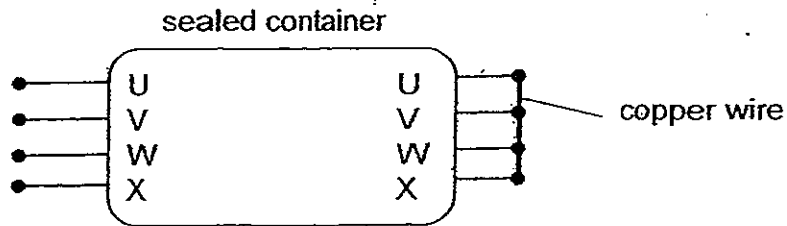

He recorded his observations in the table below.

Wires circuit tester was connected to	Result
U and V	bulb did not light up
V and W	bulb lit up
U and X	bulb did not light up
V and X	bulb lit up

Based on his results, which copper wire in the sealed container was broken?

- (1) U
- (2) V
- (3) W
- (4) X

- End of Section A -



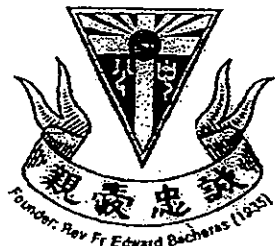

CATHOLIC HIGH SCHOOL
PRIMARY 5
SEMESTRAL EXAMINATION 2
2012

SCIENCE

Name: _____ ()

Class : Primary 5

Date : 25 October 2012

BOOKLET B

14 Questions
40 Marks

Total Time for Booklets A & B: 1 hour 45 minutes

Instructions to Candidates

Follow all instructions carefully.
Answer all questions.

Parent's Signature: _____

Date: _____

Score	
Section A	60
Section B	40
Total	100

Section B : Open-Ended Questions (.40 marks.)

Read the following questions carefully and write your answers in the space provided. The maximum marks that can be awarded is shown at the end of each question or part-question.

31. Benjamin was asked to classify the following animals into two groups based on their characteristics.

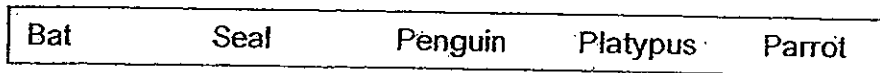

He realised that he could classify the animals in 2 different ways.

Chart 1

- (a) Write the headings for the classification chart below in the boxes provided. [1]

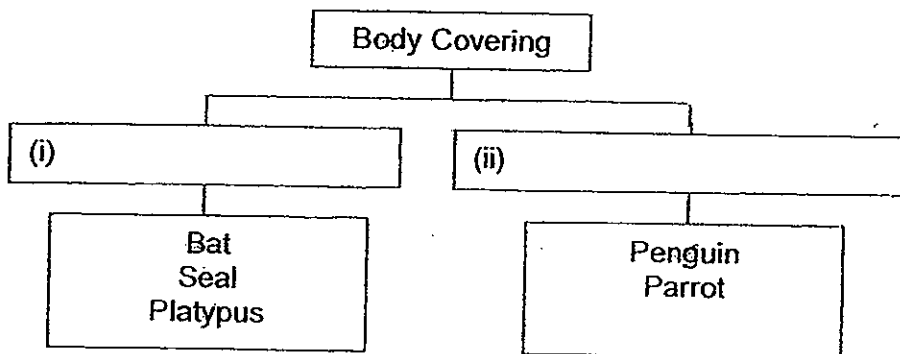
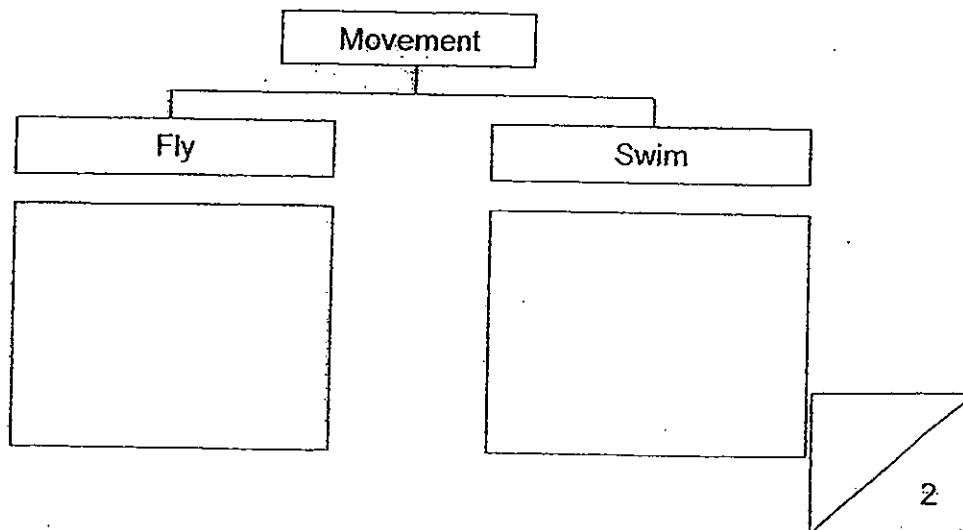

Chart 2

- (b) Benjamin then classified the animals according to the way they moved. Place the above animals in the correct boxes below. [1]



32. Some scientists wanted to study the digestive system of Animal Y. They fed Animal Y with the same amount of Foods P, Q and R over 3 days. The table below shows the type of food it was fed over the 3 days.

	Fed with
Day 1	Food P
Day 2	Food Q
Day 3	Food R

Animal's Y digestive system was checked at specific times each day to find out how much food had been digested.

The results were plotted in the graph below.

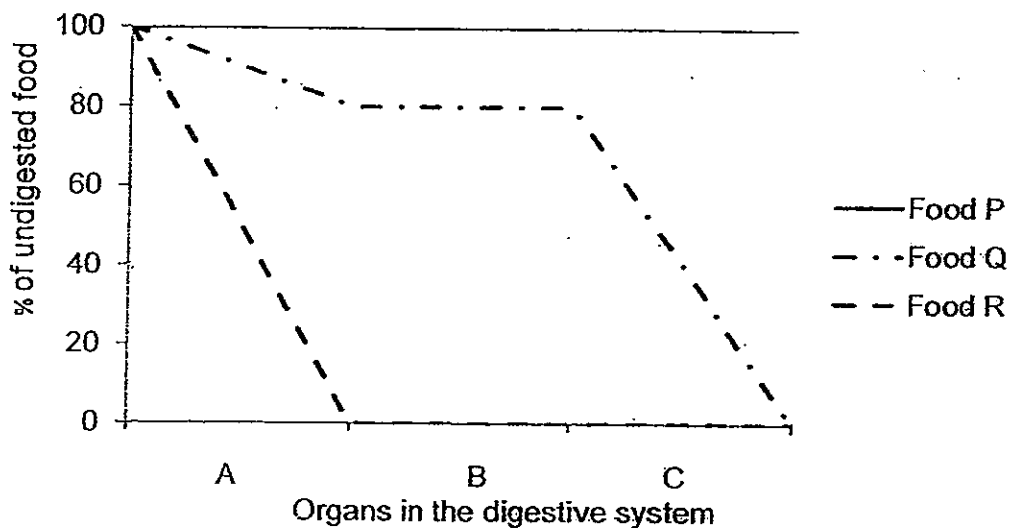

- (a) Which of the Foods P, Q and R was not digested at all? [1]

- (b) Based on the results above, explain your answer in (a). [1]

- (c) State another variable that must be kept the same to ensure a fair test. [1]

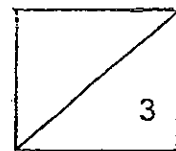

33. Ravi wanted to find out whether the activities he was engaged in would affect his pulse rate. He recorded his pulse rate using a pulse rate monitor banded across his chest. During this period of his recording, he played tennis, rested, walked back to his flat, read a book and napped.

Ravi plotted a graph as shown below that showed changes to his pulse rate.

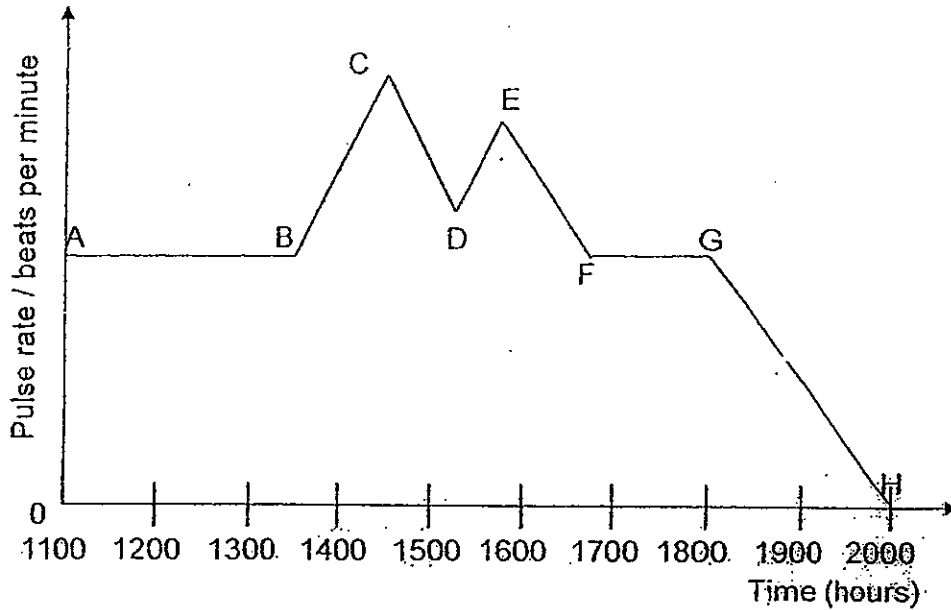

- (a) Which part(s) of the graph represent(s) Ravi's pulse rate when he was playing tennis? Explain your answer. [2]

- (b) Ravi's sister commented that he had plotted his graph wrongly from 1800hrs to 2000hrs. Do you agree? Explain your answer. [1]

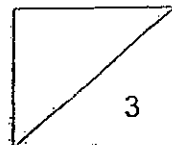

34. The diagram below shows a cross-section of the stem of the potted plant.

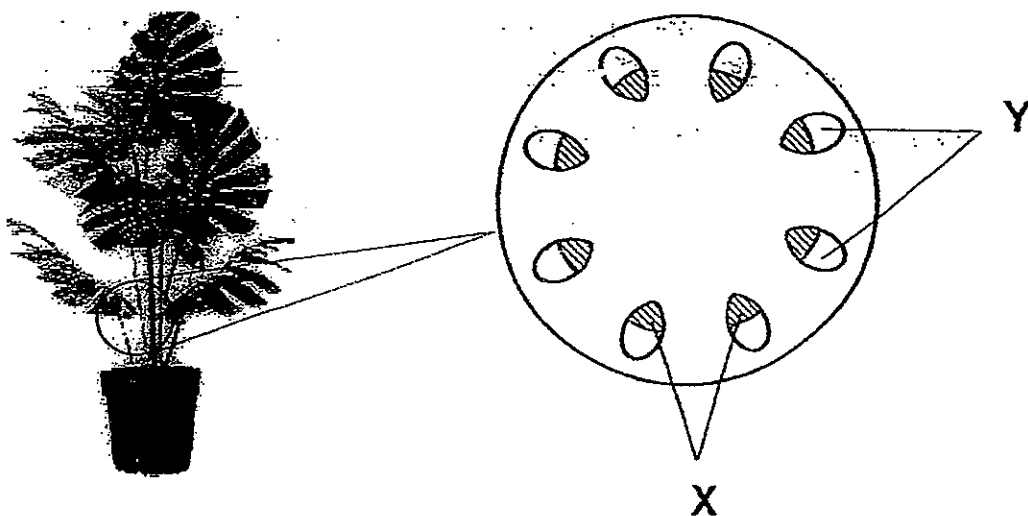

(a) Identify the parts labelled X and Y. [1]

(i) X: _____ (ii) Y: _____

Amindah saw her neighbour's rose plant flowering. She wanted to have a pot of rose plant as well and requested for a stalk from her neighbour, Mrs Lim. She plucked out a stalk and brought it home. Despite giving water and receiving sunlight as shown in the picture below, the stalk of rose died.



Mrs Lim's pot of rose plant

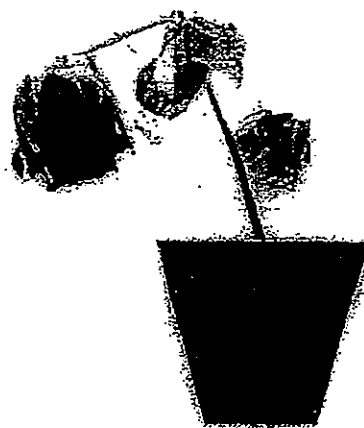

The stalk of rose that Amindah plucked

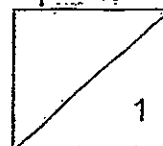

(b) Explain why the stalk of rose that Amindah plucked was not able to survive. [2]

(c) It is observed that the florist would always cut diagonally at the ends of the flower stems as shown below.

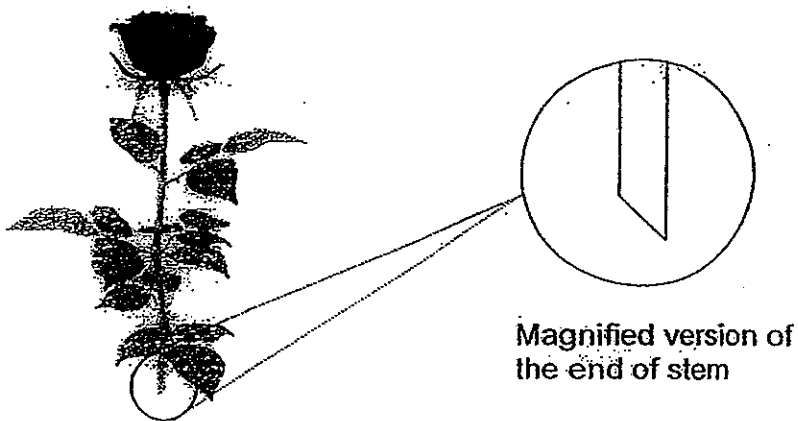

Suggest a reason why this is a common practice to cut the ends of flower stems. [1]

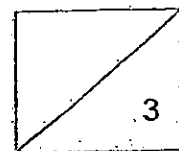

35. A terrarium is a sealed container that contains plants planted mainly in soil.

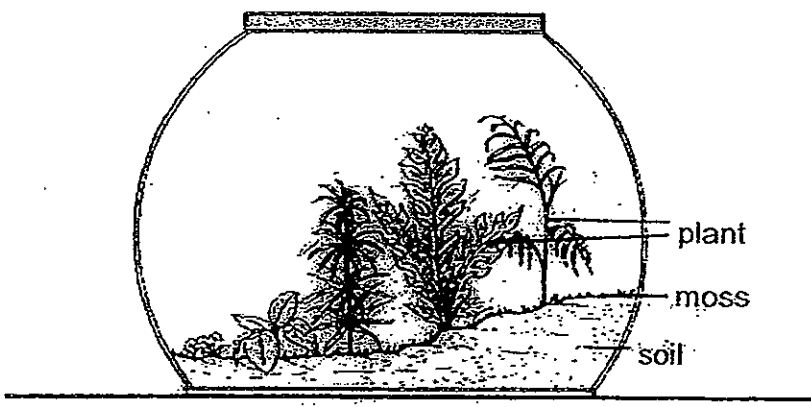

David was going away on a vacation and wanted to ensure that his potted plants would survive even without being watered for three weeks. Based on the idea behind a terrarium, he watered his plants and placed them in a structure as shown below.

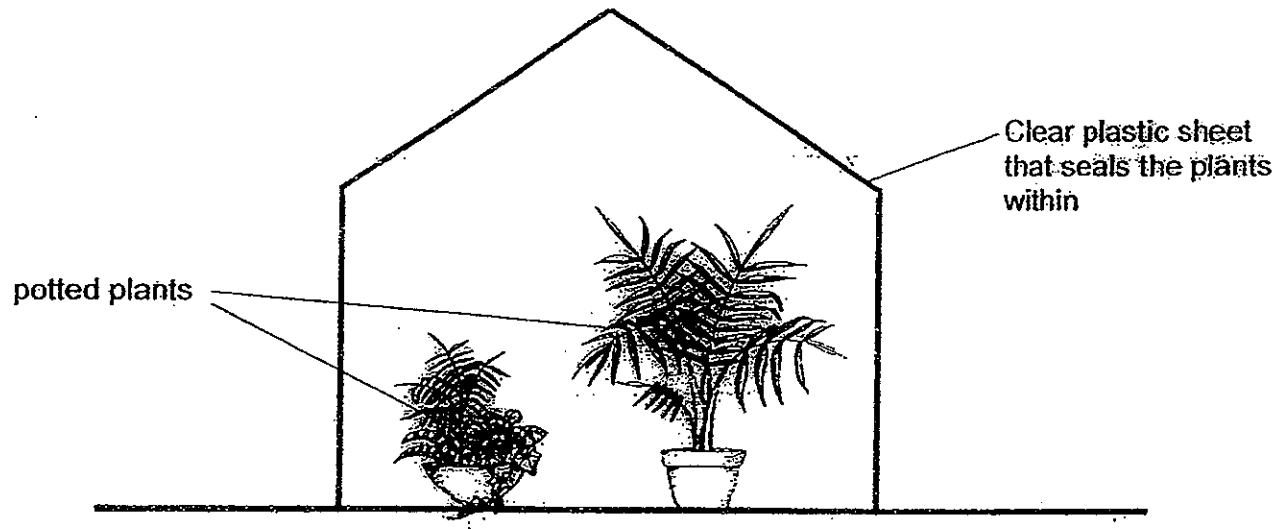

Explain what will happen to David's plants after three weeks. [2]

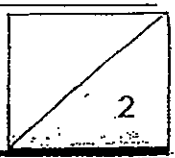

36. The diagram below shows how food and air are transported in the human body.

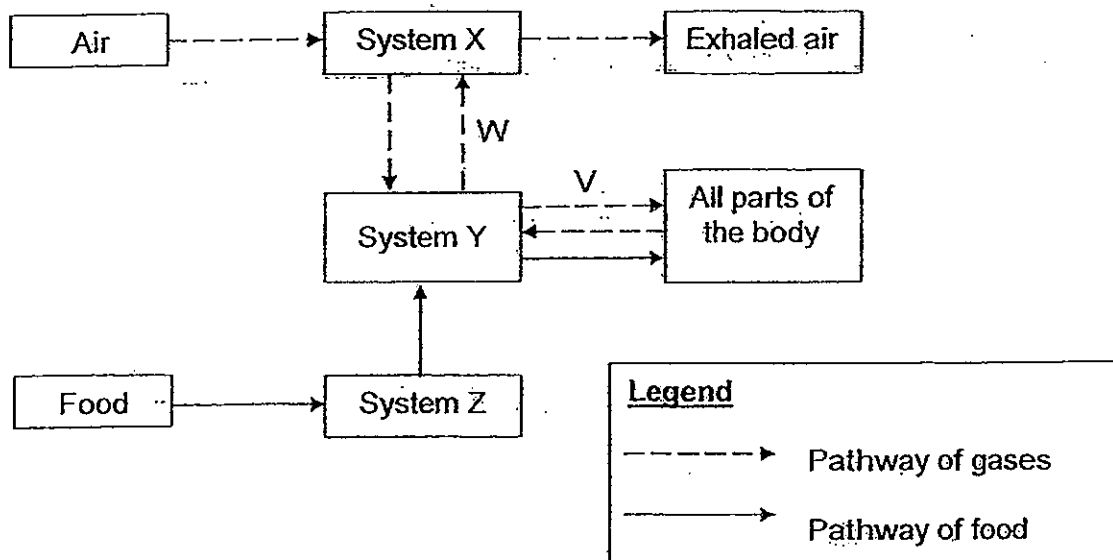

(a) Identify the following systems: [1]

System X: _____

System Y: _____

(b) One of the gases found at W is needed for an important process in plants. Name the process and state how this gas is important to plants. [1]

(c) Describe one difference between the air at W and V. [1]

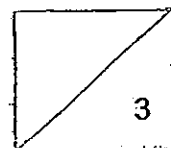

37. Lisa realised that she was able to roll her tongue just like her mother does. However, her father was unable to do so.

(a) Which part of the cell controls her ability to roll her tongue? [1]

(b) Study the following family tree and answer the questions which follow.

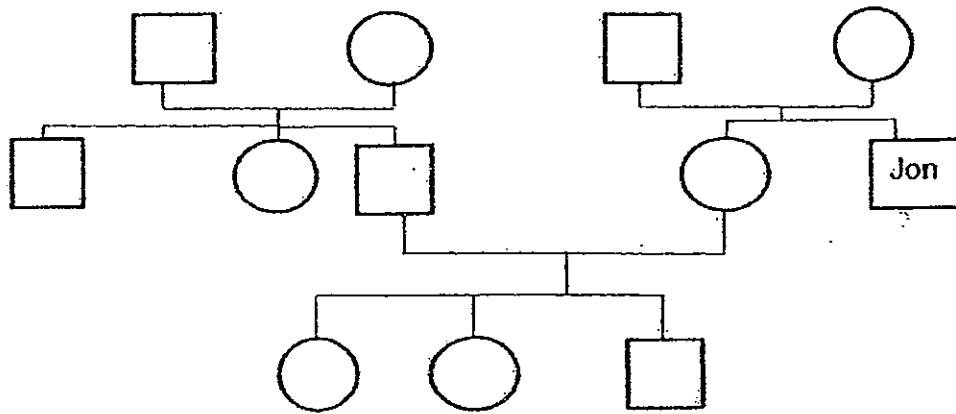

(i) How many siblings does Jon have? [1]

(ii) How many nieces does Jon have? [1]

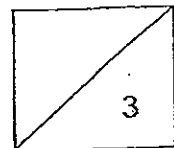

38. Elaine had two identical containers, E and F, of equal capacity of 1500 cm^3 each. She placed them on a balance as shown in the diagram below.

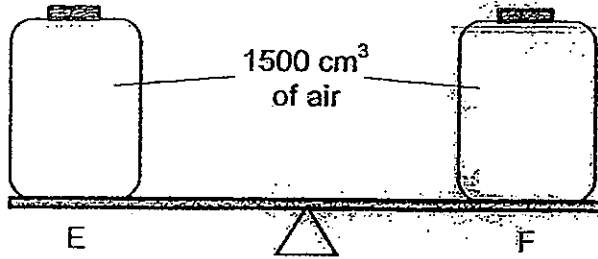

- (a) Describe what Elaine would observe when she pumps in another 1000 cm^3 of air into container E. [1]

- (b) What would be the volume of air in container E after Elaine had pumped in the 1000 cm^3 of air? Explain your answer. [1]

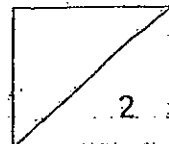

39. Mark was standing by the side of the road waiting for his friend to pick him up. He suddenly noticed that he had multiple shadows as shown below.

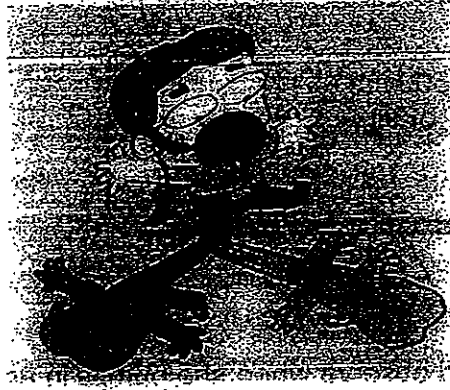

- (a) Explain why Mark had two shadows. [1]

- (b) How are shadows formed? [1]

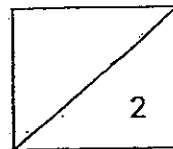

40. Mary installed a heating element inside a glass container. She filled the container with some coloured gas and switched on the heater.

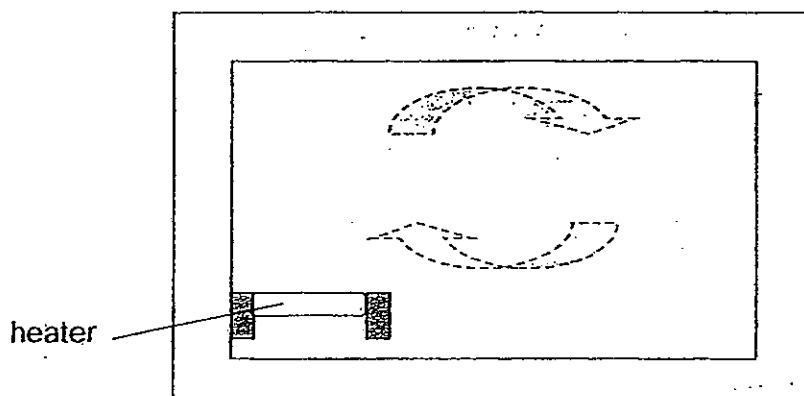

After some time, she saw the coloured gas moving in the directions as shown in the diagram above.

- (a) What conclusion can Mary make about air based on her observation? [1]

- (b) From the above conclusion, explain why an air-conditioner is usually placed near the ceiling and not the floor. [2]

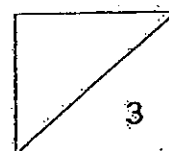

41. Mary took out some ice cubes from the freezer and laid them on the table. She observed X above the ice cubes as shown below:

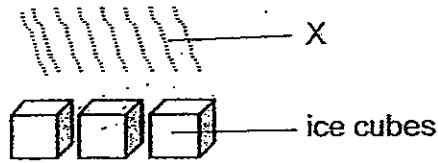

- (a) What is X? [1]

- (b) Explain how X is formed. [1]

The misting fan, as seen below, is equipped with special spray nozzles that release mist in front of an air flow:



The mist is propelled by the air flow from the fan and travels through the air, causing the surroundings to feel cooler.

- (c) Explain how the mist causes the surrounding air to be cooler. [2]

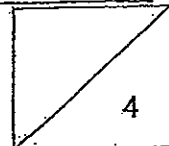

42. Ken was on a winter holiday. The family got into the car in the morning and his father turned on the heater. After a while, Ken noticed that the windscreens and windows of the car had become misty.

Temperature inside the car was 25°C

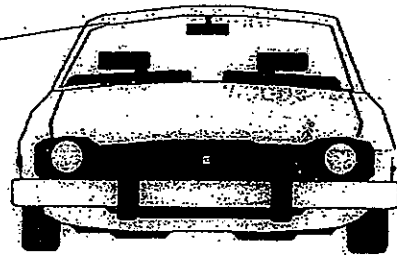

Outside temperature was 2°C

- (a) On which surface of the windscreens and windows would Ken find the mist? Explain your answer. [2]

- (b) Besides wiping away the mist, suggest a way that Ken's father can clear the windows and windscreens. [1]

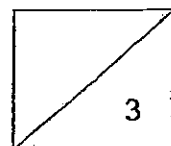

43. In the diagrams below; the ceiling lamps can be connected in two different ways in an apartment.

(a) Mark a cross (X) on the electrical circuit in diagram 1 to show the position of a switch that only stops the bathroom lamp from working when it is switched off.

[1]

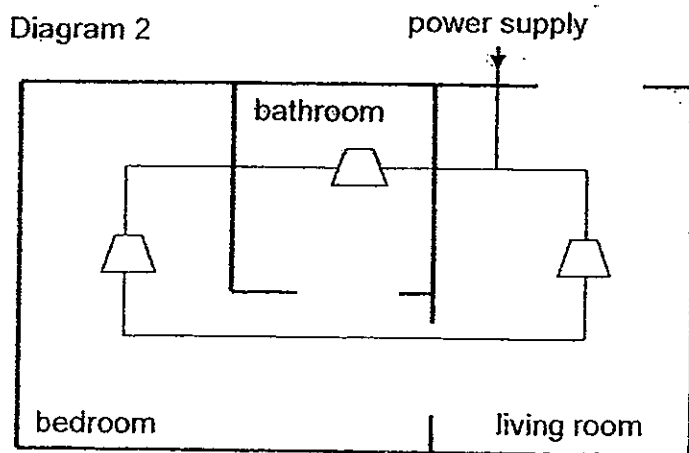
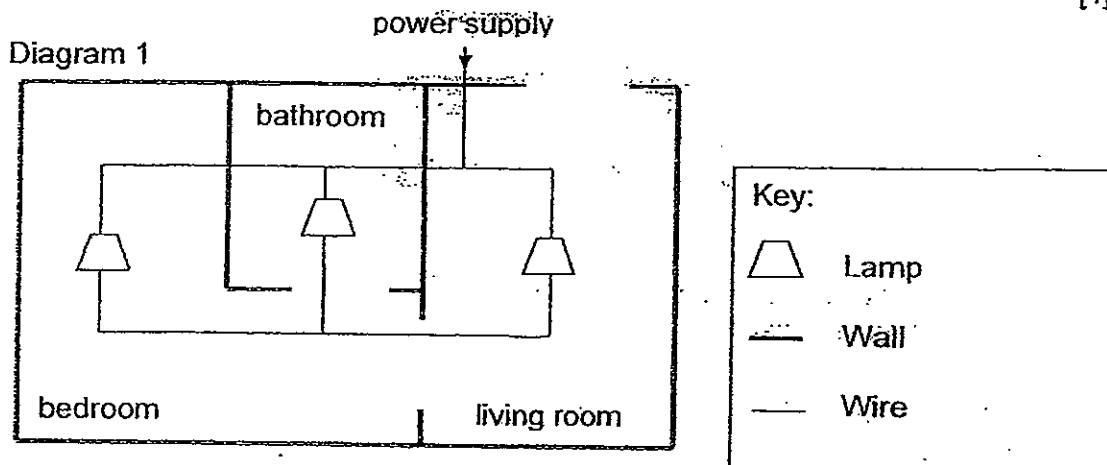

(b) Compare diagrams 1 and 2 and explain which is a better way to connect the lamps in an apartment.

[2]

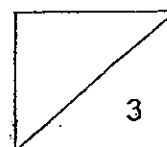

44. The diagram below shows a circuit. The table shows what happens to the light bulb when four rods, A, B, C and D, were connected, one at a time, to the contact points X and Y.

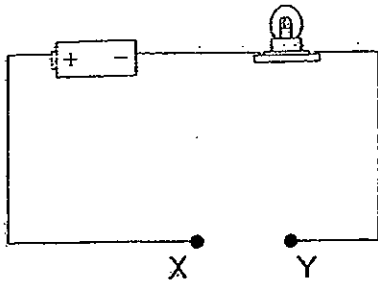

Rod	Did the bulb light up?
A	No
B	Yes
C	No
D	Yes

(a) Based on the results above, what can you conclude about the rods? [1]

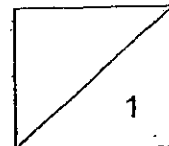

In another experiment, the same four rods, A, B, C and D, were placed at different positions, S1, S2, S3 and S4, in the following circuit.

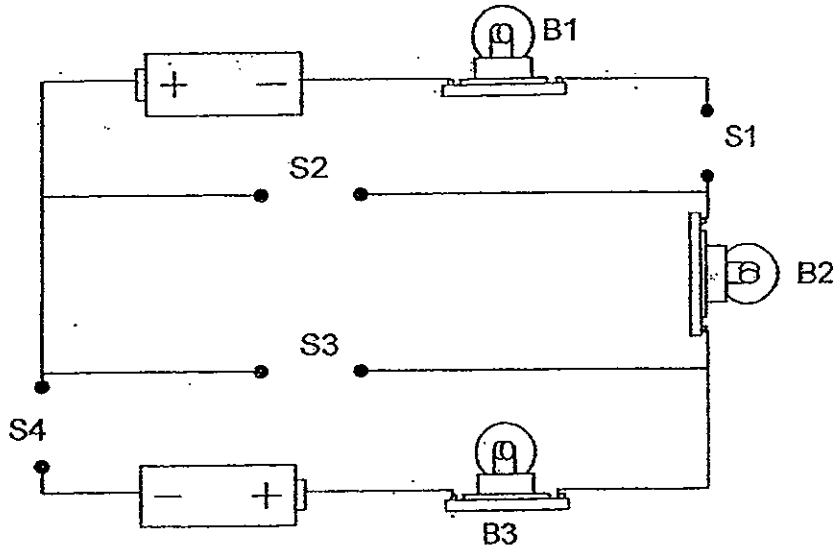

- b) Complete the following table.
Put a tick (✓) in the appropriate box to show whether the bulb would light up. [1]

Position of rods				Bulbs		
S1	S2	S3	S4	B1	B2	B3
D	B	A	C			

- c) The rods were rearranged and all 3 bulbs lit up.
Write letters A, B, C and D in the appropriate box below. Each letter can only be used once. [1]

Position of rods				Bulbs		
S1	S2	S3	S4	B1	B2	B3
				✓	✓	✓

- End of Section B -

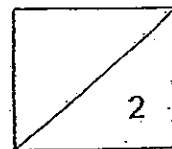



ANSWER SHEET

EXAM PAPER 2012

**SCHOOL : CATHOLIC HIGH
SUBJECT : PRIMARY 5 SCIENCE**

TERM : SA2

Q1	Q2	Q3	Q4	Q5	Q6	Q7	Q8	Q9	Q10	Q11	Q12	Q13	Q14	Q15	Q16	Q17
2	4	4	3	2	2	3	1	4	3	2	4	1	2	3	4	3

Q18	Q19	Q20	Q21	Q22	Q23	Q24	Q25	Q26	Q27	Q28	Q29	Q30
2	2	4	1	4	3	1	4	2	3	3	1	1

- 31)a)i)hair ii)feather
 b)Bat Seal
 Parrot platypus
 Penguin

32)a)Food P.

- b)The percentage of the undigested food is 100%.
c)When Animal Y was fed.

33)a)BC. Ravi's heart pump faster to transport more oxygen to burn more food so as to produce more energy.

- b)Yes I agree. If his pulse rate went down to zero, that means he is dead.

34)a)i)xylem ii)phloem

b)The water carrying tubes have been broken so water taken in by the stem cannot be transported to the flower and leaves.

c)When the stem is cut diagonally, it has a larger increased exposed surface area.

35)The plants will die as even though there is evaporation, as the water droplets slide to the side of the plastic sheet but not back into the pot without water plants will die.

- 36)a)X: respiratory system Y: circulatory system
 b)Carbon dioxide is needed for plants to make food.
 c)W is richer in carbon dioxide than V.

- 37)a)The nucleus.
 b)i)one. ii)Two.

- 38)a)The balance would go down at container E and go up at container F.
 b)1500cm³. Air has no definite volume and it takes the volume of its container.

- 39)a)There are a two lamppost at both sides of him.
 b)When an object block light.

- 40)a)Warm air rises and cold air sinks.
 b)It the air-conditioner is placed near the ceiling, it can cool the warm air which rises from the floor. The cool air them sinks to keep the entire room cold faster as compared to if it is placed on the floor.

- 41)a)Mist.
 b)The water vapour in the surrounding air loses heat and condenses to from water droplets.
 c)The water droplets gain heat from the surrounding air and evaporate to from water vapour.

- 42)a)Mist would be found on the inner surface of the wind screen sand window as the warm water vapour inside the car condenses on the cooler surface of the glass and form tiny droplets.
 b)He could turn off the heater.

43)a)

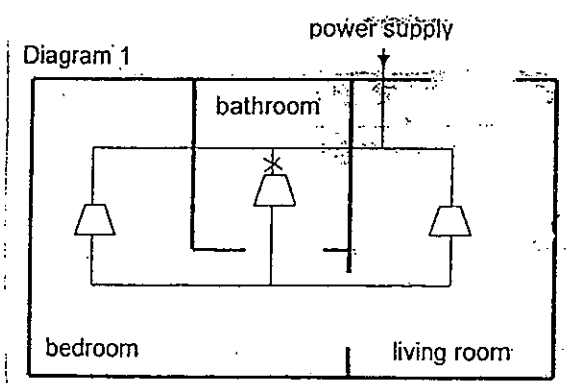

- b)Diagram 1 is a better way as the lamps are arranged in parallel so when one fuses, the others will still remain lighted.

44)a)Rods B and D are conductors of electricity but rods A and C are insulators of electricity.

b)B1

c)D A C B

