



**RAFFLES GIRLS' PRIMARY SCHOOL**  
**SEMESTRAL ASSESSMENT (1)**  
**2012**

Section A	60	
Section B	40	
Your score out of 100 marks		
Highest score	Class	Level
Average score		
Parent's signature		

Name : \_\_\_\_\_ Index No: \_\_\_\_\_ Class: P 5 \_\_\_\_\_

2 May 2012                      SCIENCE                      Attn: 1 h 45 min

**SECTION A (30 X 2 marks)**

For each question from 1 to 30, four options are given. One of them is the correct answer. Make your choice (1, 2, 3 or 4). Shade the correct oval on the Optical Answer Sheet.

1. Study the flow chart below.

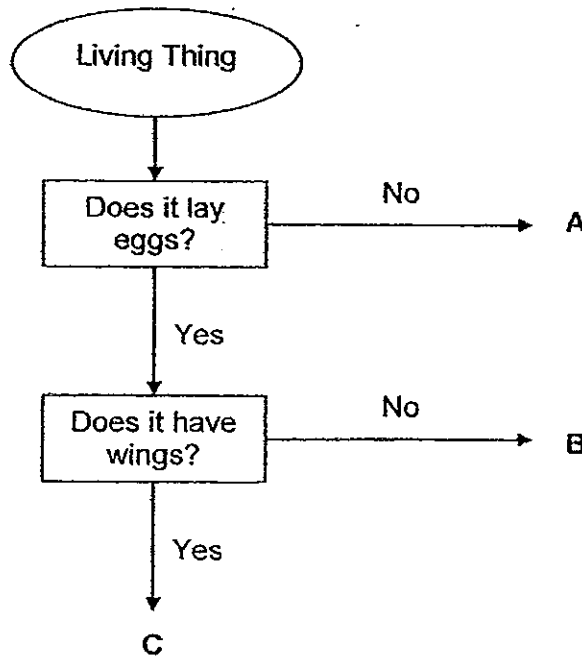

Which one of the following best represents A, B and C?

	A	B	C
(1)	Frog	Dolphin	Penguin
(2)	Platypus	Frog	Bat
(3)	Dolphin	Platypus	Housefly
(4)	Whale	Bat	Penguin

2. Four pupils, Alan, Bob, Carl and David, each stated a characteristic of an insect.

- Carl : All insects have a head, thorax and abdomen.
- Bob : All insects reproduce by laying eggs.
- Alan : All insects have wings.
- David : All insects have 6 legs

Which of the following pupil(s) has/have stated the characteristic(s) of an insect which make(s) it different from the other groups of animals?

- (1) Alan only
- (2) Carl and David only.
- (3) Bob, Carl and David only.
- (4) Alan, Bob, Carl and David.

3. The following chart provides incomplete information about living things, P and Q. The characteristic, R, is missing from the chart.

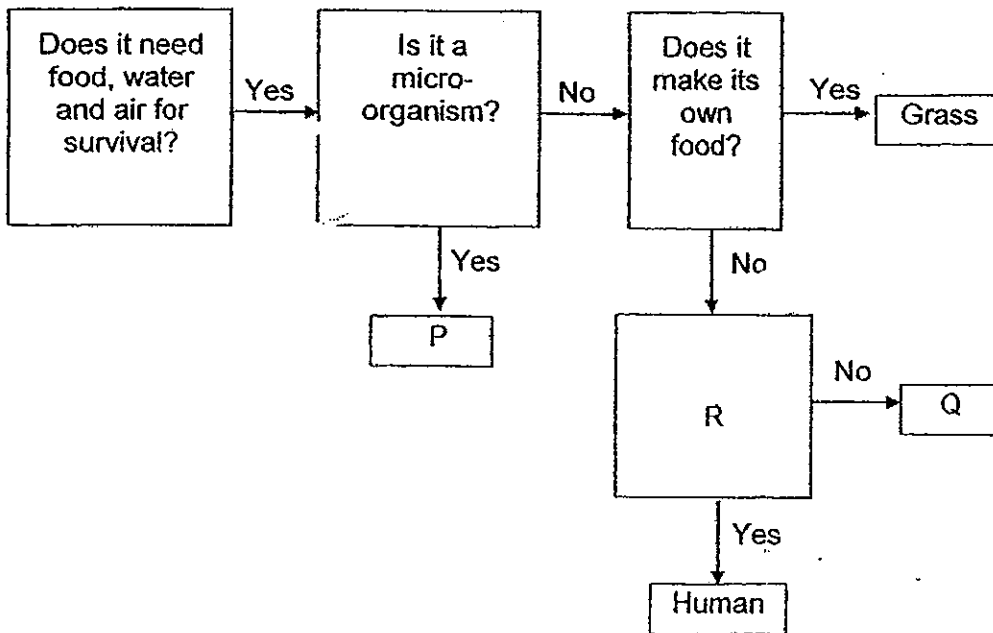

Which of the follow correctly represents P, Q and R?

	P	R	Q
(1)	Tree fern	Does it feed on dead matter?	Mushroom
(2)	Bacteria	Does it move from one place to another?	Mushroom
(3)	Yeast	Does it reproduce by spores?	Tree Fern
(4)	Yeast	Does it respond to changes in the surrounding?	Snail

- 4 Jenny conducted an experiment to investigate the condition affecting the rate of reproduction of bacteria. She prepared 2 identical set-ups of agar plates using petri dishes. Each set up contained similar quantity of bacteria X.

Set-up A was placed in a dark incubator at a temperature of 35°C. Set-up B was placed in the refrigerator at a temperature 5°C without any light source.

**DAY 1**

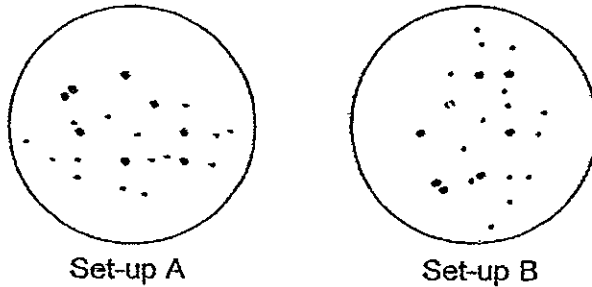

Jenny observed the 2 set-ups 2 days later and recorded the results as shown in the diagrams below.

**Day 3**

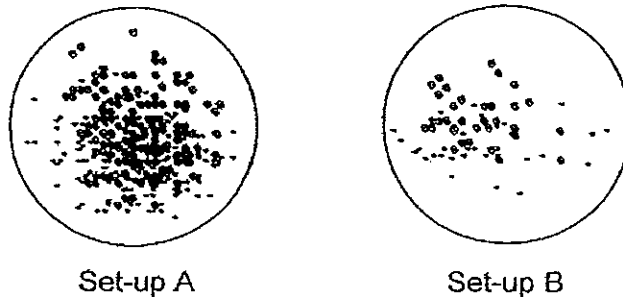

Which of the following is most likely to be the conclusion which she can draw on the reproduction rate of bacteria?

- (1) Bacteria reproduce at a faster rate without light.
- (2) Bacteria reproduce at a faster rate in a warmer environment.
- (3) Bacteria reproduce at a faster rate in a cooler environment.
- (4) Bacteria reproduce at a faster rate when there is more food.

5. Study the concept map below.

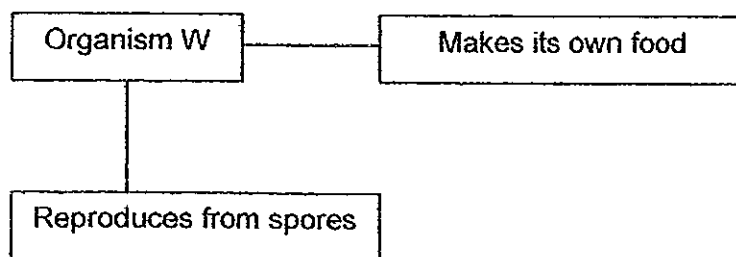

Which of the following can be Organism W?

- A Begonia
- B Bird's nest fern
- C Moss
- D Pineapple

- (1) B only
- (2) B and C only
- (3) A and D only
- (4) A, B and D only

6. In the life cycle of a butterfly, the young eats and grows rapidly at the \_\_\_\_\_ stage.

- |           |            |
|-----------|------------|
| (1) egg   | (2) larval |
| (3) pupal | (4) adult  |

7. Irene has been observing an animal, X, for the past few months in a clear glass tank.

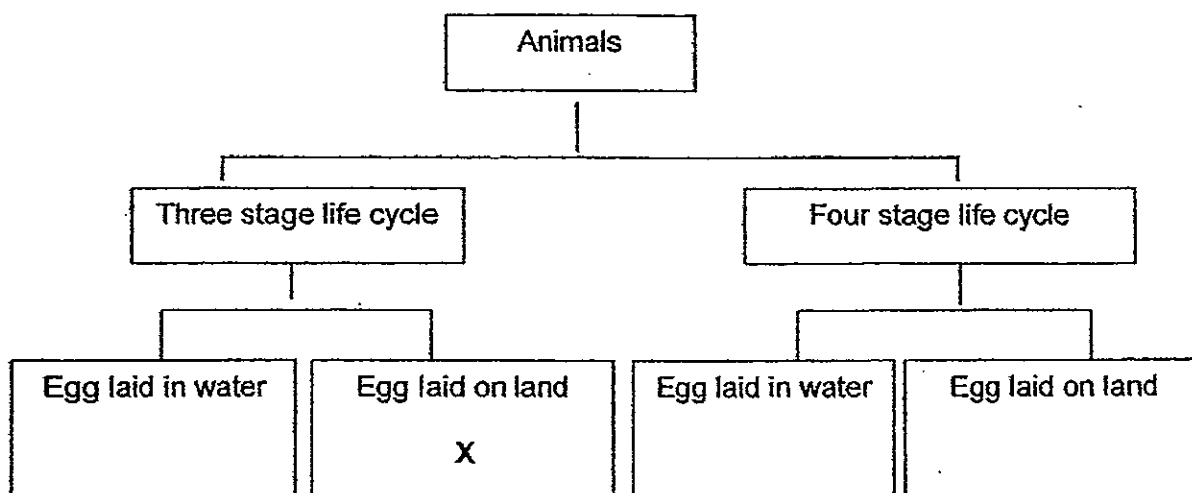

Which of the following animals is/are likely to represent Animal X?

- A Frog
- B Chicken
- C Cockroach
- D Grasshopper

- (1) A only
- (3) A, B and D only

- (2) C and D only
- (4) B, C and D only

8. John wanted to investigate if air is required for seed to germinate.

(A)

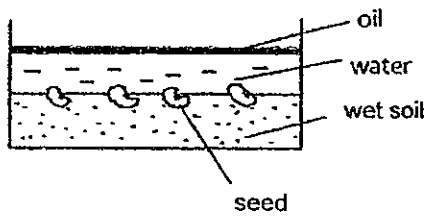

(B)

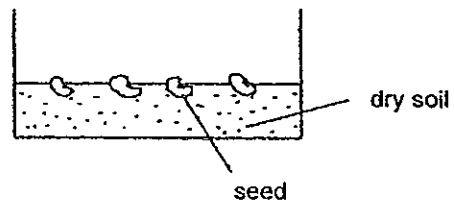

(C)

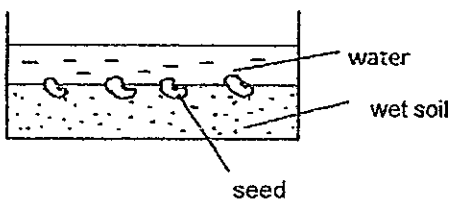

(D)

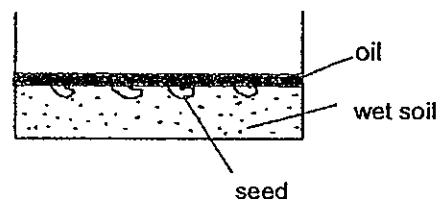

Which two set-ups should he compare in order to draw a correct conclusion?

- (1) A and B only
- (2) A and C only
- (3) B and C only
- (4) B and D only

Based on the information above, answer questions 9 and 10.

The diagram below shows Ryan's family tree for the inherited characteristic of detached earlobes.

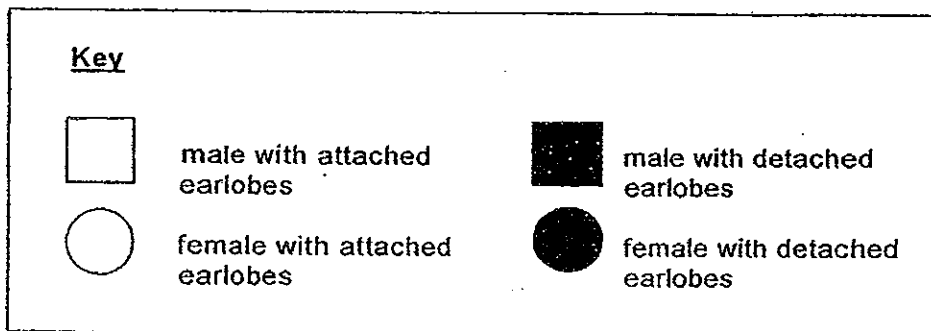
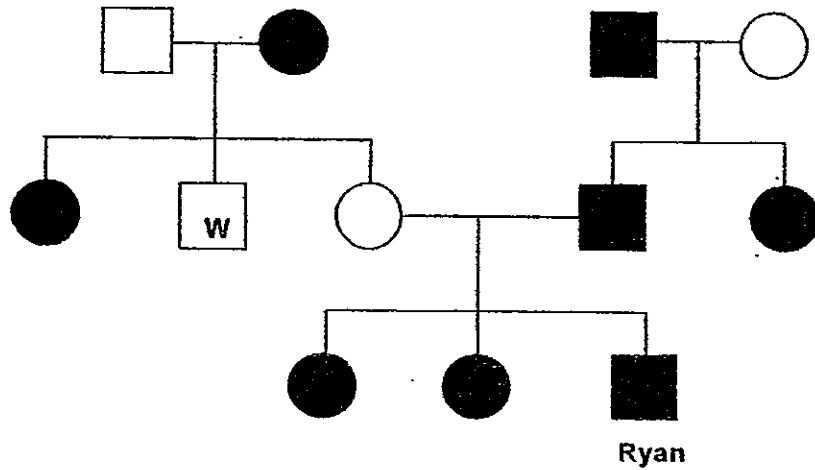

9. How many members of Ryan's mother's side of the family have attached earlobes?

- (1) 2
- (2) 3
- (3) 4
- (4) 8

10. Which of the following statements are true?

- A Ryan's uncle has detached earlobes.
- B All of Ryan's siblings have detached earlobes.
- C Two of Ryan's grandparents have detached earlobes.
- D Only males can inherit the characteristics of detached earlobes.

(1) A and B only

(2) A and C only

(3) B and C only

(4) A, B and C only

11. The diagrams below shows the reproductive systems, X, Y and Z of some organisms.

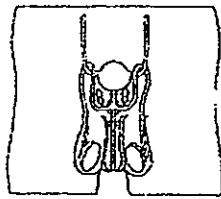

X

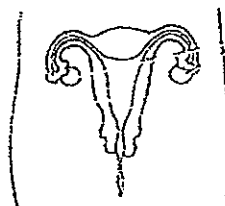

Y

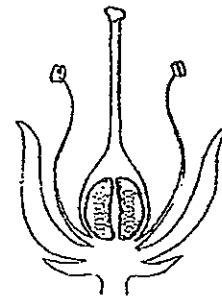

Z

Which statements about the reproductive systems X, Y and Z are correct?

- A Fertilisation can take place within X.
- B Y and Z contain the female reproductive cells.
- C Z contains both male and female reproductive cells.

(1) B only

(2) A and B only

(3) B and C only

(4) A, B and C



12. The diagram below shows a certain stage in the human reproduction process.

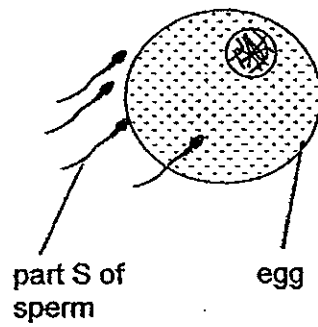

Which one of the following statement correctly describes the function of part S?

- (1) Part S contains the genes of the male sex cell.
  - (2) Part S helps in the pollination of the male sex cells.
  - (3) Part S helps the male sex cell to swim to reach the egg.
  - (4) Part S helps the sperm to take in oxygen during fertilisation.
13. While walking in a park, Vanessa observed a specimen as shown in the diagram below.

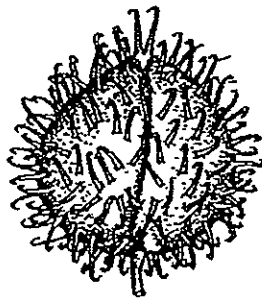

How is the above fruit of the plant most likely dispersed by?

- (1) water
- (2) mud
- (3) animal
- (4) splitting

14. The diagrams below show the longitudinal section of two types of flowers, X and Y.

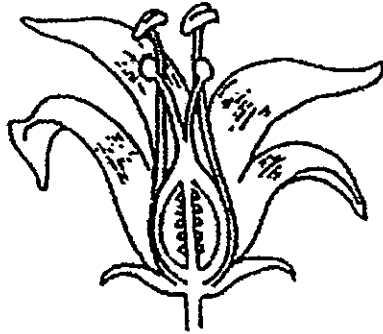

Flower X

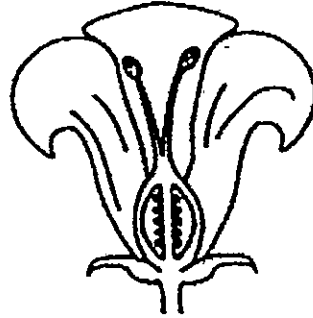

Flower Y

- A Flowers X and Y have female parts
- B Flowers X and Y have one ovule.
- C Flower X does not need to be pollinated to develop into a fruit
- D Flower Y does not need an agent of pollination

Which of the following statements is/are correct about the flowers X and Y?

- (1) A only
- (2) A and B only
- (3) C and D only
- (4) B and D only

15. Jean dropped 2 angšana seeds, X and Y, as shown in the diagram below, from the same height.



Angšana seed X

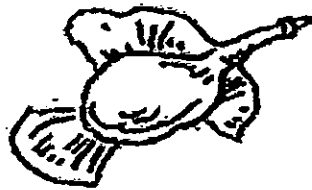

Angšana seed Y

She recorded the time taken by each seed to reach the ground. Which of the following is most likely to be the correct set of records?

	X	Y
(1)	3.4 sec	4.5 sec
(2)	4.5 sec	4.5 sec
(3)	4.5 sec	3.4 sec
(4)	4.5 sec	9.8 sec

16. Study the flowchart shown below about plants P, Q, R, S and T.

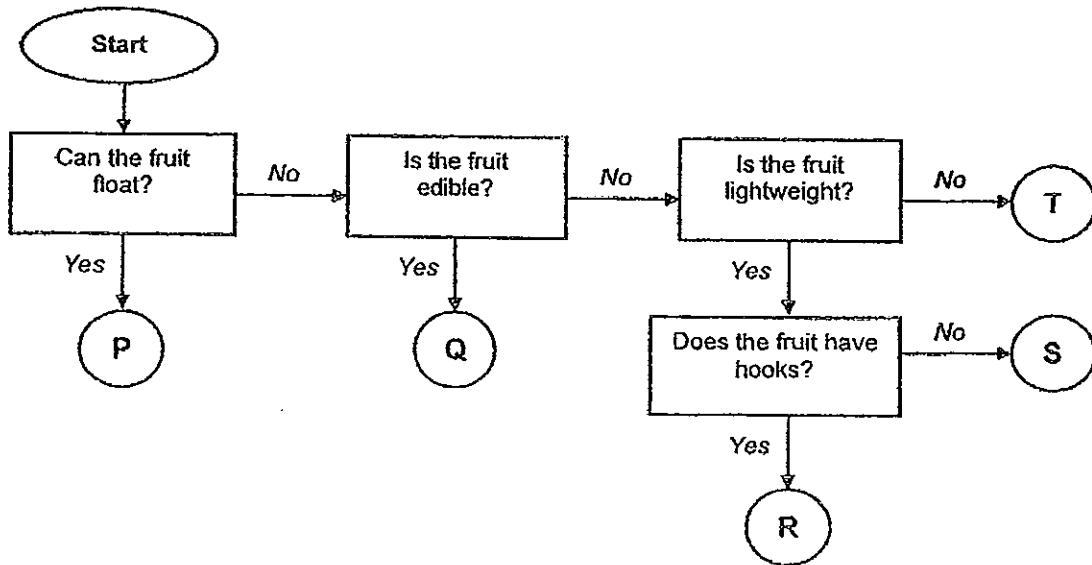

Which of the above plants have fruits that are dispersed by animals?

- |                     |                     |
|---------------------|---------------------|
| (1) Q and R only    | (2) R and S only    |
| (3) P, S and T only | (4) P, Q and R only |

17. Study the flowchart below.

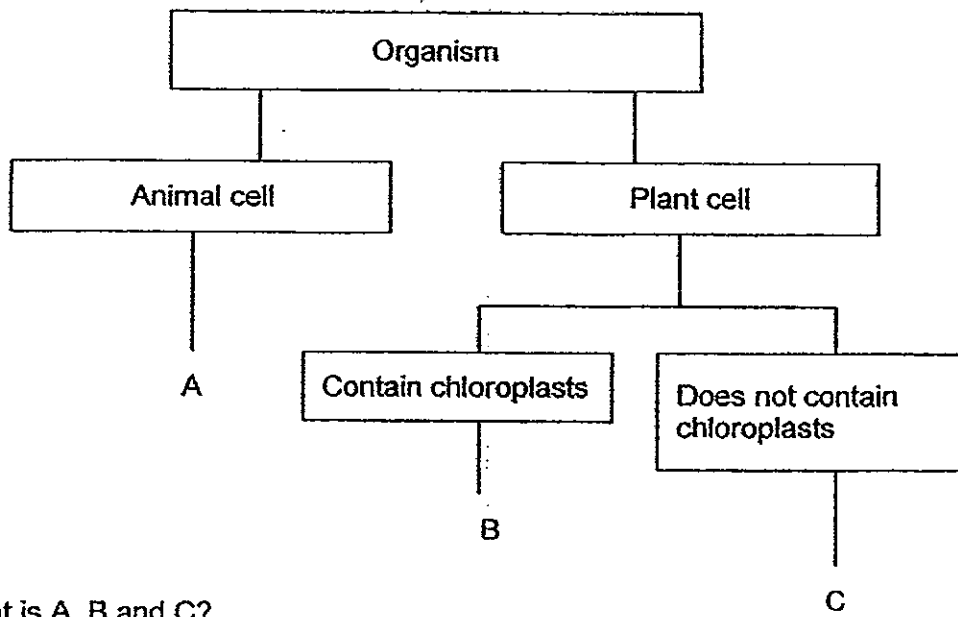

What is A, B and C?

	A	B	C
(1)	Bacteria	Cheek cell	Leaf cell
(2)	Leaf cell	Root cell	Bacteria
(3)	Cheek cell	Leaf cell	Root cell
(4)	Sperm cell	Root cell	Onion skin cell

18. A plant cell was placed in a liquid containing substances X and Y. After a few hours, this is how the plant cell looked like as shown in the diagram below.

Before

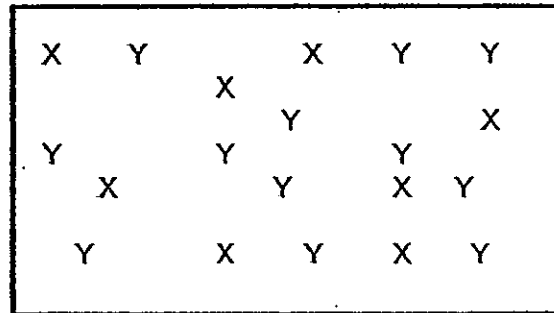

Container A

After a few hours, this is how the plant cell looked like as shown in the diagram below.

After

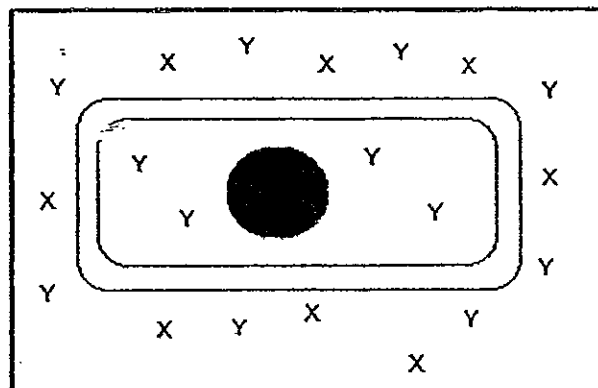

Container A

Which part of the cell is responsible for the observation above?

- (1) Cell wall
- (2) Cytoplasm
- (3) Chloroplast
- (4) Cell membrane

19. The flow chart below shows the different properties of materials A, B, C and D.

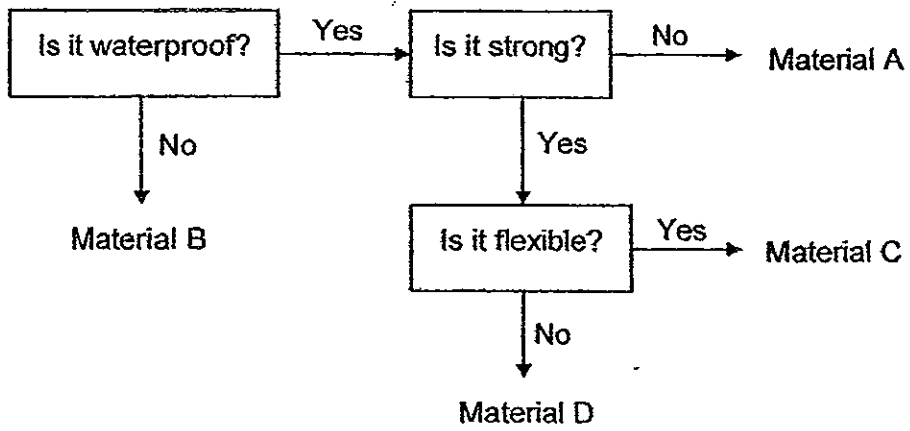

Based on the information above, which one of these materials, A, B, C or D, is suitable to make a water hose to water plants in a garden?

- |       |       |
|-------|-------|
| (1) A | (2) B |
| (3) C | (4) D |

20. The diagram below shows a cooking pot with different parts labelled A, B, C and D.

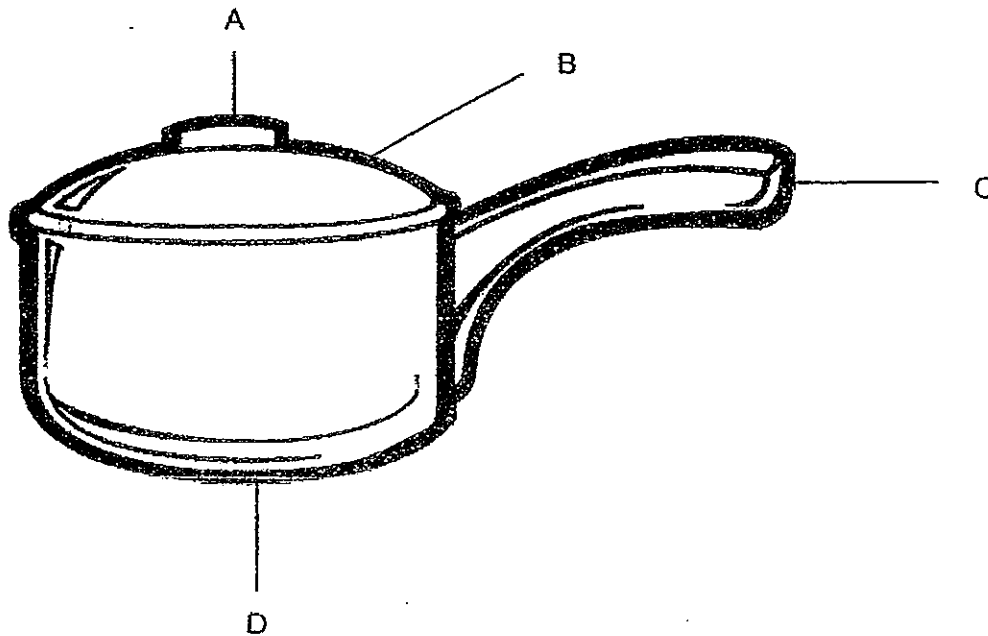

The table below shows four different materials W, X, Y and Z and their properties.

Material	Properties
W	Allows most light to pass through
X	Does not allow most light to pass through
Y	Allows heat to flow through easily
Z	Does not allow heat to pass through easily

Which one of the following shows the best material to be used for each part of the cooking pot?

	Part A	Part B	Part C	Part D
(1)	Y	X	Y	Z
(2)	Z	W	Z	Y
(3)	X	Y	Y	X
(4)	W	Z	Z	W



21. Which one of the following shows the correct state of matter at room temperature?

	<b>Solid</b>	<b>Liquid</b>
(1)	Flour	Water vapour
(2)	Sponge	Ice
(3)	Cheese	Sand
(4)	Stone	Oil

22. The picture below shows a sponge.

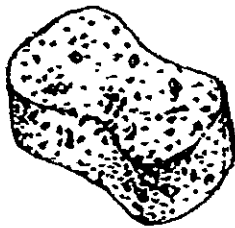

The table below shows the mass of the sponge before and after it was soaked in a basin of water.

Mass of sponge (before)	Mass of sponge (after)
50g	200g

The mass of the sponge increases because \_\_\_\_\_.

- (1) water can be compressed
- (2) water has no definite shape
- (3) the sponge has a definite shape
- (4) water takes up the space in the sponge

23. The diagram below shows the water cycle.

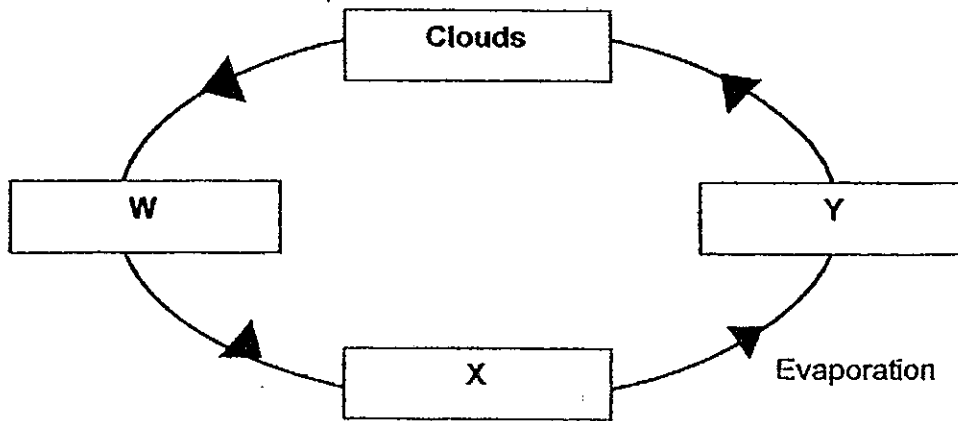

Based on the diagram above, which one of the following is correct?

	W	X	Y
(1)	Water vapour	Lake	Rain
(2)	Lake	Water vapour	Rain
(3)	Rain	Lake	Water vapour
(4)	Lake	Rain	Water vapour

24. Jack could not remove the lid from a bottle, which is at the room temperature of 23°C.

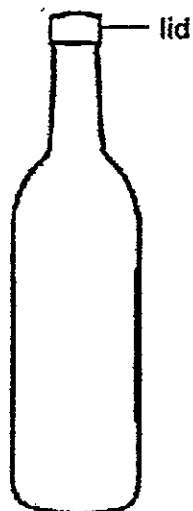

In which container of water should he place the lid in so that it can be removed most easily?

(1)

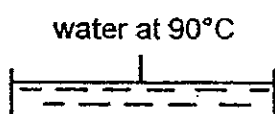

(2)

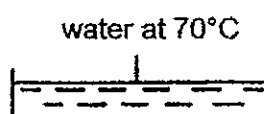

(3)

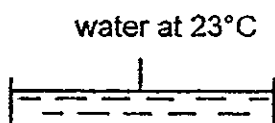

(4)

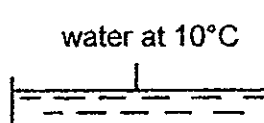

25. The diagram below shows two containers, A and B, containing the same amount of water, placed over a hot stove. The two containers are similar in size and thickness.

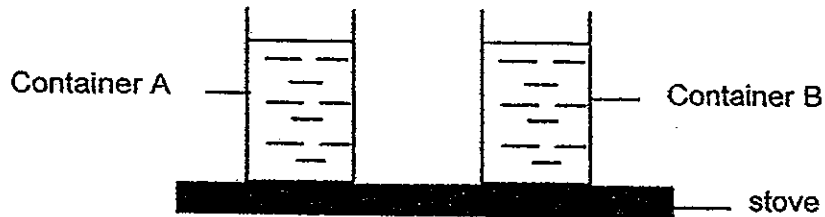

~~Container A is a better conductor of heat than container B.~~ Which one of the following shows the correct amount of water remaining in the containers after 20 minutes has passed?

(1)

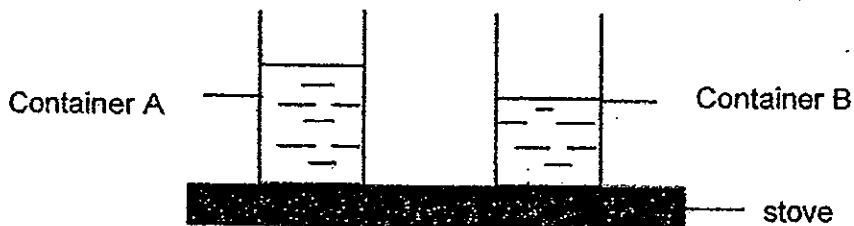

(2)

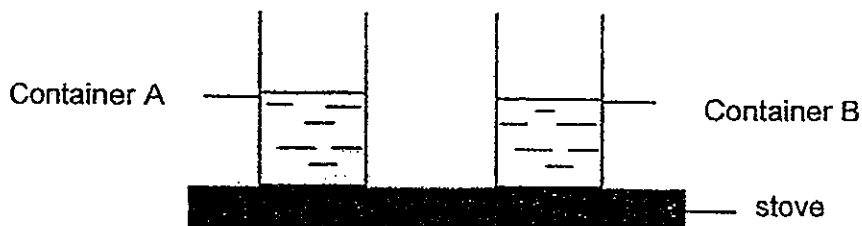

(3)



(4)

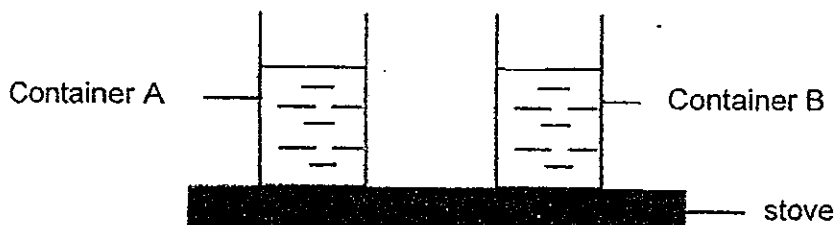

26. The diagram below shows seawater being heated in flask A. After 5 minutes, substance X is found in flask B.

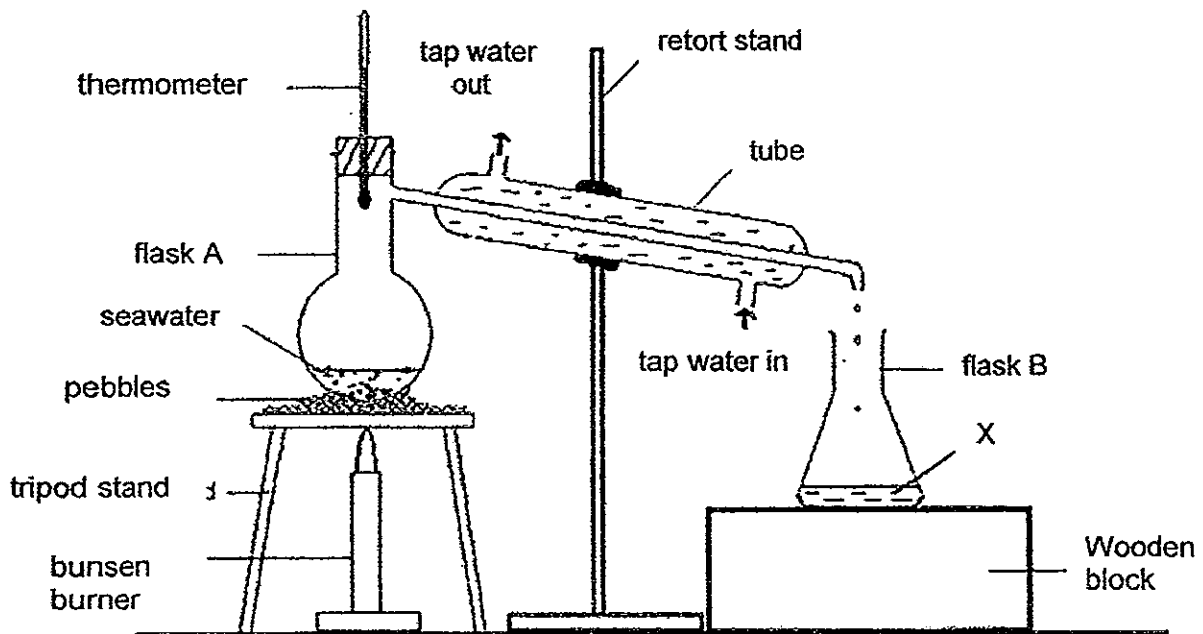

Based on the diagram above, which process(es) is/are responsible for substance X being formed?

- (1) Boiling only
- (2) Evaporation only
- (3) Condensation only
- (4) Evaporation and condensation

- 27 The diagram below shows a lamp placed at position B and Object X placed at position E. When the lamp was switched on, a shadow was cast on the screen.

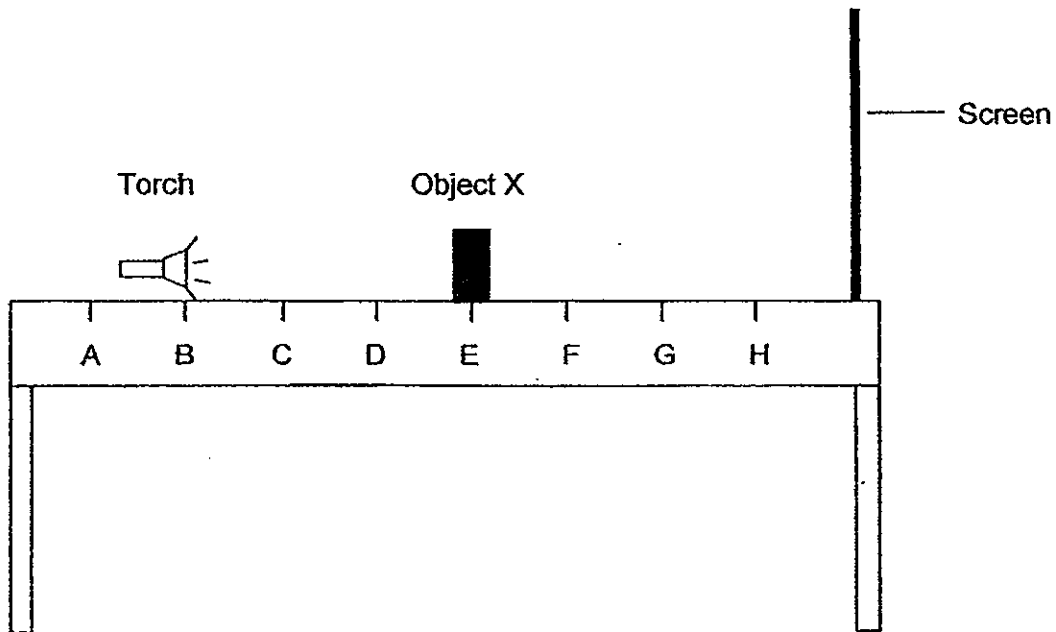

Which one of the following arrangement would cast the largest shadow on the screen?

	Position of lamp	Position of object X
(1)	C	G
(2)	B	H
(3)	E	F
(4)	A	B

28. Sally noticed that the length of the shadow of flag pole changed as the day progressed. The diagram below shows a flag pole and its shadow at a certain time of the day.

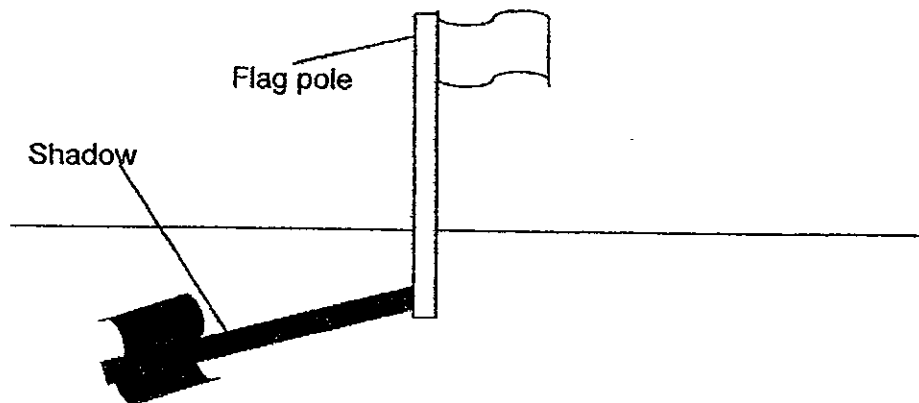

Which one of the following graphs shows the correct change in length of the flag pole's shadow between 7 am and 7 pm?

(1)

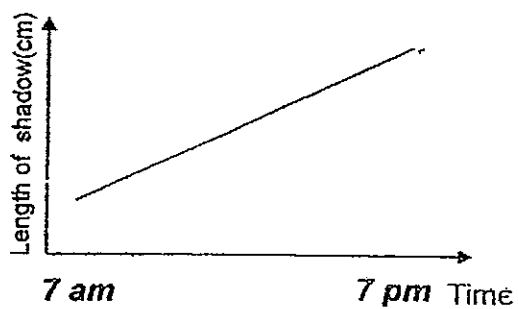

(2)

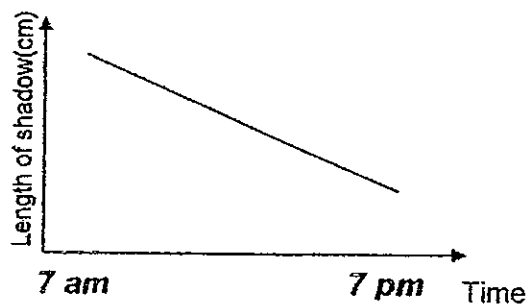

(3)

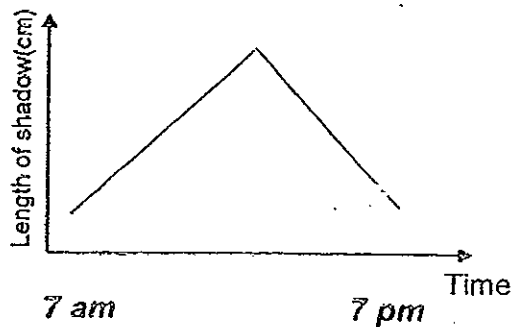

(4)

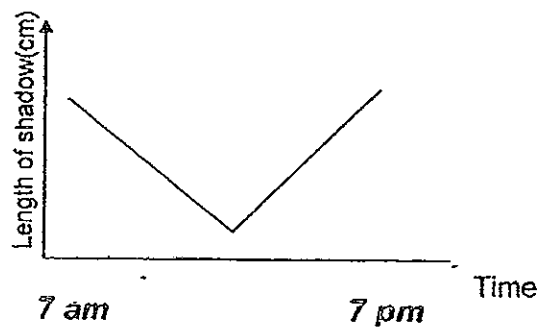

29. Rita heated a beaker of water over a flame for a while before it was left on a table in a room. The graph below shows the change in temperature of the beaker of water over a period of 40 minutes.

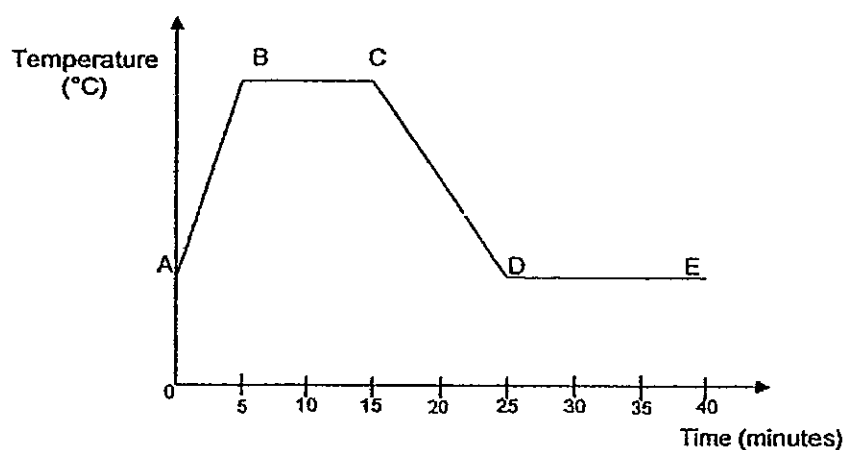

Which one of the following statements is correct?

- (1) The water lost heat to the surrounding air from point C to D.
- (2) The water gained heat from the flame only during the first five minutes.
- (3) The heat source was removed from the beaker of water at the fifth minute.
- (4) The time taken for water to reach room temperature from boiling point is about 25 minutes.



30. Betty held a setup in her hands, as shown in the picture below.

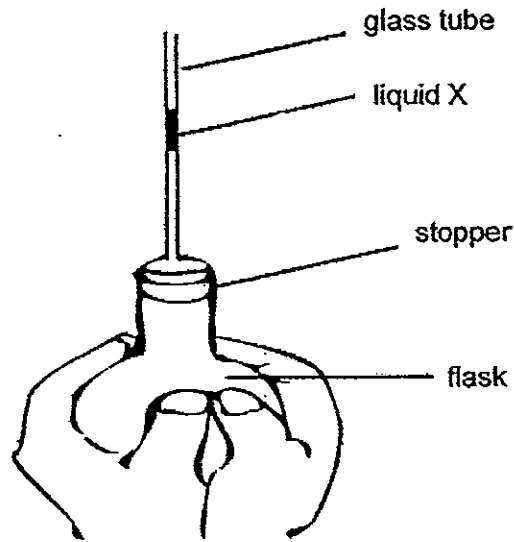

After holding the flask tightly for a minute, she noticed that a droplet of liquid X moved up the glass tube.

What caused liquid X to move up the glass tube?

- (1) The flask lost heat to the hand and contracted.
- (2) The air in the flask gained heat from the hand and expanded.
- (3) The glass tube lost heat to the surrounding air and contracted.
- (4) The liquid X gained heat from the surrounding air and expanded.

Name: \_\_\_\_\_ Index No: \_\_\_\_\_ Class: P5 \_\_\_\_\_

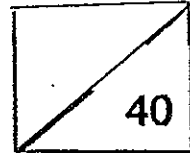

**SECTION B (40 marks)**

For questions 31 to 44, write your answers clearly in the spaces provided.  
The number of marks available is shown in brackets [ ] at the end of each question or part question.

31. Steve carried out an experiment using organisms A. 30 organisms A were put in the middle of dish X. After 1 hour, the number of organisms A in each section of Dish X was counted.

He repeated the experiment replacing Dish X with Dish Y and Dish Z respectively using the same group of organisms A.

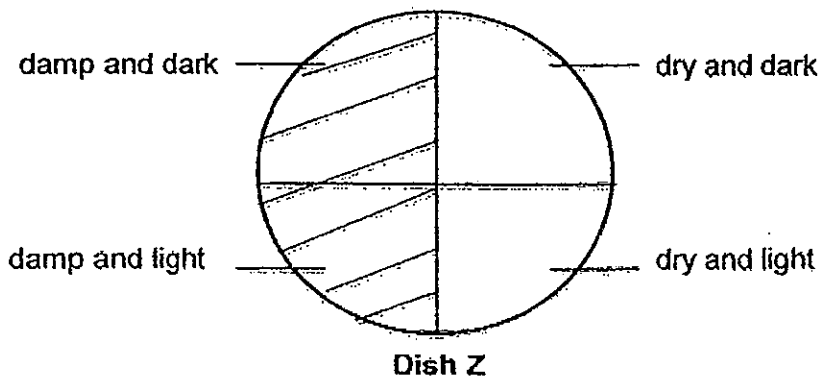
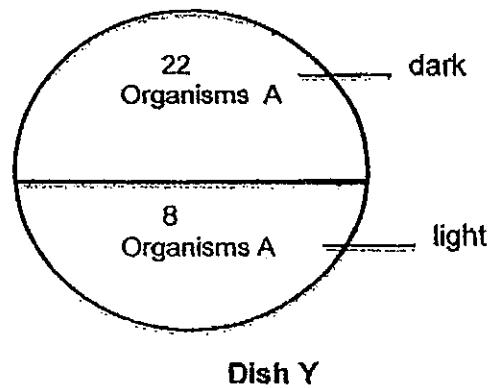
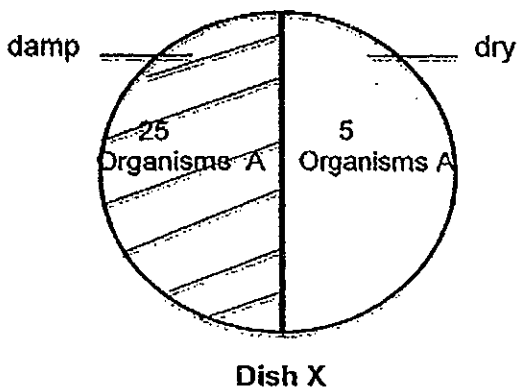

- (a) Based on the observation in Dish X and Y, what characteristic of living things did Organisms A demonstrate? [1]
- (b) Name the area of Dish Z where most Organism A would be found after 1 hour. [1]

Score	2
-------	---

32. Study the classification diagram as shown below carefully. Each animal is represented by a letter, D, E, F, G and H.

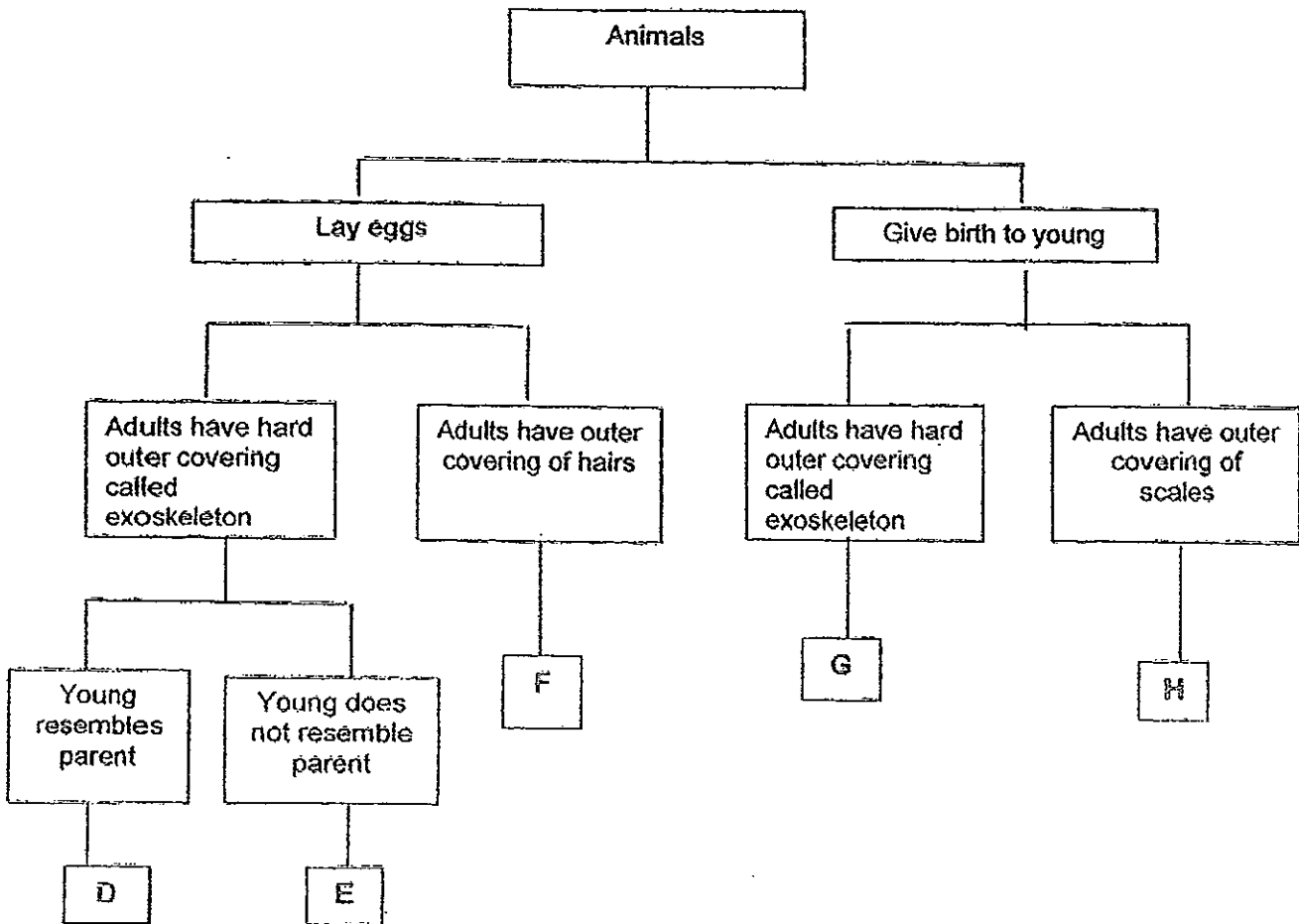

(a) Which letter, D, E, F, G and H, would a beetle belong to? - [1]

---

(b) Which animal(s), D, E, F, G or H is/are mammals? [1]

---

(c) Based on the information provided in the classification chart above, state a difference between animals F and H. [1]

---



---

33. Study the diagram below carefully. The letters, A, B and C, represent the parts of this plant.

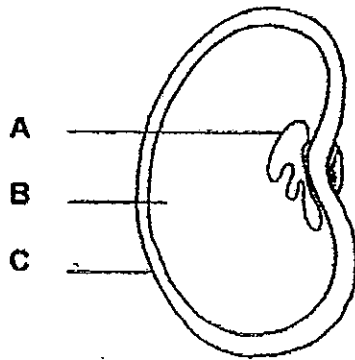

- (a) Which part of the seed, A, B or C, provides food during germination? [1]

---

The diagram below shows the growth of a seed and its stages, V, W, X, Y and Z.

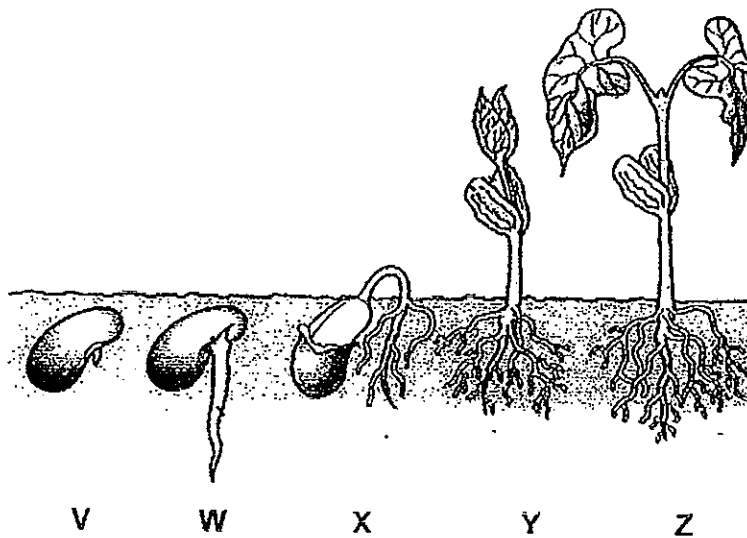

- (b) At which stage(s) can the seedling start to make its own food? Give a reason for your answer. [2]

---



---

34. Insects X and Y are agents of pollination.  
 Insects X have a good sense of smell but cannot recognise the colour red.  
 Insects Y, on the other hand, have a poor sense of smell and have no problem recognising the colour red.

Luke went into his garden and made the following observations:

Plant	Observations
A	Flowers are bright red. Many insects X are seen flying around the flowers.
B	Flowers have huge, red petals. Many insects Y are seen flying around the flowers.
C	Flowers are red and tiny. Many insects X and Y are seen flying around the flowers.

Based on Luke's observations above, put a tick (✓) in the appropriate boxes below to indicate whether each of the flowers is sweet-smelling, odourless or not possible to tell. [3]

	Sweet-smelling	Odourless	Not possible to tell
Flowers of Plant A			
Flowers of Plant B			
Flowers of Plant C			

Score	3
-------	---

35. The following table shows the comparison between sexual reproduction in humans and in flowering plants.

Complete the table below by writing the correct word in each blank [2]

	Humans	Flowering plants
Where female sex cell is produced	Ovary	Ovary
Where male sex cell is produced	(a)i _____	Anther
After fertilisation	A fetus will develop in the (a)ii _____	The (b)i _____ will develop into a (b)ii _____

Score	2
-------	---

36. Study the physical characteristics of the fruits from Plant X, Y and Z below.

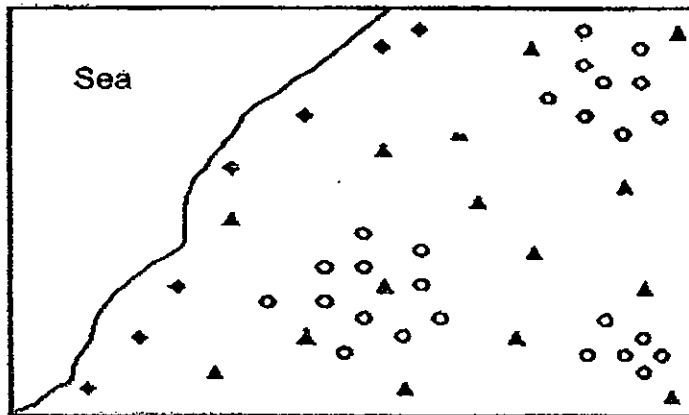
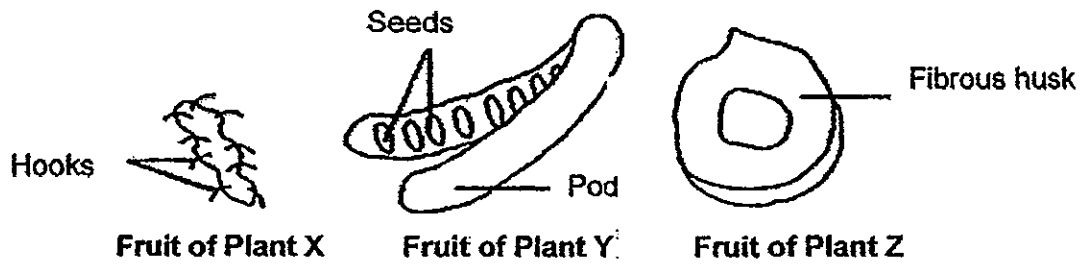

The map above shows the distribution of Plants X, Y and Z represented by the symbols

(a) Which of the following symbols most likely represents Plants X, Y or Z? [1]

(i) ○ : \_\_\_\_\_ (ii) ▲ : \_\_\_\_\_

(b) Plant Y disperses its seeds by splitting open when it is ripe. What is the disadvantage of such method of seed dispersal compared to the other methods? [1]

---



---

(c) How does the physical characteristic of the fruit of plant Z help during seed dispersal? [1]

---



---

Score	3
-------	---

37. The diagram below shows 2 cells, A and B. Cell B has a certain part removed from it as shown below.

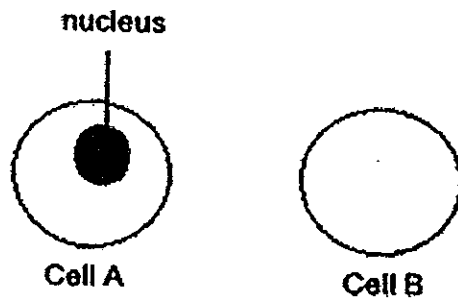

- (a) Which cell is not able to perform cell division? Give a reason for your answer. [1]

---



---

The diagram below shows a cell taken from a mango tree.

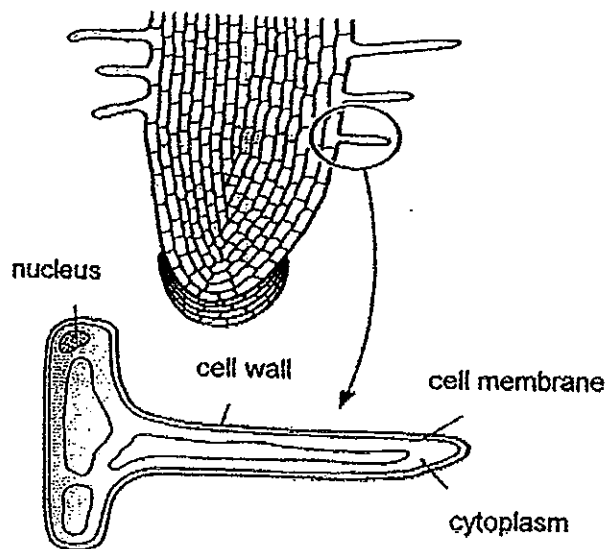

From the diagram above,

- (b) Which part of the mango tree is the cell most likely taken from? [1]

---

- (c) Is the cell shown above capable of making food for the plant? Give a reason for your answer. [1]

---



---

Score	3
-------	---



38. Mr Tan plans to install a blind at the balcony of his new apartment. There are no windows installed at the balcony but there are iron grilles instead. The intended purpose of the blind is to cut down the glares from the sun and yet allow the house to receive some natural light. The blind must also be able to withstand windy and rainy weather.

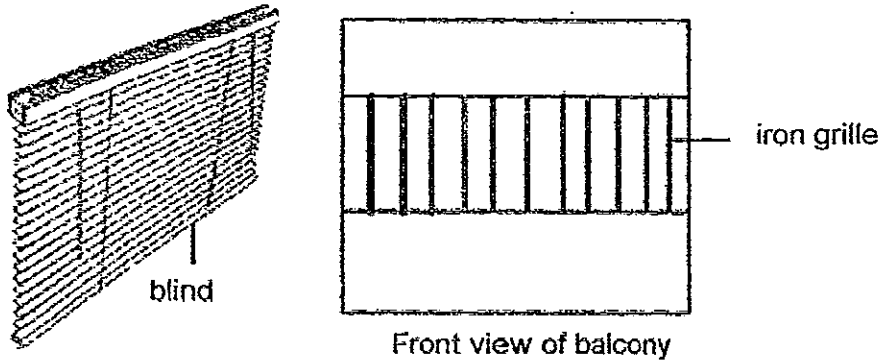

The table below shows the properties of Material A, B, C and D respectively.

	Transparent	Translucent	Waterproof	Strong
Material A		√		
Material B			√	√
Material C		√	√	√
Material D	√		√	

- (a) Based table above, which materials, A, B, C or D, is most suitable to make into the blind that serves the purpose stated? Give a reason for your answer. [2]

---



---

- (b) Mr Tan's neighbour remarks that iron is not suitable to make into window grilles in humid climate as it rusts easily. Rusting of iron happens when the iron comes in contact with oxygen and water.

Suggest what can be done to the iron grilles to prevent it from rusting. Give a reason for your answer. [1]

---



---

Score	3
-------	---

39. Hillary lowered Cup A and Cup B into a tank of water, as shown in Diagram 1 below.

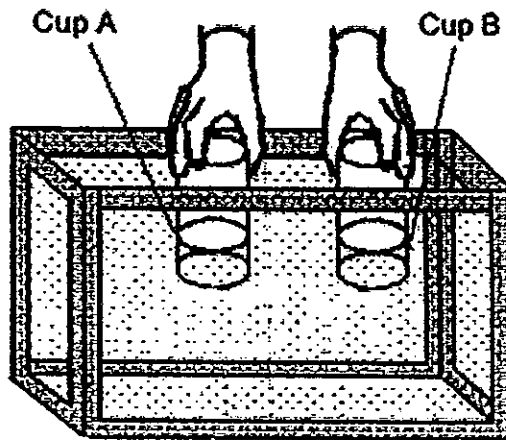

Diagram 1

She then slowly tilted Cup A as shown in Diagram 2 below.

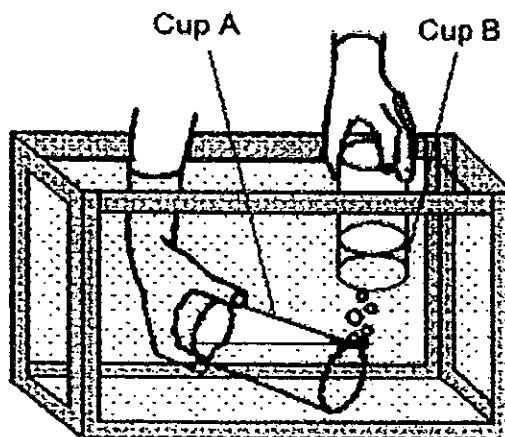

Diagram 2

- (a) What would happen to the water level in cup B?  
Give a reason for your answer.

[2]

Score	2
-------	---

Continue from Question 39.

The diagram below shows an inflated balloon placed over a beaker on one side of a balance, and object X on the other side of the balance.

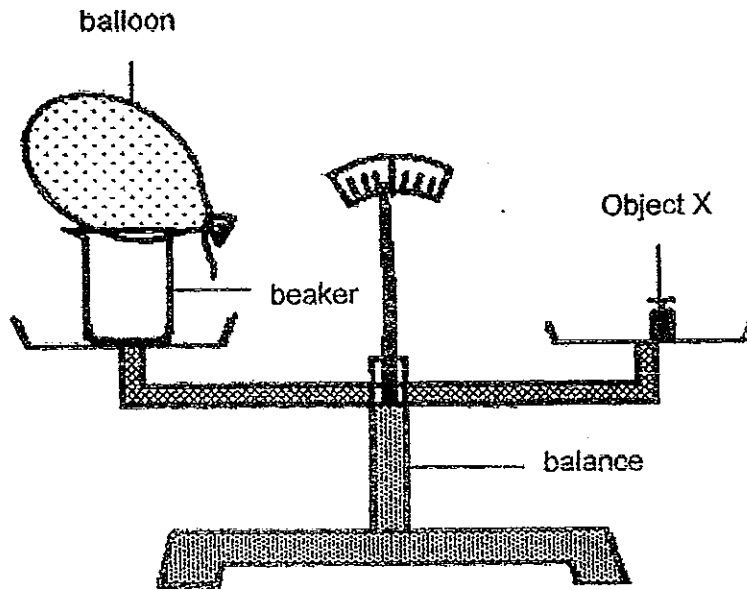

When the balloon was removed, the balance was observed to tilt downwards towards the side with object X on it.

- (b) Based on the observation stated, what conclusion can you draw about the property of air? [1]

---

---

---

Score	1
-------	---

40. Felicia heated two liquids, A and B, of the same volume and in identical containers over an identical amount heat source at the same time and plotted a graph as shown below.

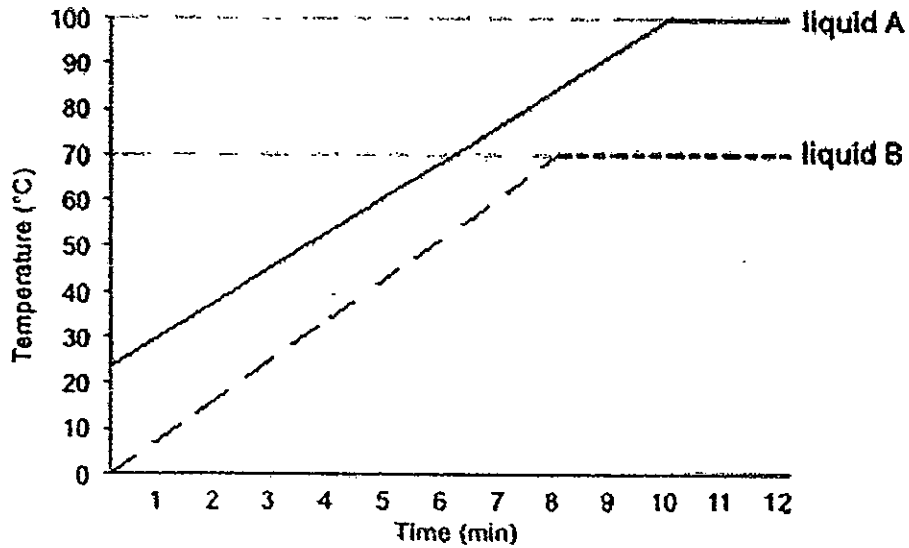

- (a) If Felicia continued heating the two containers until one of them became dry, which liquid, A or B, will still be left in the other container? [1]

---

- (b) Give a reason for your answer in (a). [1]

---

---

---

Score	2
-------	---

41. Siew Li prepared the following set-ups using two containers of the same mass, each filled with 500 ml of water and two identical springs attached to a retort stand.

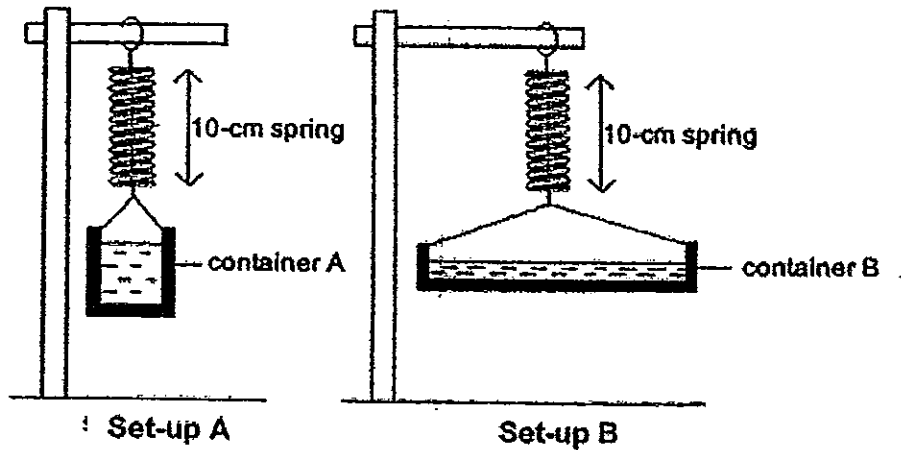

She left set-ups A and B near a window for 24 hours. At the end of the experiment, she noticed a change in the length of the springs as shown below.

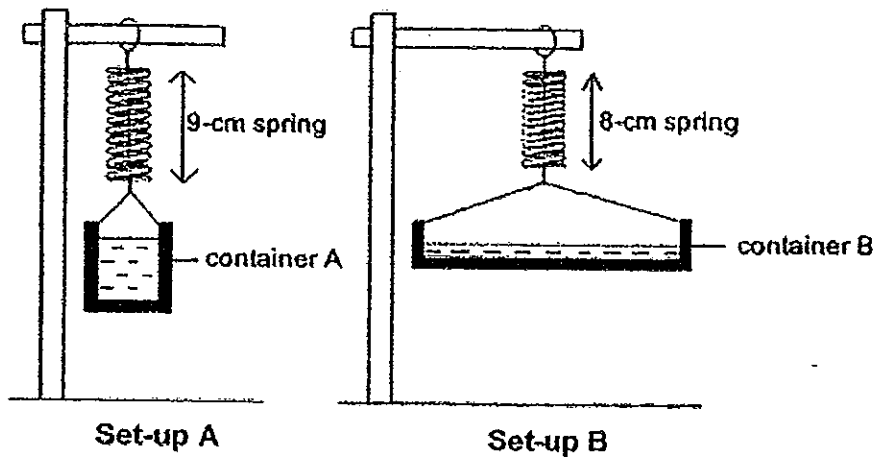

- (a) Based on the above observations, compare the length of the springs in both set-ups at the end of the experiment. [1]

---

- (b) Give a reason for your answer in (a). [2]

---



---

42. Jean prepared a shadow puppet show for her classmates. She made the puppet cut-out using a piece of cardboard. Her audience, seated on the other side of the screen could not see her or the puppets made by her. All they could see was a dark shadow on the screen.

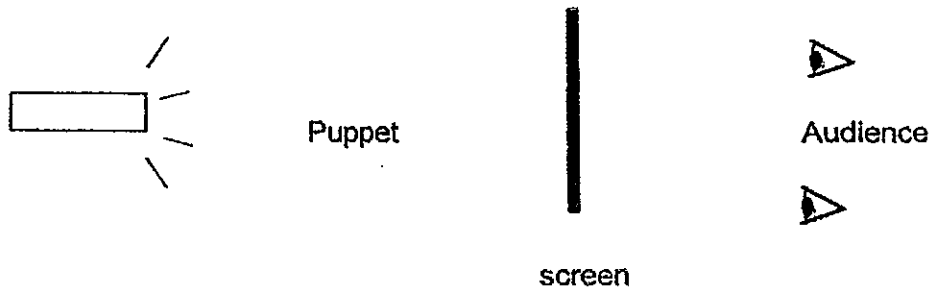

The diagram below shows the shadow cast by the puppet created by Jean.

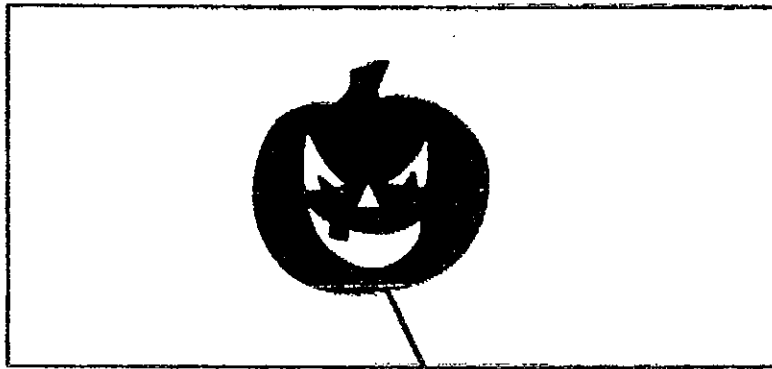

- (a) In order for the audience to see the shadow of the puppet from the other side of the screen, what type of material should the screen be made of? Give a reason for your answer. [1]
- 
- 
- (b) Explain clearly how the shadow of the puppet was formed on the screen. [2]
- 
-

43. Jenny put equal amount of ice cubes in 2 beakers. She placed one beaker in the sun and another in the room. The diagrams below show the set-up of her experiment.

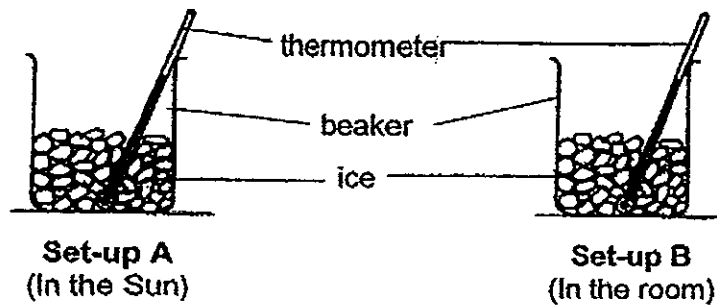

She measured and recorded the temperature of the content in each beaker for 10 minutes. She observed that the temperature in both beakers remained at  $0^{\circ}\text{C}$  even though some of the ice had melted.

- (a) (i) Why did the temperature in set-up A not increase when it gained heat from the sun? [1]

---

---

- (a) (ii) When would the temperature of the content in each beaker start to increase? [1]

---

---

Score	2
-------	---

Continue from Question 43

Peter heated a 200-g-iron disc and a 20-g-iron disc to 100°C. Then, he transferred the hot iron discs into containers A and B which contained equal amount of water at room temperature, at the same time.

The diagrams below show the set-ups of Peter's experiment.

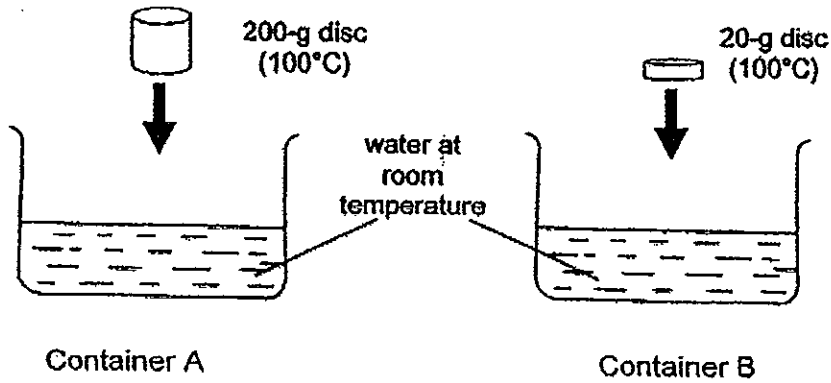

(b) In which container, A or B, would the thermometer record a higher temperature of water after 3 minutes? Give a reason for your answer. [2]

---

---



44. Amy hung two similar metal balls, Ball X and Ball Y, on a balanced rod. Ball X was heated as shown in the diagram below.

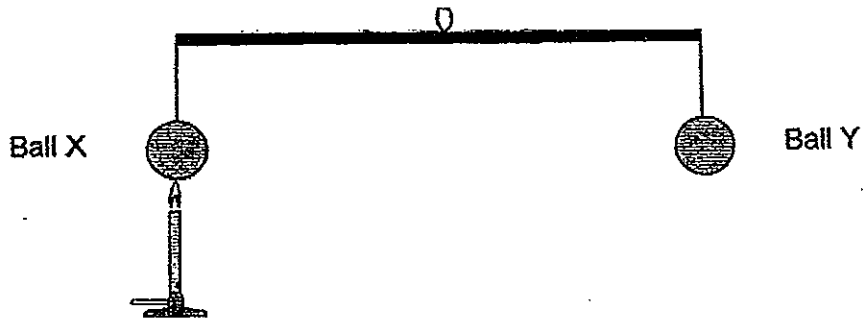

- (a) Amy predicted that the ball X will tilt downward after being heated. Do you agree with her? Give a reason for your answer. [2]

---



---

Immediately after the experiment, Amy wanted to return the metal balls in the storage container as shown below. She managed to put Ball Y into the container but Ball X could no longer go through the opening of the container.

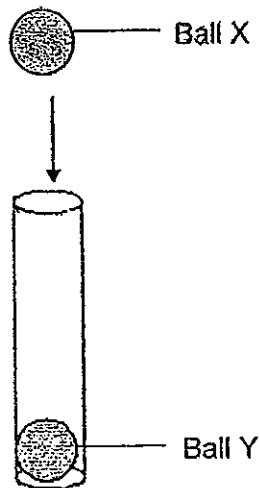

- (b) Give a reason for the above observation on Ball X. [1]

---



---

- The End -

Score	3
-------	---



# ANSWER SHEET

**EXAM PAPER 2012**

**SCHOOL : REFFLES GIRLS'  
SUBJECT : PRIMARY 5 SCIENCE**

**TERM : SA1**

Q1	Q2	Q3	Q4	Q5	Q6	Q7	Q8	Q9	Q10	Q11	Q12	Q13	Q14	Q15	Q16	Q17
3	2	2	2	2	2	4	2	2	3	3	3	3	1	3	1	3

Q18	Q19	Q20	Q21	Q22	Q23	Q24	Q25	Q26	Q27	Q28	Q29	Q30
4	3	2	4	4	3	1	3	4	4	4	1	2

31)a) Living things respond to changes.  
b) Damp and Dark.

32)a) E.  
b) F.  
c) Animal F lay eggs but Animal H give birth to young.

33)a) Part B.  
b) Stage Y. The young plant in stage Y has leaves which trap (absorb) sunlight.

34) A: Sweet-smelling.    B: Not possible to tell    C: Sweet-smelling

35)a) i) testes    ii) womb  
b) i) ovules/ovary    ii) seeds/fruit

36)a) i) Y    ii) X  
b) The seeds would be dispersed at the same distance and would land at the same place, causing overcrowding and fight for sunlight and nutrients.  
c) The fibrous husk contains trapped air which allows the fruit of plant Z to float on water.

- 37)a) Cell B. The nucleus helps the cell to perform cell division, the nucleus in cell B is removed thus, It will not be able to perform cell division.  
 b) The roots of the mango tree.  
 c) No, it is not capable of making food. The cell does not have chloroplasts which contain chlorophyll to trap sunlight for the plant to make food.
- 38)a) A blind must be transparent that helps to reduce glare, it is waterproof so that water will not be able to enter and must be strong so if there is a strong wind the blind would not tear easily.  
 b) Mr Tan can paint the iron grilles to prevent water and oxygen from coming in contact with the iron grills.
- 39)a) The water level in cup B would decrease. The bubbles contain air that would occupy up space in cup B, causing some water to escape for the air to come in and occupy the space previously occupied by the water and make the water level in cup B to decrease.  
 b) Air has mass.
- 40)a) Liquid A.                      b) Liquid A has a higher boiling point than liquid B.
- 41)a) The length of spring in set-up A was longer than the spring in set-up B.  
 b) The exposed surface area of water in container B was larger than the exposed surface area of water in container A thus, the water in container B would evaporate faster. Water has mass. Since the water in container B evaporated so the mass of the container B would be lighter than before.
- 42)a) The screen should be made from a translucent material. Translucent material allows some light to pass through and then enter the audiences eye.  
 b) The puppet is between the screen and light source. The puppet was made of an opaque material which does not allow any light to pass through so light cannot pass through the puppet.
- 43)a) i) The ice had not melted.                      ii) After all the ice melted.  
 b) Container A. The iron disc in container A was bigger and had container more heat energy than container B that can heat the water faster and record a higher temperature.
- 44)a) No. Even though Ball X gained heat and expanded, its mass still does not change and would not tilt down ward after being heated.  
 b) Ball X expanded and became bigger thus, Ball X could no longer go through the opening of the container.