



NANYANG PRIMARY SCHOOL  
SECOND SEMESTRAL EXAMINATION  
2013

**PRIMARY 5  
MATHEMATICS  
PAPER 1**

**DURATION: 50 MINUTES**

<b>Booklet A</b>	<b>/ 20</b>
<b>Booklet B</b>	<b>/ 20</b>

<b>Paper 1 Total: / 40</b>
--------------------------------

Name: \_\_\_\_\_ (       )

Class: Primary 5 (       )

Date: \_\_\_\_\_

Parent's Signature: \_\_\_\_\_

Any query on marks awarded should be raised by **6 November 2013**.  
We seek your understanding in this matter as any delay in the  
confirmation of marks will lead to delays in the generation of results.

**DO NOT OPEN THIS BOOKLET UNTIL YOU ARE TOLD TO DO SO.**

**FOLLOW ALL INSTRUCTIONS CAREFULLY.**

**ANSWER ALL QUESTIONS.**

**YOU ARE NOT ALLOWED TO USE A CALCULATOR.**

**PAPER 1 (BOOKLET A)**

Questions 1 to 10 carry 1 mark each. Questions 11 to 15 carry 2 marks each. For each question, four options are given. One of them is the correct answer. Make your choice (1, 2, 3 or 4). Shade the oval (1, 2, 3 or 4) on the Optical Answer Sheet.

(20 marks)

---

1 Which one of the following when rounded off to the nearest thousand is 300 000?

(1) 301 499

(2) 300 500

(3) 299 786

(4) 290 000

2 Mr Tang had 6320 marbles. He bought another 80 marbles and packed all the marbles equally into 8 bags. How many marbles were there in each bag?

(1) 780

(2) 790

(3) 791

(4) 800

- 3 What is the missing numerator in the box below?

$$\frac{5}{6} + \frac{1}{12} = \frac{\boxed{?}}{12}$$

- (1) 12  
(2) 11  
(3) 6  
(4) 4
- 4 In the number line below, A represents  $\frac{1}{5}$ , C represents  $\frac{1}{3}$  and  $AB = BC$ . What is the fraction represented by B?

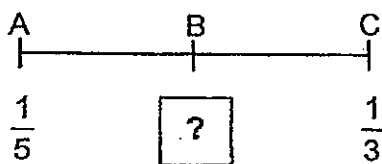

- (1)  $\frac{1}{4}$   
(2)  $\frac{1}{15}$   
(3)  $\frac{2}{4}$   
(4)  $\frac{4}{15}$

5 A baker used 240.08 kg of flour in 10 weeks. How much flour did she use in a week if she used the same amount of flour every week?

- (1) 24.008 kg
- (2) 24.080 kg
- (3) 2400.8 kg
- (4) 24 008 kg

6 Given that the base of triangle FGH is FH, find its corresponding height.

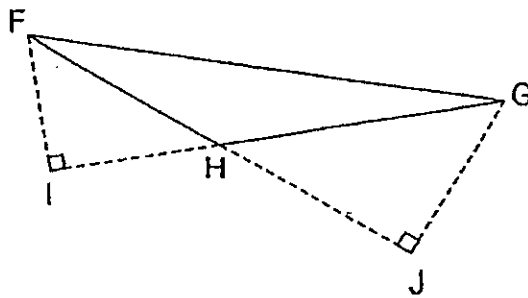

- (1) HJ
- (2) IF
- (3) IH
- (4) JG

7 Which one of the following is an equivalent ratio to 8 : 24?

(1) 1 : 4

(2) 1 : 6

(3) 2 : 6

(4) 2 : 8

8 What is the volume of a cube of sides 7 cm?

(1)  $7 \text{ cm}^3$

(2)  $21 \text{ cm}^3$

(3)  $49 \text{ cm}^3$

(4)  $343 \text{ cm}^3$

9 What is the capacity of a tank measuring 50 cm by 30 cm by 30 cm?  
Express your answer in litres.

(1) 45 l

(2) 450 l

(3) 4500 l

(4) 45 000 l

10 Mrs Tan paid \$3150 for a piano after a discount of 30%. What was the price of the piano before the discount?

- (1) \$1350
- (2) \$4500
- (3) \$7350
- (4) \$10 500

11 Arrange the fractions below in increasing order.

$$\frac{5}{6}, \frac{1}{2}, \frac{4}{9}$$

- (1)  $\frac{1}{2}, \frac{4}{9}, \frac{5}{6}$
- (2)  $\frac{1}{2}, \frac{5}{6}, \frac{4}{9}$
- (3)  $\frac{4}{9}, \frac{1}{2}, \frac{5}{6}$
- (4)  $\frac{5}{6}, \frac{1}{2}, \frac{4}{9}$

12 A rectangular tank measuring 30 cm by 40 cm by 40 cm is  $\frac{3}{4}$  filled with water. How many more litres of water are needed to fill the tank to its brim?

(1) 12

(2) 24

(3) 32

(4) 36

13 The average mass of Farhanah, Kumar and Terry is 65 kg. The average mass of Kumar and Terry is 74 kg. Find the mass of Farhanah.

(1) 27 kg

(2) 47 kg

(3) 83 kg

(4) 121 kg

14 Which one of the following is an equilateral triangle?

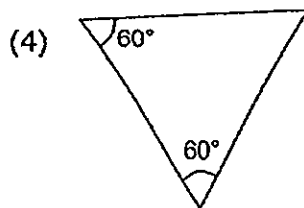
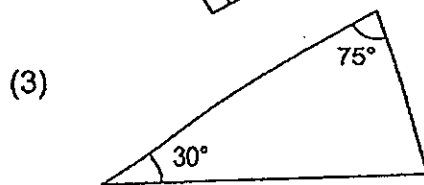
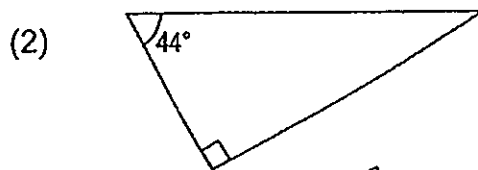
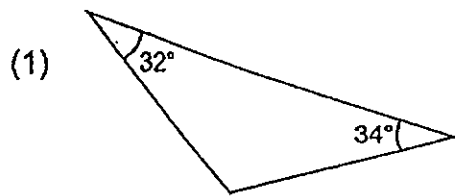

15 Look at the pattern below.

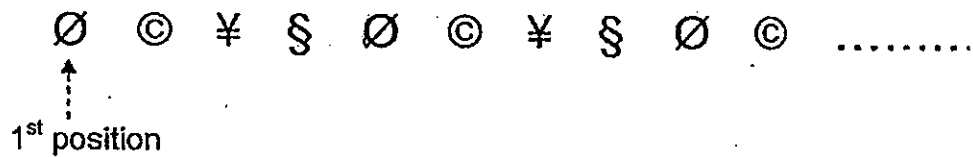

In which one of the positions will the symbol ' $\yen$ ' appear in?

- (1) 185<sup>th</sup>
- (2) 186<sup>th</sup>
- (3) 187<sup>th</sup>
- (4) 188<sup>th</sup>



Name: \_\_\_\_\_ (            ) Class: Pr 5 (            )

P5 SA2 2013

**PAPER 1 (BOOKLET B)**

Questions 16 to 25 carry 1 mark each. Write your answers in the spaces provided. For questions which require units, give your answers in the units stated.

(10 marks)

---

16 Fill in the missing pair of brackets in the equation below.

$$42 + 8 \times 8 \div 4 = 100$$

---

17 In a class,  $\frac{1}{4}$  of the children are boys.  $\frac{1}{2}$  of the boys and  $\frac{1}{3}$  of the girls wear spectacles. What fraction of the children in the class wear spectacles? Leave your answer in the simplest form

Ans: \_\_\_\_\_

---

18 Janet has 8 l of fruit punch and some orange juice. She has 4 l more fruit punch than orange juice. What is the ratio of the amount of orange juice to the amount of fruit punch? Express your answer in its simplest form.

Ans: \_\_\_\_\_

19  $21 : 28 = 9 : \boxed{?}$

What is the missing number in the box?

Ans: \_\_\_\_\_

---

- 20 The figure below is made up of some unit cubes. How many unit cubes are there?

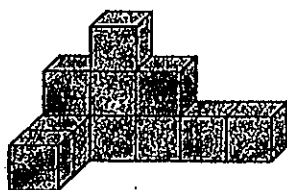

Ans: \_\_\_\_\_

---

- 21 The figure below shows a cuboid with a square base of sides 5 cm and a height of 8 cm. What is the volume of the cuboid?

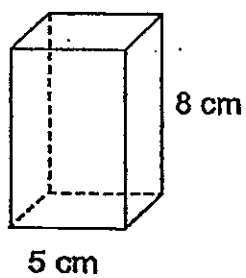

Ans: \_\_\_\_\_  $\text{cm}^3$

---

- 22 In a class of 40 pupils, 24 of them were boys. What percentage of the pupils were girls?

Ans: \_\_\_\_\_ %

---

- 23 Express 1.8 as a percentage.

Ans: \_\_\_\_\_ %

---

- 24 Mr Lim earns \$3000 monthly. He saves 20% of it and spends the rest. How much does he spend every month?

Ans: \$ \_\_\_\_\_

---

- 25 The figure below is not drawn to scale. Find  $\angle a$ .

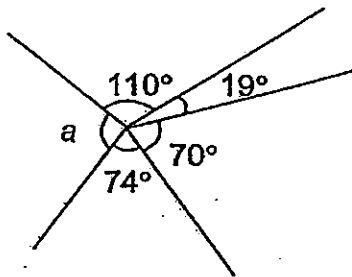

Ans: \_\_\_\_\_ °

---

Questions 26 to 30 carry 2 marks each. Show your working clearly in the space provided for each question and write your answers in the spaces provided. For questions which require units, give your answers in the units stated.

(10 marks)

---

- 26 The mass of 1 magazine and 2 identical books is 4 kg 500 g. The mass of 2 identical magazines and 1 such book is 3 kg. What is the mass of 1 such magazine and 1 such book? Leave your answer in kg.

Ans: \_\_\_\_\_ kg

---

- 27 Akkash bought 12 notebooks and 7 pens. Each notebook cost \$0.60 and each pen cost twice the amount. How much did he spend altogether? Round off your answer to the nearest dollar.

Ans: \$ \_\_\_\_\_

---

- 28 PQRS is a rectangle. Given that PS = 6 cm, PQ = 10 cm and ST = TR, find the area of triangle SQT.

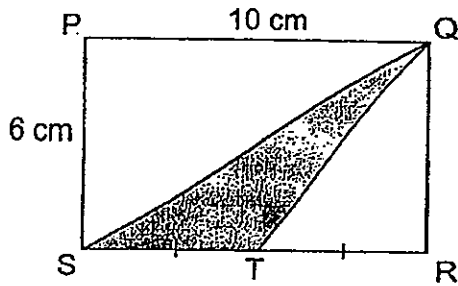

Ans: \_\_\_\_\_ cm<sup>2</sup>

---

- 29 In the figure below, find  $\angle x$ .

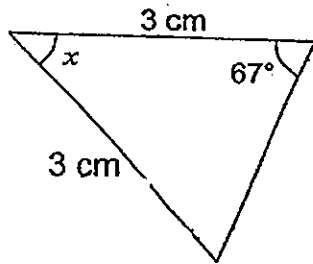

Ans: \_\_\_\_\_

---

- 30 Miss Mok placed 20 tables in the canteen. She labelled the tables from number 1 to 20. How many digits did she write for all the labels?

Ans: \_\_\_\_\_

---

**END OF PAPER**



NANYANG PRIMARY SCHOOL  
SECOND SEMESTRAL EXAMINATION  
2013  
PRIMARY 5  
MATHEMATICS  
PAPER 2

DURATION: 1 HOUR 40 MINUTES

Paper 2 Total	/ 60
GRAND TOTAL	/ 100

Name: \_\_\_\_\_ (       )

Class: Primary 5 (       )

Date: \_\_\_\_\_

Parent's Signature: \_\_\_\_\_

Any query on marks awarded should be raised by **6 November 2013**.  
We seek your understanding in this matter as any delay in the  
confirmation of marks will lead to delays in the generation of results.

DO NOT OPEN THIS BOOKLET UNTIL YOU ARE TOLD TO DO SO.

FOLLOW ALL INSTRUCTIONS CAREFULLY.

ANSWER ALL QUESTIONS.

YOU ARE ALLOWED TO USE A CALCULATOR.

**PAPER 2**

Questions 1 to 5 carry 2 marks each. Show your working clearly in the space provided for each question and write your answers in the spaces provided. For questions which require units, give your answers in the units stated.

(10 marks)

---

- 1 The perimeter of a square is 4 times that of a rectangle. The perimeter of the rectangle is  $1\frac{1}{15}$  m. Find the perimeter of the square. Leave your answer as a mixed number in its simplest form.

Ans: \_\_\_\_\_ m

---

- 2 The ratio of the amount of money Alex had to the amount of money Bala had was 5 : 4. After Alex gave Bala \$15, the ratio became 2 : 7. How much money did Alex have at first?

Ans: \$ \_\_\_\_\_

---

- 3 Mr Lee ordered some dishes that cost \$87 before GST. How much did he have to pay in all after a 7% GST was charged on the cost of the dishes?

Ans: \$ \_\_\_\_\_

---

- 4 In the following figure which is not drawn to scale, EF and GH are straight lines. Given that  $JH = JD$  and  $\angle a = \angle b = \angle c$ , find  $\angle d$ .

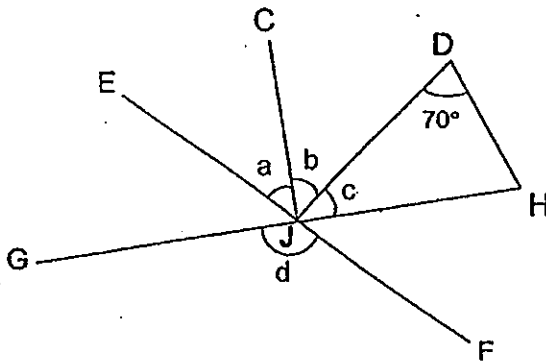

Ans: \_\_\_\_\_ °

---

- 5 The figure below is made up of 2 triangles. Triangle ABC is an equilateral triangle.  $\angle ABD = 126^\circ$  and  $\angle BCD = 70^\circ$ . Find  $\angle BDC$ .

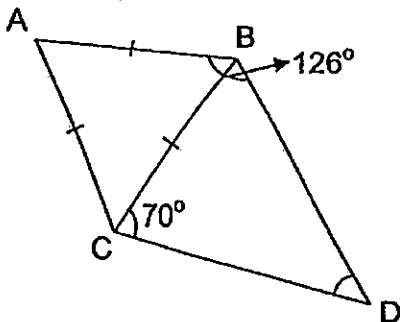

Ans: \_\_\_\_\_ °

---



For questions 6 to 18, show your working clearly in the space provided for each question and write your answers in the spaces provided.  
The number of marks available is shown in brackets [ ] at the end of each question or part-question.

(50 marks)

- 6 ABCD is a square. Point E and F are midpoints of AD and CD respectively. What is the ratio of the shaded area to the unshaded area?

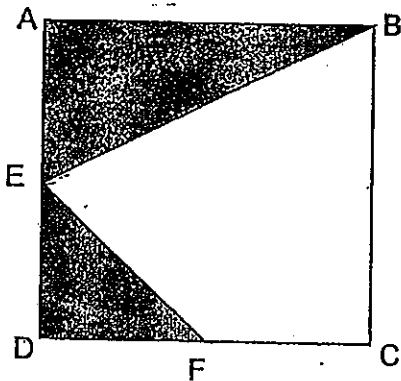

Ans: \_\_\_\_\_ [3]

- 7 A rectangular tank measuring 60 cm by 30 cm by 50 cm was filled with water to a height of 20 cm. A tap was turned on, filling up the tank with water at a rate of  $500 \text{ cm}^3$  per minute. After the tap was turned on for 5 minutes, how much water was in the tank at the end? Express your answer in litres.

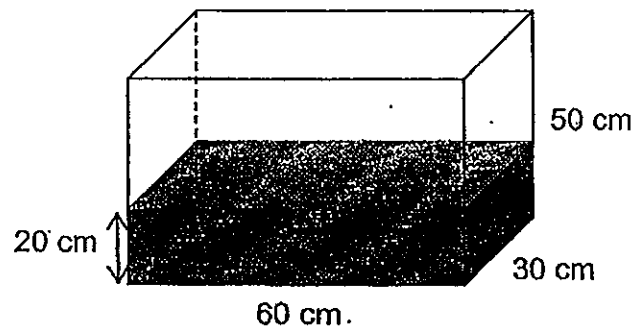

Ans: \_\_\_\_\_ [3]

- 8 In the space below, draw a parallelogram ABCD in which  $AB = 7$  cm,  $AD = 5$  cm and  $\angle ABC = 54^\circ$ . Line AB is given below. [3]

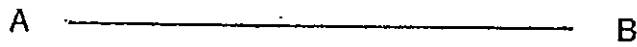

- 9 Ali and May had \$540 altogether. Ali gave 0.2 of his money to May. In return, May gave 0.25 of the total amount of money she had to Ali after receiving the money from him. They then had an equal amount of money. How much money did Ali have at first?

Ans: \_\_\_\_\_ [3]

---

- 10 A group of pupils took part in a quiz and scored an average of 38 marks. When one of the pupils who scored 48 marks was excluded, the average marks would become 36. How many pupils took part in the quiz?

Ans: \_\_\_\_\_ [3]

---

- 11 Mrs Khairul borrowed \$235 200 from a bank to start a business. She had to pay yearly interests to the bank as shown in the table below.

Year	Interest paid per year
1	5% of original borrowed amount
2	4% of original borrowed amount
3 onwards	3% of original borrowed amount

- (a) What was the average monthly interest she paid in the first year?
- (b) What was the total amount of interest she paid for 5 years?

Ans: (a) \_\_\_\_\_ [2]

(b) \_\_\_\_\_ [2]

- 12 Bella, Nette and Rachel had a collection of seashells. Bella and Nette collected  $\frac{7}{10}$  of the seashells. Bella and Rachel collected  $\frac{2}{5}$  of the seashells. Nette and Bella collected 140 seashells altogether.
- (a) How many seashells did the 3 girls collect altogether?
- (b) How many more seashells did Rachel collect than Bella?

Ans: (a) \_\_\_\_\_ [3]

(b) \_\_\_\_\_ [1]

---

- 13 In the figure below,  $KLMN$  is a rectangle of area  $264 \text{ cm}^2$ .  $LM = 12 \text{ cm}$ ,  $NQ = 16 \text{ cm}$  and  $ON = KP = QM$ .  $OL$ ,  $NL$  and  $PQ$  are straight lines. The area of triangle  $RLS$  is  $28 \text{ cm}^2$ . Find the area of the shaded region.

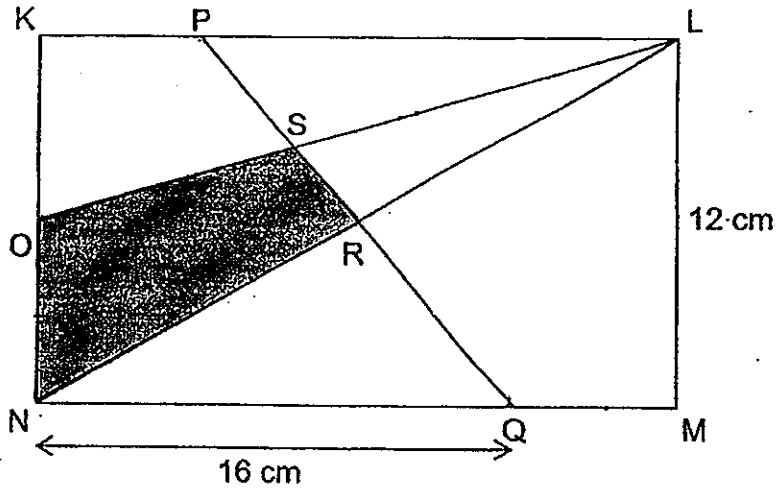

Ans: \_\_\_\_\_ [4]

- 14 There were apples, oranges and pears in the ratio 3 : 5 : 2 in a basket. There were 68 more apples than pears. The apples were sold at 3 for \$1, the oranges were sold at 5 for \$2 and the pears were sold at 40 cents each. What was the total amount of money collected from the sale of all the fruits?

Ans: \_\_\_\_\_ [4]

---



- 15 In the figure below which is not drawn to scale, PQRS is a parallelogram and PSTU is a trapezium. PR and PT are straight lines.  $\angle QRP$  is  $\frac{1}{6}$  of  $\angle QPU$ . Given that  $\angle QRP = 22^\circ$ ,  $\angle PUT = 115^\circ$  and  $\angle PTS = 79^\circ$ .

(a) Find  $\angle PRS$ .

(b) Find  $\angle PTU$ .

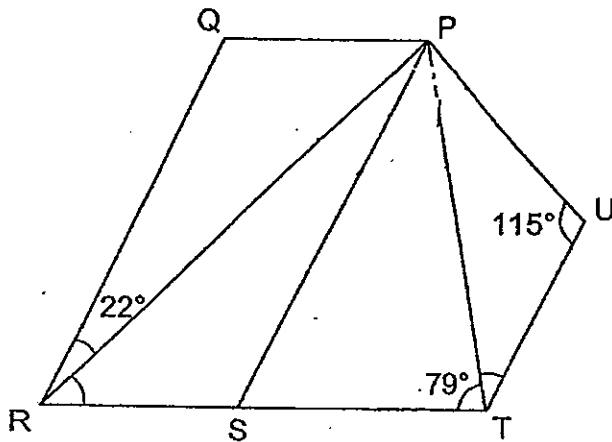

Ans: (a) \_\_\_\_\_ [2]

(b) \_\_\_\_\_ [2]

16 Minah baked some muffins for sale. She put half the muffins equally into 4 trays and the other half equally into 12 boxes. There were 60 muffins in 2 trays and 4 boxes altogether.

(a) How many muffins did Minah bake?

(b) Minah sold all the muffins and collected \$432. How much did she sell each muffin for?

Ans: (a) \_\_\_\_\_ [4]

(b) \_\_\_\_\_ [1]

- 17 The figure below shows an empty container measuring 60 cm by 40 cm by 50 cm. Three identical metal cubes are placed into it. 39 l of water are then poured into the container and the water reaches a height of 35 cm.

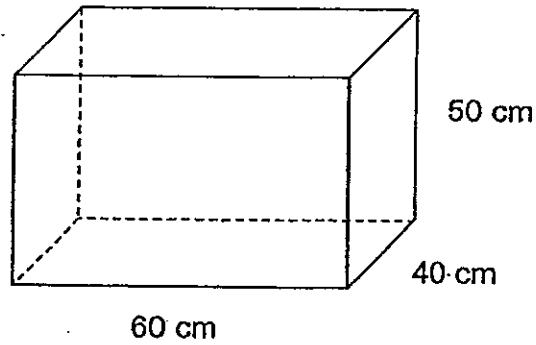

- (a) What is the volume of each metal cube?
- (b) More identical metal cubes are placed into the container and 24 l of water overflowed. How many more metal cubes are placed into the container?

Ans: (a) \_\_\_\_\_ [2]

(b) \_\_\_\_\_ [3]

- 18 Three taps were installed to fill a tank with water. When Tap A and Tap B were turned on at the same time, they took 3 hours to fill half the tank. When Tap B and Tap C were turned on at the same time, they took 12 hours to fill the tank completely. When Tap A and Tap C were turned on at the same time, they took 4 hours to fill the tank completely. How long would it take for the three taps to fill the tank completely when they were all turned on at the same time?

Ans : \_\_\_\_\_ [5]

---

**END OF PAPER**

# ANSWER SHEET

**EXAM PAPER 2013**

**SCHOOL : NANYANG**

**SUBJECT : PRIMARY 5 MATHEMATICS**

**TERM : SA2**

Q1	Q2	Q3	Q4	Q5	Q6	Q7	Q8	Q9	Q10	Q11	Q12	Q13	Q14	Q15
3	4	2	4	1	4	3	4	1	2	3	1	2	4	3

16)  $42 + 8$

17)  $3/8$

18)  $1:2$

19)  $12$

20)  $11$

21)  $200\text{cm}^3$

22)  $40\%$

23)  $180\%$

24)  $\$2400$

25)  $87^\circ$

26)  $2.500\text{kg}$

27)  $\$16$

28)  $15\text{cm}^2$

29)  $46^\circ$

30)  $31$

## Paper 2

1)  $16/15 \times 4 = 44/15$

2)  $\$15 \div 3 = \$5$

$\$5 \times 5 = \$25$

3)  $\$87 \div 100 = \$0.87$

$\$0.87 \times 107 = \$93.09$

4)  $180 - 70 - 70 = 40$

$40 \times 3 = 120$

5)  $126 - 60 = 66$

$180 - 66 = 114$

$114 - 70 = 44^\circ$

6)3:5

7)  $60 \times 30 \times 20 = 36000$

$500 \times 5 = 2500$

$36000 + 2500 = 38500$

$= 38.500L$

8)

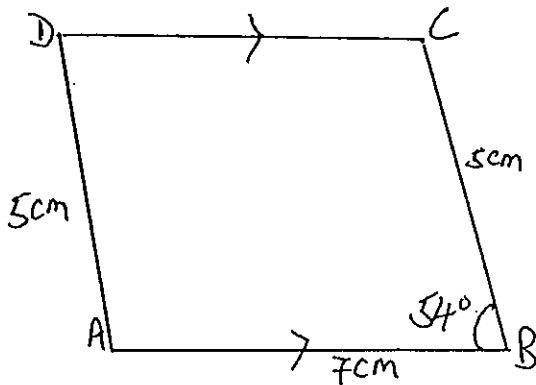

9)  $\$540 \div 2 = \$270$

$\$270 \div 3 = \$90$

$\$90 \times 4 = \$360$

$\$90 \div 2 = \$45$

$\$45 \times 5 = \$225$

10)  $48 - 38 = 10$

$38 - 36 = 2$

$10 \div 2 = 5$

$5 + 1 = 6$

11)a)  $\$980$

b)  $\$42336$

12)a)  $140 \div 7 = 20$

$20 \times 10 = 200$

$200 - 60 = 140$

$140 - 60 = 80$

$80 - 60 = 20$

b)  $2 \times 20 = 40$

$$13) 264 \div 12 = 22$$

$$22 - 16 = 6$$

$$\frac{1}{2} \times 6 \times 22 = 66$$

$$66 - 28 = 38\text{cm}^2$$

$$14) 68 \times 3 = 204$$

$$204 \div 3 = \$68$$

$$68 \times 5 = 340$$

$$340 \div 5 \times \$2 = \$136$$

$$68 \times 2 = 136$$

$$136 \times 0.40 = \$54.40$$

$$\$54.40 + \$68 + \$130 = \$258.40$$

$$15) a) \angle VPS = 180^\circ - 115^\circ = 65^\circ$$

$$\angle QPU = 22^\circ \times 6 = 132^\circ$$

$$\angle QPS = 132^\circ - 65^\circ = 67^\circ = \angle QRS$$

$$\angle PRS = 67^\circ - 22^\circ = 45^\circ$$

$$b) \angle SR = 180^\circ - 67^\circ = 113^\circ$$

$$\angle PST = 180^\circ - 113^\circ = 67^\circ$$

$$\angle PTU = 180^\circ - 67^\circ - 79^\circ = 34^\circ$$

$$16) a) 4 \text{ trays} + 8 \text{ box}$$

$$\rightarrow 60 \times 2 = 120$$

$$\rightarrow \frac{1}{2} + (\frac{1}{2} \times 8 / 12)$$

$$= \frac{1}{2} + \frac{1}{3}$$

$$= \frac{5}{6}$$

$$\frac{1}{6} \rightarrow 120 \div 5 = 24$$

$$\frac{6}{6} \rightarrow 24 \times 6 = 144$$

$$b) 1 \text{ muffin} \rightarrow \$432 \div 144 = \$3$$

$$17) a) 60 \times 40 \times 35 = 84000$$

$$84000 = 84$$

$$84 - 39 = 45$$

$$45 \div 3 = 15L_2$$

$$b) 60 \times 40 \times 15 = 36000$$

$$36000 = 36$$

$$36 + 24 = 60$$

$$60 \div 15 = 4$$

$$18) A+B \rightarrow 1h \rightarrow \frac{1}{6} \text{ tank}$$

$$B+C \rightarrow 1h \rightarrow \frac{1}{12} \text{ tank}$$

$$A+C \rightarrow 1h \rightarrow \frac{1}{4} \text{ tank}$$

$$2A+2B+2C \rightarrow \frac{1}{6} + \frac{1}{12} + \frac{1}{4} = \frac{1}{2}$$

$$A+B+C \rightarrow \frac{1}{2} \div 2 = \frac{1}{4}$$

$$\frac{1}{4} \text{ tank} \rightarrow 1h$$

$$4/4 \text{ tank} \rightarrow 4 \text{ hours}$$

