



NANYANG PRIMARY SCHOOL

SECOND SEMESTRAL EXAMINATION  
2013

PRIMARY 2  
MATHEMATICS

DURATION: 1 HOUR 30 MINUTES

Section A	/ 40
Section B	/ 40
Section C	/ 20

Total:	/ 100
--------	-------

Name: \_\_\_\_\_ (      )

Class: Primary 2 (      )

Date: 29<sup>th</sup> October 2013

Parent's Signature: \_\_\_\_\_

---

DO NOT OPEN THIS BOOKLET UNTIL YOU ARE TOLD TO DO SO.

FOLLOW ALL INSTRUCTIONS CAREFULLY.

ANSWER ALL QUESTIONS.

**Section A**

Questions 1 to 20 carry 2 marks each.

For each question, four options are given.

One of them is the correct answer.

Choose the correct answer and write its number (1, 2, 3 or 4) in the brackets ( ) provided.

(Total: 40 marks)

1. What is the length of the pencil as shown below?

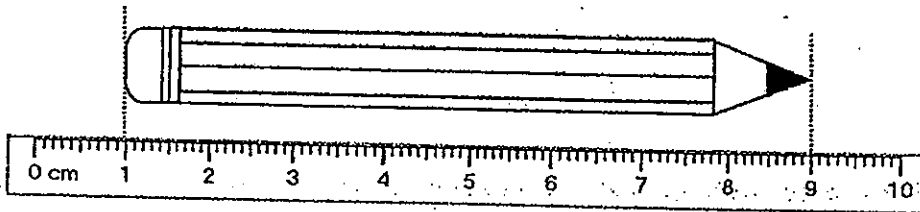

(1) 1 cm

(2) 8 cm

(3) 9 cm

(4) 10 cm

( )

2. 4 groups of 2 is the same as \_\_\_\_\_.

(1)  $2 \times 2 \times 2 \times 2$

(2)  $4 + 2$

(3)  $2 + 2 + 2 + 2$

(4)  $4 \div 2$

( )

3. What is the mass of the toy car as shown below?

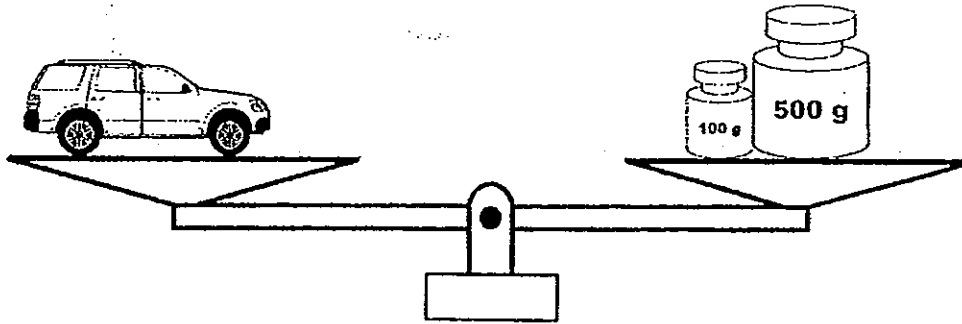

- (1) 100 g                      (2) 500 g  
(3) 510 g                      (4) 600 g                      (           )

4. What is the mass of the bunch of bananas on the weighing scale as shown below?

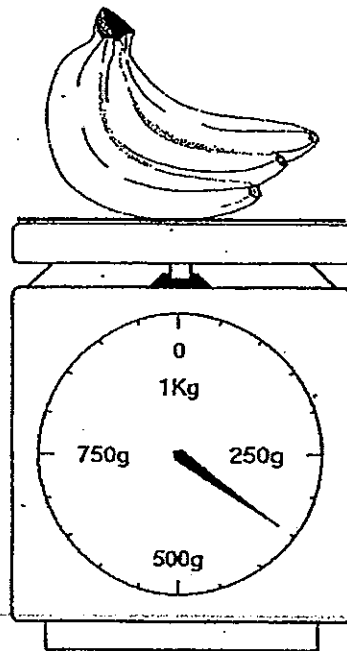

- (1) 270 g                      (2) 290 g  
(3) 350 g                      (4) 450 g                      (           )

5. What is the time shown on the clock face below?

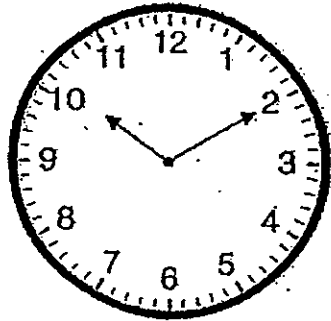

- (1) 10.10 p.m.
- (3) 10.20 p.m.

- (2) 2.10 p.m.
- (4) 2.02 p.m.

( )

6. How many minutes are there from 6 a.m. to 6.30 a.m.?

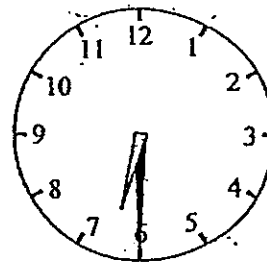
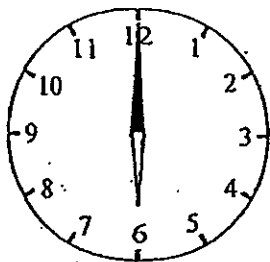

- (1) 60 min
- (3) 30 min

- (2) 35 min
- (4) 6 min

( )

7. How many litres of water are there in the container shown below?

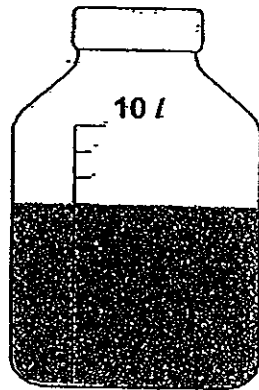

(1) 6 l

(2) 7 l

(3) 8 l

(4) 10 l

( )

8. 2150¢ can be written as \$\_\_\_\_\_.

(1) \$2.15

(2) \$2.50

(3) \$12.50

(4) \$21.50

( )

9. Look at the figure below.

Which one of the figures below shows  $\frac{1}{4}$  ?

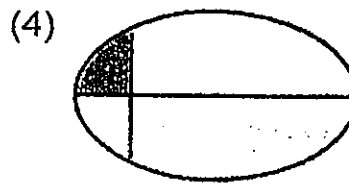
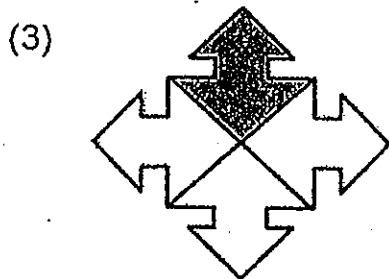
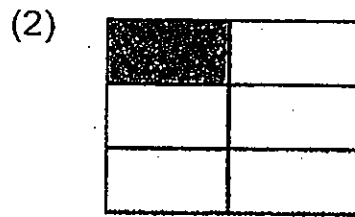
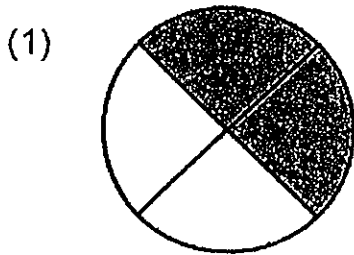

( )

10. Find the sum of  $\frac{3}{5}$  and  $\frac{1}{5}$

(1)  $\frac{5}{4}$

(2)  $\frac{4}{5}$

(3)  $\frac{2}{5}$

(4)  $\frac{4}{10}$

( )

11. Annie is 158 cm tall.  
Celine is 27 cm taller than Annie.  
How tall is Celine?

- (1) 131 cm                      (2) 141 cm  
(3) 175 cm                      (4) 185 cm                      (           )

12. Mrs Ravi had 32 tulips to be put equally into 4 vases. How many tulips should she put in each of the vases?

- (1) 8                                      (2) 9  
(3) 28                                    (4) 36                                    (           )

13. The table below shows the number of pupils and their hobbies.

Types of hobby	Jogging	Chess	Drawing	Reading	Board Games
Number of pupils	4	8	2	10	6

Hobbies of Pupils

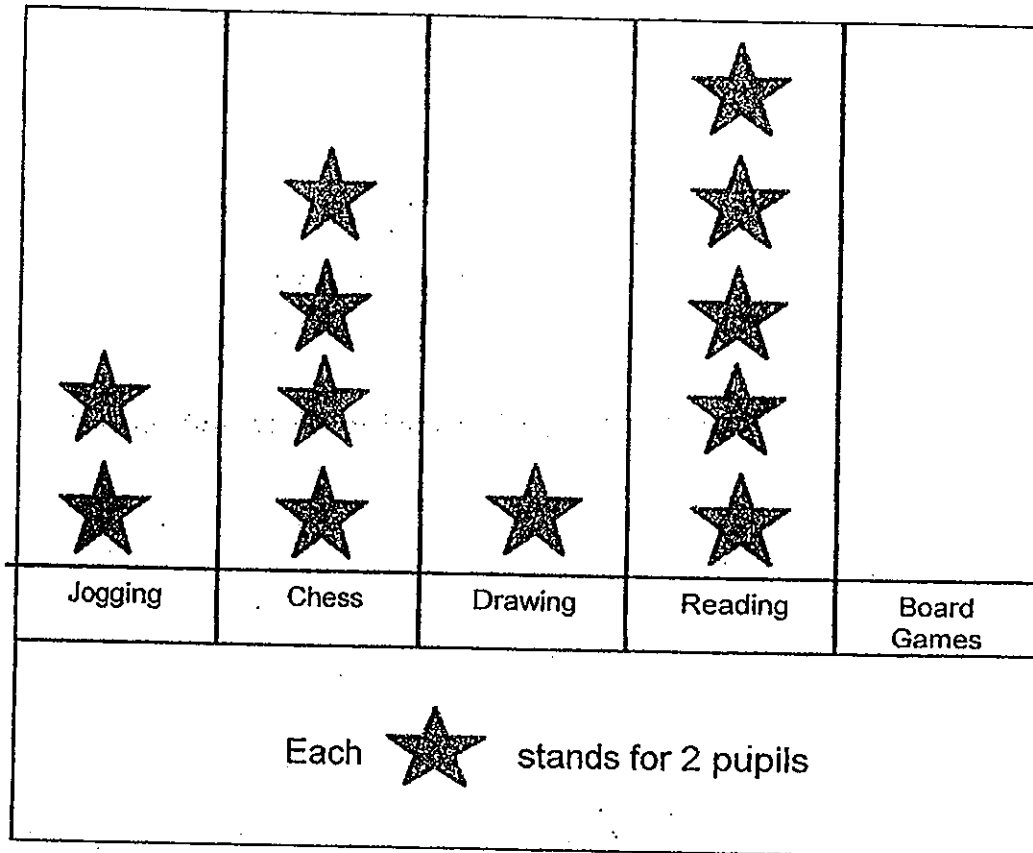

According to the picture graph above, how many ★ should be drawn to show the number of pupils who like to play Board Games?

(1) 1

(2) 2

(3) 3

(4) 4

( )



14. Farm A had 221 chickens.  
Farm B had 363 chickens.  
There were 297 chickens left in the two farms after some chickens were sold.  
How many chickens were sold?

(1) 287 (2) 363  
(3) 660 (4) 881 ( )

15. Jasmine had 4 bundles of 5 pencils.  
She bought 12 more pencils.  
How many pencils did she have in all?

(1) 8 (2) 20  
(3) 21 (4) 32 ( )

16. Joe had 20 red marbles and some blue marbles.  
He packed them into packets of 10 marbles each.  
There were 7 packets of marbles altogether.  
How many blue marbles did Joe have?

(1) 30 (2) 70  
(3) 50 (4) 80 ( )

17. Mrs Smith had 6 boxes of cupcakes.  
There were 10 cupcakes in each box.  
She ate 9 cupcakes and gave away 1 box of the cupcakes.  
How many cupcakes had she left?

(1) 41  
(3) 50

(2) 45  
(4) 51

( )

18. Xiao Ming bought a teddy bear for \$18.  
He gave the cashier five \$10 notes.

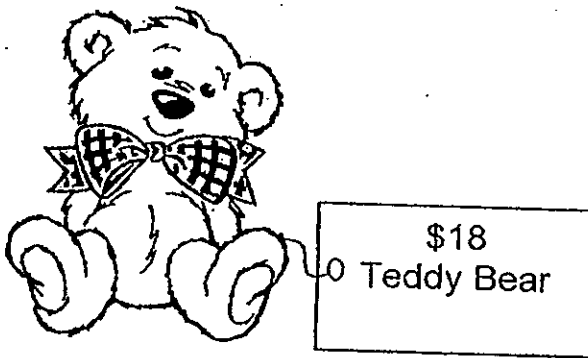

How much change did he receive?

(1) \$18  
(3) \$32

(2) \$28  
(4) \$42

( )

19. Tom was given 3 number cards as shown below.

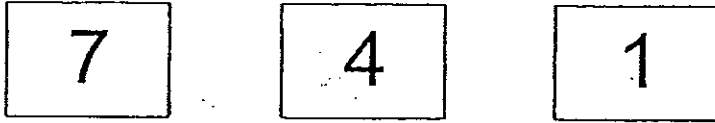

How many different 3-digit odd numbers could he form from the cards?

- (1) 6
- (3) 3

- (2) 2
- (4) 4

(      )

20. Mohammad poured all the paint in the four 3-litre blue paint equally into 3 pails as show below.

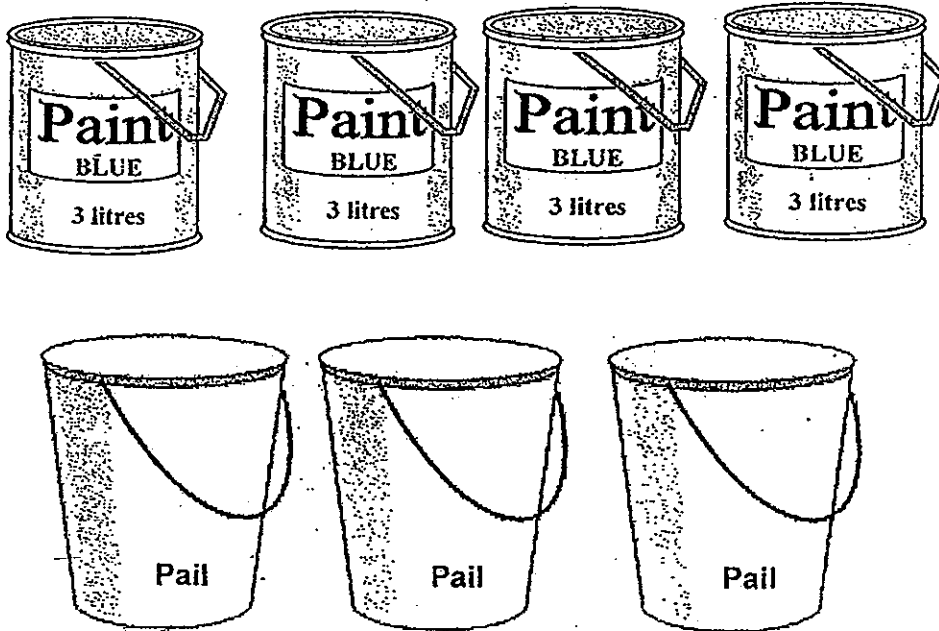

How many litres of paint were there in each pail?

- (1) 12 litres
- (3) 6 litres

- (2) 9 litres
- (4) 4 litres

(      )

**Section B**

Questions 21 to 40 carry 2 marks each.  
Write your answers in the spaces provided.  
Give your answer in the units stated.

(Total: 40 marks)

21. a) Write 80 tens and 47 ones in numerals.

Answer : \_\_\_\_\_

- b) Write three hundred and five in numerals.

Answer : \_\_\_\_\_

22. Arrange these numbers in order.  
Begin with the smallest.

**265, 295, 259**

\_\_\_\_\_

23. Complete the math equation below

$$45 \div 5 = \underline{\quad ? \quad}$$

Answer : \_\_\_\_\_

24. Write the amount of money shown below.



Answer : \$ \_\_\_\_\_

25. The figure below is a square.  
What fraction of the figure below is shaded?

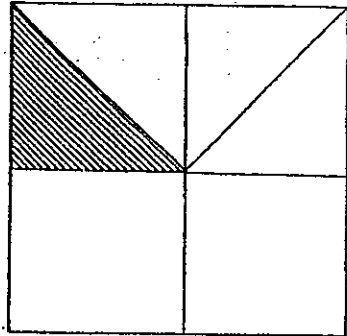

Answer : \_\_\_\_\_

26. Arrange the following fractions in order beginning with the greatest.

$$\frac{5}{9}, \frac{1}{9}, \frac{9}{9}$$

Answer : \_\_\_\_\_

27. Use the numbers below to fill in the boxes.  
Use each number only once.

**193, 785, 655**

$$419 + 236 = \boxed{\phantom{000}}$$

$$\boxed{\phantom{000}} - \boxed{\phantom{000}} = 592$$

28. A basin and a pail contain 65 l of water altogether.  
The basin contains 42 l of water.  
How much water does the pail contain?

Answer : \_\_\_\_\_ l

29. Jane had 10 stamps.  
Pete had twice as many stamps as Jane.  
How many stamps did they have altogether?

Answer : \_\_\_\_\_

30. Joanne baked a cake.  
She gave  $\frac{3}{8}$  of it to Jerry and  $\frac{2}{8}$  of it to Carrie.  
What fraction of the cake had she left?

Answer : \_\_\_\_\_

31. The remedial class ended at the time shown below.  
The time as shown below was 1 hour slower than the actual time.  
What time did the remedial class end?

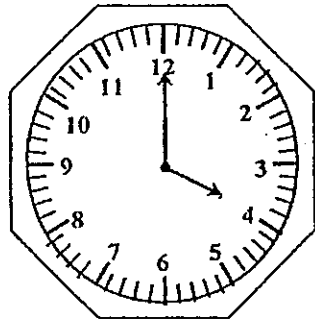

Answer : \_\_\_\_\_ p.m.

32. Tim went to a cinema at the time shown on the clock below.

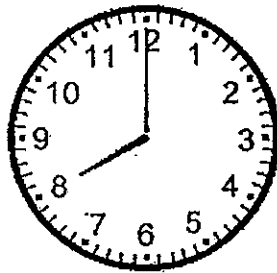

He had his dinner 30 minutes before he went to the cinema.  
What time did he have his dinner?

Answer : \_\_\_\_\_ p.m.



33. Study the figures below.  
What are the missing numbers A and B?

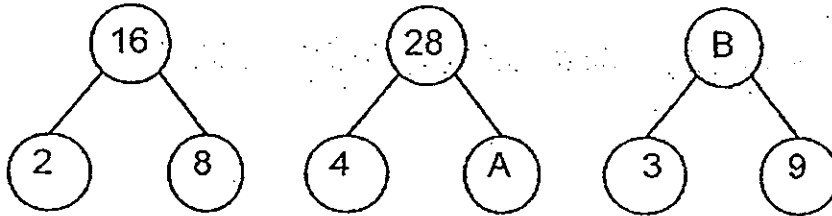

Answer : A: \_\_\_\_\_

B: \_\_\_\_\_

34. At a party, there were 6 girls and 4 boys.  
Each child was given 4 balloons.  
How many balloons were given out altogether?

Answer : \_\_\_\_\_

35. Serene had 45 oranges.  
She threw 9 rotten oranges away.  
She gave the rest of the oranges to her friends.  
Each friend received 4 oranges.  
How many friends did Serene give her oranges to?

Answer : \_\_\_\_\_

36. Some trees are equally spaced out along a road.  
The distance between the 1st and 2nd tree is 8 m.  
What is the distance between the 1st and the 6<sup>th</sup> tree?

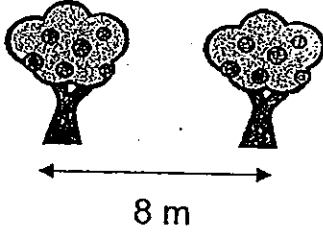

Answer : \_\_\_\_\_ m

37. Study the diagram below.  
What is the mass of two such apples?

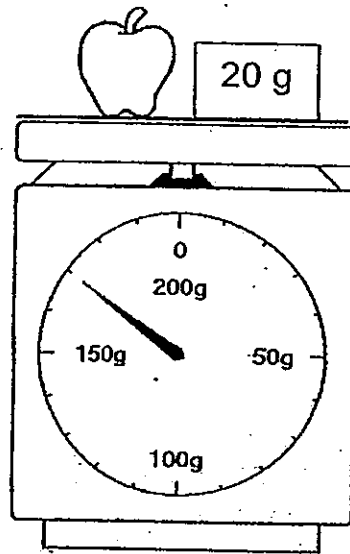

Answer : \_\_\_\_\_ g

38. Uncle David gave Leonard \$18.  
Leonard saved \$5 every day for one week.  
How much money did he have in all after one week?

Answer : \$ \_\_\_\_\_

39. A concert hall has 24 seats in Row 1.  
It has 25 seats in Row 2.  
There are 26 seats in Row 3 and 27 seats in Row 4.  
Which two rows can seat 52 people?

Answer : Row \_\_\_\_\_ and Row \_\_\_\_\_

40. Pamela is older than Felicia but younger than Janelle.  
Janelle is younger than Henry.  
Who is the oldest?

Answer : \_\_\_\_\_

**Section C**

Questions 41 to 45 carry 4 marks each.

Do these word problems carefully.

Show your working clearly in the space provided for each question.

(Total: 20 marks)

41. Kayla reads 3 pages of a book each day.  
She completes reading the book after 8 days.  
How many pages are there in the book altogether?

There are \_\_\_\_\_ pages in the book altogether.

42. Box A is 572 g.  
Box B is 148 g less than Box A.  
Box C is 396 g more than Box B.  
What is the mass of Box C?

The mass of Box C is \_\_\_\_\_ g.

43. There were 216 boys and 153 girls at a party at first.  
After an hour, 37 children joined the party.  
How many children were there at the party after an hour?

\_\_\_\_\_ children were at the party after an hour.

44. Jonathan has three times as much money as Veronica.  
Veronica has \$9.  
Rachel has \$48 more than Jonathan.  
How much money does Rachel have?

Rachel has \$\_\_\_\_\_

45. The table below shows the number of pupils who joined the Swimming Club in each class.

Class	3A	3B	3C	3D
Number of pupils	6	?	12	3

- (a) The number of pupils who joined the Swimming Club in Class 3A is two times as many as class 3B.  
How many pupils joined the Swimming Club in Class 3B?

\_\_\_\_\_ pupils joined the Swimming Club in class 3B.

- (b) Using the information above, complete the picture graph as shown below.

**Pupils who joined the Swimming Club**

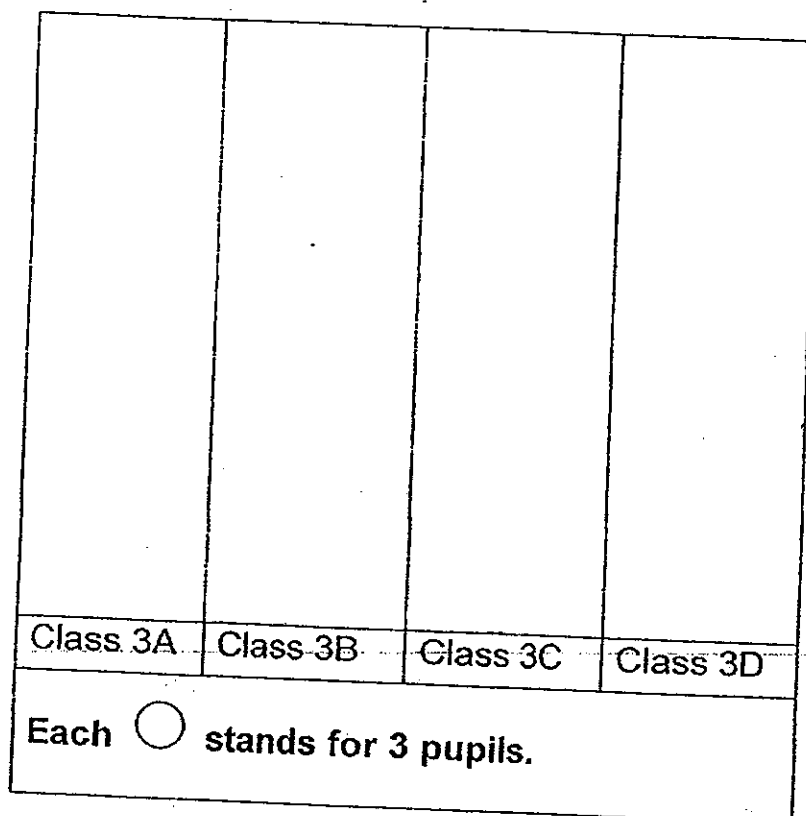

☺ End of Paper ☺  
Please Check Carefully

# ANSWER SHEET

EXAM PAPER 2013

SCHOOL : NANYANG PRIMARY SCHOOL

SUBJECT : PRIMARY 2 MATHEMATICS

TERM : SA2

---

Q1	Q2	Q3	Q4	Q5	Q6	Q7	Q8	Q9	Q10	Q11	Q12	Q13	Q14	Q15	Q16	Q17
2	3	4	3	1	3	2	4	3	2	4	1	3	1	4	3	1

Q18	Q19	Q20
3	4	4

Section B

Q21) a) 847

b) 305

Q22) 259, 265, 295

Q23) 9

Q24) \$31.45

Q25)  $\frac{1}{8}$

Q26)  $\frac{9}{9}$ ,  $\frac{5}{9}$ ,  $\frac{1}{9}$

Q27)  $419 + 236 = 655$

$785 - 193 = 592$

Q28) 23L

Q29) 30

Q30)  $\frac{3}{8}$

Q31) 5:00pm

Q32) 7:30pm

Q33) A: 7

B: 27

Q34) 40

Q35) 9

Q36) 40m

Q37) 300g

Q38) \$53

Q39) Row 2 and 4

Q40) Henry

Section C

Q41)  $8 \times 3 = 24$

Q42)  $572\text{g} - 148\text{g} = 424\text{g}$

$396\text{g} + 424\text{g} = 820\text{g}$

Q43)  $216 + 153 = 369$





$369 + 37 = 406$

Q44)  $\$9 \times 3 = \$27$

$\$27 + \$48 = \$75$

Q45) a)  $6 \div 2 = 3$  pupils

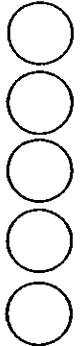
b)

			
Class 3A	Class 3B	Class 3C	Class 3D