



2023 PRIMARY 6 PRELIMINARY EXAMINATION

Name: _____

Date: 23 August 2023

Class : Primary 6

Time: 8.00 a.m. - 9.45 a.m.

Duration: 1 hour 45 minutes

SCIENCE BOOKLET A

INSTRUCTIONS TO CANDIDATES

1. Write your name, class and register number.
2. Do not turn over this page until you are told to do so.
3. Follow all instructions carefully.
4. Answer all questions.
5. Shade your answers on the Optical Answer Sheet (OAS) provided.

Booklet A (28 x 2 marks)

For each question from 1 to 28, four options are given. One of them is the correct answer. Make your choice (1, 2, 3 or 4) and shade your answer on the Optical Answer Sheet.

(56 marks)

1. Amphibians breathe through _____.

- (1) lungs in water
- (2) moist skin on land
- (3) moist skin and lungs in water
- (4) moist skin in water and lungs on land

2. Which of the following is correct for both the mosquito and the moth?

- (1) Both lay eggs in water.
- (2) Both have a four-staged life cycle.
- (3) Both their young and adult live on land.
- (4) Both have young that look like the adults.

3. The diagrams show two cells.



A



B

Which statement is correct?

- (1) B is a plant cell because it has cell wall.
- (2) A is a plant cell because it has a nucleus.
- (3) A and B are animal cells because they do not have chloroplasts.
- (4) A and B are plant cells because they have nucleus and cell membrane.

4. Study the food web below.

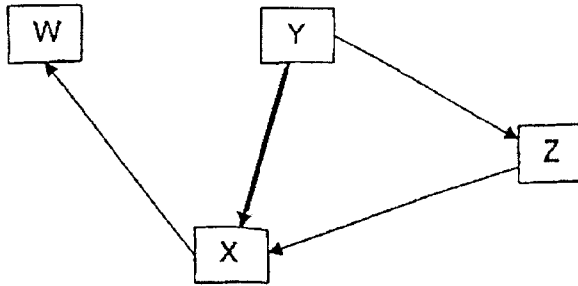

A large number of organism H was introduced into the habitat. H only fed on one type of organism in this habitat. After some time, only organisms Y and Z increased in number.

Which of the following shows the correct relationship between H and the other organisms?

- (1) Y is a prey of H.
 - (2) X is a prey of H.
 - (3) H is a predator of Z.
 - (4) H is a predator of W.
5. Study the diagrams below.



P



Q



R



S

In which of the plants has pollination definitely taken place?

- (1) P and S only
- (2) P and Q only
- (3) R, Q and S only
- (4) P, Q and S only

6. The flowchart below shows the gases in the exhaled air of a human.

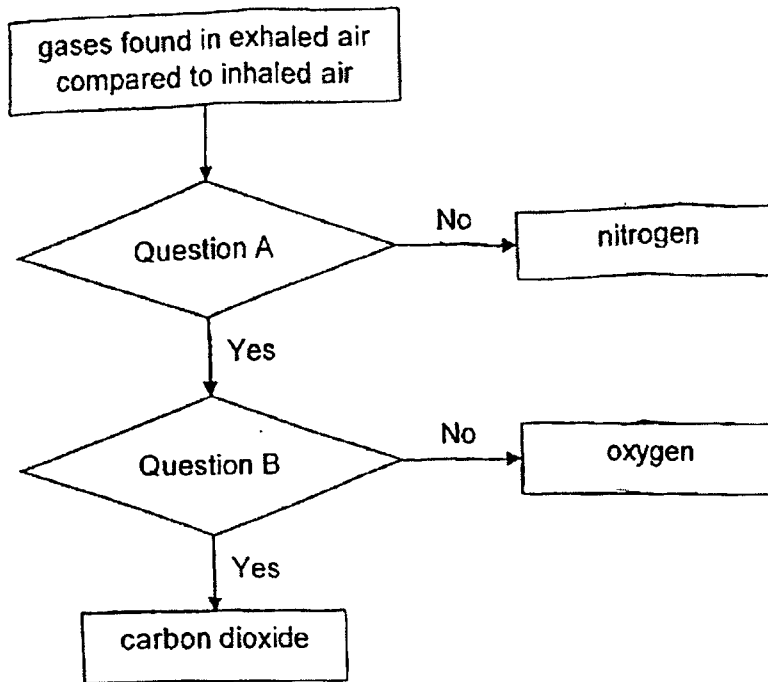

Which of the following is correct?

	Question A	Question B
(1)	Does the amount of gas change?	Does the amount of gas decrease?
(2)	Does the amount of gas change?	Does the amount of gas increase?
(3)	Does the amount of gas decrease?	Do the lungs take in this gas?
(4)	Does the amount of gas increase?	Do the lungs take in this gas?

7. What would least likely happen after large areas of forests are cleared?

- (1) more soil would be eroded
- (2) more rainfall in that area
- (3) fewer habitats for animals
- (4) more carbon dioxide in the air

8. A germinating seed is shown below.

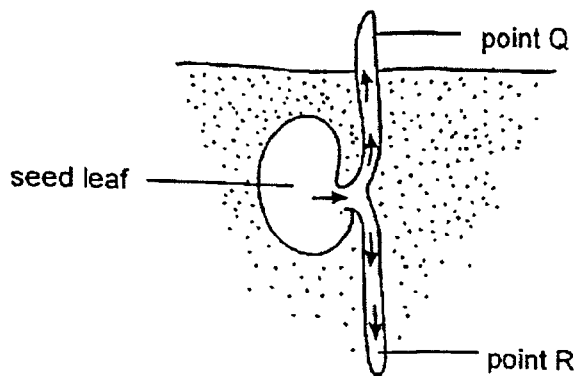

What do the arrows show?

- (1) Food is transported to R only.
- (2) Food is transported to Q and R.
- (3) Water is transported to Q and R.
- (4) Water is transported to R and food is transported to Q.

9. The diagram below shows the transport of substances in the human circulatory system. Z is an organ and Q is a blood vessel.

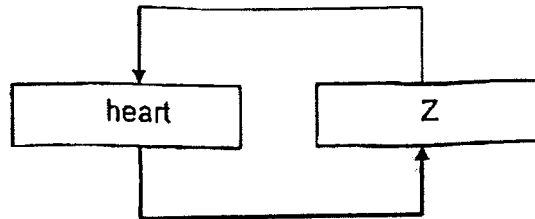

What could Z and the type of blood found in Q be?

	Z	Type of blood
(1)	stomach	poor in oxygen
(2)	stomach	rich in oxygen
(3)	lung	poor in oxygen
(4)	small intestine	rich in oxygen

10. The diagram below shows the human digestive system.

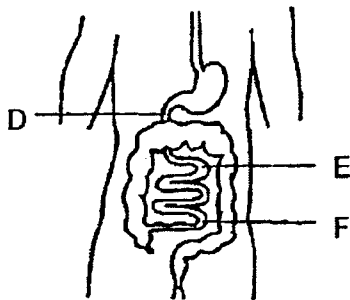

Which of the following is true?

- (1) There is only digested food in D.
- (2) There is no undigested food in F.
- (3) There is more digested food in E than D.
- (4) There is more undigested food in F than D.

11. Emily conducted an experiment by dropping a seed from a height and measured the distance, D , travelled by the seed.

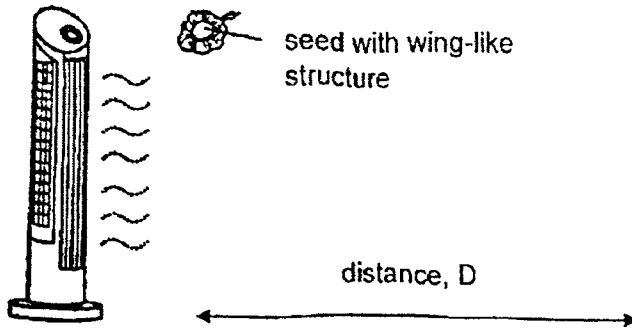

Which of the following graphs could most likely be the results recorded by Emily?

(1) distance, D

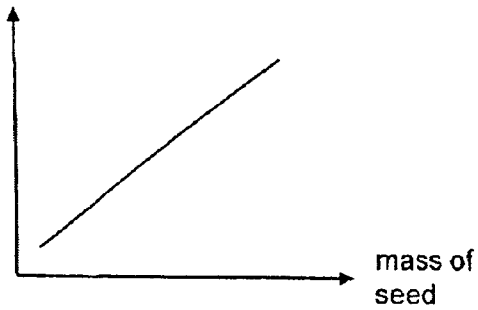

(2) distance, D

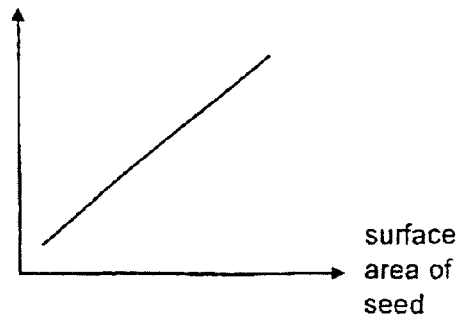

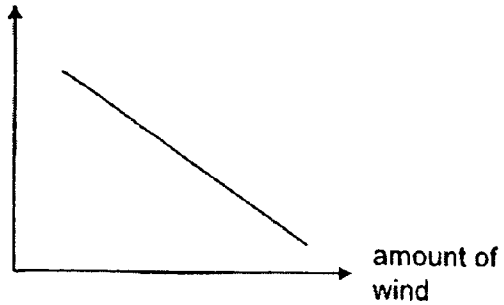

(3) distance, D

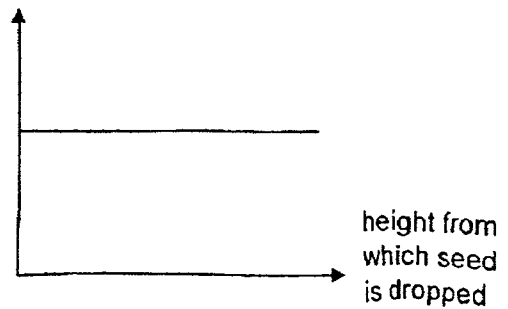

(4) distance, D



12. The table below shows the temperature of two leaves of a plant found in a desert in a flat position and a vertical position. The average temperature of the desert is 38°C between May and July.

		
Position of leaf	flat	vertical
Temperature of leaf ($^{\circ}\text{C}$)	30	28

The picture below shows how this desert plant tilts its leaves vertically upwards at noon.

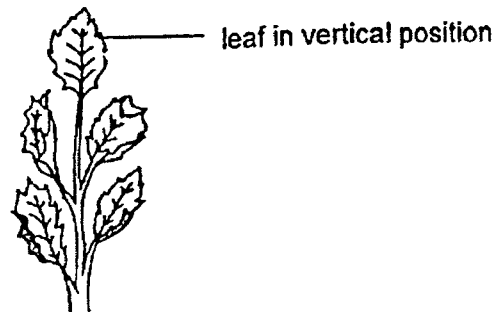

Based on the information above, which of the following explains how the behavioural adaptation of this plant helps in its survival?

- (1) The leaves lose more heat.
- (2) The leaves lose less water.
- ~~(3)~~ The leaves make more food.
- ~~(4)~~ The leaves provide more shade for itself.

13. Waste from animals was released into the river at point X. After some time, the number of fish decreased sharply in the river at point Y.

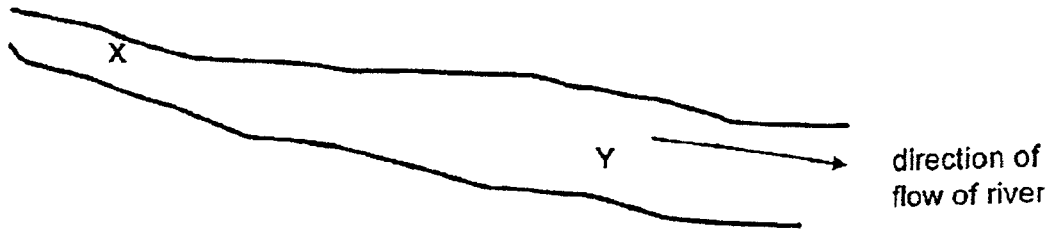

Which of the following could be the cause of the decrease in the number of fish at point Y?

- (1) The number of floating plants decreased.
- (2) The amount of dissolved oxygen increased.
- (3) The amount of bacteria in the water increased.
- (4) The amount of nutrients in the water decreased.

14. Three leaves were wrapped up using three different types of plastic bags of the same size. The pot of plant was left under bright sunlight for some time.

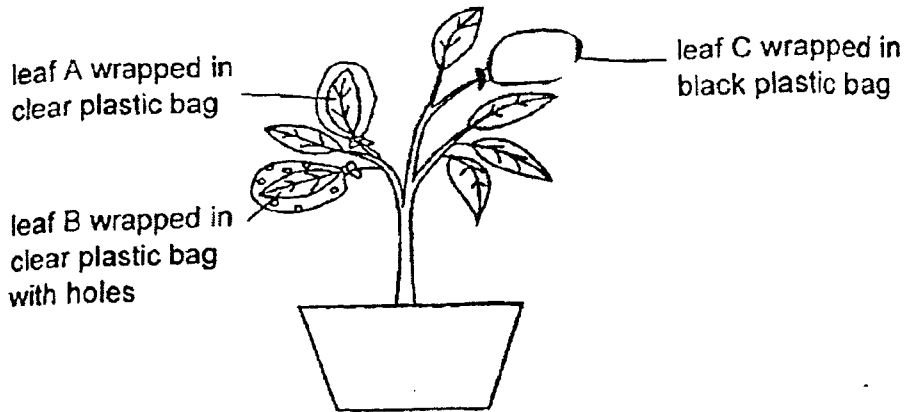

Which graph most correctly represents the amount of food the leaves made after a few hours?

(1) amount of food made

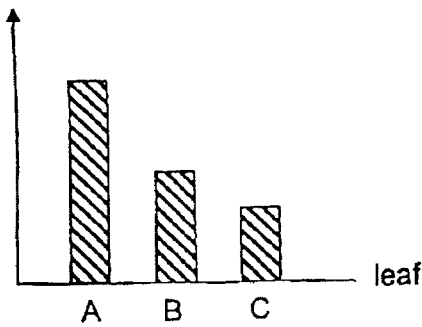

(2) amount of food made

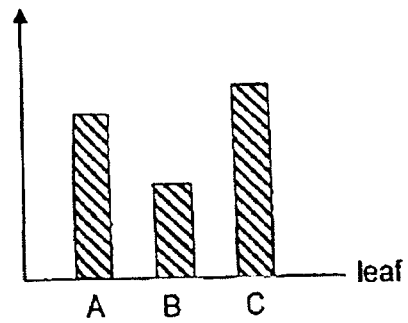

(3) amount of food made

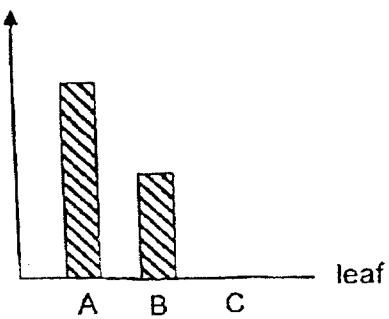

(4) amount of food made

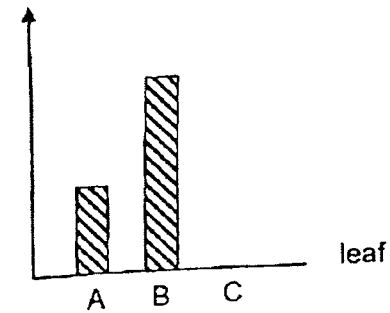

15. A block was pushed down the ramp from point A as shown in diagram 1 and it stopped moving at point B as shown in diagram 2.

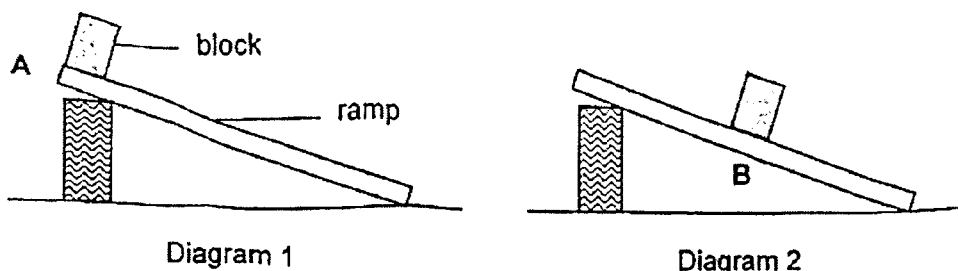

Which of the following is correct?

- (1) Gravity decreases as the block moved from A to B.
 - (2) There is more friction acting on the block at B than at A.
 - (3) Gravity stopped acting on the block when it stopped moving.
 - (4) Friction and gravity acted on the block as it moved from A to B.
16. Two identical containers, P and Q, with capacity of 300 cm^3 were placed on the lever balance as shown below.

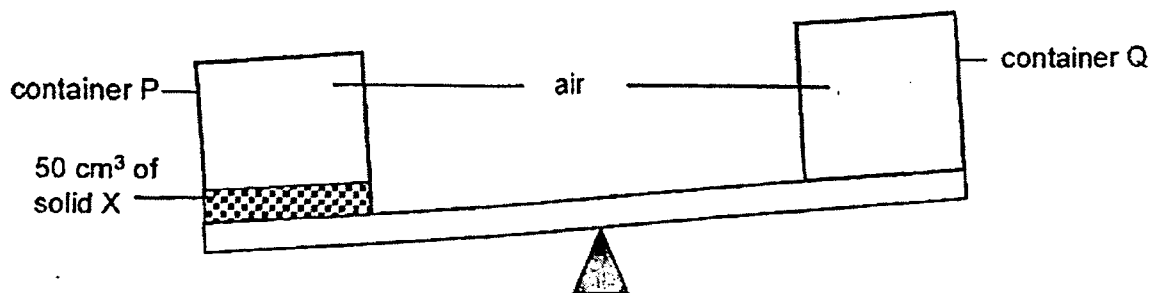

What can you conclude from the diagram above?

- (1) Air has mass.
- (2) Air can be compressed.
- (3) The volume of air in both containers is not the same.
- (4) Air in container P has more mass than air in container Q.

17. Yiming was playing with a toy yoyo as shown below. It moved from point X to point Y, then back to point X.

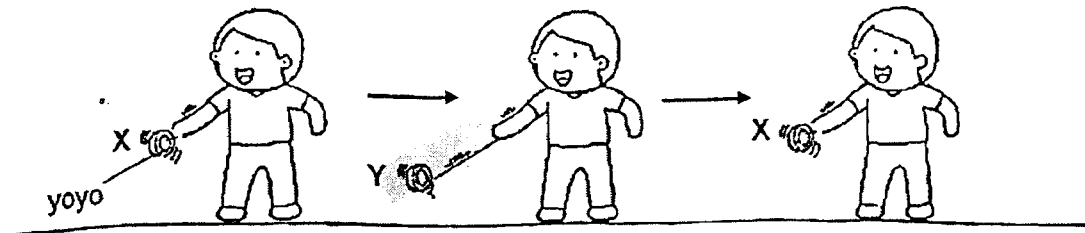

Which of the following correctly shows the change in the amount of energy of the yoyo?

	Potential energy of the Yoyo from X to Y	Kinetic energy of the Yoyo from Y to X
(1)	decreases	increases
(2)	decreases	decreases
(3)	increases	decreases
(4)	increases	increases

18. The table shows the melting and boiling points of three substances, R, S and T.

Substance	melting point (°C)	boiling point (°C)
R	114	184
S	44	280
T	52	300

Which of the following can be concluded from the information in the table?

- (1) R and T are solids at 10°C.
- (2) R and S are gases at 60°C.
- (3) S and T are liquids at 30°C.
- (4) S and T are gases at 285°C.

19. The diagram shows how a ball rolls from point A to D along the cement surface.

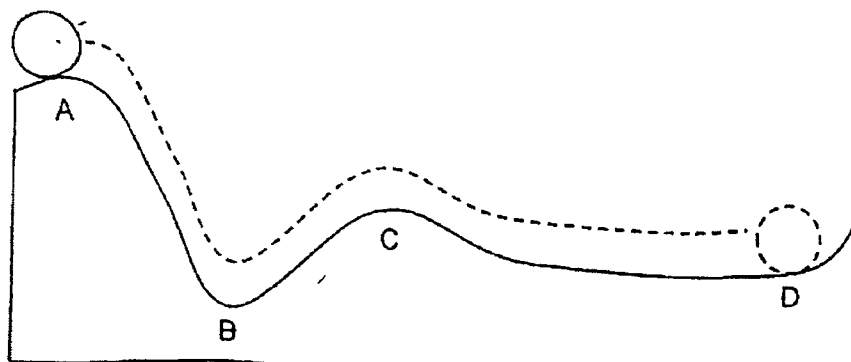

Which statement about the ball is correct as it rolls from point A to point D?

- (1) The ball does not have kinetic energy at B.
 - (2) Kinetic energy of the ball at B is greater than at D.
 - (3) Kinetic energy of the ball increases as it rolls from B to C.
 - (4) Potential energy of the ball at A is the same amount as the kinetic energy of the ball at B.
20. Siti placed her wet finger on an ice cube inside a freezer. She observed that her finger was stuck to the surface of the ice cube after some time.

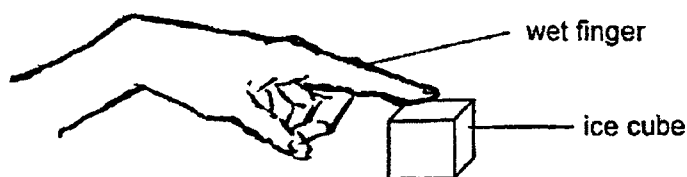

Which of the following best explains Siti's observation?

- (1) Water on Siti's finger lost heat to her finger and froze.
- (2) Water on Siti's finger gained coldness from the freezer and froze.
- (3) The ice cube gained heat from Siti's finger and melted.
- (4) Water on Siti's finger lost heat to the ice and froze.

21. Sujesh has three sheets of same material with different shapes cut out in the middle.

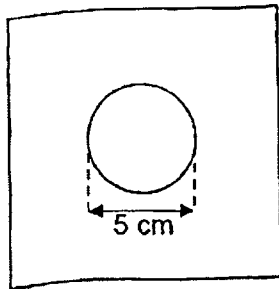

sheet X

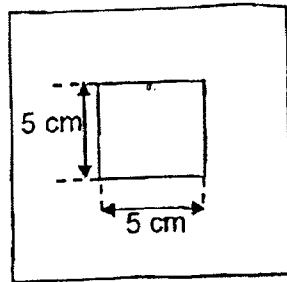

sheet Y

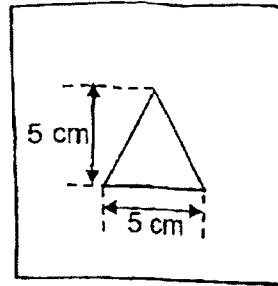

sheet Z

She conducted the experiment in a dark room using the setup below.

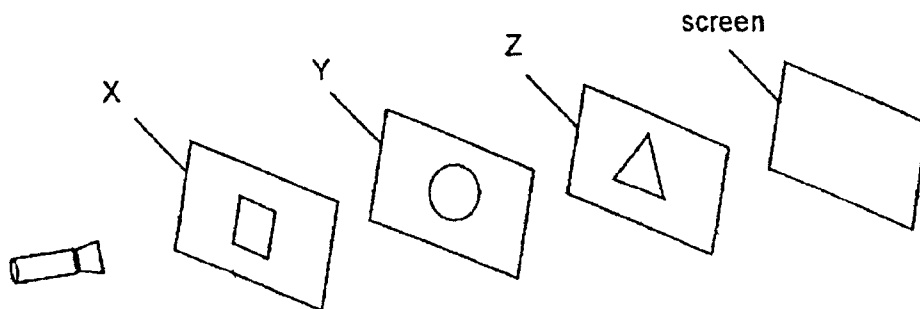

Which of the following will be formed on the screen?

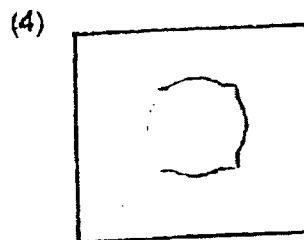
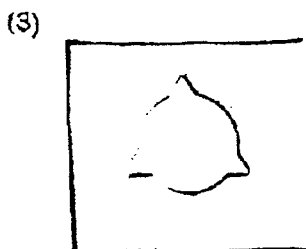
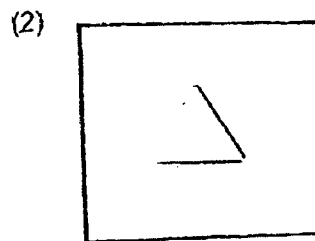
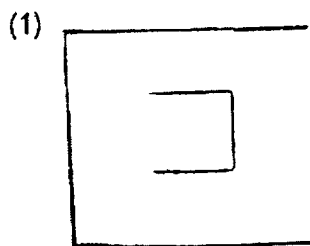

22. Rachel wanted to find out how the exposed surface area of water affects the rate of evaporation of water.

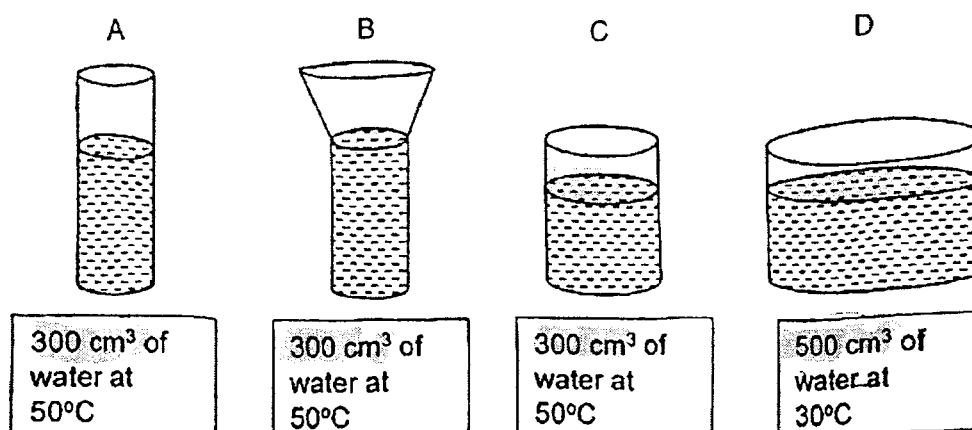

Which two set-ups should she use in her experiment?

- (1) A and B
 - (2) A and D
 - (3) B and C
 - (4) C and D
23. Identical bulbs, A, B, C and D, are used in the circuit.

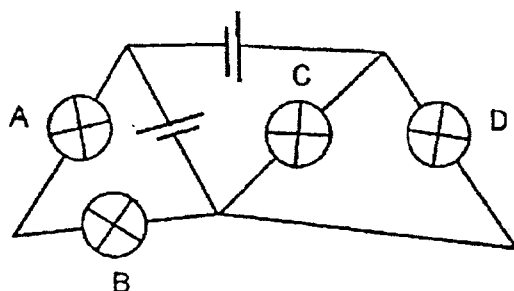

Which change will allow D to be the brightest bulb in the circuit?

- (1) increase the number of batteries
- (2) add an identical bulb in series with C
- (3) add an identical bulb in parallel with D
- (4) add an identical bulb in series with A and B

24. A system was set up to make use of a light bulb R and an alarm S to alert the user when the fridge door is not closed fully and temperature rises in the fridge. As temperature rises, switch 1 will close, followed by switch 2.

The table shows the observations at different temperatures.

Temperature of the fridge (°C)	Light bulb R	Alarm S
4	off	off
6	off	on
7	on	on

Which of the following is the set-up of the system described above?

(1)

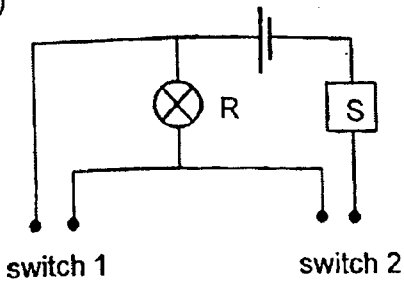

(2)

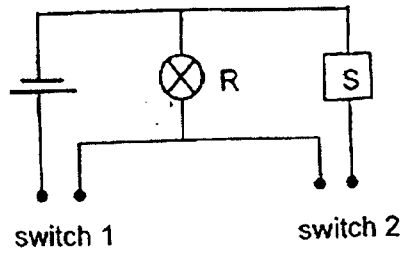

(3)

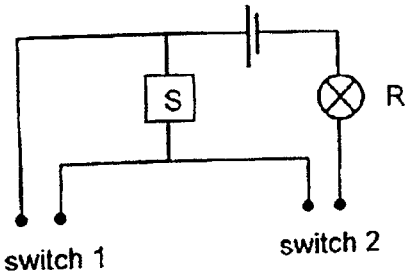

(4)

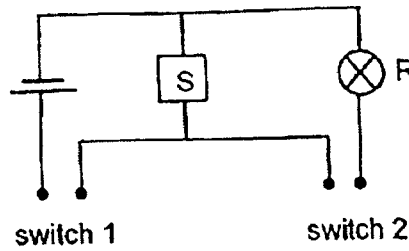

25. Three springs, X, Y and Z, have the same length. When the three springs are compressed using three identical blocks, the results are as shown.

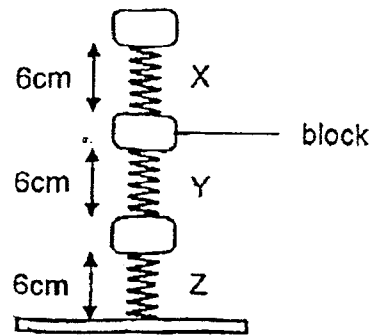

Which of the following can be concluded from the results?

- (1) X is the stiffest.
 - (2) Y is stiffer than X.
 - (3) Y is stiffer than Z.
 - (4) X, Y and Z are of the same stiffness.
26. Angie set up an experiment as shown in the diagram below. The opening of the glass box was covered with material X.

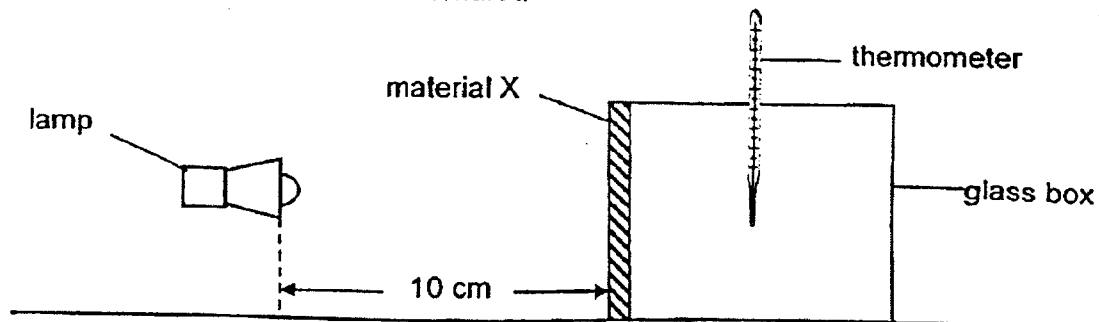

Angie recorded the time taken for the temperature of the air inside the box to increase by 2°C after the lamp was switched on. She repeated her experiment with materials Y and Z.

Which of the following had to be kept constant for the experiment to be a fair test?

- (1) the duration the lamp was shone at each material
- (2) the amount of light that passed through each material
- (3) the rate at which heat was conducted through each material
- (4) the temperature of each material at the start of the experiment

27. Diagram 1 shows a glass container filled with tea placed above a glass cup. When the handle of the cup is pushed towards the metal ball, the metal ball moved towards P and tea flowed into the cup as shown in Diagram 2.

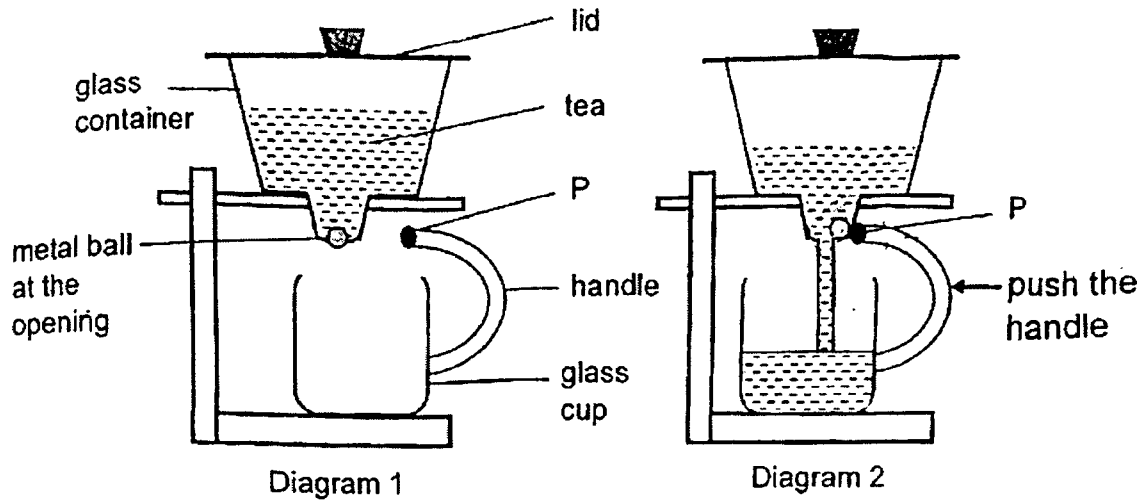

Which of the following is correct?

- (1) Gravitational force was acting on the tea in Diagram 2 only.
- (2) Gravitational force pulled the metal ball towards P in Diagram 2.
- (3) Magnetic force pushed the tea out of the glass container in Diagram 2.
- (4) Magnetic force pulled the metal ball to unblock the opening in Diagram 2.

28. Two rods, A and B, are arranged as shown in the diagram. One of them is a magnet and the other is made of magnetic material.

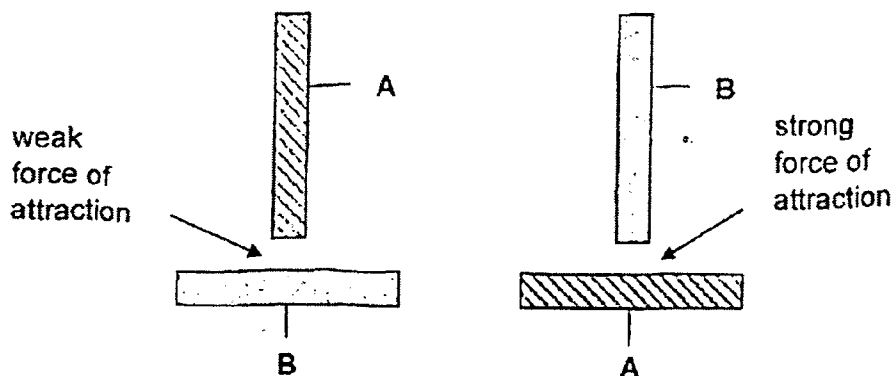

Which of the following is possible if magnet Q is placed near A and B?

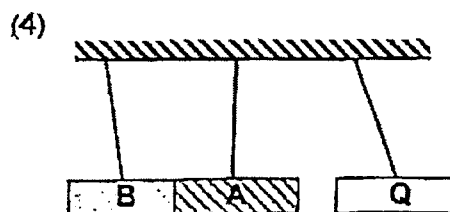
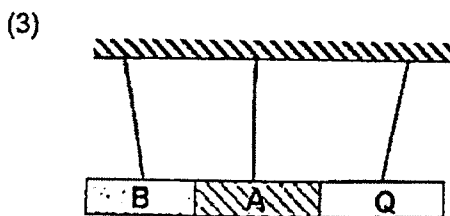
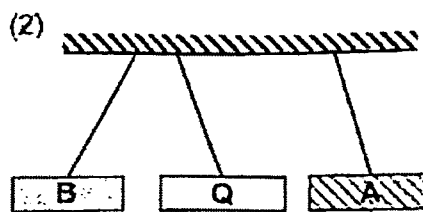
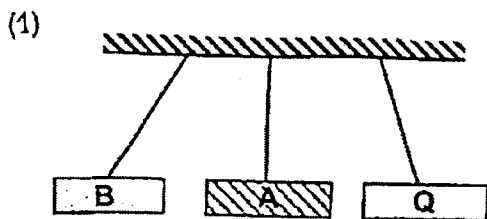

End of Booklet A



2023 PRIMARY 6 PRELIMINARY EXAMINATION

Name: _____ (25)

Date: 23 August 2023

Class : Primary

Time: 8.00 a.m. – 9.45 a.m.

Parent's Signatur. . _____

Duration: 1 hour 45 minutes

SCIENCE

BOOKLET B

INSTRUCTIONS TO CANDIDATES

1. Write your name, class and register number.
2. Do not turn over this page until you are told to do so.
3. Follow all instructions carefully.
4. Answer all questions.
5. Use a dark blue or black ballpoint pen to write your answers in the space provided for each question.
6. Do not use correction fluid/tape or highlighters.

Booklet A	56
Booklet B	44
Total	100

Booklet B (44 marks)

For questions 29 to 41, write your answers clearly in this booklet.

The number of marks available is shown in brackets [] at the end of each question or part question.

(44 marks)

29. Study the flowchart below. A, B, C and D are living things.

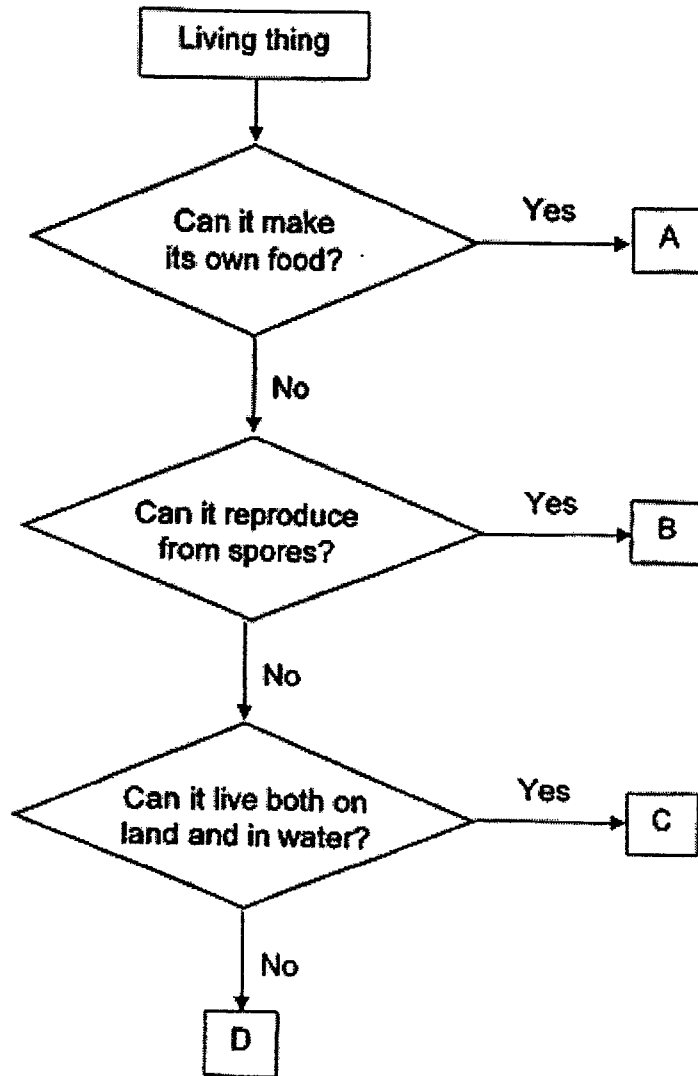

(a) Based on the flowchart above, which letter best represents a mushroom?
Explain your answer. [1]

Score	1
-------	---

(b) Based on the flowchart above, state one similarity between B and C. [1]

Sarah is presented with organism P as shown below.

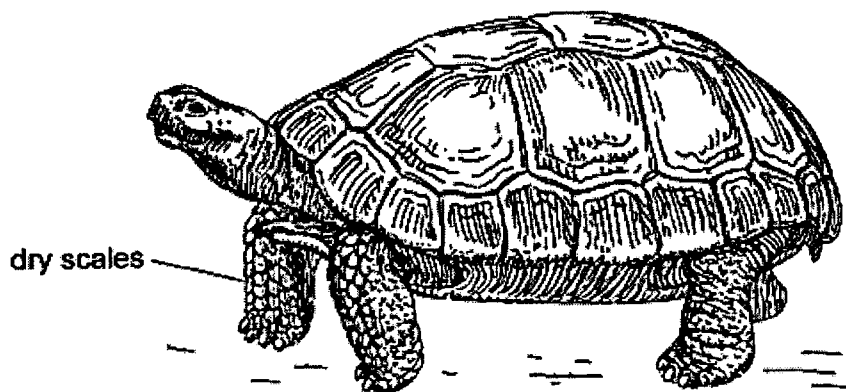

(c) Based on the unique characteristic of organism P as observed above, explain why this organism cannot be grouped under C. [1]

Score	2
-------	---

30. The diagram below shows 2 set-ups, A and B. The plants in both set-ups are identical.

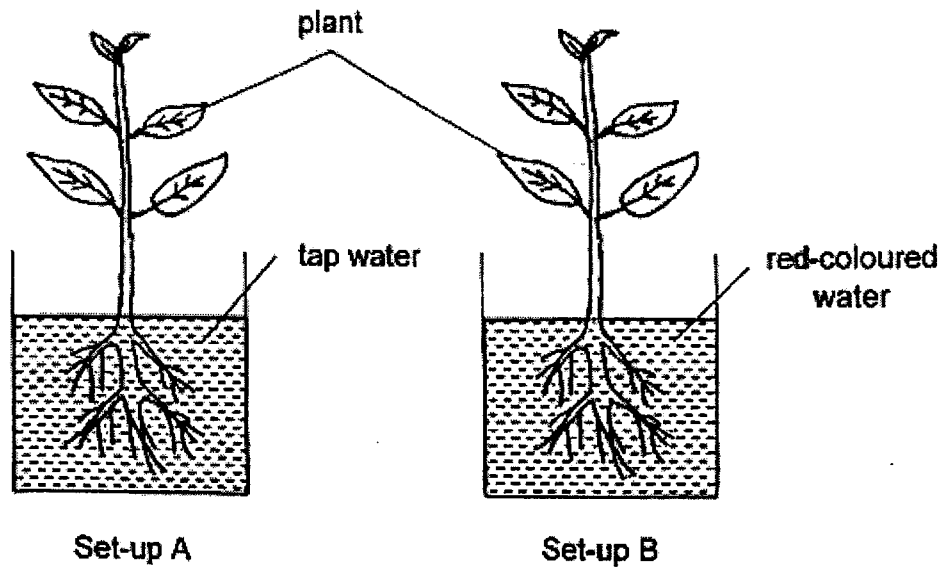

- (a) What change would be observed about the plant in set-up B after 1 day?
Explain your answer. [1]

- (b) What is the purpose of set-up A? [1]

31. The diagram below shows a flower.

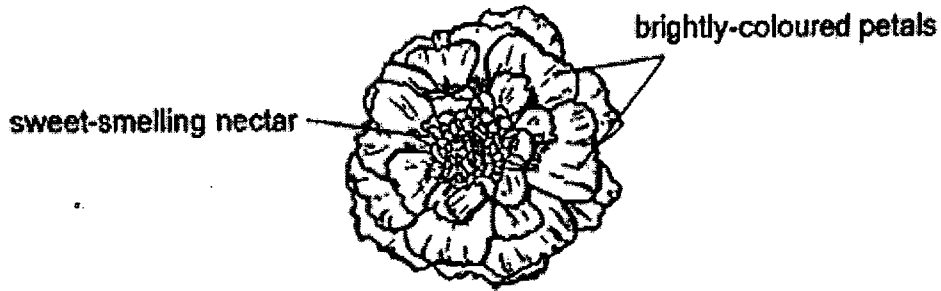

(a) Describe how the characteristics of the flower helps the plant in reproduction. [1]

The diagram below shows two plants, Y and Z. The roots of plant Y grow into the branches of plant Z. When the fruit of plant Y is ripe, it shoots out a seed that can travel up to 20 metres.

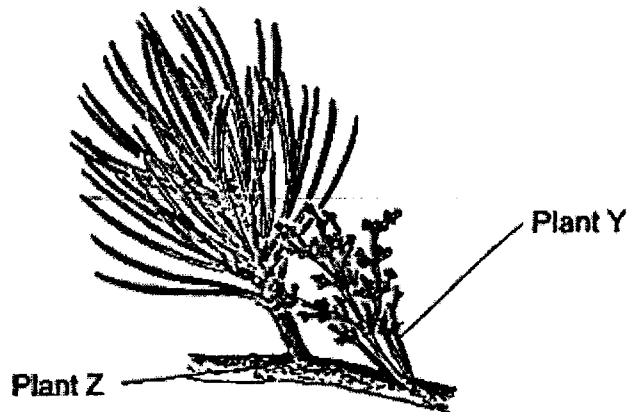

(b) The seeds of plant Y are coated with a sticky substance. Explain how this benefits plant Y in its survival. [1]

(c) Explain why it is a disadvantage for plant Z to have plant Y growing on its branches. [1]

Score	3
-------	---

32. Hasan set up an experiment as shown below. He left the set-up outdoors from 10 am to 10 pm.

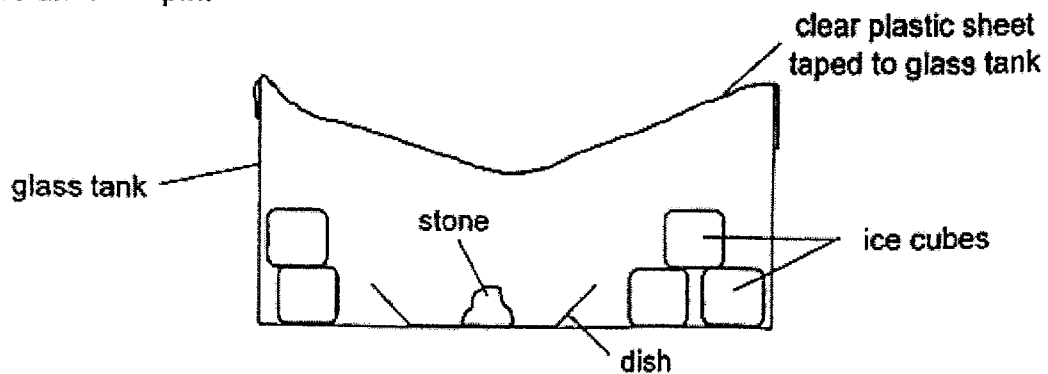

- (a) Water droplets were seen on the underside of the clear plastic sheet at 10 pm. Explain how the water droplets were formed. [2]

- (b) Without adding any items into the glass tank, what could Hasan do to increase the amount of water droplets formed on the underside of the clear plastic sheet? [1]

After 12 hours, Hasan collected the water in the dish as shown below. The capacity of the dish is 50 ml.



- (c) Describe how Hasan can find the volume of the stone. [2]

33. Ming Qian and his brother were trapped in a faulty lift for 30 minutes. Air could not enter or leave the lift.

(a) State if the amount of oxygen and carbon dioxide in the lift increases, decreases or remains the same after 30 minutes. [1]

Oxygen: _____

Carbon dioxide: _____

(b) Explain your answer in (a). [1]

Ming Qian and his brother started jumping and waving their arms to attract the attention of the people outside the lift. After a while, they felt faint.

(c) Using the circulatory and respiratory systems, explain how their actions caused them to feel faint. [2]

Score	4
-------	---

34. The diagram below shows a food web. A, B, C and D are organisms.

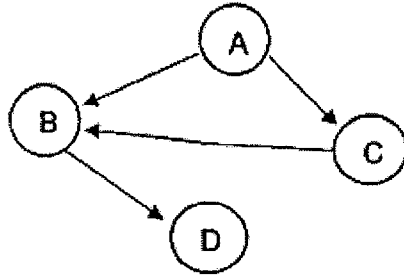

- (a) Which organism is the producer?

[1]

- (b) What would happen to the population of D when the population of A decreases? Explain your answer.

[1]

Organism B can be found in areas where people live. It spreads diseases through its droppings that are harmful to people.

Scientists added substance X to the food of organism B in a city. The graph below shows the changes in the number of births and deaths of organism B after substance X was introduced.

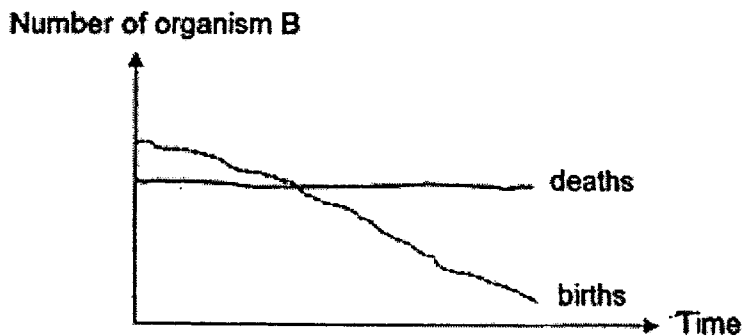

- (c) Using information from the graph, suggest a possible way that substance X acted on organism B. Explain your answer.

[2]

Score	4
-------	---

(d) Other than adding substance X to its food, state another way to control the population of organism B. [1]

Score	1
-------	---

35. An experiment was conducted to test the strength of four different types of paper, A, B, C and D. Each piece of paper was cut to similar sizes, and hung one at a time, onto the set-up shown below.

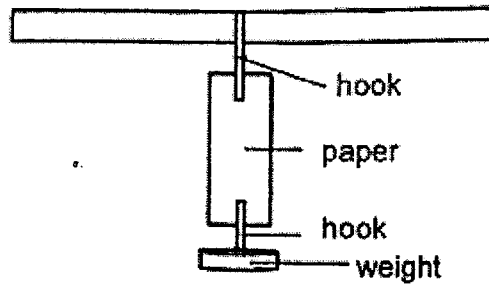

Each weight was added till the paper tore. The data was recorded in the graph below.

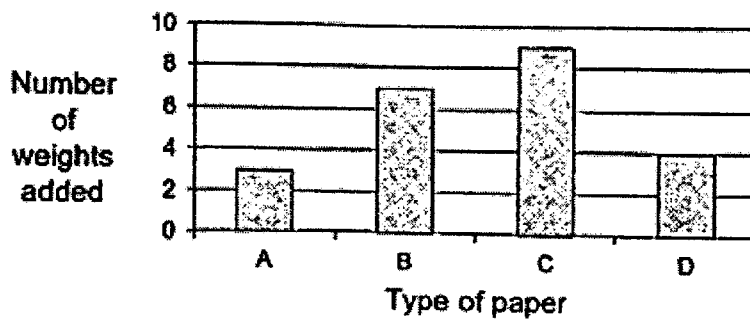

Darius wants to make drink carton as shown below.

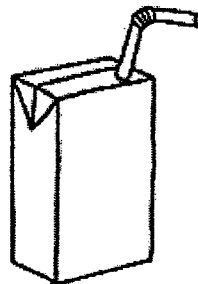

- (a) Which type of paper will be most suitable to make drink carton? Explain why.

[1]

Score	1
-------	---

The drink carton can be folded easily so that it could be thrown into the recycling bin without occupying much space.

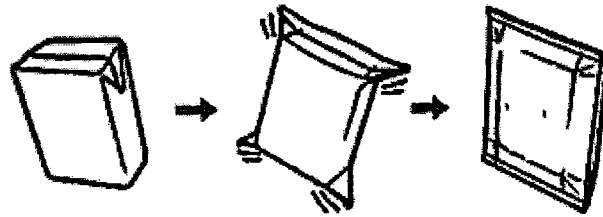

(b) Apart from strength, state 2 other properties that must be considered for the choice of the right material to be made into the paper drink carton. [1]

(i) _____

(ii) _____

Score	1
-------	---

36. Mr Tan used the set-up fixed at the doorway of his shop to count the number of people entering his shop.

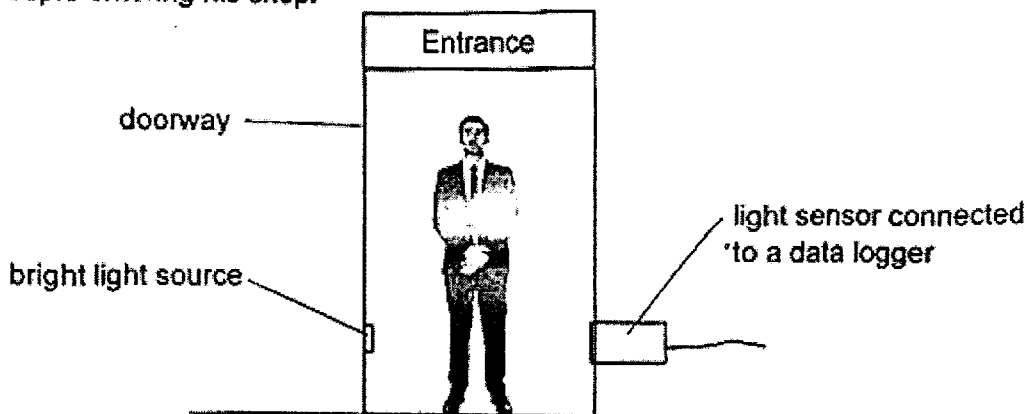

The data recorded is shown in the graph below.

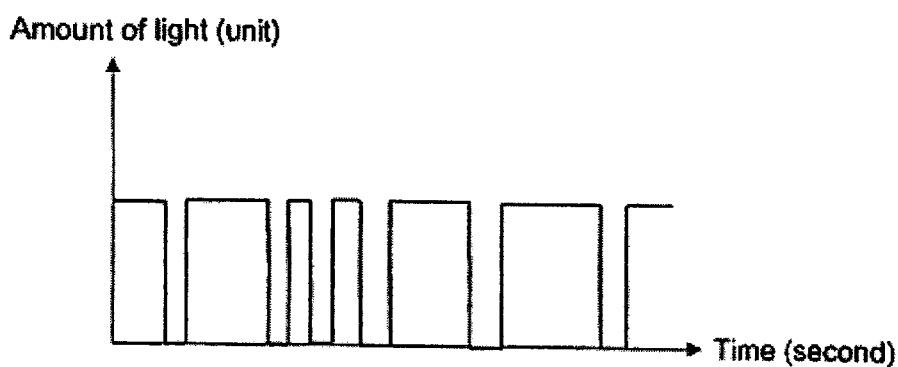

- (a) Based on the graph above, how many people entered Mr Tan's shop? [1]

- (b) State the property of light that enabled Mr Tan to count the number of people entering his shop. [1]

- (c) This might not be an accurate way to count the number of people entering the shop. Explain why. [1]

Score	3
-------	---

37. The diagram shows how gas K can be added to or removed from the air around us.

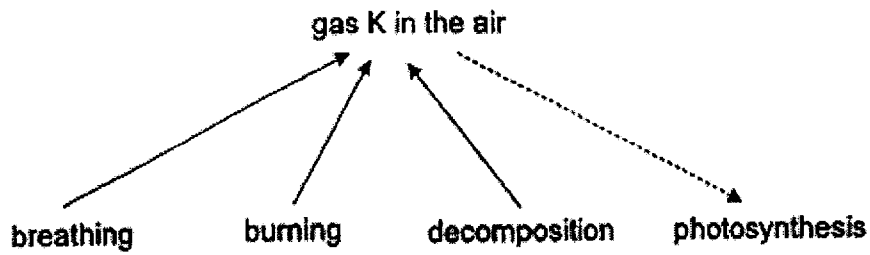

Key

————→ add

-----→ remove

(a) Identify gas K. [1]

Shawn drives his car to work daily. His car runs on petrol.



(b) Explain how driving such cars can lead to global warming. [1]

(c) Suggest a change to Shawn's daily routine to reduce his impact on global warming. [1]

Score	3
-------	---

38. Curling is a sport where players push stones across an icy surface towards a target area. As player A gives the stone a push, player B uses a curling broom to rub the ice vigorously so that the stone will slide over faster and further. A thin layer of water is observed as the curling broom rubs the ice.

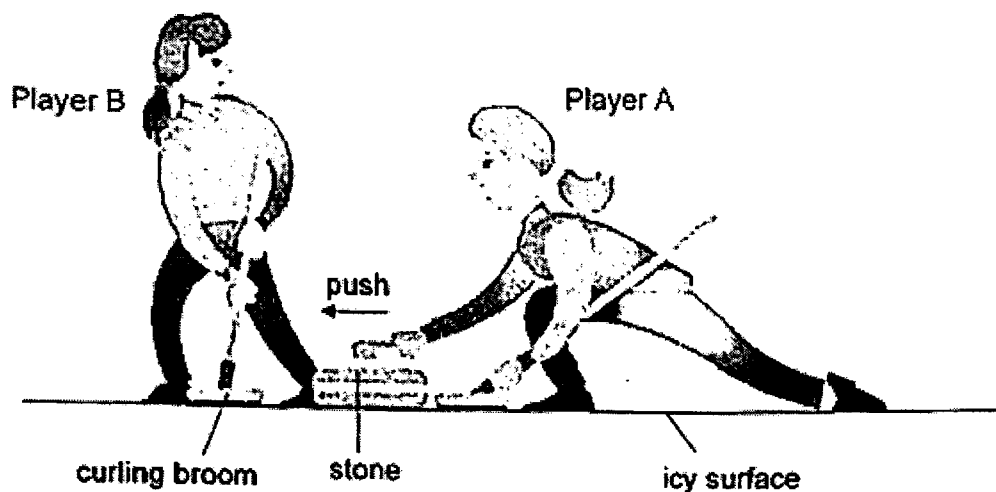

- (a) Explain, in terms of forces, how rubbing the ice vigorously by player B allows the stone to move faster and further. [2]

- (b) Identify the forces acting on the stone as it is moving on the icy surface. [1]

39. Jia Hui sets up a circuit to control the light in a corridor using 2 special switches. Switch 1 can be turned to position A or position B. Switch 2 can be turned to position C or position D. She sets up the circuit so that the bulb will be lit as described in the table below.

Position of switch		Bulb is lit?
Switch 1	Switch 2	
A	C	Yes
A	D	No
B	D	Yes
B	C	No

- (a) The diagram below shows part of the circuit. Complete the circuit below so that the bulb will work as described. [3]

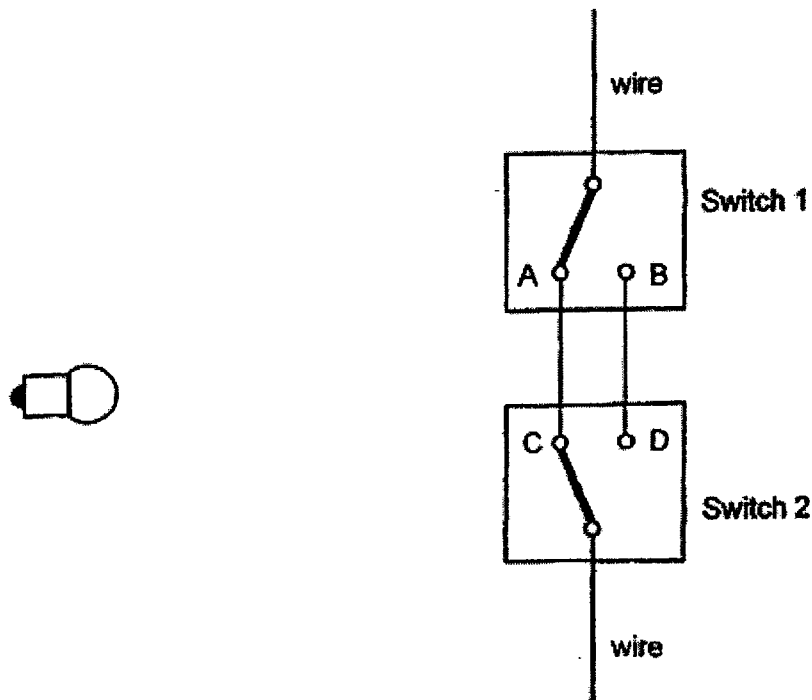

Jia Hui wants to connect another bulb to the circuit without decreasing the brightness of the first bulb when the circuit is closed.

- (b) How should the new bulb be connected to the circuit? [1]

40. Sangeetha prepared 2 set-ups, A and B, as shown below. She used the same type of aquatic plant with the same number of leaves in both set-ups. The lamps in both set-ups are identical and switched on to the greatest light intensity.

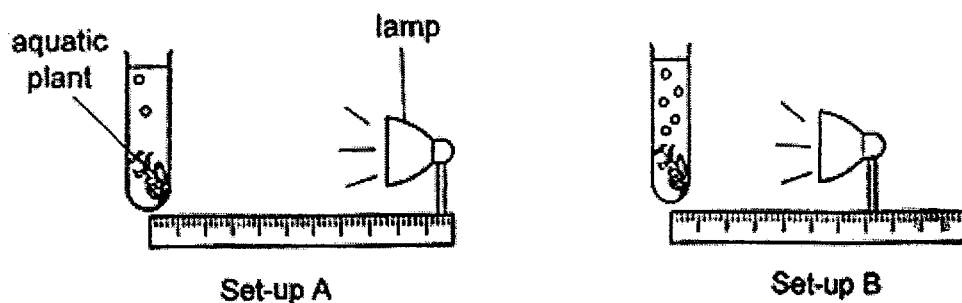

She counted the number of bubbles produced per minute for both set-ups and recorded her results in the table below.

Set-up	Number of bubbles produced per minute
A	18
B	37

- (a) Identify the gas produced. [1]

- (b) What can Sangeetha conclude from the experiment? [1]

- (c) Suggest 2 ways Sangeetha could obtain more reliable results. [2]

Score	4
-------	---

41. Sam has a toy catapult as shown below. When the lever of the toy catapult is pushed down to point A and then released, it launches a stone. The path travelled by the stone is shown by the dotted line.

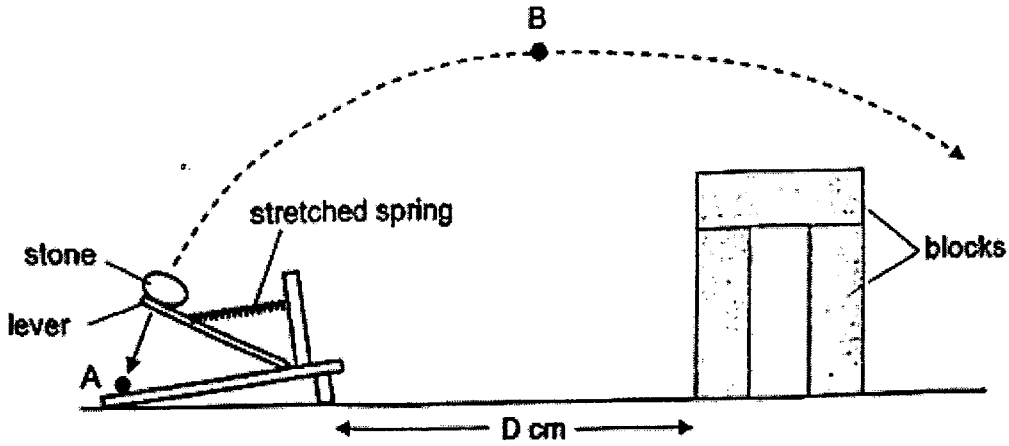

- (a) Fill in the boxes with the main forms of energy when the stone is moving from A to B. [1]

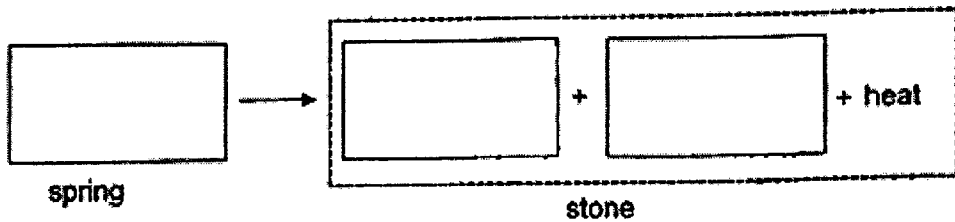

- (b) Using the same set-up and keeping distance D the same, what should Sam do if he wants the stone to hit the blocks? Explain your answer in terms of energy conversion. [2]

Score	3
-------	---

End of Paper

SCHOOL : TAO NAN PRIMARY SCHOOL
LEVEL : PRIMARY 6
SUBJECT : SCIENCE
TERM : 2023 PRELIM

SECTION A

Q 1	Q 2	Q 3	Q 4	Q 5	Q 6	Q 7	Q 8	Q 9	Q 10
4	2	1	2	2	2	2	2	1	3
Q 11	Q 12	Q 13	Q 14	Q 15	Q 16	Q 17	Q 18	Q 19	Q 20
2	2	3	4	4	3	2	1	2	4
Q 21	Q 22	Q 23	Q 24	Q 25	Q 26	Q 27	Q 28		
1	3	2	4	2	4	4	3		

TAO NAN SCHOOL
P6 SCIENCE PRELIMINARY EXAM 2023
Simplified Answer Key (Booklet B)

This answer key only serves as a reference. Variations of students' answers have been accepted if they have shown conceptual understanding.

29 (a)	B. Mushrooms cannot make its own food and reproduces from spores.
29 (b)	Both cannot make their own food.
29 (c)	P has dry scaly skin but C has moist skin.
30 (a)	The leaves/stem would turn red. The roots take in the red-coloured water and the water-carrying tubes in the stem transport the water to the leaves.
30 (b)	It is to act as a control to confirm/ensure/compare that the leaves/stem turning red is due to the red-coloured water being absorbed/transported to the leaves.
31 (a)	The brightly-coloured petals and sweet-smelling nectar attract insects/ animals to pollinate the flowers.
31 (b)	The sticky substance allows the seed to stick to the branches of plant Z so it can germinate on plant Z.
31 (c)	Plant Y will absorb the nutrients/ water from plant Z.
32 (a)	The ice gains heat from the Sun/ surroundings and melts. The water evaporates into water vapour. The water vapour touches the cooler plastic sheet and condenses into water droplets.
32 (b)	Put glass tank on a heated surface OR put ice cubes on top of the clear plastic sheet
32 (c)	Pour the water in the dish into the measuring cylinder and measure the volume of water. Take 50 ml and minus the volume of the water to find the volume of the stone.
33 (a)	Oxygen: decrease Carbon dioxide: increase
33 (b)	Ming Qian and his brother take in oxygen and give out carbon dioxide when they breathe/ respire.
33 (c)	When the lungs/respiratory system take in oxygen faster, the heart beats/pumps faster for the blood/circulatory system to transport oxygen faster around the body. Hence there is less oxygen available in the lift for them to take in. OR When the lungs take in oxygen faster, there is less oxygen available in the lift for them to take in. Less oxygen is transported through the blood/circulatory system to the body.
34 (a)	Organism A
34 (b)	When the population of A decreases, B has less A to eat hence its/B population decreases. D now has less B to eat hence the population of D decreases.
34 (c)	The number of births dropped but the number of deaths remained constant hence substance X caused organism B to be unable to reproduce.
34 (d)	Increase the number of predators/ organism D in the city OR Reduce the number of prey/ A or C in the city OR Kill/hunt/trap B

35 (a)	Paper C. It carried the most weights before tearing/the strongest hence it can hold the (most) drink.
35 (b)	Waterproof Flexible/Flexibility
36 (a)	6 people
36 (b)	Light travels in straight lines / Light can be blocked
36 (c)	People walking side by side may be counted as one person. OR People who exit the shop are also counted by the light sensor.
37 (a)	Carbon dioxide
37 (b)	Burning of petrol increases the amount of carbon dioxide which traps more heat on Earth.
37 (c)	Shawn could take public transport/cycle/carpool to work. OR Drive an electric vehicle instead.
38 (a)	Friction (between the broom and the ice) generates heat causing the ice to melt (into water). The water reduces the friction between the stone and the (icy) surface.
38 (b)	Gravitational force and frictional force
39 (a)	
39 (b)	The new bulb should be arranged in parallel with the first bulb.
40 (a)	Oxygen
40 (b)	As the distance between the lamp and the aquatic plant decreases (increases), the number of bubbles produced per minute increases (decreases).
40 (c)	Repeat the experiment a few times and check for consistency/calculate the average. Conduct the experiment in a dark room.
41 (a)	Elastic potential energy \rightarrow kinetic energy + potential energy + heat
41 (b)	Sam should push the lever less/ Release the lever before it reaches A. The spring will have less elastic potential energy which will be converted into (less) kinetic energy. Hence the stone will travel a shorter distance and /or lower height. OR Sam should push the lever less/ Release the lever before it reaches A. The spring will have less elastic potential energy which will be converted into (less) gravitational potential energy. Hence the stone will travel at a lower height.

