

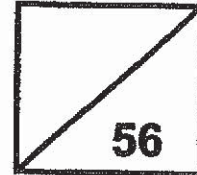

Rosyth School
Mid-Year Examination 2019
SCIENCE
Primary 6



Name: _____

Total
Marks:

Class: Pr 6 _____

Total time for Booklets A and B: 1h 45min

Register No. _____

Date: 16 May 2019

Parent's Signature: _____

Booklet A

Instructions to Pupils:

1. Do not open the booklets until you are told to do so.
2. Follow all instructions carefully.
3. This paper consists of 2 booklets - Booklet A and Booklet B
4. For questions 1 to 28 in Booklet A, shade the correct ovals on the Optical Answer Sheet (OAS) provided using a 2B pencil.
5. For questions 29 to 40, give your answers in the spaces given in the Booklet B.

* This booklet consists of 18 printed pages (including cover page).

For each question from 1 to 28, four options are given. One of them is the correct answer. Make your choice (1, 2, 3 or 4). **Shade the correct oval (1, 2, 3 or 4) on the Optical Answer Sheet.** (56 Marks)

1. The table below shows some information on four living things, P, Q, R and S. A tick (✓) shows that the living thing has the characteristic.

characteristic	living thing			
	P	Q	R	S
Six legs	✓			
Hair as body covering		✓		
Make food				✓
Feathers as body covering			✓	

Based on the table above, which one of the following correctly identifies the groups the living things belong to?

	P	Q	R	S
(1)	insect	bird	plant	fish
(2)	insect	mammal	fish	plant
(3)	bird	plant	mammal	fish
(4)	insect	mammal	bird	plant

2. The diagram shows organisms in a food chain.



What is the source of energy for this food chain?

- | | |
|------------|--------------------|
| (1) sun | (2) water |
| (3) oxygen | (4) carbon dioxide |

3. Refer to the flowchart below. A, B, C and D are groups of living things.

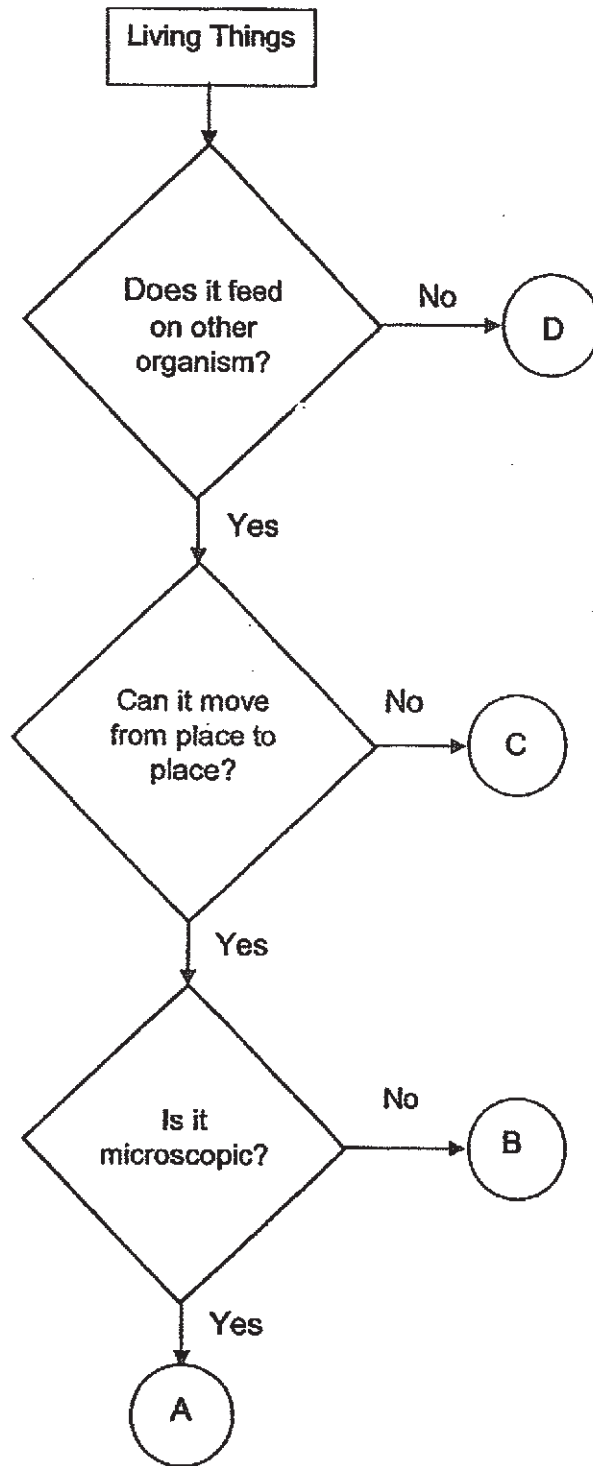

Which one of the above represents a mushroom?

- (1) A
- (3) C

- (2) B
- (4) D

4. Andrew observed three cells X, Y, Z and completed the table below. A tick (✓) indicates that the part was observed in the cell.

parts of cell	cell X	cell Y	cell Z
cytoplasm	✓	✓	✓
cell wall	✓		✓
cell membrane	✓	✓	✓
chloroplasts			✓
nucleus	✓	✓	✓

Based on what he had observed, he classified the three cells X, Y, Z into two groups.

Which one of the following shows the correct classification?

	animal cell	plant cell
(1)	X and Z	Y
(2)	Y	X and Z
(3)	X and Y	Z
(4)	Z	X and Y

5. The diagram below shows tiny openings called stomata found mostly on the underside of the leaves.

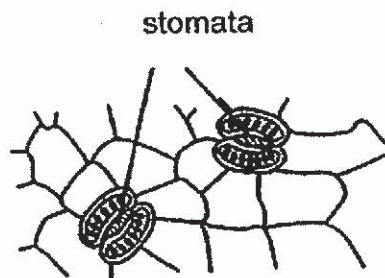

Which one of the following describes the function of the stomata?

- (1) It traps sunlight to make food.
- (2) It transports water from the leaves to all parts of the plant.
- (3) It transports food made in the leaves to all parts of the plant.
- (4) It takes in carbon dioxide from the surrounding during photosynthesis.

6. A potted plant is placed in a black box. The amount of oxygen and carbon dioxide in the box is measured over a few hours.

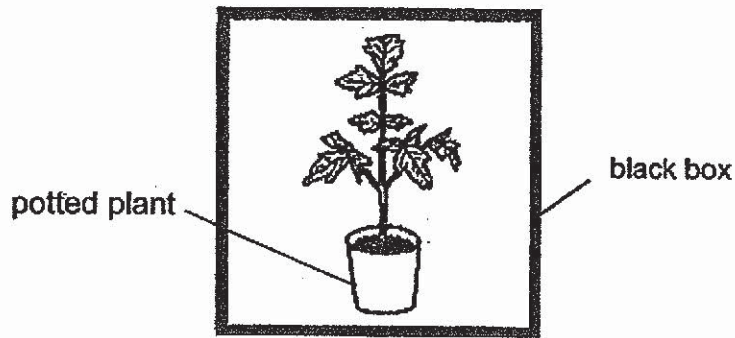

Which one of the following graphs correctly shows the amount of oxygen and carbon dioxide in the box over time?

(1)

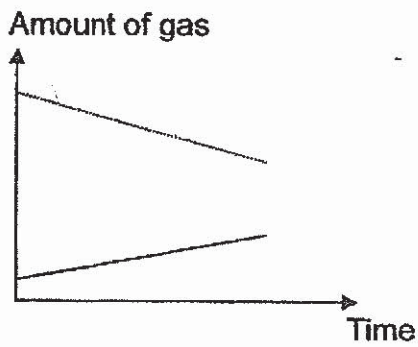

(2)

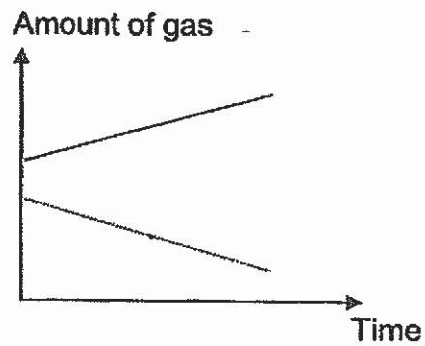

(3)

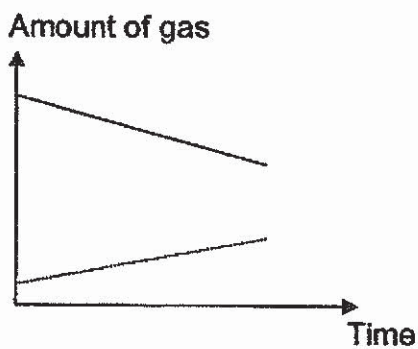

(4)

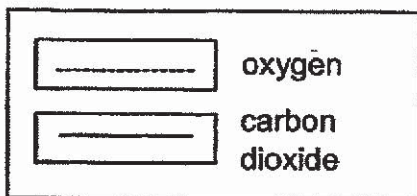
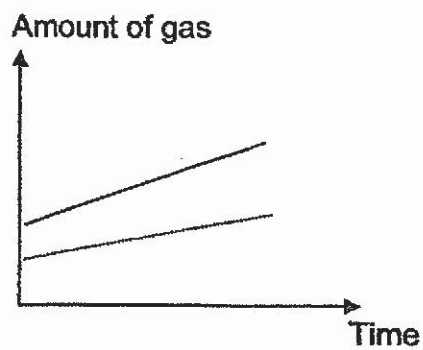

7. Jennifer set up an experiment, as shown in the diagram below.

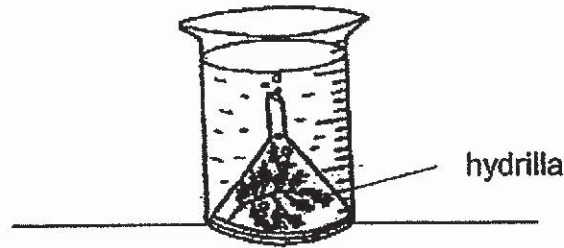

She prepared three similar set-ups and left them at three locations, X, Y and Z in her garden, from 12 noon to 1pm. She counted the number of bubbles produced by the hydrilla.

The rate of photosynthesis of the hydrilla was different at X, Y and Z. This was most likely caused by the amount of _____.

- (1) water
(2) light
(3) carbon dioxide
(4) chlorophyll
8. The diagram shows a grassland habitat.

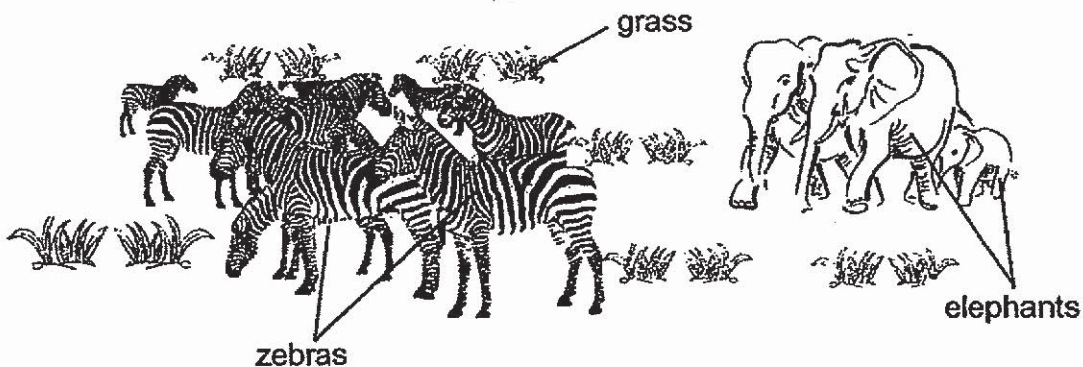

Which one of the statements is not true?

- (1) The group of grass forms one population.
(2) The group of grass and zebra form two populations.
(3) The groups of elephant and zebra form two communities.
(4) The groups of grass, zebra and elephant form one community.

9. Ben caught three different types of organisms, D, E and F, from the school pond. One of them is a plant-eater. He put equal number of water plants into two similar tanks. In one tank, he put the same number of organisms E and D and in the other tank, he put the same number of organism E and F.

He monitored both set-ups over a few weeks and recorded the number of organisms left in each tank at the end of each week. The graphs below show how the number of organisms changed over time. There was no dead organisms in the tanks.

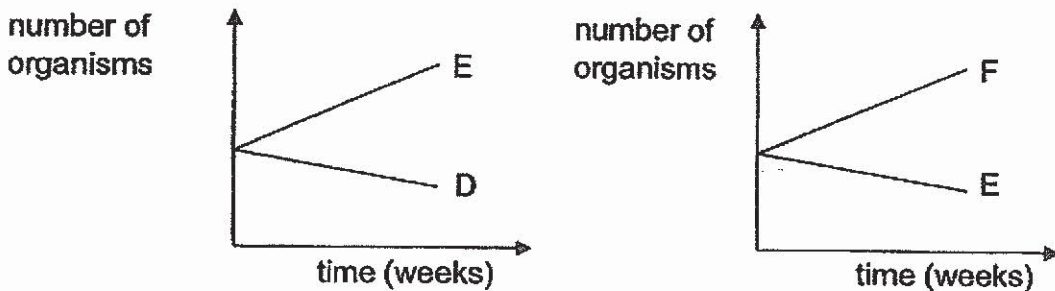

Which one of the following food chains correctly shows the above food relationships?

- (1) Water plant → E → F → D
 - (2) Water plant → D → F → E
 - (3) Water plant → E → D → F
 - (4) Water plant → D → E → F
10. The letters, A, B and C below represent organisms in a community and the arrows show the direction of the flow of energy.

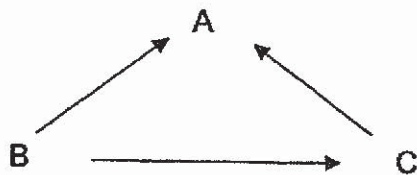

Which of the following correctly represents A, B and C in the community?

	A	B	C
(1)	plants	decomposers	animals
(2)	animals	decomposers	plants
(3)	plants	animals	decomposers
(4)	decomposers	plants	animals

11. The food web below shows the food relationships between four living organisms.

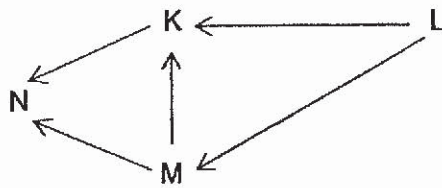

Which one of the following classifications is correct?

	producer	prey	predator	prey and predator
(1)	L	N	M	K
(2)	N	L	K	M
(3)	L	M	N	K
(4)	N	K	L	M

12. Daphne wanted to find out if the presence of chemical J in water would affect the growth of organism V. She used the set-up below for her experiment.

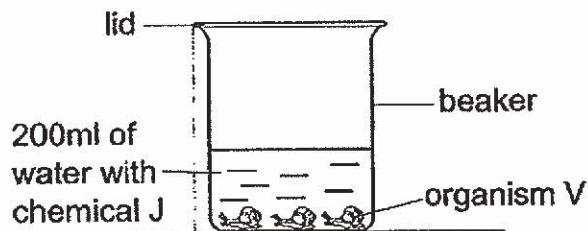

Which one of the following set-ups should she use as a control for her experiment?

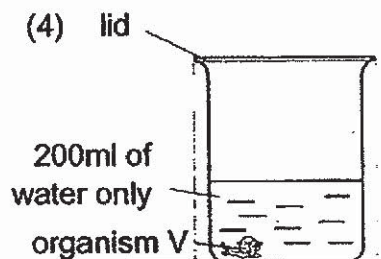
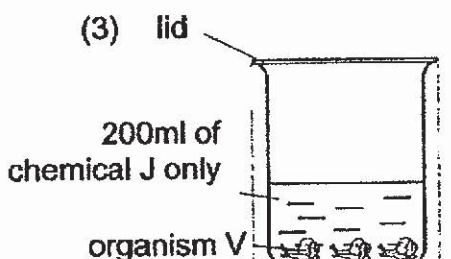
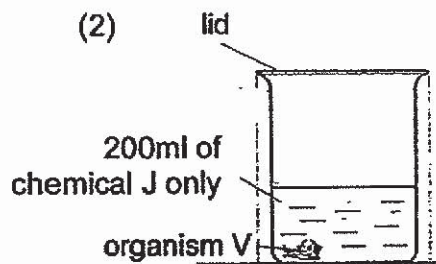
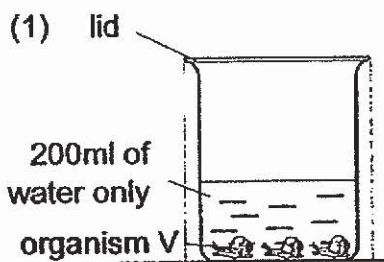

13. Study the food web below.

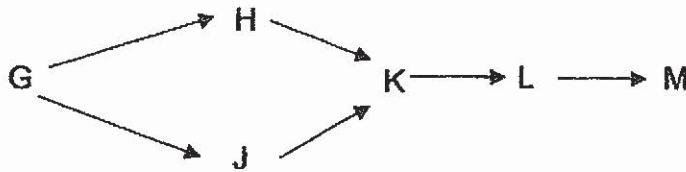

The whole population of K is wiped out by a disease. Which one of the following populations will be affected immediately?

- (1) G
- (2) H
- (3) L
- (4) M

14. Angle wanted to find out how a certain factor will affect the growth of goldfish. She listed the following factors.

- W: Amount of food
- X: Size of fish tank
- Y: Number of goldfish
- Z: Temperature of surrounding

She proposed several experiments which she would like to conduct in the table below.

Which one of the following is possible to find out the effect of a certain factor on the growth of goldfish?

	aim of the experiment	variables kept constant
(1)	To find out if the size of the fish tank affects the growth of the goldfish.	W, X and Z only
(2)	To find out if temperature of water affects the growth of the goldfish.	W, X and Y only
(3)	To find out if overcrowding affects the growth of the goldfish.	W, X and Y only
(4)	To find out if the amount of food given affects the growth of the goldfish.	X and Z only

15. Zachary walked past a lighted street lamp from point P1 to P5 on a dark night.

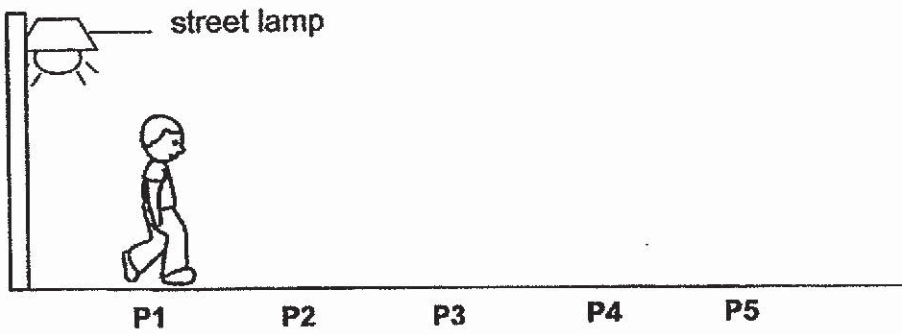

Which one of the following graphs best represents the changes in the length of Zachary's shadow as he walked from point P1 to P5?

(1)

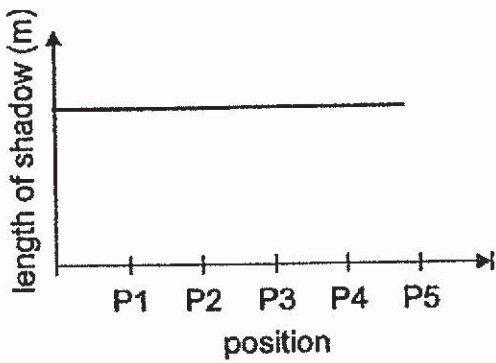

(2)

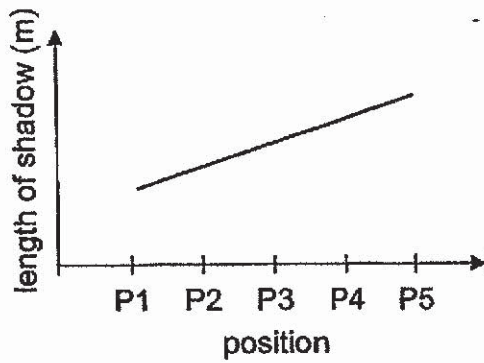

(3)

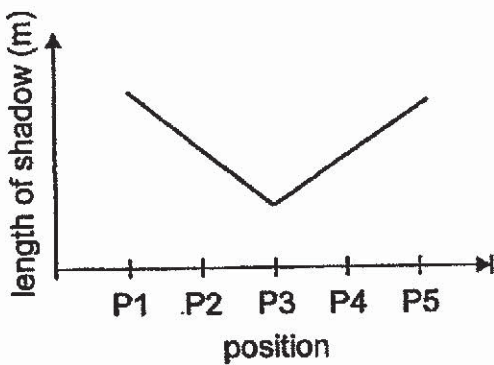

(4)

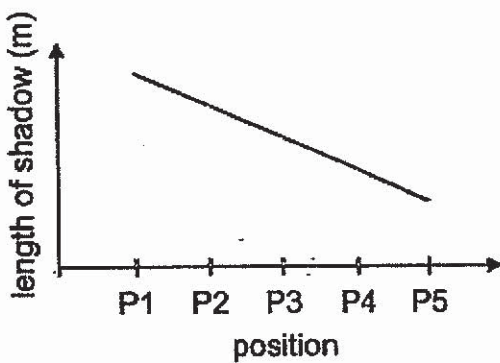

16. There is a special material that can be seen by motorist from a far distance during day and night. Daniel used a similar material to measure the light intensity using a light sensor at positions A, B and C.

He placed the light sensor at A and measured the light intensity as shown below. He repeated the experiment by placing the light sensor at B followed by C.

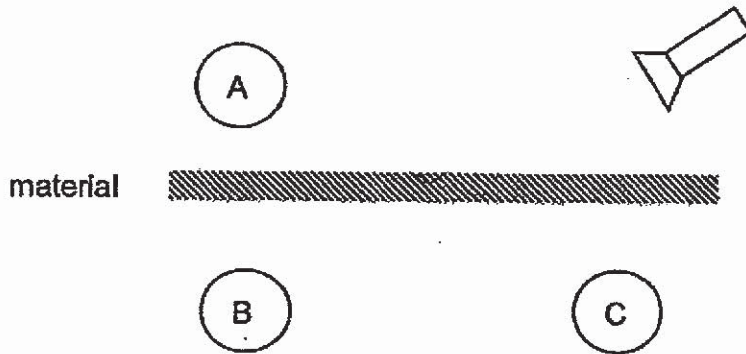

At which position(s) would the light intensity be the highest for this special material?

- (1) A only
(2) B only
(3) A and B only
(4) B and C only
17. Which one of the following statements about energy is false?
- (1) Energy can be stored.
(2) Energy can be used up.
(3) Energy is the ability to do work.
(4) Energy can be transferred from one object to another.

18. Terry started to run down a slope as shown below.

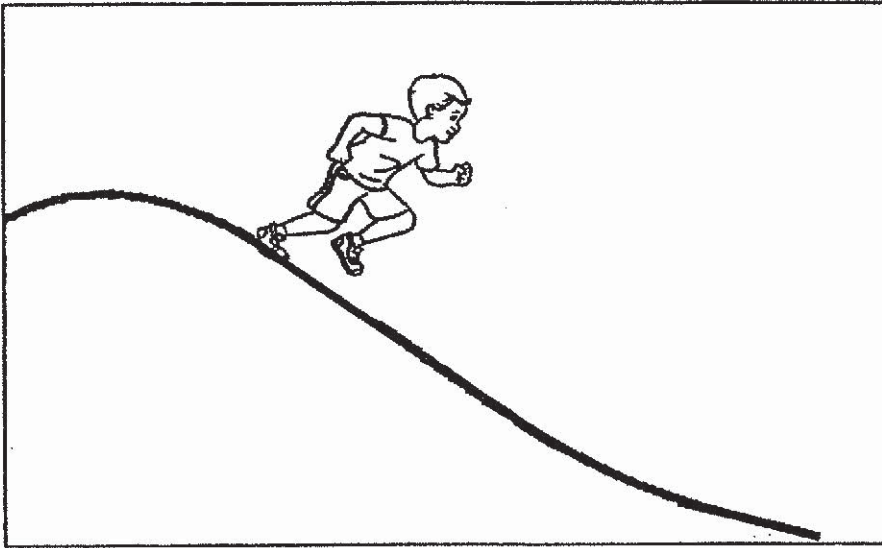

Which one of the following describes the changes in kinetic and potential energy as he runs down the slope?

	kinetic energy	potential energy
(1)	decreases	increases
(2)	increases	decreases
(3)	remains the same	decreases
(4)	increases	remains the same

19. A dynamo is a gadget that converts kinetic energy into electrical energy. Some pupils fixed a dynamo to a wheel as shown below and began turning the wheel. They observed that the bulb lit up after a while. The pupils then turned the pedal of the wheel at different speed and measured the intensity of the light.

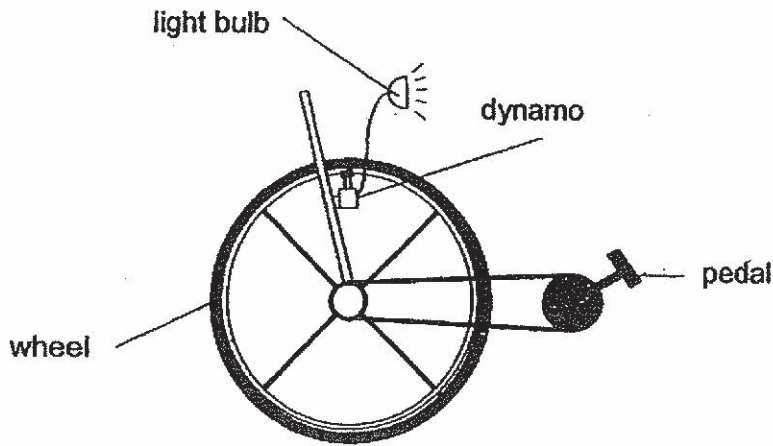

Which one of the following tables correctly shows the most likely results of their investigation?

(1)

speed of wheel (number of turns per min)	intensity of light (lux)
50	60
70	80
90	130
110	180

(2)

speed of wheel (number of turns per min)	intensity of light (lux)
50	60
70	130
90	180
110	80

(3)

speed of wheel (number of turns per min)	intensity of light (lux)
50	180
70	80
90	60
110	130

(4)

speed of wheel (number of turns per min)	intensity of light (lux)
50	180
70	130
90	80
110	60

20. The diagram below shows a battery-operated toy car. When the toy car is switched on, it moves.

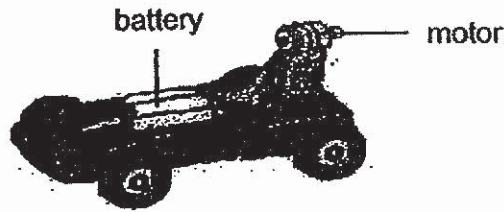

Which one of the following correctly shows the energy conversion taking place when the toy car moves?

- (1) potential energy \longrightarrow kinetic energy
- (2) kinetic energy \longrightarrow electrical energy
- (3) potential energy \longrightarrow electrical energy \longrightarrow kinetic energy
- (4) electrical energy \longrightarrow potential energy \longrightarrow kinetic energy

21. The original length of a spring is 10 cm. Wei Ling did the following actions as shown below.

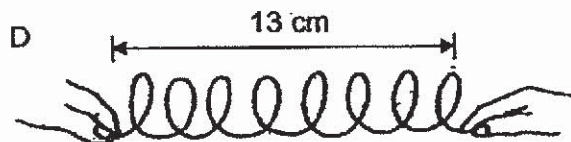
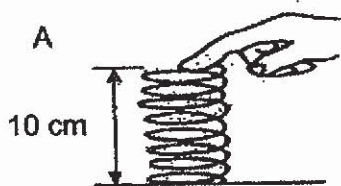

For which actions, the spring would possess potential energy?

- (1) A and C only
- (2) B and D only
- (3) B, C and D only
- (4) A, B, C and D

22. A block of ice was placed in an empty container and left in the kitchen as shown below.

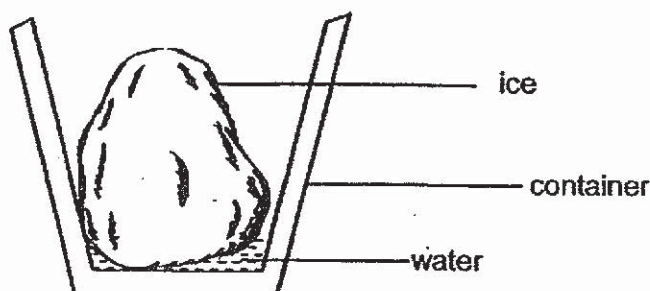

What will happen after some time?

- (1) The temperature of the block of ice will increase.
 - (2) The temperature of the block of ice will decrease.
 - (3) The temperature of the water around the block of ice is 0°C .
 - (4) The temperature of the water around the block of ice is less than 0°C .
23. Study the diagrams of beaker A and beaker B which were left on the table for 15 minutes.

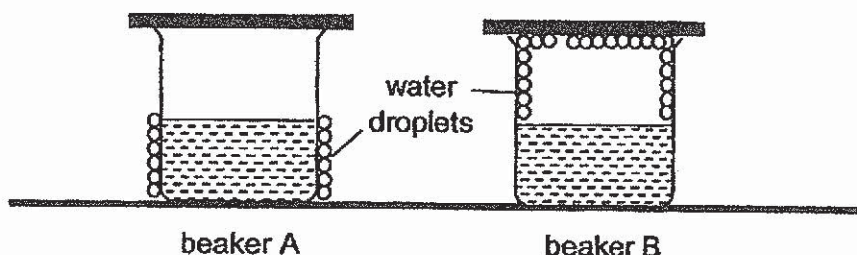

Which one of the following statements is true?

- (1) Beaker A is a better conductor of heat than beaker B.
- (2) The temperature of the water in both glasses is the same.
- (3) The water in beaker A has a higher temperature than the water in beaker B.
- (4) The water droplets formed in beaker B is hotter than the water droplets formed in beaker A.

24. A driver finds that it is more difficult to drive his car uphill. Which of the following forces below slow the car down?

- A: Frictional force
- B: Magnetic force
- C: Gravitational force
- D: Elastic spring force

- (1) A and C only
- (3) A, B, and C only

- (2) B and C only
- (4) B, C and D only

25. Ravi released a metal ball at a height in the bowl as shown below. He observed the metal ball rolled to a position then it rolled back.

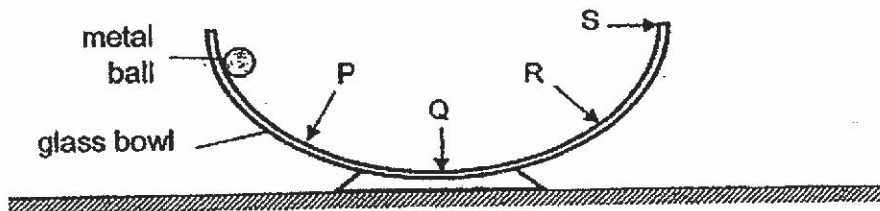

At which position would the metal ball roll back the first time it was released?

- (1) P
- (3) R

- (2) Q
- (4) S

26. Refer to the diagram below. At first a ring magnet was hung on a spring. Then a bar magnet was placed under the ring magnet and the spring stretched less than before.

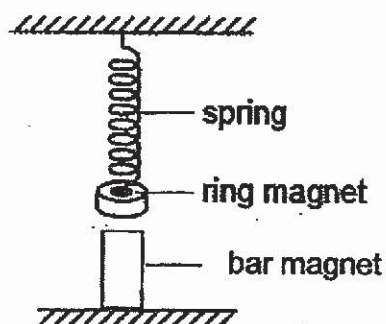

Which of the following force(s) is/are acting on the bar magnet?

- A: Friction
- B: Gravitational
- C: Magnetic

- (1) B only
- (2) C only
- (3) B and C only
- (4) A, B and C

27. Jessie conducted an experiment using the set-up below.



Jessie gave the cube an identical push. The cube moved a distance along the surface of material K before stopping. She repeated the experiment with materials L, M and N. The table below shows her results.

material	distance moved before stopping (cm)
K	8
L	12
M	14
N	16

Jessie added same amount of oil on the four materials, K, L, M and N. Which material will be most slippery?

- (1) K
- (2) L
- (3) M
- (4) N

28. Mary used some blocks and slides to build the set-up as shown below.

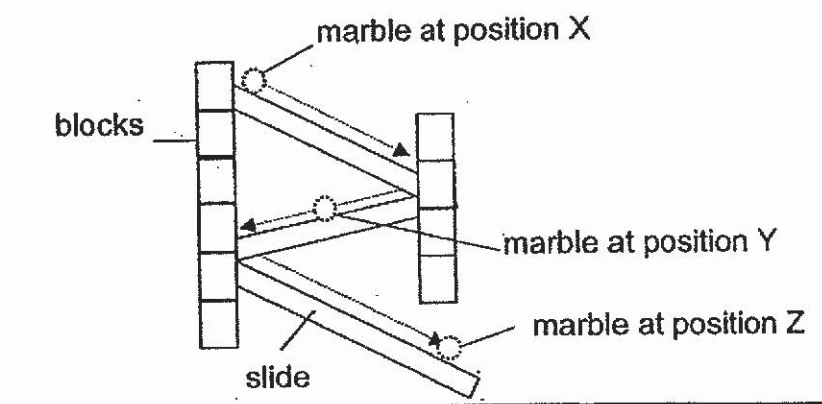

She released a marble at position X and it rolled to position Y and then to position Z.

Which one of the following graphs correctly shows the amount of gravitational force acting on the marble at positions X, Y and Z?

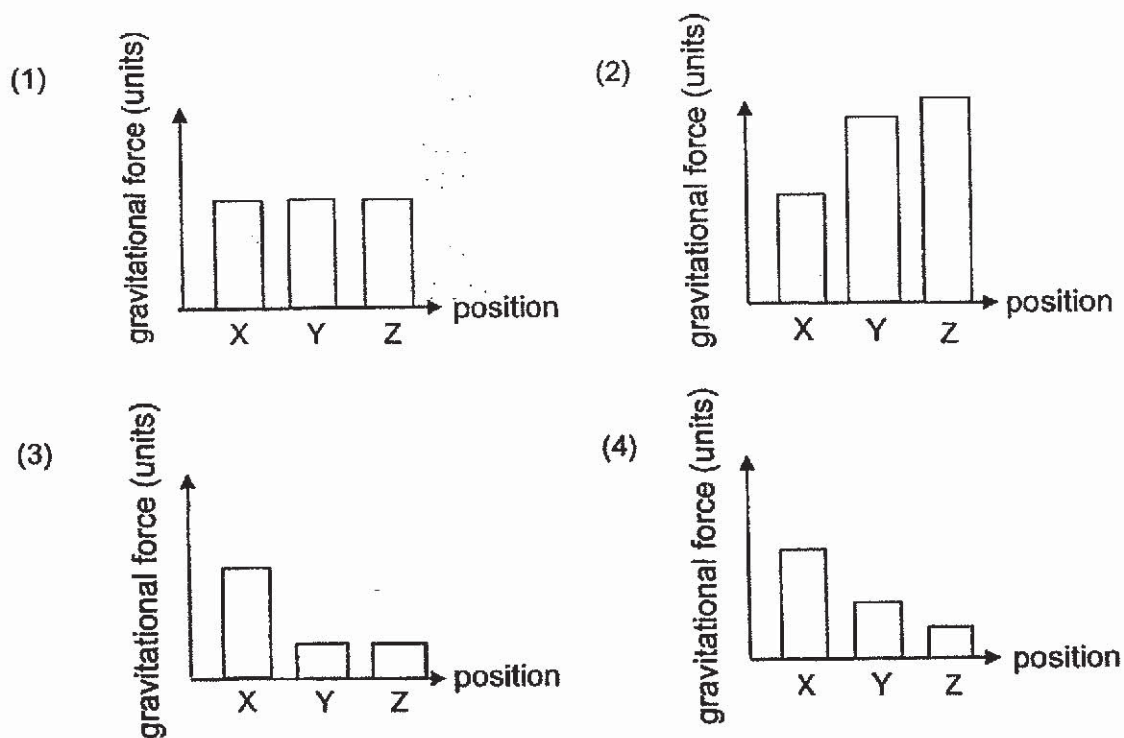

End of booklet A

(Go on to Booklet B)



Rosyth School
Mid-Year Examination 2019
SCIENCE
Primary 6



Name: _____

Total
Marks:

Class: Pr 6 _____

Total time for Booklets A and B: 1h 45min

Register No. _____

Date: 16 May 2019

Parent's Signature: _____

Booklet B

Instructions to Pupils:

1. For questions 29 to 40, give your answers in the spaces given in Booklet B.

	Maximum	Marks Obtained
Booklet A	56 marks	
Booklet B	44 marks	
Total	100 marks	

* This booklet consists of 14 printed pages (including cover page).

For questions 29 to 40, write your answers in the space provided. **(44 Marks)**

29 Read the following statements about mammals.

A: An animal is a mammal because it has 4 legs.

B: An animal is a mammal because it can lay eggs.

C: An animal is a mammal because it has hair or fur on its outer covering.

(a) Which statement would you agree with the most? Explain why. [1]

Study the classification table.

animals	
group 1	group 2
reptiles	fish

(b) Name the characteristics that will help you put reptiles and fish into two groups as shown above. [1]

Reptiles: _____

Fish: _____

30 Andy conducted an experiment with 3 set-ups, X, Y and Z, as shown below. Similar plants were put in glass containers, watered and placed in an open field for a few hours during the day.

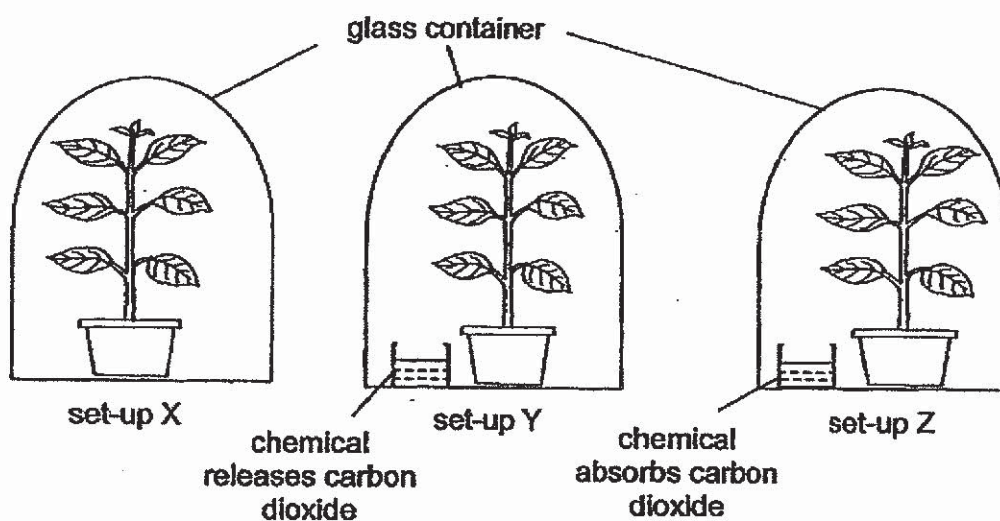

(a) What is the changed variable in the above experiment? [1]

(b) Which set-up X, Y or Z will contain the most amount of oxygen after a few hours? Explain your answer. [1]

(c) In which set-up, will the plant not survive after some time? Explain your answer. [1]

(d) What is the purpose of having set-up X? [1]

31 Simon drew the diagram below showing how plants make food.

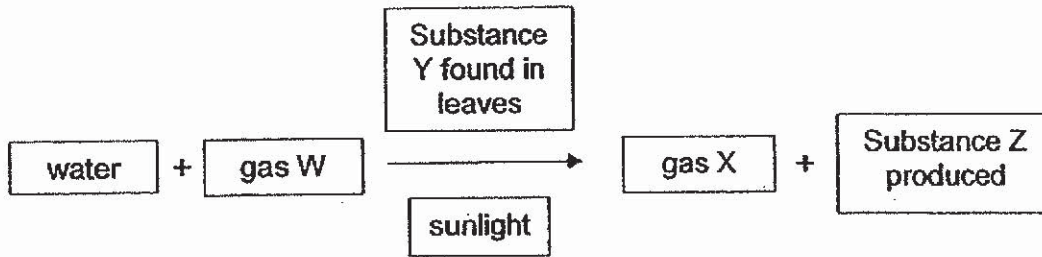

(a) Identify the following: [2]

gas W: _____

gas X: _____

Substance Y: _____

Substance Z: _____

After that, Simon went to find out how the temperature of the water affects the number of bubbles produced by plant A in one minute. He set up the experiment as shown below in a bright room.

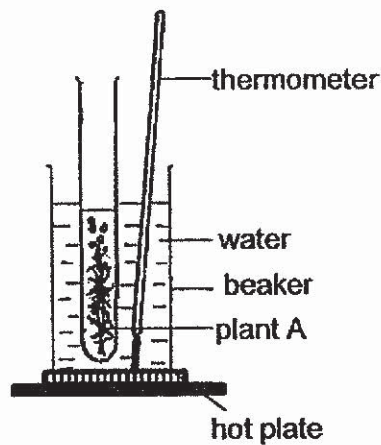

(b) What is the purpose of the hot plate? [1]

(Question 31 continues on page 5)

He collected the data and recorded his results in the table below.

Temperature of water (°C)	10	20	30	40	50
No. of bubbles of gas X per minute	2	8	10	6	2

- (c) State the relationship between the temperature of water and the rate of photosynthesis [2]

32 Farah used sensors to measure the light intensity and temperature of air in two different habitats, garden and open field. She recorded the readings in the table as shown below.

habitat	light intensity (lux)				temperature of air (°C)			
	8 am	11 am	2 pm	5 pm	8 am	11 am	2 pm	5 pm
garden	1345	2006	2879	1389	30	32	33	29
open field	1552	2881	3356	1775	31	33	34	30

(a) Based on the data above, describe how the temperature of air is affected by light intensity. [1]

(b) Name two other physical factors that can affect the temperature of air in the two habitats? [2]

33 In a pond, animals and plants depend on one another to form the pond community.

(a) Besides providing food for the animals in the pond, suggest two other reasons why plants are important to the animals [2]

i) _____

ii) _____

(b) If there is too much algae growing on the surface of the pond, how will this growth affect the plants growing inside the pond? [1]

34 Study the food web below.

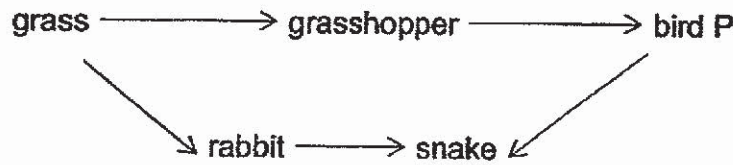

(a) Identify one food chain from the above food web. [1]

(b) Explain why grass is important to all the organisms in the above food web. [2]

(c) A population of bird Q was introduced into the habitat. James said that due to this introduction, the bird P population will decrease while John said that bird P population will increase.

i) Explain how it is possible for James to be correct. [1]

ii) Explain how it is possible for John to be correct. [1]

- 35 The set-up below shows light shining on two shapes A and B made of cardboard. They are placed at different distances from the torch.

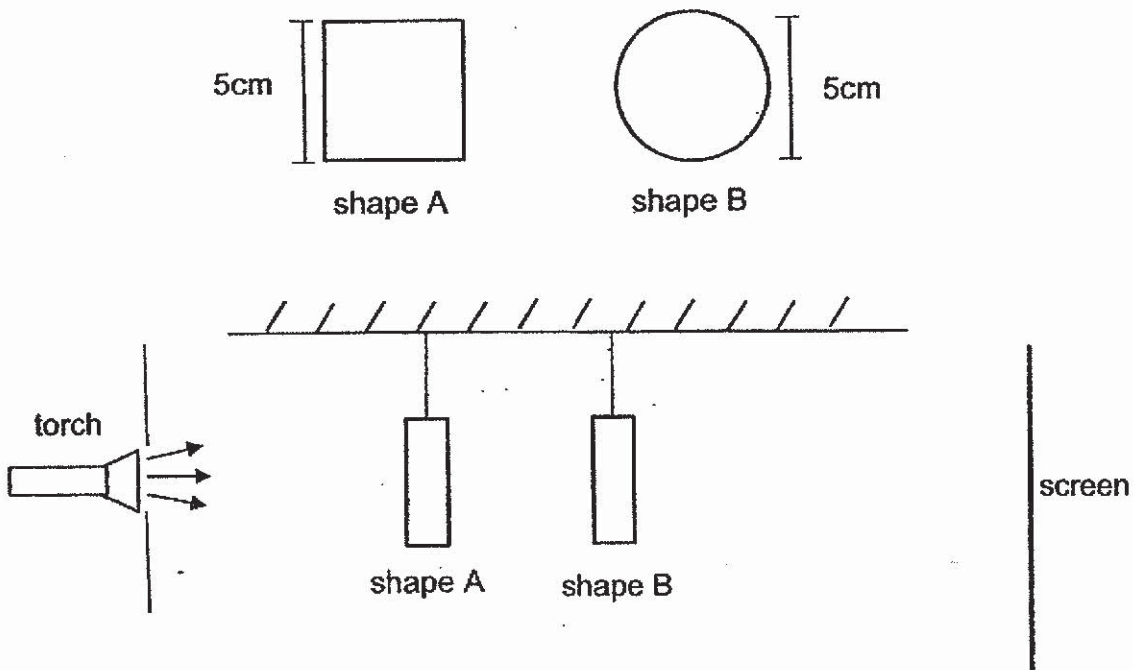

- (a) Draw the shadow of the object on the screen provided below. [1]

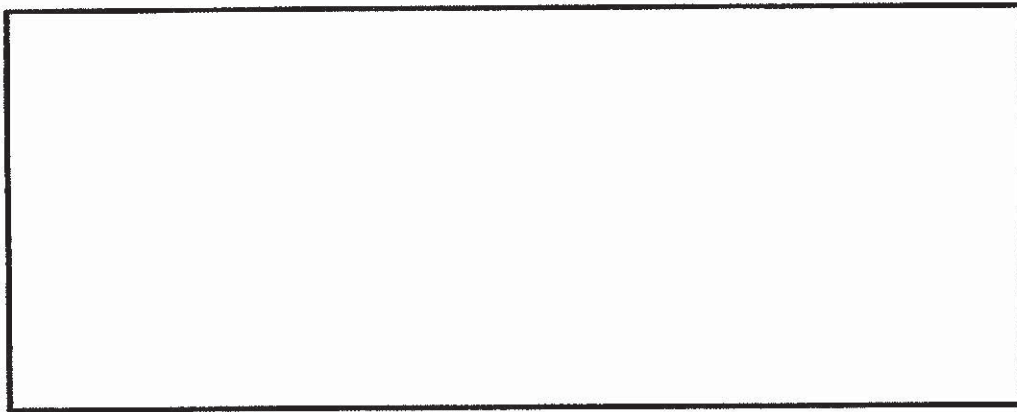

- (b) Explain your answer in (a). [1]

36 Benny put some fish balls at room temperature into a pot of boiling soup as shown in the diagram below.

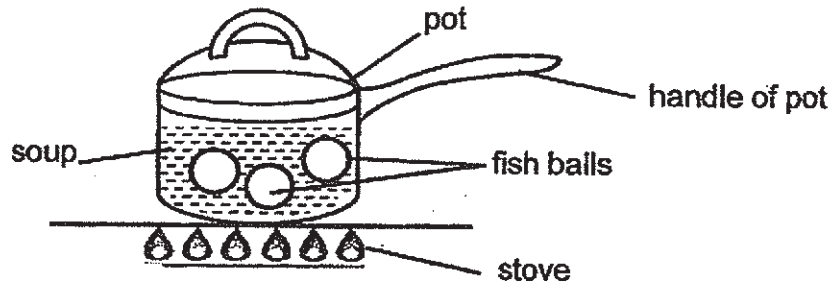

(a) The temperature of the soup decreased after adding the fish balls. Explain why. [1]

The diagram below represents a fish ball. Temperature was recorded at positions, A and B of the fish ball in the soup as shown below.



(b) The temperature at point A of the fish ball is lower than at point B of the fish ball. State the property of heat to explain the above observation. [1]

(c) Give an example of materials to make the pot and the handle of the pot. [2]

Pot: -----

Handle of pot: -----

37 Study the set-up below.

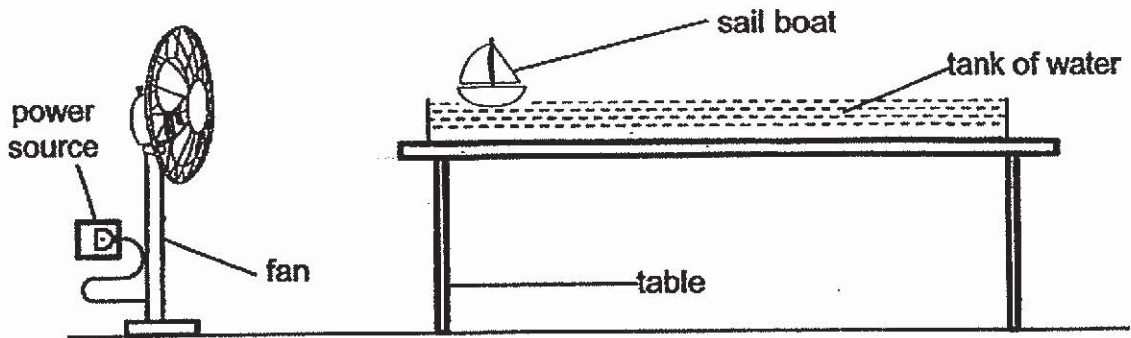

Sarah switched on the fan which was connected to the power source and observed that the sail boat moved across the tank of water.

(a) Write down the energy conversion for the above observation in the boxes below. [1]

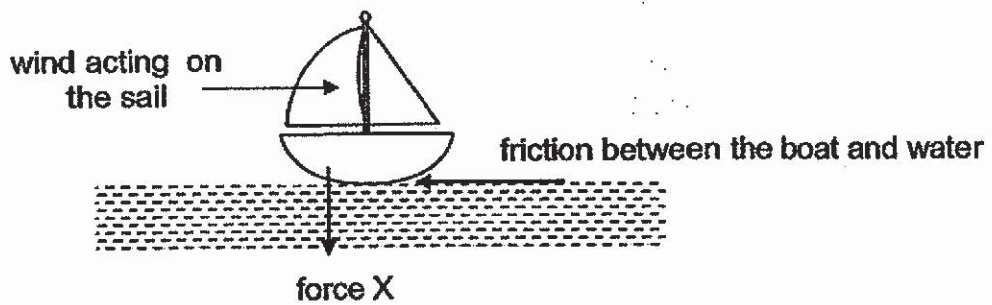
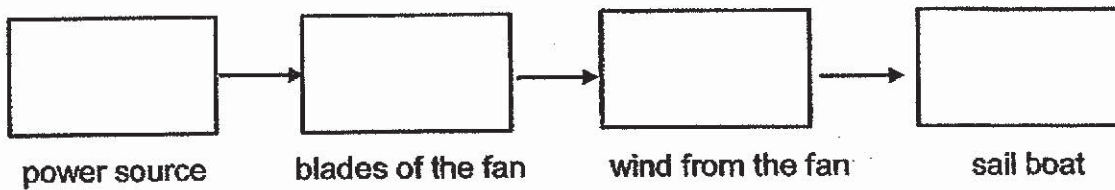

(b) Name the force X. [1]

(c) If Sarah increase the size of the sail, explain how this will be an advantage. [2]

- 38 Study the set-up below. When the water dripped from container A, the water wheel would spin and the generator would generate energy for the bulb to work.

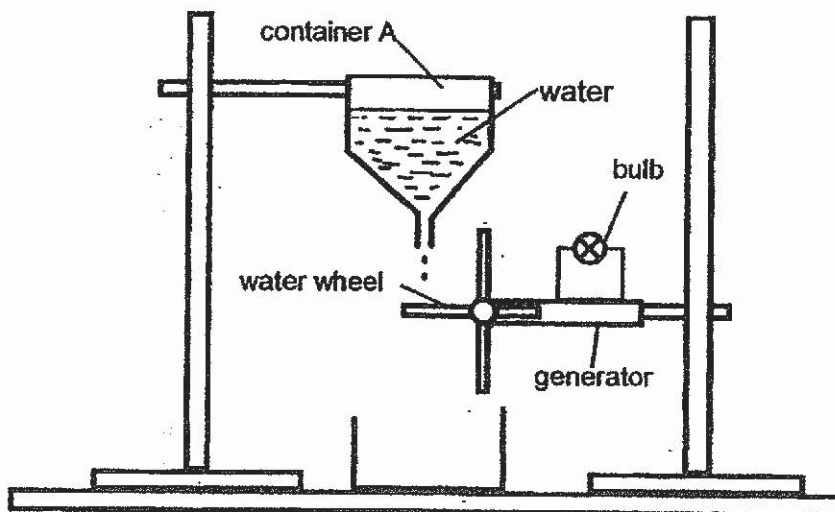

- (a) Name the source of energy for the above set-up. [1]

- (b) Using the concept of energy conversion, describe how the turning wheel cause the bulb to work. [2]

- (c) Using the same items in the set-up, suggest an action and give a reason why the action taken enables the bulb to light up more brightly. [2]

Action taken:

Reason:

39 Alastair conducted an experiment to investigate the effect of a force on two different springs A and B. He measured the length of the spring before and after a 10g load was placed on top of each spring. The results are shown in the graph below.

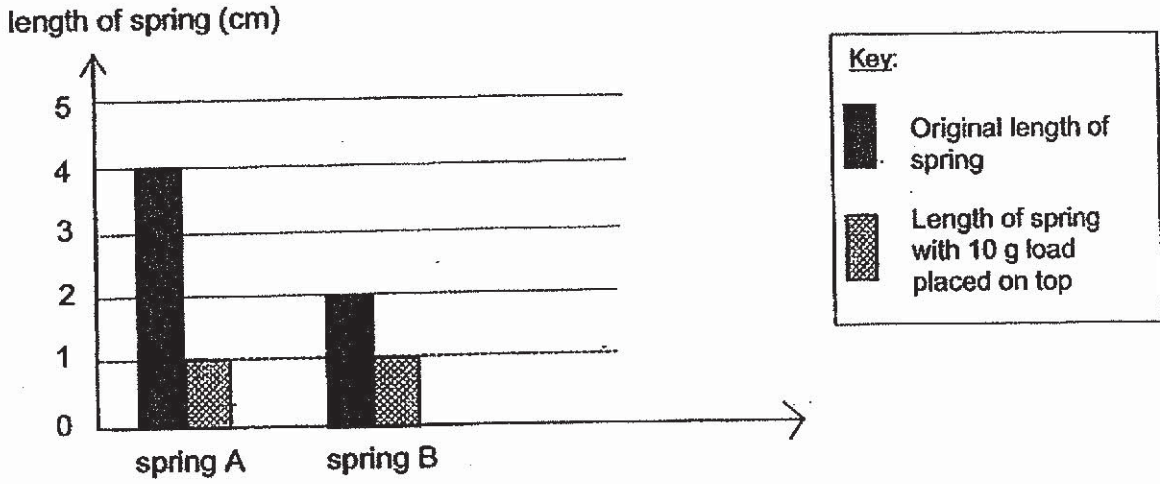

(a) Give a reason why the compression of spring A is more than spring B. [1]

Study the bottle, which is being used to dispense liquid soap.

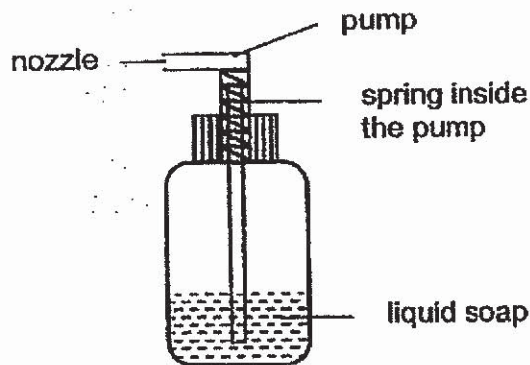

When the pump is being pushed down, the spring compresses and pushes the air and liquid soap into the bottle.

(b) Describe what will happen when the pump is released. [2]

- 40 Steven took three identical pieces of paper and made three similar planes of different sizes as shown below.

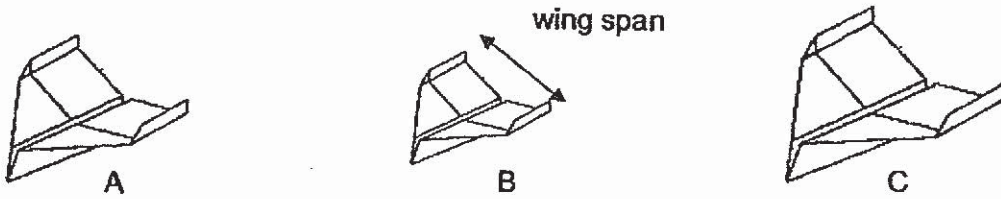

He had a paper plane launcher that is able to throw paper planes. He used the launcher to throw the three paper planes. He recorded the time taken for each plane to stay in the air.

The table below shows the results.

plane	wing span of the paper plane (cm)	time for plane to stay in the air (sec)
A	4	20
B	3	18
C	5	25

- (a) Why must he use a plane launcher to throw the paper plane? [1]

- (b) Based on the results above what can Steven conclude about the experiment? [1]

(Question 40 continues on page 14)

(c) (i) Will the pathway taken by the plane be straight or curved? Put a tick in the correct box. [1]

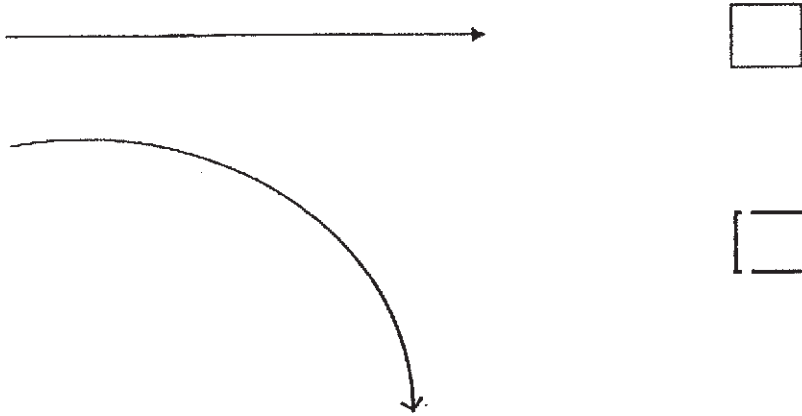

(ii) Explain why. [1]

End of Paper

SCHOOL : ROSYTH PRIMARY SCHOOL
 LEVEL : PRIMARY 6
 SUBJECT : SCIENCE
 TERM : 2019 SA1

SECTION A

Q 1	Q2	Q3	Q4	Q5	Q6	Q7	Q8	Q9	Q10
4	1	3	2	4	1	2	3	4	4
Q 11	Q12	Q13	Q14	Q15	Q16	Q17	Q18	Q19	Q20
3	1	3	2	2	1	2	2	1	3
Q 21	Q22	Q23	Q24	Q25	Q26	Q27	Q28		
3	3	4	1	3	3	4	1		

SECTION B

Q29)	<p>a)Statement C. Only mammals have hair or fur on its outer covering.</p> <p>b)Reptiles: has lungs</p> <p>Fish : has gills</p>
Q30)	<p>a)The amount of carbon dioxide in the glass containers.</p> <p>b)Set up Y. Set up Y will have the most carbon dioxide, allowing the plant in it to photosynthesise at the fastest rate, producing the most amount of oxygen.</p> <p>c)Set up Z. Set-up Z has a chemical that absorbs carbon dioxide, so there will be no carbon dioxide for the plant in set-up Z to photosynthesise, causing it to not survive.</p> <p>d)To compare that the amount of carbon dioxide is the only variable affecting the rate of photosynthesis.</p>
Q31)	<p>a)gas W : carbon dioxide</p> <p>gas X : oxygen</p> <p>Substance : chlorophyll</p>

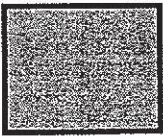
	<p>Substance : sugar</p> <p>b)The hot plate heats up the water to increase the temperature of the water.</p> <p>c)From 10°C to 30°C as the temperature of water increases, the rate of photosynthesis also increases, but from 40°C to 50°C, as the temperature of water increases, the rate of photosynthesis decreases.</p>
Q32)	<p>a)As the light intensity increases, the temperature of air also increases.</p> <p>b)Amount of water and the wind speed.</p>
Q33)	<p>a)i)Plants give out oxygen for the animals during photosynthesis. ii)Plants also provide shelter for the animals.</p> <p>b)If there is too much algae growing on the surface of the pond, they will block out most light from the plants growing inside the pond, so they will photosynthesise at a slower rate and make lesser food.</p>
Q34)	<p>a)grass→rabbit→snake</p> <p>b)The grass is a food produce and will make its own food. The other organisms depend directly or indirectly on it for food.</p> <p>c)i)Bird Q feeds on bird P so its death rate becomes higher than its birth rate. ii)Bird P is the predator of bird Q so bird P can also feed on bird on bird Q, so bird P will have more food and thus the population of bird P will increase.</p>
Q35)	<p>a) </p> <p>b)Shape A blocks all the</p>
Q36)	<p>a)The fish balls are in the soup.</p> <p>b)Heat travels from the warmer place to a cooler place.</p> <p>c)Pot : metal Handle of pot : plastic</p>
Q37)	<p>a)Electrical energy → kinetic energy → kinetic energy → kinetic energy</p> <p>b)Gravitational force.</p>

	<p>c)As the size of the sail increases, the amount of wind in contact with the sail will increase. More kinetic energy of the wind will be converted to more kinetic energy of the boat to move it further.</p>
Q38)	<p>a)The water in container A.</p> <p>b)The kinetic energy of the turning wheel will be converted into electrical energy of the generator, allowing the bulb to work.</p> <p>c)Action taken : Place the water wheel lower.</p> <p>Reason :More kinetic energy of the dripping water will be converted to more electrical energy of the generator, allowing the bulb to lit more brightly.</p>
Q39)	<p>a)Spring A is thicker than spring B.</p> <p>b)When the pump is released, the spring inside the pump will go back to its original length.</p>
Q40)	<p>a)To ensure that the amount of force acting on the paper planes is the same for each set up. This is to compare and confirm that the wing span of the paper plane is the only variable affecting the time for the paper planes to stay in the air.</p> <p>b)As the wing span of the paper plane increase, the time for the plane to stay in the air also increase.</p> <p>c)i) </p> <p>ii)The gravitational pull of the earth acted on the paper plane, causing it to be pulled to the ground. Thus , the pathway taken by the plane will be curved.</p>

