

Anglo-Chinese School (Junior)



SEMESTRAL ASSESSMENT 1 (2019)

PRIMARY 6

SCIENCE

BOOKLET A

Friday

17 May 2019

1 hr 45 min

Name: _____ () Class: 6.()

INSTRUCTIONS TO PUPILS .

- 1 Do not turn over the pages until you are told to do so.
- 2 Follow all instructions carefully.
- 3 There are 28 questions in this booklet.
- 4 Answer ALL questions.
- 5 Shade your answers in the Optical Answer Sheet (OAS) provided.

This question paper consists of 19 printed pages (inclusive of cover page).

Booklet A

For each question from 1 to 28, four options are given. One of them is the correct answer. Make your choice (1, 2, 3 or 4). Shade your answer on the Optical Answer Sheet.

[56 marks]

1. The flowchart shows how some matter can be classified.

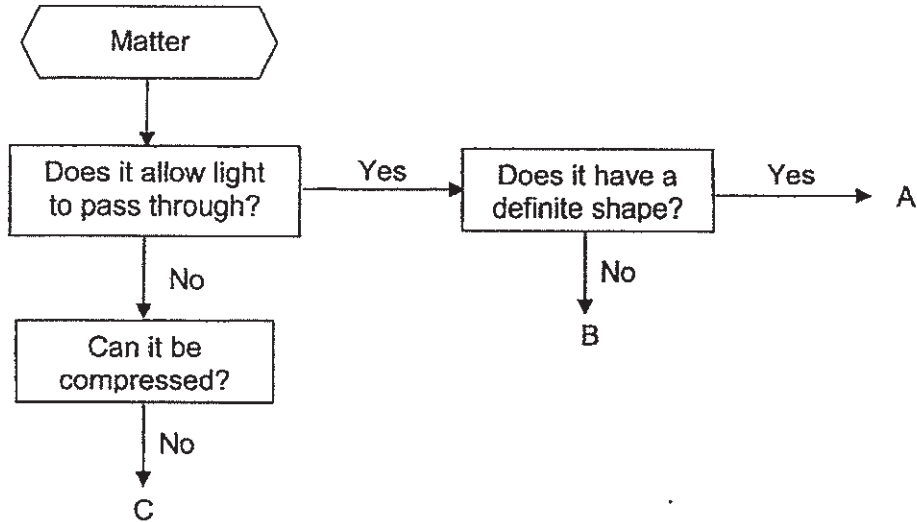

What do A, B and C represent?

	A	B	C
(1)	glass	cardboard	water
(2)	water	glass	cardboard
(3)	glass	water	cardboard
(4)	glass	cardboard	water

cardboard
glass

2. Study Animals X and Y.



Animal X

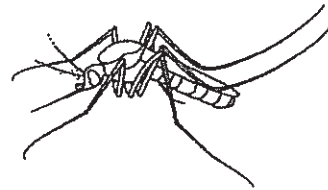

Animal Y

Which of the following comparisons between their life cycles is correct?

	Animal X	Animal Y	
(1)	Its young moults.	Yes	No
(2)	Its young has wings.	No	Yes
(3)	The young looks like the adult.	Yes	No
(4)	There are 4 stages in its life cycle.	Yes	Yes

3. The diagram shows a fungus.



fungus

Which of these statements correctly describes how the fungus grow?

- (1) It gets food from living things that are dead or alive.
 - (2) It disperses its seeds by air to reduce overcrowding.
 - (3) It needs a cold, bright and dry environment to grow well.
 - (4) It continues to grow as long as it can make its own food.
4. A bumper car at amusement parks has a large rubber bumper all around it. This helps to protect the driver and bumper car when a collision occurs.

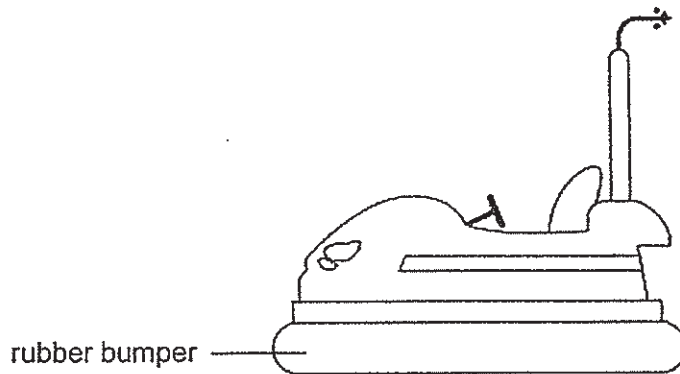

Which property of the rubber bumper is most important to ensure safety?

- (1) flexibility
- (2) waterproof
- (3) transparency
- (4) ability to float

5. The diagram shows how Flower W grows from a flower to a fruit.

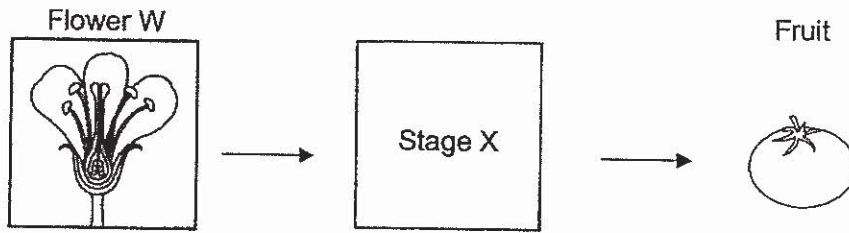

Which of the following statements correctly describes what happened in Stage X?

- A Fertilisation took place
- B The petals, stigma and anthers withered
- C The ovule developed into a seed.

- (1) A only
 - (2) A and B only
 - (3) A and C only
 - (4) A, B and C
6. Study the flowchart.

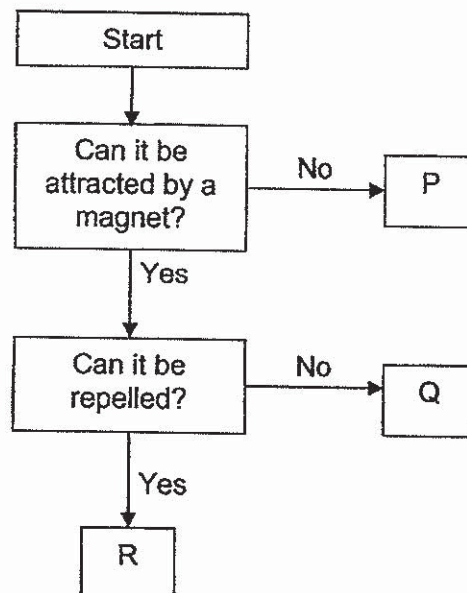

Based on the flowchart, which of the following statements are correct?

- A P is non-magnetic.
- B Q can be made of copper
- C R can attract magnetic objects.
- D P and Q are made of magnetic material.

- (1) A and C only
- (2) B and D only
- (3) A, B and C only
- (4) A, C and D only

7. The diagram shows sperms and an egg.

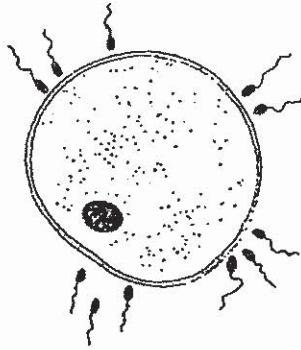

Which of the following statements are true?

- A The sperm and egg fuse during fertilisation.
- B The genetic information from both parents are found in the fertilised egg.
- C The fertilised egg develops in the womb of the female reproductive system.

- (1) A and B only
- (2) A and C only
- (3) B and C only
- (4) A, B and C

8. In the diagram, A, B, C and D represent different processes that result in the change in state of water.

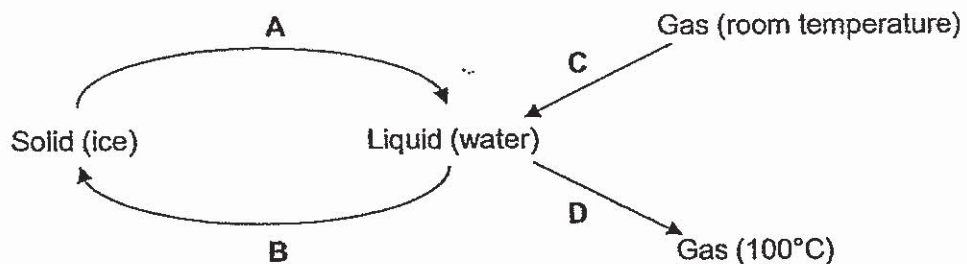

Which of the following correctly states processes A, B, C and D?

	A	B	C	D
(1)	freezing	melting	evaporation	condensation
(2)	melting	freezing	condensation	boiling
(3)	freezing	melting	condensation	evaporation
(4)	melting	freezing	evaporation	boiling

9. Tessa used a bar magnet to repeatedly stroke an iron bar as shown.

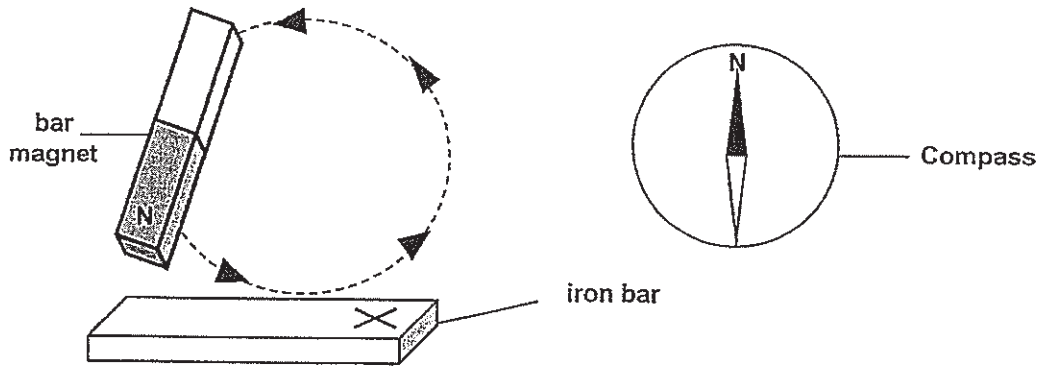

She then placed the iron bar next to a compass. Which of the following two are possible observations?

	Possible Observation	
A		
B		
C		
D		

- (1) A and B
 (2) B and C
 (3) C and D
 (4) A and D

10. William placed two similar plastic Cones, A and B, on a basin of water in the garden at noon. Cone A had a larger opening at its base than Cone B.

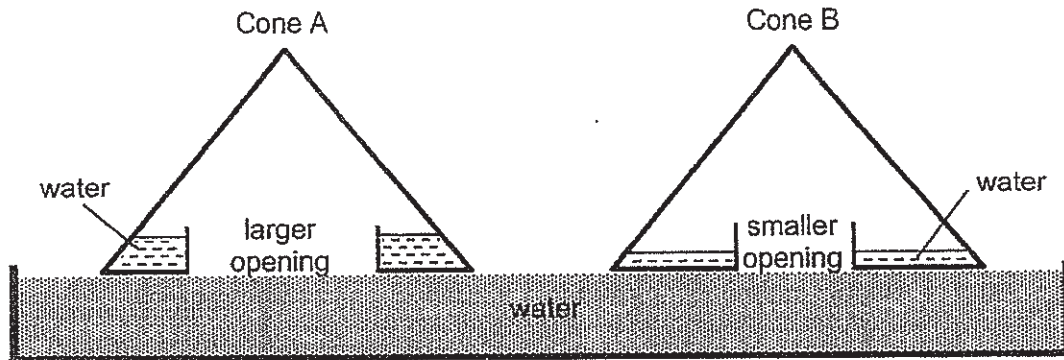

After 2 hours, William observed that there was more water collected in Cone A than in Cone B. Which of the following correctly explains the reason?

- (1) There was more water under Cone A than Cone B.
 - (2) There was a bigger exposed surface area under Cone A than Cone B.
 - (3) The contact surface area between the base of the cone and the water is greater under Cone B than Cone A.
 - (4) There was a bigger surface area for water vapour to condense under Cone A than Cone B.
11. The diagram shows how some substances are transported in a plant.

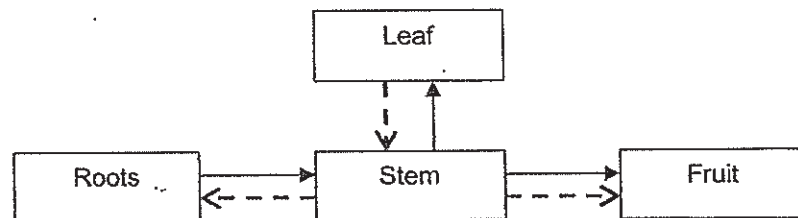

Which of the following correctly shows what the materials are?

	—————→	-----→
(1)	Glucose	Water
(2)	Water	Starch
(3)	Minerals	Water
(4)	Water	Glucose

12. At hospitals, instead of steps, the nurses use a ramp to help move patients on wheelchairs to go up and down different levels. The surface of the ramp is often textured like the one shown in the image.

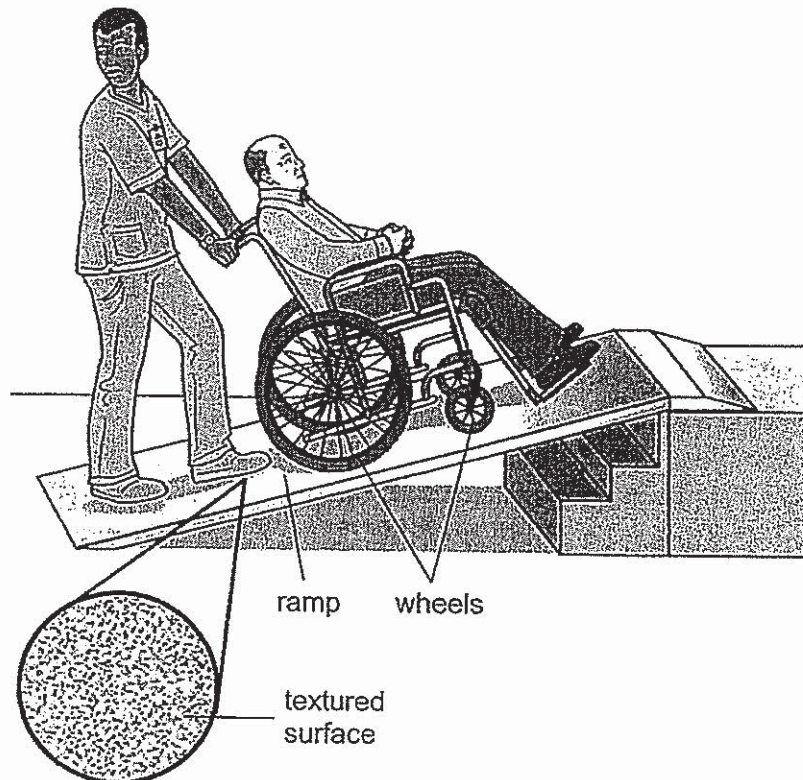

Which one of the following statements explains the reason for the textured surface of the ramp?

- (1) It reduces wear and tear to the wheels.
 - (2) It strengthens the ramp and prevents breakage.
 - (3) It increases friction between the wheels and the surface of the ramp.
 - (4) It increases friction between the patient and the wheelchair to prevent accidental fall.
13. Which of the following is/are not example(s) of the effects of a force?
- A The umbrella blocking the sunlight,
 - B A boy bouncing a ball against a wall.
 - C Mother sweeping the floor with a broom.
- (1) A only
 - (2) A and B only
 - (3) A and C only
 - (4) B and C only

14. Allan observed the organisms in the school aquarium.

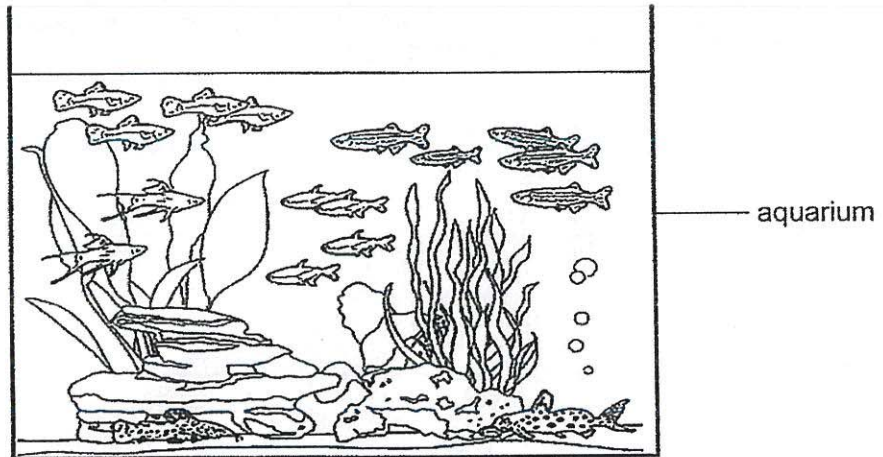

He wrote a few statements based on his observations.

- A The plants and fishes form a habitat.
- B The plants and fishes form two populations.
- C The fishes and the plants form one community.
- D The plants and fishes form more than two populations.

Which of the following two statements are correct?

- (1) B and C
- (2) B and D
- (3) C and D
- (4) A and C

15. The diagram shows part of the respiratory system of a fish.

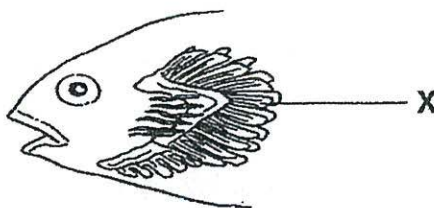

Which one of the following statements is **false** about X?

- (1) It is protected with a cover.
- (2) It has a rich supply of blood vessels.
- (3) It absorbs water containing dissolved oxygen.
- (4) It releases carbon dioxide that dissolves into the water.

16. Study the food web in Community A.

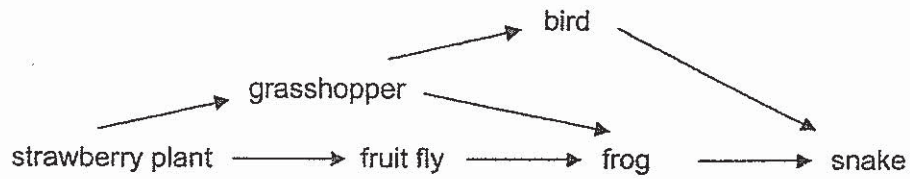

The graph shows the changes in the population of the frogs over a period of time.

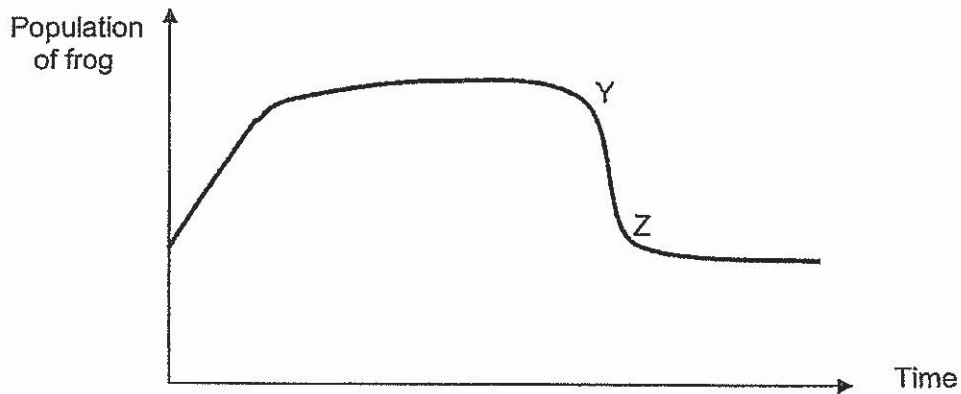

Which of the following best explains the change in the population of the frog at YZ in the graph?

- (1) Addition of grasshopper to the community
- (2) Addition of strawberry plant to the community
- (3) Removal of grasshopper from the community
- (4) Removal of fruit fly and grasshopper from the community

17. Harry observed two organisms, P and Q at the school pond.

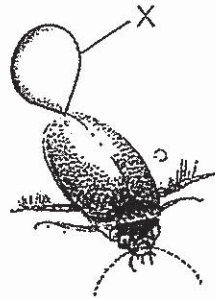

Organism P



Organism Q

Which one of the following correctly identifies how each organism breathes and where they are found at the pond?

Organism P		Organism Q	
X	Location at the pond	Y	Location at the pond
(1) air bag	just below the pond surface	blow hole	near the bottom of the pond
(2) air bubble	near the bottom of the pond	air tube	just below the pond surface
(3) air bag	above the pond surface	blow hole	above the pond surface
(4) air bubble	just below the pond surface	air tube	just below the pond surface

18. The table shows some information about three different cells, P, Q and R. A tick (✓) indicates that the part is present.

Parts of a cell	Cell P	Cell Q	Cell R
Cytoplasm	✓	✓	✓
Chloroplast		✓	
Cell wall		✓	✓

Based on the information given, which of the following statements describe(s) cells P, Q and R correctly?

- A Cell Q is a plant cell.
 B Cell P is able to make food.
 C Cell R may be taken from the root of a plant.
- (1) B only
 (2) A and C only
 (3) B and C only
 (4) A, B and C

19. Study the diagrams carefully.

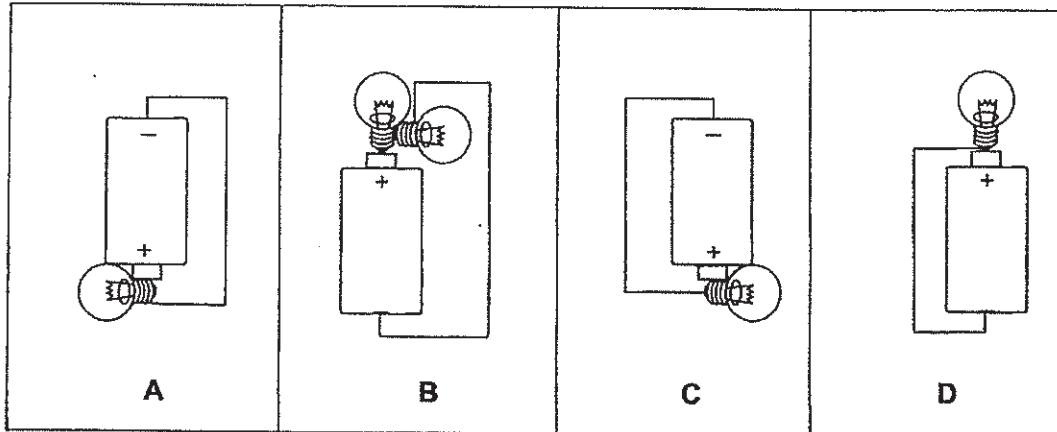

In which two circuits would the bulbs light up?

- (1) A and B
- (2) B and C
- (3) C and D
- (4) A and D

20. A beaker of ice was heated over a bunsen burner. The temperature of the contents in the beaker was taken and recorded over time. The results were plotted in the graph.

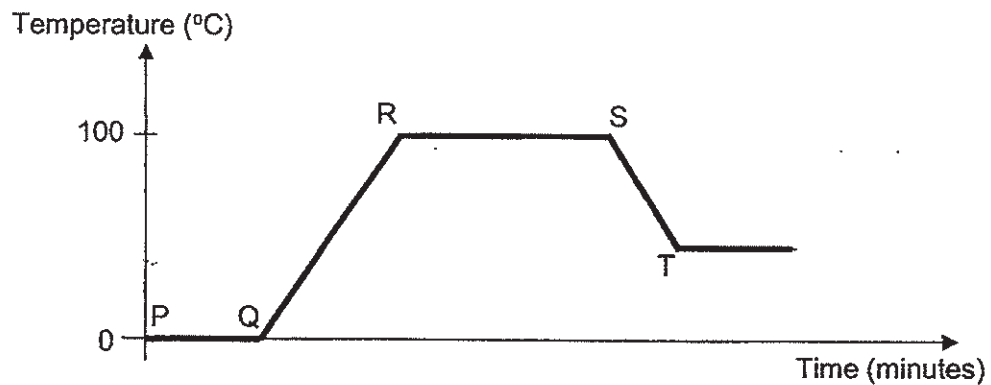

Which of the following two statements are true?

- | | |
|---|--|
| A | The bunsen burner was turned off at S. |
| B | There was no change of state from P to Q. |
| C | The temperature of the contents started to increase at Q. |
| D | There was no heat gained by the boiling water from R to S. |
- (1) A and B
 - (2) A and C
 - (3) B and D
 - (4) C and D

21. Calvin used a circuit tester in an experiment involving a circuit card. He connected Points X and Y of the circuit tester to various clips A, B, C, D, E and F on a circuit card to see if the bulb would light up.

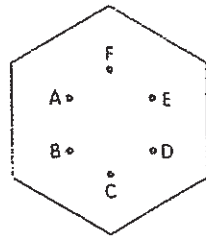

Circuit Card

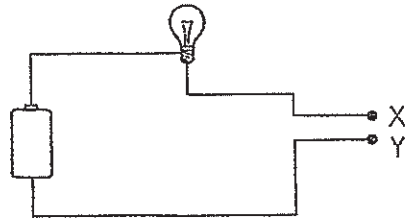

Circuit Tester

He recorded the results of his experiment in the following table :

Clips Tested	Bulb of Circuit Tester
A and B	Did not light up
A and F	Lit up
B and D	Did not light up
C and E	Did not light up
C and F	Lit up

Which of the following circuit cards did Calvin use in his experiment?

(1)

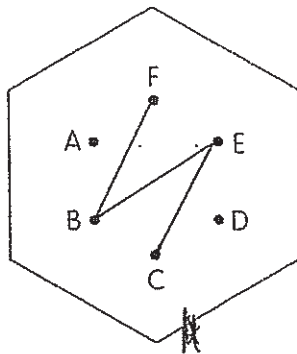

(2)

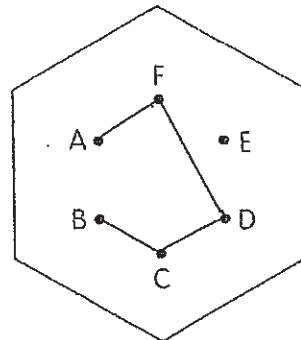

(3)

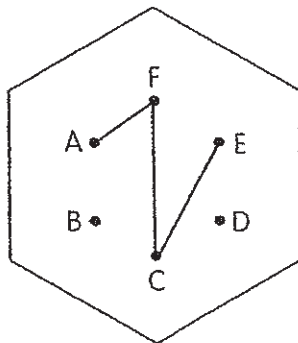

(4)

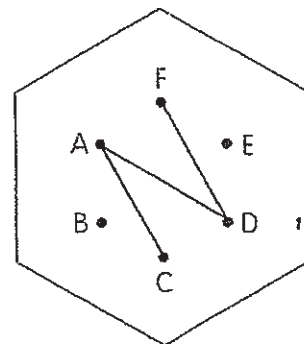

22. Sally wanted to study the shadows that could be formed by Object X. Object X was placed in two different positions directly under identical light sources in a dark room so that shadows were formed respectively on screens A and B as shown.

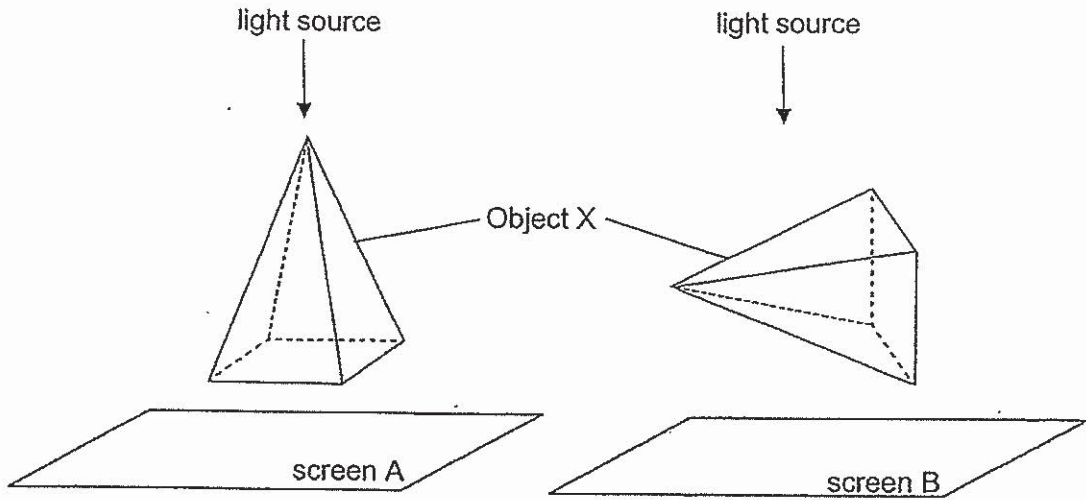

Which of the following shadows would be observed for each screen?

	Screen A	Screen B
(1)		
(2)		
(3)		
(4)		

23. Study the set-ups A and B.

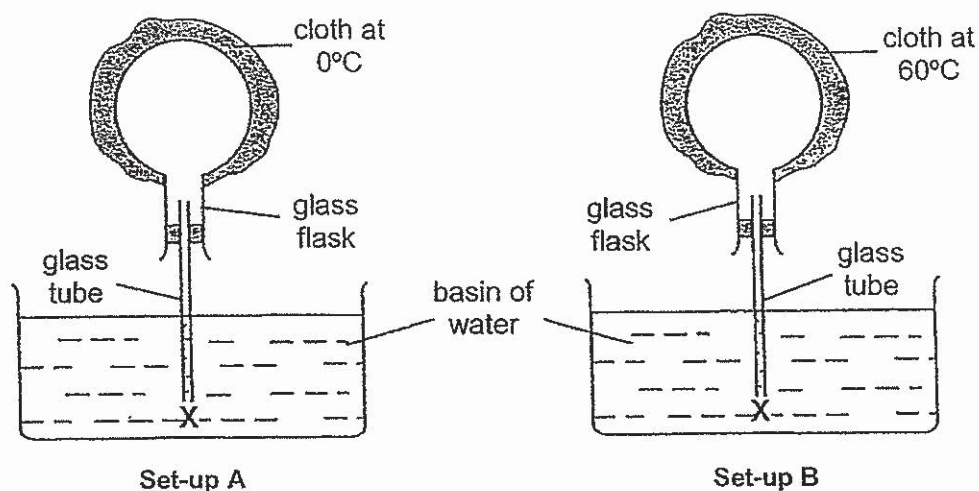

A cloth soaked in water at 0°C was placed on the glass flask A and another cloth soaked in water at 60°C was placed on the glass flask B. Which one of the following can be observed one minute after the cloths were placed on the glass flask A and B?

	Observation for Set-up A	Observation for Set-up B
(1)	Water rises up the glass tube	Water rises up the glass tube
(2)	Bubbles escape from the glass tube at X	Water rises up the glass tube
(3)	Water rises up the glass tube	Bubbles escape from the glass tube at X
(4)	Bubbles escape from the glass tube at X	Bubbles escape from the glass tube at X

24. Calvin drops a ball from P.

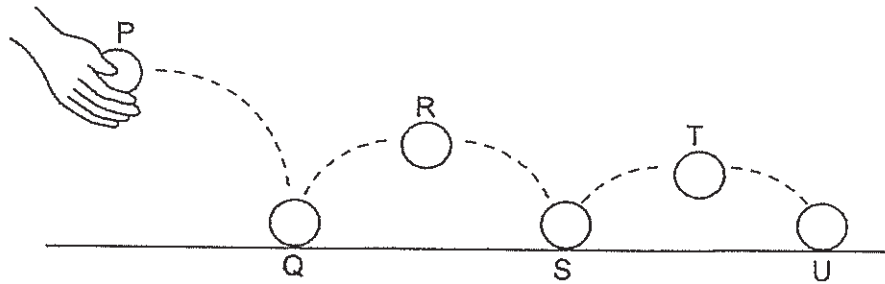

Which of the following statements are true?

- A The ball has the greatest amount of gravitational potential energy at P.
 - B The ball stops bouncing because some of its energy is changed to sound energy and heat energy.
 - C Kinetic energy is changed to gravitational potential energy when the ball moves from S to T.
 - D The ball never bounces back to the height it was released from because some of its kinetic energy is destroyed every time it hits the floor.
- (1) A and B only
(2) B and C only
(3) A, B and C only
(4) A, C and D only

25. Below is a concept map of process X.

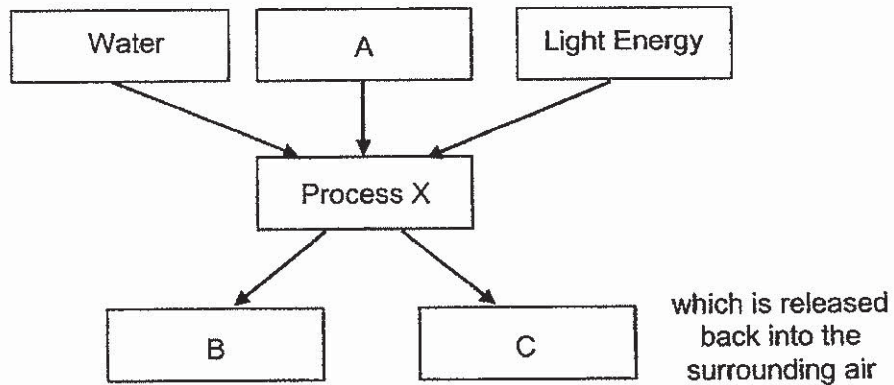

Which of the following correctly represents ~~process X and~~ substances A, B and C?

	A	B	C
(1)	Oxygen	Glucose	Carbon Dioxide
(2)	Oxygen	Starch	Carbon Dioxide
(3)	Carbon Dioxide	Glucose	Oxygen
(4)	Carbon Dioxide	Starch	Oxygen

26. Tom placed a healthy potted plant in a glass container and sealed it. He placed the glass container in the garden and measured the percentage of carbon dioxide in the container at regular intervals over a 24 hour time period. He plotted the results on the graph shown.

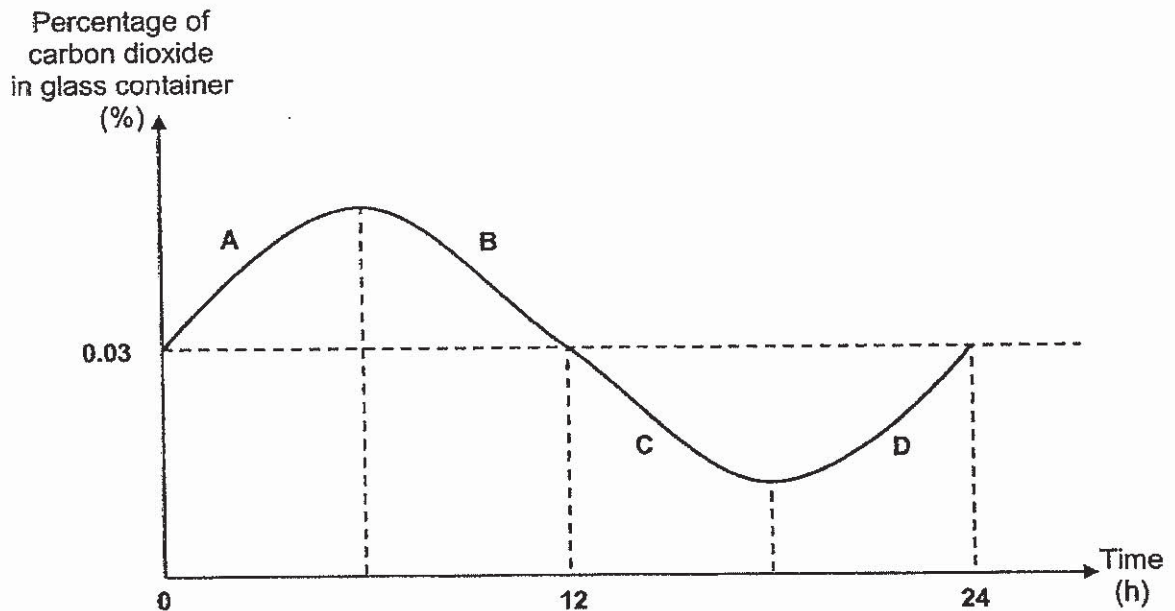

Which two parts of the graph show that photosynthesis was taking place?

- (1) A and B
- (2) B and C
- (3) C and D
- (4) A and D

27. Rowan placed a ball at the top of a ramp at position A as shown. When she released the ball, it rolled down the ramp from position A to position B and C.

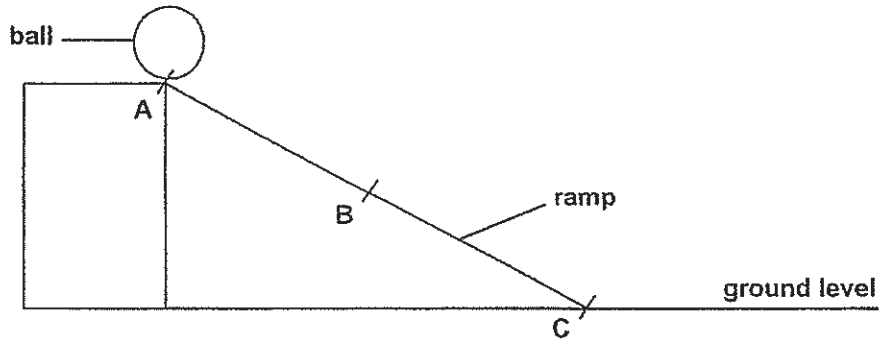

Which one of the following graphs correctly represents the change in the amount of gravitational potential energy and kinetic energy possessed by the ball as it rolled down the ramp from position B to C?

Key :

———— Gravitational Potential Energy

----- Kinetic Energy

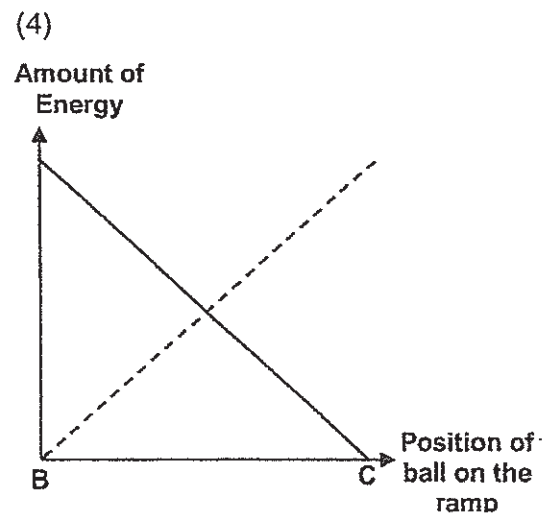
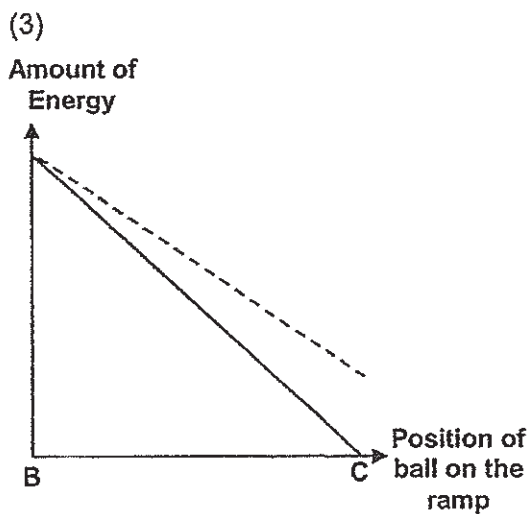
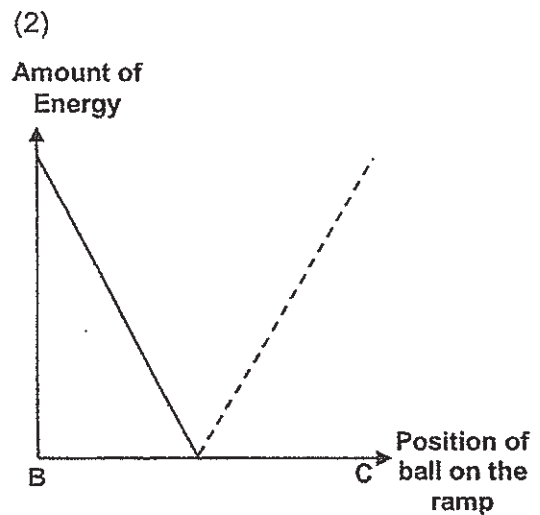
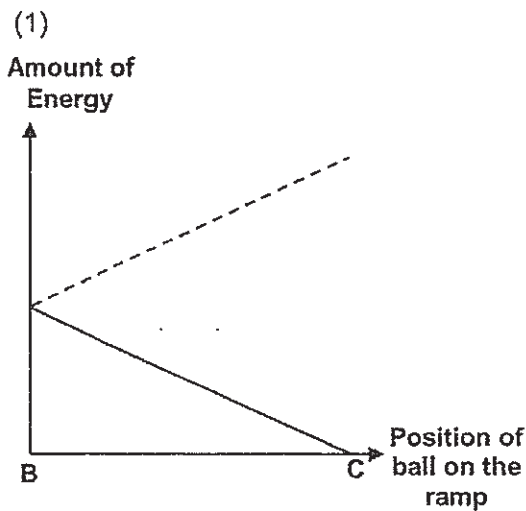

28. The diagram shows the human digestive system.

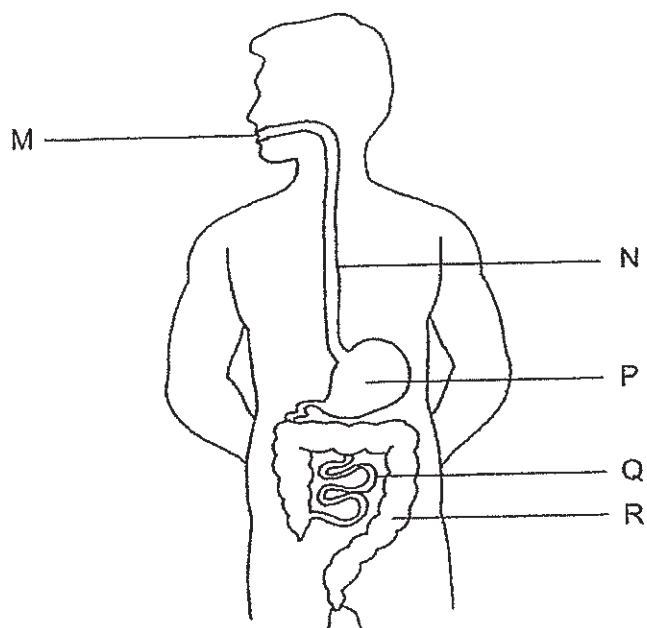

Which of the following correctly identifies the function(s) of M, N, P, Q and R?

	Produces digestive juices	Where digested food is absorbed and passed into the bloodstream	Removes water from undigested food
(1)	M, N, P	Q	Q, R
(2)	M, P, Q	Q	R
(3)	M, N, Q	Q, R	Q, R
(4)	M, P, Q	P, Q	R

End of Booklet A

Anglo-Chinese School (Junior)



SEMESTRAL ASSESSMENT 1 (2019)

PRIMARY 6

SCIENCE

BOOKLET B

Friday

17 May 2019

1 hr 45 min

Name: _____ () Class: 6.() Parent's Signature: _____

INSTRUCTIONS TO PUPILS

- 1 Do not turn over the pages until you are told to do so.
- 2 Follow all instructions carefully.
- 3 There are 13 questions in this booklet.
- 4 Answer ALL questions.
- 5 The marks are given in the brackets [] at the end of each question or part question.

Booklet	Possible Marks	Marks Obtained
A	56	
B	44	
Total	100	

This question paper consists of 14 printed pages (inclusive of cover page).

Booklet B

For questions 29 to 41, write your answers in this booklet.

The number of marks available is shown in brackets [] at the end of each question or part question.

[44 marks]

- 29 The diagram shows the blood vessels, P, Q, R, S, T and U between different systems and parts of a human body.

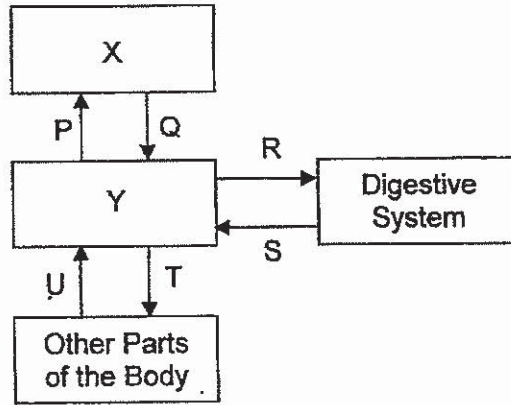

- (a) Identify X and Y.

[1]

X : _____

Y : _____

- (b) In which blood vessel(s), P, Q, R, S, T or U is the blood rich in oxygen? Explain why.

[1]

- (c) Name two useful substances that are present in the blood in S that are provided only by the digestive system.

[1]

(Go on to the next page)

SCORE	3
-------	---

30 The diagrams show two possible ways in which electric bulbs in three different rooms can be connected to the electrical power supply.

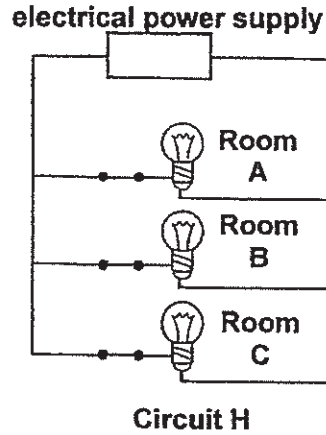
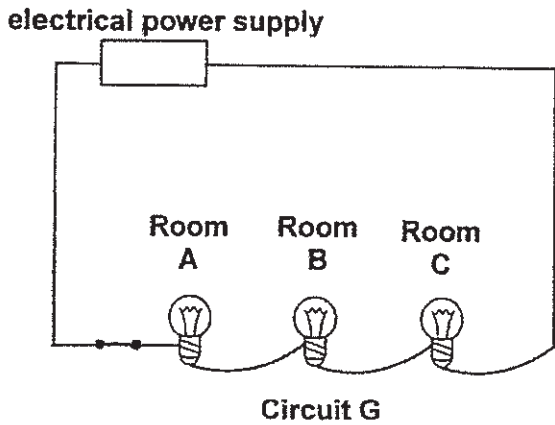

(a) Identify the arrangement of bulbs in the circuits. [1]

Circuit G : _____

Circuit H : _____

(b) Compare Circuit G and Circuit H. Explain clearly what are two advantages that Circuit H has over Circuit G. [2]

Advantage 1 :

Advantage 2 :

(c) Mark an "X" on the diagram to indicate the position of a switch such that when it is open, only the bulb in Room A remains lit. [1]

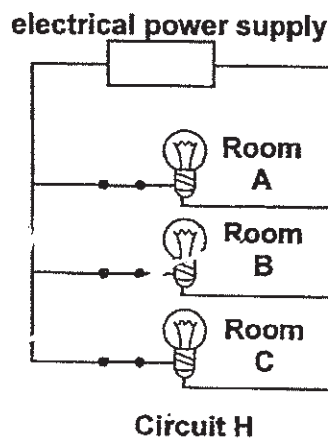

(Go on to the next page)

SCORE	4
-------	---

- 31 Tom set up an experiment as shown. Identical thermometers, rubber stoppers and metal containers were used in Set-up P and Set-up Q, with an equal volume of cold water at 5°C added to both set-ups. The metal containers in each set-up were wrapped around with Material X and Material Y respectively.

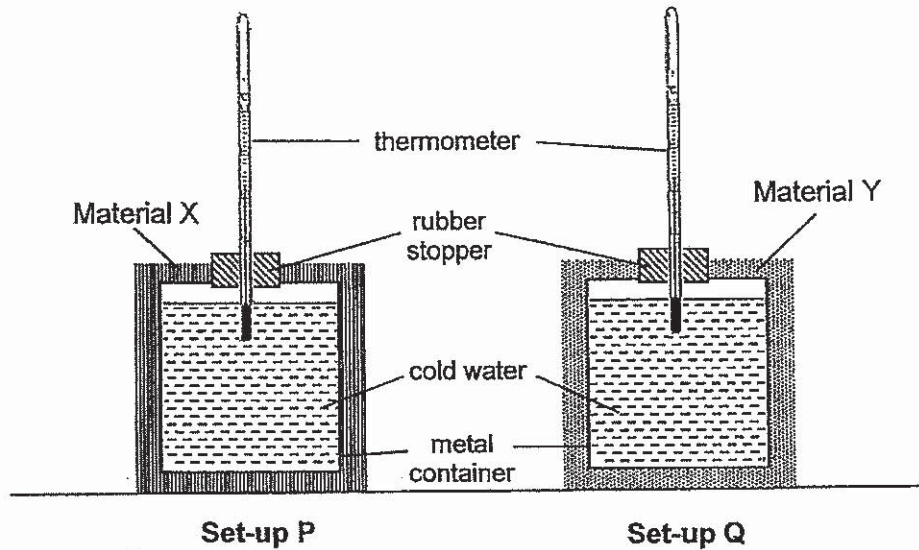

Tom recorded the temperature of the water in Set-up P and Set-up Q over 6 hours in the graph.

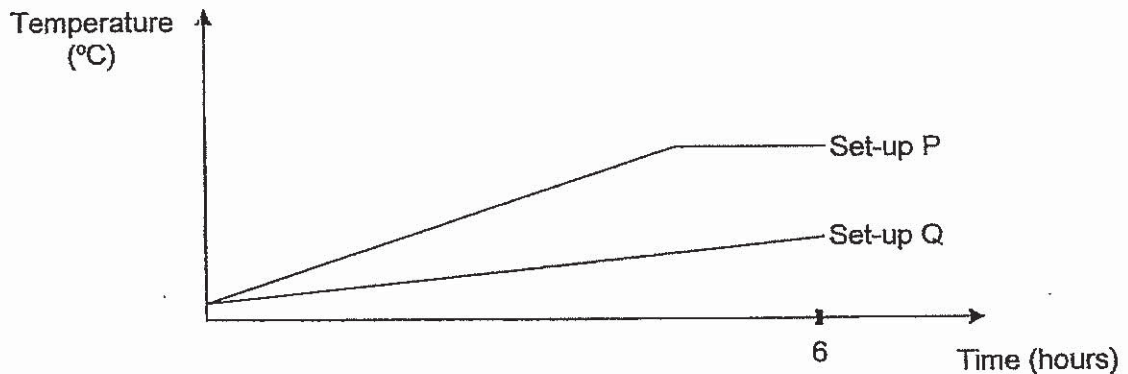

- (a) Using the results of the experiment shown ⁱⁿ the graph, compare the heat gain between the water in Set-up P and Set-up Q. [1]

- (b) Based on the results of the experiment, which material, X or Y, should Tom use to make a box which can keep ice-cream from melting for the longest time? Explain your answer clearly. [1]

(Go on to the next page)

SCORE	2
-------	---

- (c) State another variable that should be kept constant. Explain clearly how this ensures that the experiment is a fair test. [2]

- 32 Jack set up an experiment as shown in the diagram. He pulled the plunger of the toy launcher back (distance X). When he released the plunger, it moved forward and hit the metal ball so that the ball rolled a distance away. He measured the distance travelled by the ball (distance D).

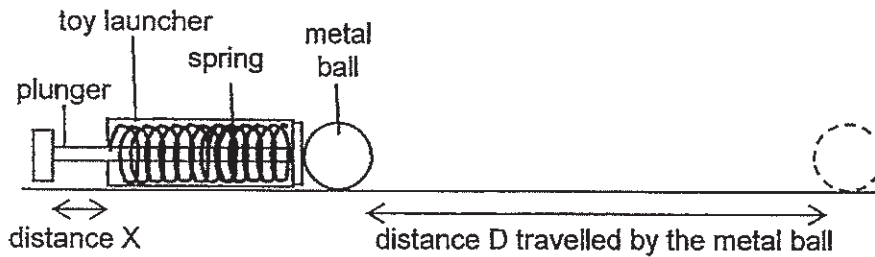

Jack repeated the experiment by pulling the plunger back to different distances each time before releasing it, and measured the distance travelled by the metal ball. He recorded the results in the table.

Distance the plunger was pulled back (Distance X) (cm)	Distance travelled by the metal ball (Distance D) (cm)
1	6
2	12
3	18
4	24

- (a) State the relationship between the distance the plunger was pulled back and the distance travelled by the metal ball. [1]

- (b) Fill in the blanks to show the correct energy conversions that occur when Jack pulls the handle of the toy back and then releases it. [1]

_____ energy → _____ energy + _____ energy + _____ energy
 (in the compressed spring) (in the moving metal ball)

(Go on to the next page)

SCORE	4
-------	---

Jack then modified his earlier experiment by putting a ramp in front of the metal ball.

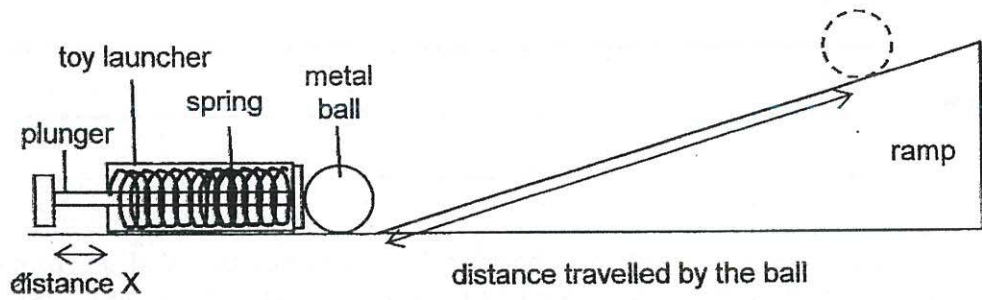

- (c) If Jack pulls the handle of the toy back by 1 cm and releases it, will the distance travelled by the metal ball up the ramp be greater or less than 6 cm? Explain the reason for your answer in energy terms. [1]

33 The table compares the amount of certain gases in inhaled air and exhaled air in the human respiratory system.

- (a) Fill in the words "More", "Less" or "Same" in the boxes to complete the table. [1]

S/N	Amount of Gas	Inhaled Air	Exhaled Air
1	Oxygen		
2	Carbon Dioxide		
3	Nitrogen		

- (b) What is the use of oxygen in the human body? Explain clearly. [1]

- (c) Does inhaled air or exhaled air contain less dust? Explain the reason for your answer. [1]

(Go on to the next page)

SCORE	4
-------	---

34 The diagrams show two power stations that generate electricity.

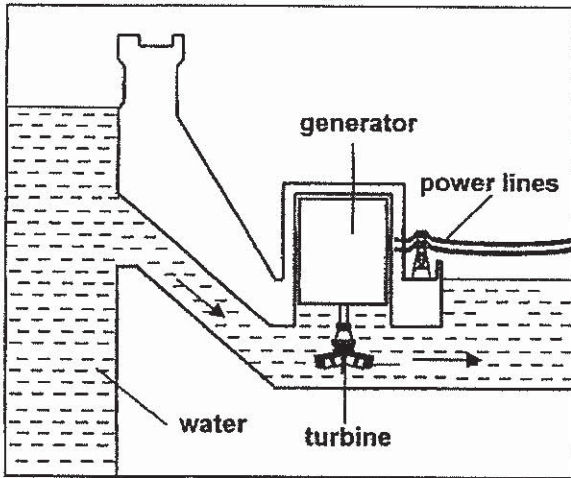

Power Station R

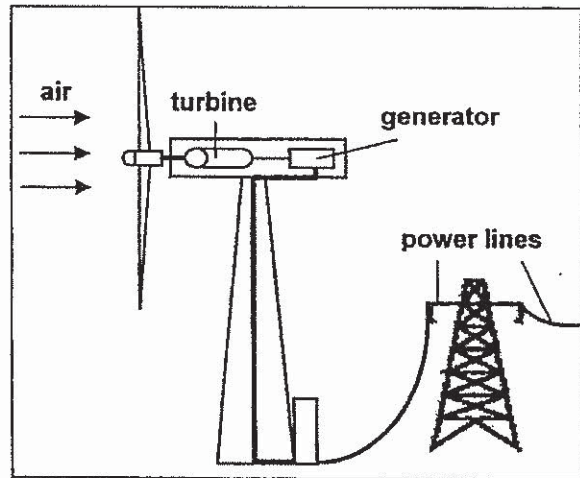

Power Station S

(a) What is the source of energy that Power Stations R and S use to generate electricity? [1]

(i) Power Station R - _____

(ii) Power Station S - _____

(b) State two advantages of using the source(s) of energy in (a) to generate electricity, as compared to a power station that uses fossil fuels to generate electricity. [1]

(i) Advantage 1 :

(ii) Advantage 2 :

(c) State two disadvantages of using S to generate electricity, as compared to using a power station that uses fossil fuels to generate electricity. [1]

(i) Disadvantage 1 :

(ii) Disadvantage 2 :

(Go on to the next page)

SCORE	
	3

- 35 The diagram shows a stage in the life cycle of a plant.



- (a) George decided to place the plant at this stage in a dark cupboard for two weeks. He watered it regularly. Explain clearly what happened to the plant during the two weeks. [2]

- (b) George noticed that many insects and small birds are attracted to the adult plant in his garden. How do these organisms help the plant reproduce? Explain your answer. [1]

(Go on to the next page)

SCORE	
	3

36 The diagrams show the life cycle of a frog and a cockroach.

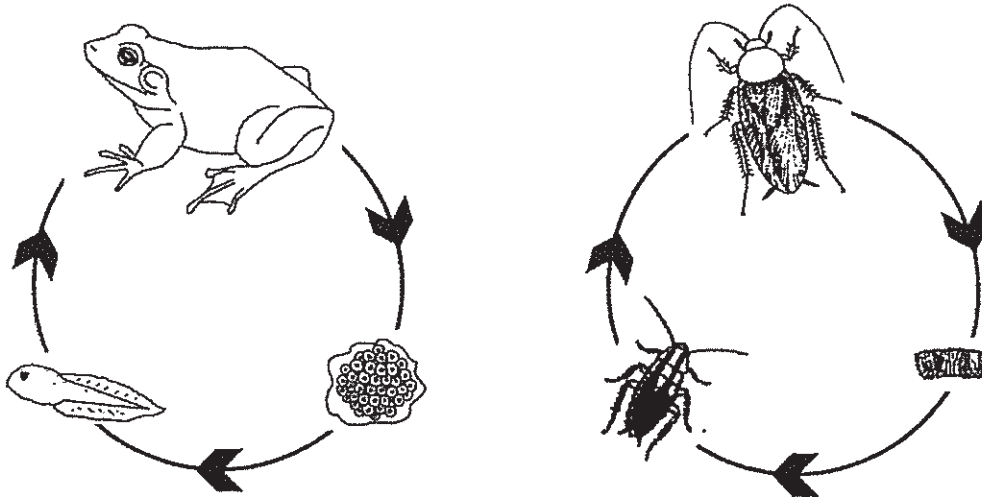

(a) State two differences between the two life cycles.

[2]

- (i) _____

- (ii) _____

(b) Diana studies the effect of surrounding temperature on the life cycles of both organisms. Her findings are shown in the table.

Temperature (°C)	Number of weeks for one complete life cycle
	Cockroach
15	10
20	8
25	7
30	4
35	4

From Diana's findings, state the relationship between temperature and the number of weeks for one complete life cycle of the cockroach.

[1]

(Go on to the next page)

SCORE	3
-------	---

37 Study the diagram carefully.

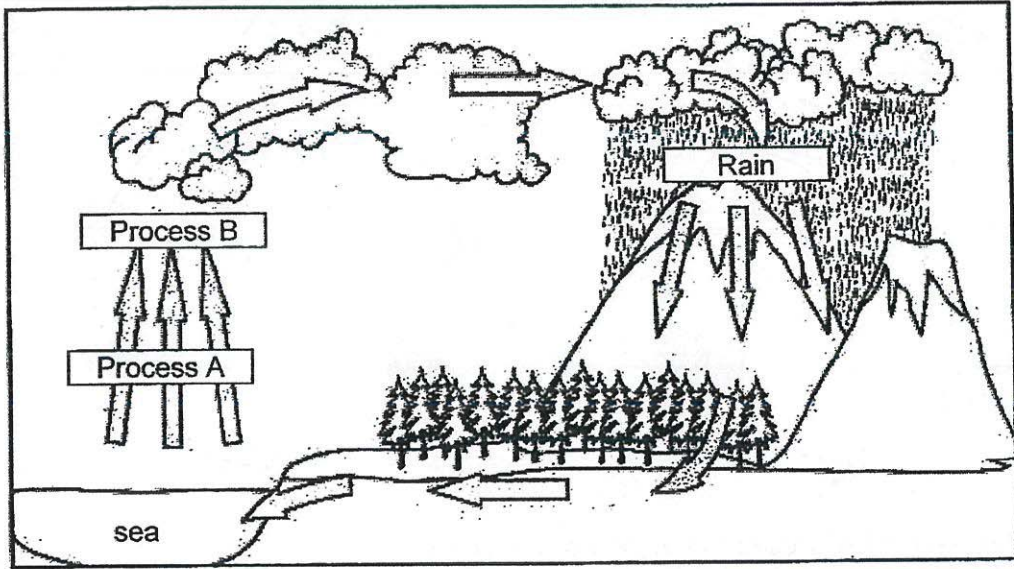

(a) Describe Processes A and B. [1]

Process A : _____

Process B : _____

Mr Tan put up the following set up in the classroom to show Processes A and B to his students.

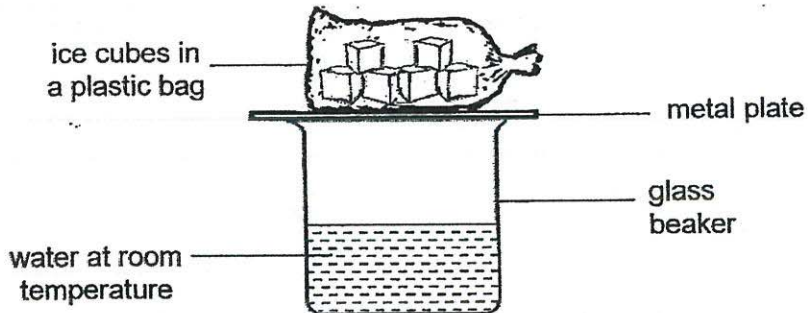

(b) After a few minutes, Mr Tan and his students observed that there were water droplets on the underside of the metal plate. What had caused the water droplets to form there? Explain your answer clearly. [2]

(Go on to the next page)

SCORE	3

38 Study Bird W. It is adapted to live in very cold temperatures and feeds on fish.

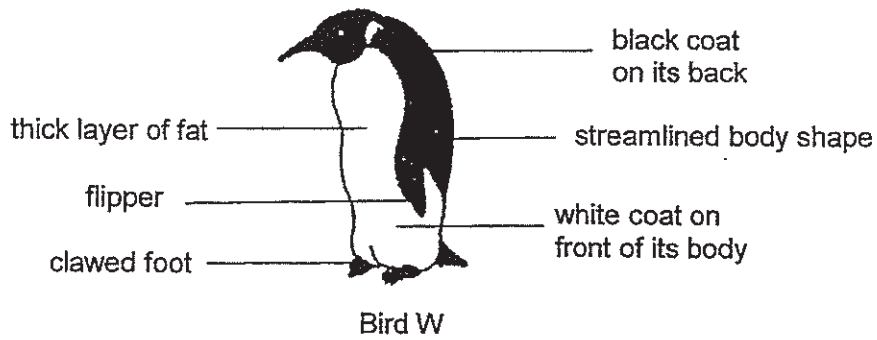

(a) Which structural adaptation of Bird W helps to survive in such cold temperatures? Explain how. [1]

(b) Since Bird W feeds primarily on fish, state two adaptations that enable it to catch fish effectively. Write your answer in the boxes provided. [2]

Adaptation	How the adaptation helps Bird W feed on fish

(c) In Antarctica, where it is covered with ice and snow, Bird W huddles together with others of its own kind to stay warm in the icy winds.

How does this behavioural adaptation help Bird W to survive in such an extreme environment? Explain your answer clearly. [1]

(Go on to the next page)

SCORE	4
-------	---

39 The diagram shows a food web.

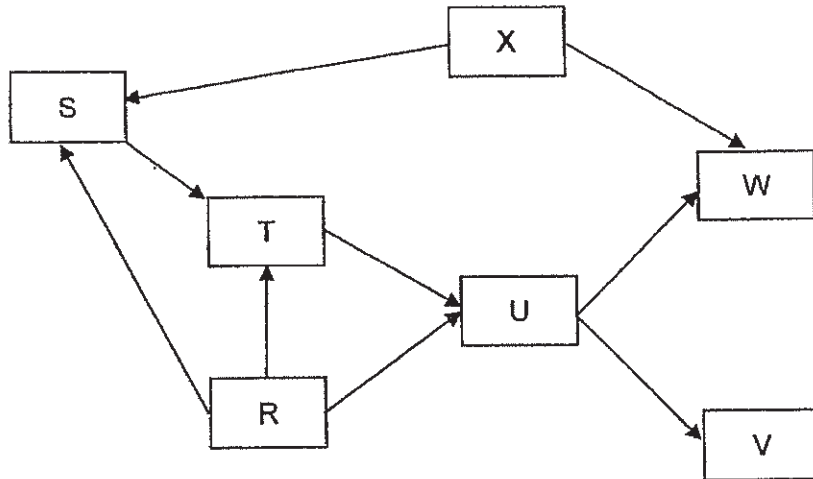

(a) Identify the following organisms : [2]

- (i) Food producer(s) : _____
- (ii) Animal-eater(s) : _____
- (iii) Plant and animal-eater(s) : _____
- (iv) Both prey and predator : _____

(b) After two weeks, it was observed that the population of S had increased. State two possible reasons why this could have happened. [2]

(c) V is a predator and it also feeds on the chickens and ducks which live in the nearby village from time to time. The villagers set up traps to catch and kill them to prevent them from feeding on their chickens and ducks. Which population will be most affected by this? Explain your answer. [1]

(Go on to the next page)

SCORE	5
-------	---

- 40 Charles set up an experiment in the science laboratory as shown. He released the toy car from point A and measures the distance that the car has travelled.

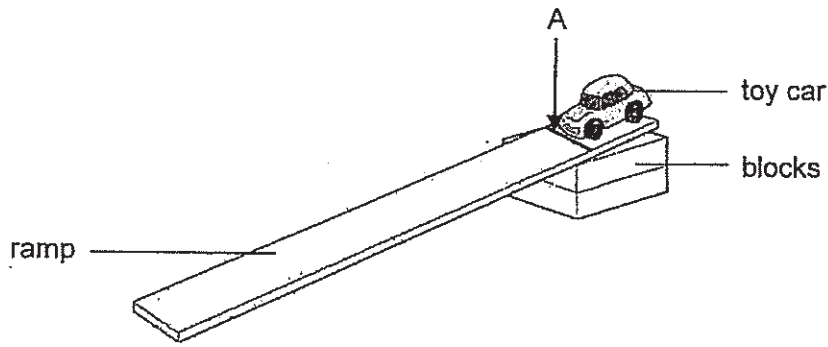

- (a) What force(s) is/are acting on the car as it travels down the ramp? [1]

- (b) Without changing any of the items in the experiment, what can Charles do to make the car travel down the ramp faster? Explain your answer clearly. [1]

Charles repeated the experiment by changing the toy car to a bigger and heavier toy truck. The distance travelled by the two toy vehicles are shown in the graph.

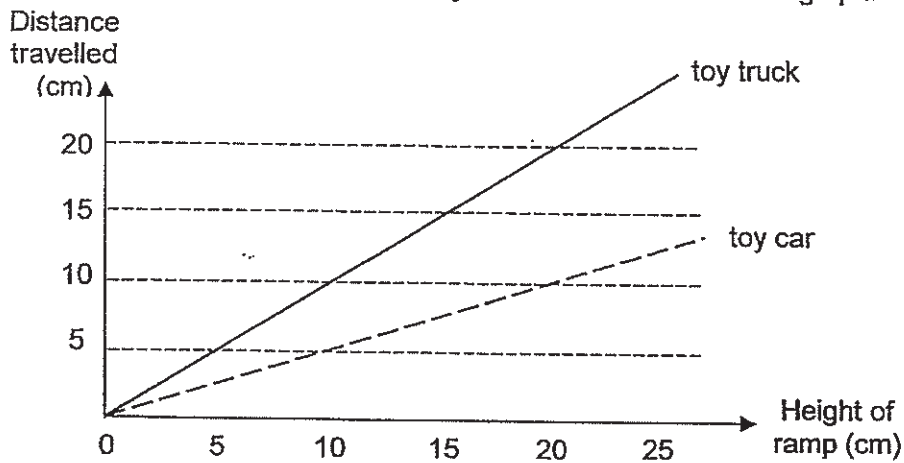

- (c) What can be concluded from the results? [1]

(Go on to the next page)

SCORE	3
-------	---

- 41 There was a leakage of harmful chemical from a nearby factory into the River Nole, causing fishes to die. When it was discovered, the government closed down the factory. The graph shows the number of fishes in the river over a year.

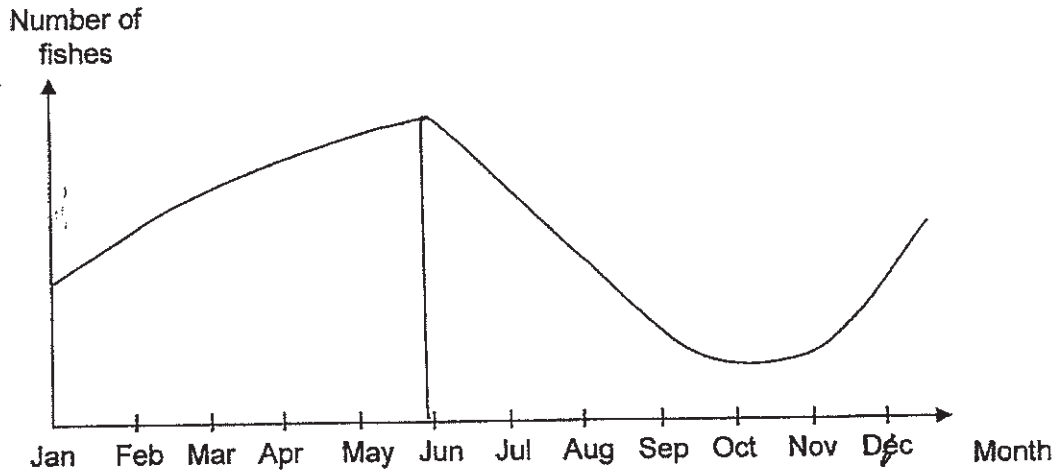

- (a) State the months that show when the leakage had started and when the conditions of the river was once again suitable for the fishes to thrive. [1]

Activity	Month
Leakage began	
Fishes start to reproduce	

- (b) On the diagram, mark with the letter 'X' to show the most likely location on the river where the dead fishes were found. [1]

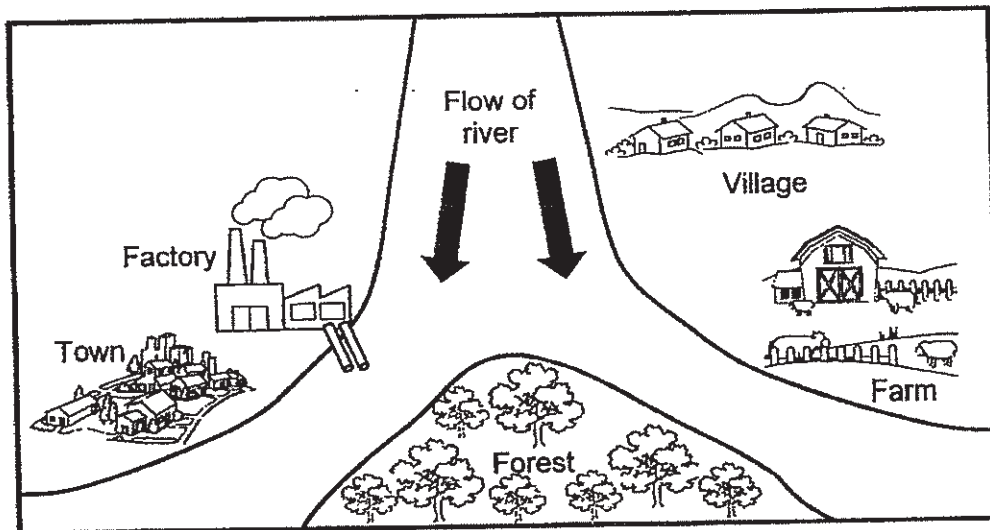

- (c) In some countries, factories dump waste materials into the rivers. Other than the reasons stated in (a), state one other effect of this activity on the local environment as shown in the diagram. [1]

End of Paper

SCORE	3

EXAM PAPER 2019

LEVEL : PRIMARY 6
SCHOOL : ANGLO-CHINESE SCHOOL (JUNIOR)
SUBJECT : SCIENCE
TERM : SA1
BOOKLET A

Q1	Q2	Q3	Q4	Q5	Q6	Q7	Q8	Q9	Q10
3	4	1	1	4	1	4	2	2	2
Q11	Q12	Q13	Q14	Q15	Q16	Q17	Q18	Q19	Q20
4	3	1	3	3	4	2	2	2	2
Q21	Q22	Q23	Q24	Q25	Q26	Q27	Q28		
4	3	3	3	3	1	1	2		

BOOKLET B

- Q29. (a) X : lungs
Y : heart
- (b) Q, R and T. The blood has just returned from the lungs where oxygen was taken in and carbon dioxide was given out.
- (c) Water and digested food.

- Q30. (a) Circuit G : series
Circuit H : parallel
- (b) In H, when one bulb fuses, the other bulbs will still light up.
Bulbs in H will be brighter.

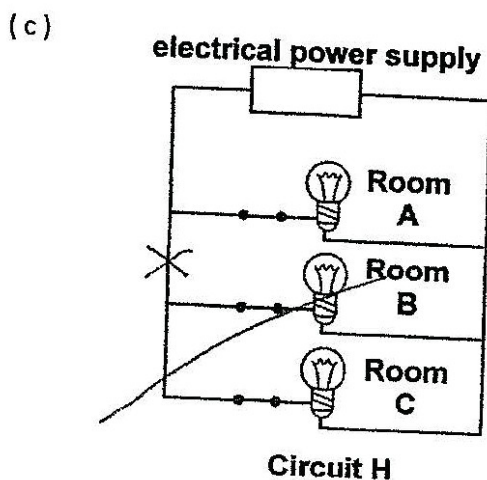

- Q 31. (a) The water in set-up P gains more heat than the water in set-up Q.
- (b) Material Y. As in set-up Q, the water took a longer time to reach room temperature, hence Y is not a good conductor of heat.
- (c) The materials must have the same thickness as it will take a longer time for the water to gain heat if it is thicker. This will affect the reliability of the results of the experiment.
- Q32. (a) The longer the plunger was pulled back, the longer the distance travelled by the metal ball.
- (b) elastic potential energy \rightarrow kinetic energy + heat energy + sound energy
- (c) Some of the kinetic energy of the metal ball was converted to gravitational potential energy.
- Q33. (a) 1) more, less
2) less, more
3) same, same
- (b) It is used to release energy during respiration.
- (c) Exhaled air. If you inhale, you will inhale more dust.
- Q34. (a) (i) moving water
(ii) wind
- (b) (i) Does not cause air pollution.
(ii) It is renewable energy.
- (c) (i) A lot more space is needed for S.
(ii) There may not be enough wind all the time to generate electricity.
- Q35. (a) It will die as the stored food in the seed leaves would have used up and there was no sunlight for the leaves to make food.
- (b) The birds will eat the fruit together with the seed and can disperse the seed. The insects help with the pollination of the plants.
- Q36. (a) (i) The young of the cockroach looks like the adult but the young of the frog does not.
(ii) The frog lays its eggs in the water, however the cockroach does not lay its eggs in the water.

- (b) The higher the temperature, the lesser the number of weeks taken for the cockroach take to complete one life cycle, until 30°C.

Q37. (a) Process A : The water in the sea gains heat and evaporates into water vapour.
Process B : The water vapour loses heat and condense into tiny water droplets to form clouds.

- (b) Water evaporated into water vapour which touched the cooler underside of the metal plate and condensed onto tiny water droplets on it.

Q38. (a) Bird W has a thick layer of fat to stop its body from losing heat.

(b)

Adaptation	How the adaptation helps Bird W feed on fish
Streamlined body shape	To swim fast in the water to catch fish
Flippers	Helps it to swim

- (c) It enables the penguins to share body heat from other penguins.

Q39. (a) (i) Food producer(s) : R, X
(ii) Animal-eaters(s) : v
(iii) Plant and animal-eater(s) : T, U, W
(iv) T

- (b) The population of T decrease and the population of X and R increase.

- (c) U. Its population will increase as there are fewer V as they are a source of food for them.

Q40. (a) Gravitational force and frictional force .

- (b) Apply a lubricant to in the ramp to reduce friction between the toy car and the surface of the ramp.

- (c) The heavier the car, the longer it travels.



(c) The heavier the car, the longer it travels.

Q41. (a) June, November.

(b)

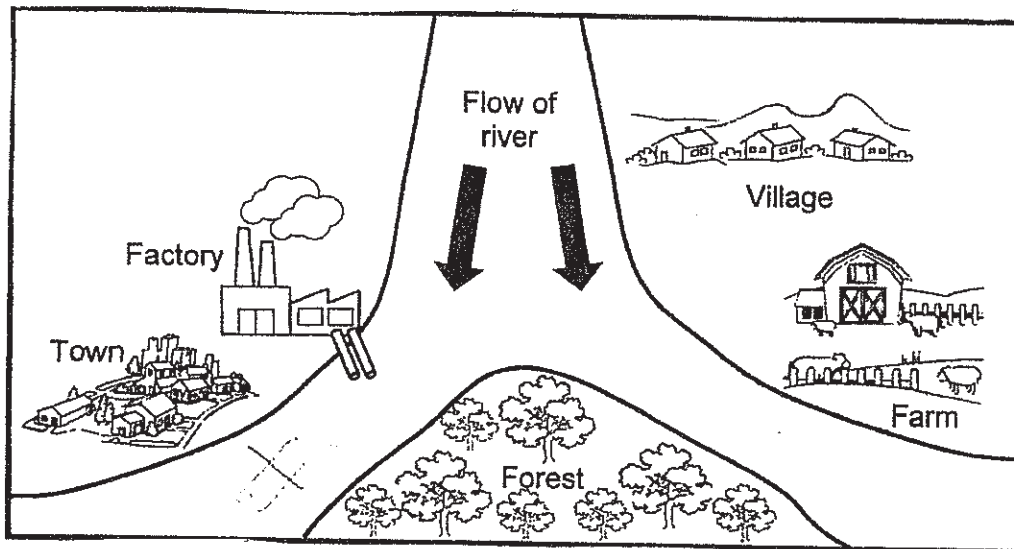

(c) The water supply to the town will be polluted.

THE END