



MARIS STELLA HIGH SCHOOL (PRIMARY)
PRELIMINARY EXAMINATION
PRIMARY 6 MATHEMATICS
16 AUGUST 2024
PAPER 1
(BOOKLET A)

15 questions

20 marks

Total time for Booklets A and B: 1 hour

NAME : _____ ()

CLASS : PRIMARY 6 _____

INSTRUCTIONS TO CANDIDATES

1. DO NOT OPEN THIS BOOKLET UNTIL YOU ARE TOLD TO DO SO.
2. FOLLOW ALL INSTRUCTIONS CAREFULLY.
3. ANSWER ALL QUESTIONS.
4. SHADE YOUR ANSWERS IN THE OPTICAL ANSWER SHEET (OAS) PROVIDED.
5. YOU ARE NOT ALLOWED TO USE A CALCULATOR.

Questions 1 to 10 carry 1 mark each. Questions 11 to 15 carry 2 marks each.
For each question, four options are given. One of them is the correct answer.
Make your choice (1, 2, 3 or 4) and shade your answer on the Optical Answer Sheet.

(20 marks)

1 In which of the following numbers does the digit 5 appear in the ten thousands place?

- (1) 567 891
- (2) 987 654
- (3) 1 234 567
- (4) 7 654 321

2 Which of the following fractions is equal to $5\frac{6}{7}$?

- (1) $\frac{30}{7}$
- (2) $\frac{35}{7}$
- (3) $\frac{37}{7}$
- (4) $\frac{41}{7}$

3 What is the likely length of a public bus?

- (1) 1.2 cm
- (2) 12 m
- (3) 120 m
- (4) 1.2 km



4 Round 3.456 to 2 decimal places.

- (1) 3.40
- (2) 3.45
- (3) 3.46
- (4) 3.50

- 5 The diagram below (not drawn to scale) shows the length of a pencil.

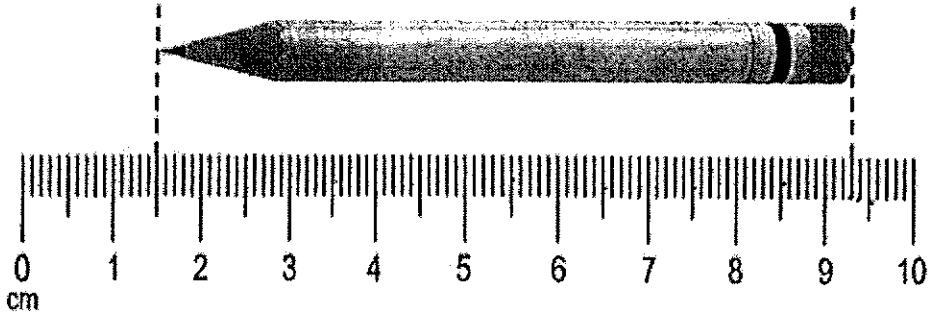

What is the length of the pencil?

- (1) 1.5 cm
 (2) 7.8 cm
 (3) 8.2 cm
 (4) 9.3 cm
- 6 Arrange the following lengths from the shortest to the longest.

10 m 50 cm 10 500 cm 10.05 m

- | | shortest | | longest |
|-----|-------------|-------------|------------|
| (1) | 10.05 m, | 10 m 50 cm, | 10 500 cm |
| (2) | 10 m 50 cm, | 10.05 m, | 10 500 cm |
| (3) | 10 500 cm, | 10 m 50 cm, | 10.05 m |
| (4) | 10 500 cm, | 10.05 m, | 10 m 50 cm |

- 7 The figure below is made up of identical triangles. What percentage of the figure is shaded?

- (1) 10%
 (2) 15%
 (3) 40%
 (4) 60%

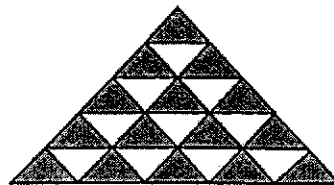

- 8 In the diagram below. AB, CD and EF are straight lines. AB is parallel to CD. Which of the following is **false**?

- (1) $\angle p + \angle q = 180^\circ$
- (2) $\angle q = \angle r$
- (3) $\angle p = \angle s$
- (4) $\angle q + \angle s = 180^\circ$

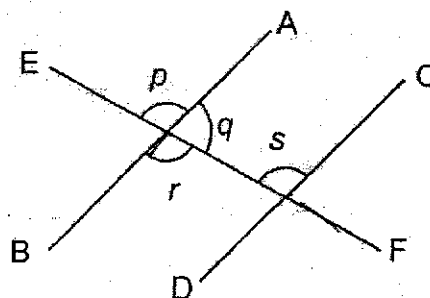

Study the pie chart below and answer questions 9 and 10.

The pie chart shows the choice of favourite colours of a group of students.

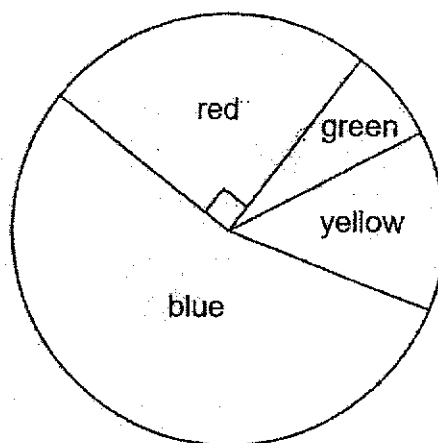

- 9 Which is the least favourite colour?

- (1) red
- (2) blue
- (3) green
- (4) yellow

10 Which bar graph correctly shows the choices of the students' favourite colour?

(1) Number of students

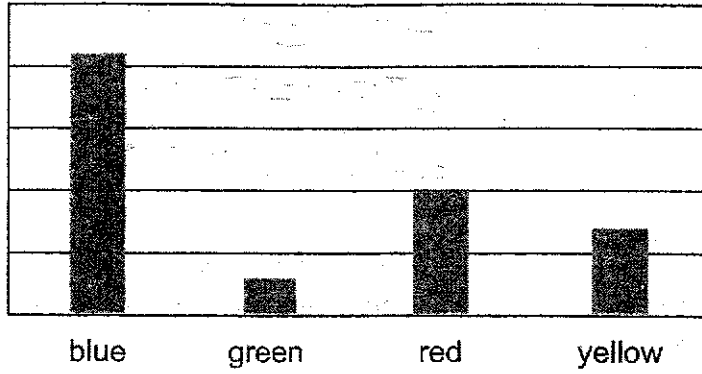

(2) Number of students

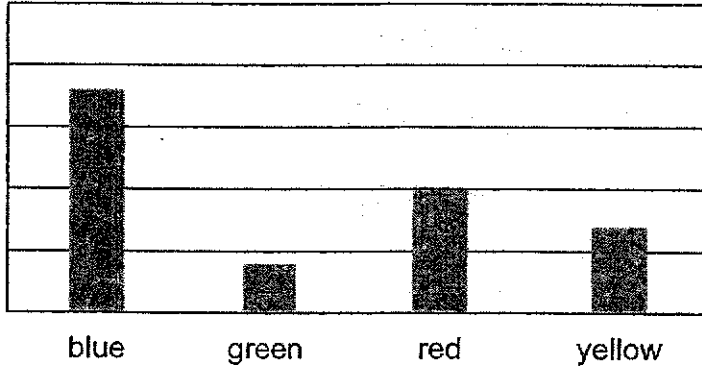

(3) Number of students

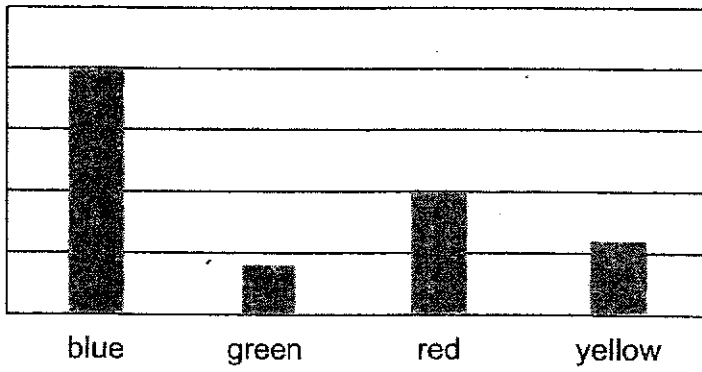

(4) Number of students

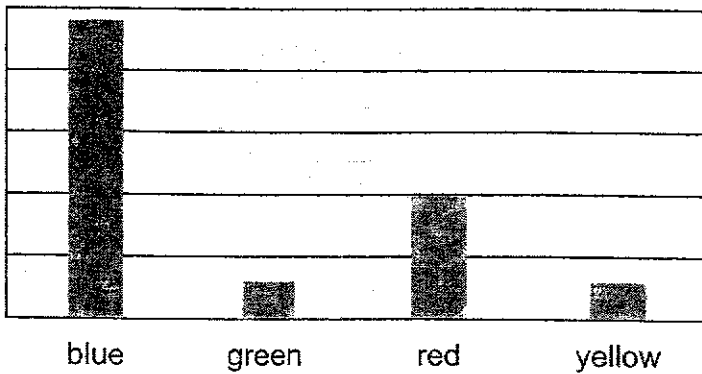

11 Which of the following expressions is the greatest?

- (1) $4 + 3 \times 2 - 1$
- (2) $4 + 3 \times (2 - 1)$
- (3) $(4 + 3) \times 2 - 1$
- (4) $(4 + 3 \times 2) - 1$

12 There were 60 blue chairs and 60 red chairs in the hall. More red chairs were added in the hall and the percentage of red chairs increased to 60%. How many red chairs were there in the hall in the end?

- (1) 66
- (2) 90
- (3) 96
- (4) 150

13 The figure below is made up of a square and 4 identical semicircles. The perimeter of the figure is 16π cm.

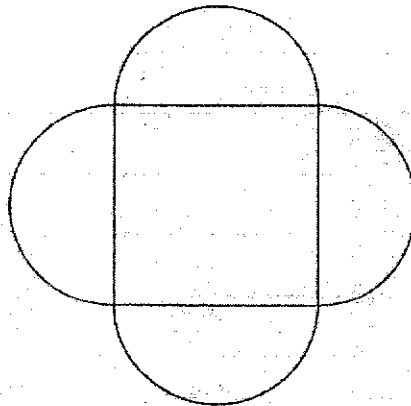

What is the perimeter of the square?

- (1) 8 cm
- (2) 16 cm
- (3) 32 cm
- (4) 64 cm

- 14 The pattern below is made up of the letters H, M, P and S.

M S H S P M S H S P M S ...
 1st 12th

Which letter is in the 123rd position?

- (1) H
 (2) M
 (3) P
 (4) S
- 15 The shapes below are drawn on square grids.

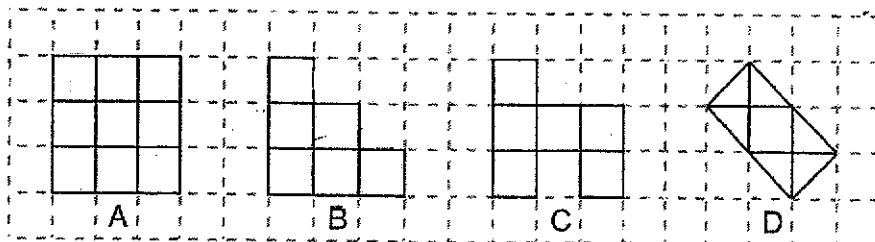

Which of the following statements is true?

- (1) A and B have the same perimeter.
 (2) A and B have the same area.
 (3) C and D have the same area.
 (4) C has a larger area than B.

END OF BOOKLET A
 GO TO BOOKLET B



MARIS STELLA HIGH SCHOOL (PRIMARY)
PRELIMINARY EXAMINATION
PRIMARY 6 MATHEMATICS
16 AUGUST 2024
PAPER 1
(BOOKLET B)

15 questions

25 marks

Total time for Booklets A and B: 1 hour

<p>NAME : _____ ()</p> <p>CLASS : PRIMARY 6 _____</p>
--

INSTRUCTIONS TO CANDIDATES

1. DO NOT OPEN THIS BOOKLET UNTIL YOU ARE TOLD TO DO SO.
2. FOLLOW ALL INSTRUCTIONS CAREFULLY.
3. ANSWER ALL QUESTIONS.
4. WRITE YOUR ANSWERS IN THIS BOOKLET.
5. YOU ARE NOT ALLOWED TO USE A CALCULATOR.

MARKS OBTAINED FOR		
PAPER 1 (BOOKLET A)	/ 20	Parent's Signature: _____ Date: _____
PAPER 1 (BOOKLET B)	/ 25	
TOTAL	/ 45	

Questions 16 to 20 carry 1 mark each. Write your answers in the spaces provided. For questions which require units, give your answers in the units stated. (5 marks)

Do not write in this space.

16 Write five million, fifty thousand and fifty in numerals.

Ans: _____

17 Find the area of the right-angled triangle below.

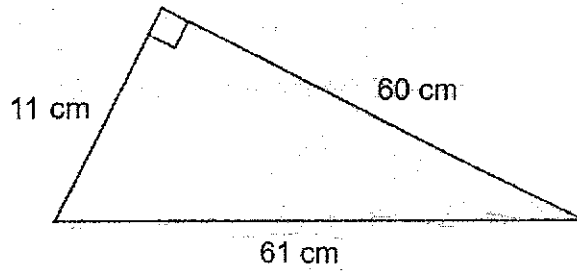

Ans: _____ cm²

18 Find $\angle p$.

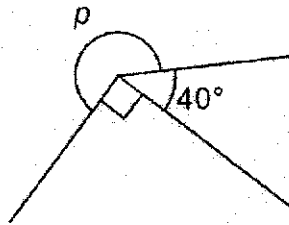

Ans: _____ °



- 19 A movie started at 1155 and ended at 1428. What was the duration of the movie?

Do not
write in
this
space.

Ans: _____ h _____ min

- 20 Calculate the average of the following numbers:

6 7 3 0 4

Ans: _____



Questions 21 to 30 carry 2 marks each. Show your working clearly and write your answers in the spaces provided. For questions which require units, give your answer in the units stated. (20 marks)

Do not write in this space.

- 21 The product of 2 whole numbers is 60. The sum of these 2 numbers is 19. What is the difference between these 2 numbers?

Ans: _____

- 22 3 different types of masses, A, B and C are balanced as shown in the 2 balances below.

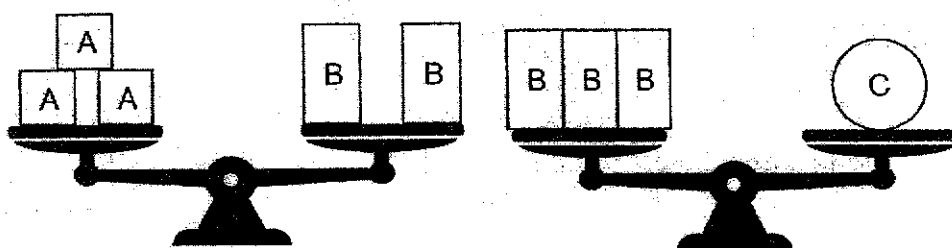

How many mass A are needed to balance 2 mass C?

Ans: _____

--

- 23 The diagram below shows 2 overlapping squares.

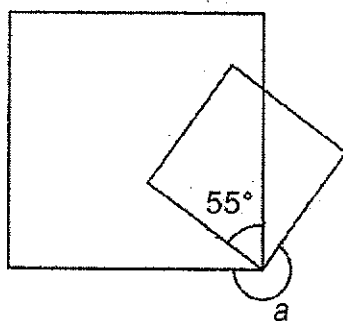

Find $\angle a$.

Ans: _____°

- 24 PQST is a parallelogram as shown below. $\angle PTS = 75^\circ$ and $\angle TPS = 35^\circ$.

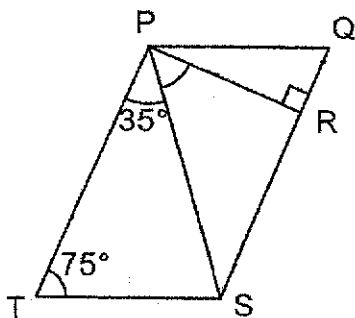

Find $\angle SPR$.

Ans: _____°

Do not
write in
this
space.

--

- 25 After Ali spent $\frac{3}{5}$ of his money and Bala spent $\frac{4}{7}$ of his money, each of them had \$72 left. How much more money did Ali have than Bala at first?

Do not write in this space.

Ans: \$ _____

- 26 The figure below shows a semicircle with centre O. Triangles ABO and OCD are drawn inside the semicircle such that A, B, C and D are points on the semicircle. $\angle OAB = 26^\circ$ and $\angle OCD = 72^\circ$.

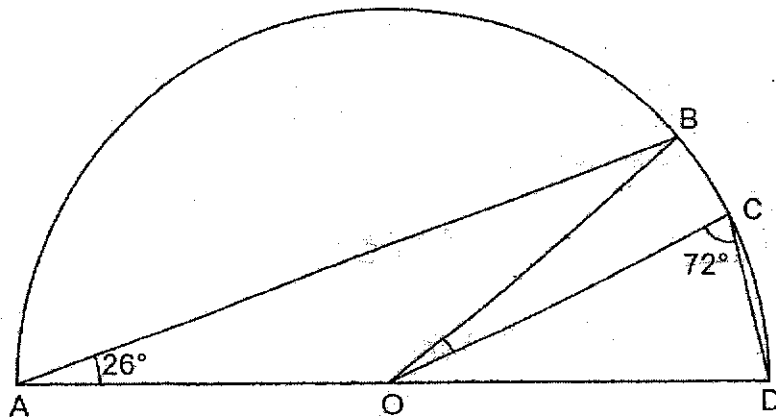

Find $\angle BOC$.

Ans: _____°

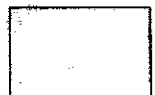

- 27 The cuboid below has a square base. The volume of the cuboid is 576 cm^3 .

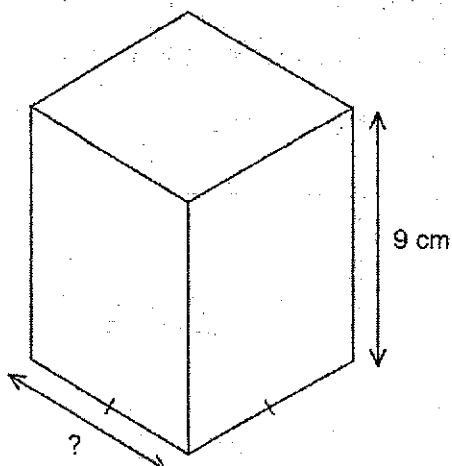

Find the side of the square base.

Ans: _____ cm

- 28 Alex can paint a room in 3 days. Bernard can paint the same room in 5 days. If they work together, how many days do they need to paint the room? Express your answer as a mixed number in the simplest form.

Ans: _____

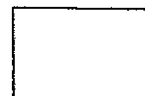

Do not
write in
this
space.

- 29 Andrew was supposed to divide a number by 8. However, he made a mistake and divided the number by 6 instead. As a result, the answer he obtained was 4 more than the correct answer. What number was Andrew supposed to divide?

Do not write in this space.

Ans: _____

- 30 The figure below shows a square and a rectangle. Both shapes have the same perimeter.

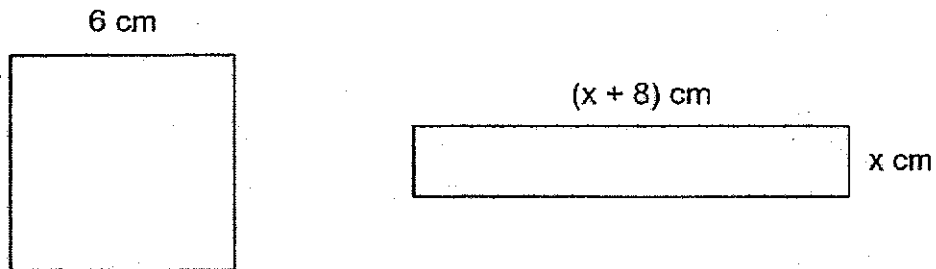

What is the value of x ?

Ans: _____

End of Booklet B





MARIS STELLA HIGH SCHOOL (PRIMARY)
PRELIMINARY EXAMINATION
PRIMARY 6 MATHEMATICS
16 AUGUST 2024
PAPER 2

17 questions

55 marks

Time: 1 h 30 min

NAME : _____ ()

CLASS : PRIMARY 6 _____

INSTRUCTIONS TO CANDIDATES

1. DO NOT OPEN THIS BOOKLET UNTIL YOU ARE TOLD TO DO SO.
2. FOLLOW ALL INSTRUCTIONS CAREFULLY.
3. ANSWER ALL QUESTIONS.
4. SHOW YOUR WORKINGS CLEARLY AS MARKS ARE AWARDED FOR CORRECT WORKING.
5. WRITE YOUR ANSWERS IN THIS BOOKLET.
6. YOU ARE **ALLOWED** TO USE A CALCULATOR.

MARKS OBTAINED FOR

PAPER 1 (BOOKLET A & B)	/ 45	Parent's Signature: _____
PAPER 2	/ 55	
TOTAL	/100	Date: _____

Questions 1 to 5 carry 2 marks each. Show your working clearly and write your answers in the space provided. For questions which require units, give your answers in the units stated.

(10 marks)

Do not write in this space

1 The diagram below shows some shapes.

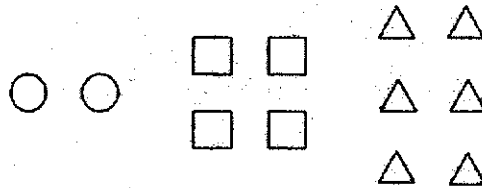

What is the ratio of the total number of shapes to the number of squares?
Express your answer in the simplest form.

Ans: _____

2 $15\frac{4}{5}$ kg of sugar was packed into bags of $\frac{5}{8}$ kg each.

(a) What was the maximum number of bags of sugar?

Ans: (a) _____

(b) How much sugar was left unpacked?

Ans: (b) _____ kg



- 3 The rhombus and rectangle shown below are made up of identical right-angle triangles.

Do not write in this space

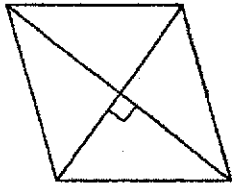

Perimeter = 42 cm



Perimeter = 34 cm

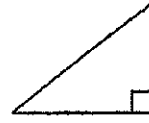

Perimeter = ?

What is the perimeter of the right-angle triangle?

Ans: _____ cm

- 4 The average height of a group of boys was 1.5 m. After 12 boys joined the group, the average height of all the boys increased to 1.65 m. How many boys were there in the group at first?

Ans: _____

--

- 5 In the figure below, ABC and ACD are triangles.
 $\angle ABC = 39^\circ$ and $\angle ADC = 111^\circ$.

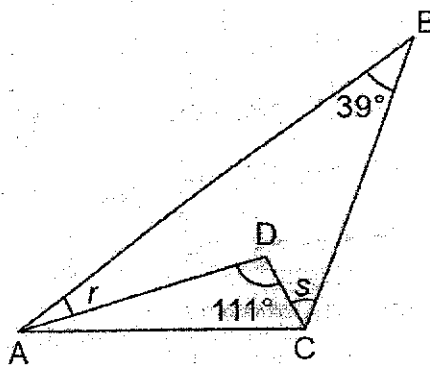

What is the sum of $\angle r$ and $\angle s$?

Do not
write in
this
space

Ans: _____^o

--

For questions 6 to 17, show your working clearly and write your answers in the spaces provided. The number of marks available is shown in brackets [] at the end of each question. (45 marks)

Do not write in this space

- 6 The price of 3 items sold at a bookshop are shown below.



Pencil: $(x + 60) \phi$



Pen: \$2



Ruler: $3x \phi$

- (a) Chester bought 1 pencil and 2 pens. Express the cost of the 3 items in terms of x .

Ans: (a) _____ [1]

- (b) Joseph bought a pencil and a ruler. If $x = 60$, how much did he spend?

Ans: (b) _____ [2]

--

- 7 Mr. Johnson drove at an average speed of 76 km/h from Town A to Town B which was 209 km away.

Do not
write
in
this
space.

- (a) What was the duration of the journey? Express your answer in hours.

Ans: (a) _____ [1]

- (b) From Town B, he drove for another 2 h 36 min and arrived at Town C. The distance between Town B and Town C was 153.4 km. What was the average speed he drove from Town B to Town C? Express your answer in km /h.

Ans: (b) _____ [2]

--

- 8 The table below shows the number of students who borrowed books from the school library in August.

Number of books borrowed	1	2	3	4	5 and above
Number of students	82	34	30	?	16

Do not write in this space.

- (a) How many students borrowed less than 3 books?

Ans: (a) _____ [1]

- (b) The number of students who borrowed exactly 4 books was approximately 24% (rounded to the nearest percentage). What was the smallest possible number of students who borrowed exactly 4 books?

Ans: (b) _____ [2]

- 9 ABC is a straight line. ABE and BCD are triangles.
 $\angle BDC = 36^\circ$ and $\angle BEA = 51^\circ$.

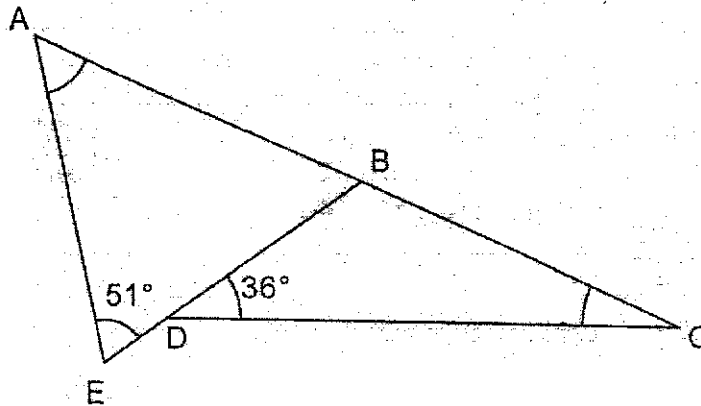

Do not write in this space.

- (a) $\angle BCD = \frac{7}{9}$ of $\angle BDC$. Find $\angle BCD$.

Ans: (a) _____ [1]

- (b) Find $\angle BAE$.

Ans: (b) _____ [1]

- (c) Circle the word(s) that describe ABE in the following statement. [1]

ABE (is / is not) an isosceles triangle.

- 10 The table below shows some information about the number of boys and girls in Schools A and B.

	Boys	Girls	Total
School A	637		
School B			
Total		1118	2298

Do not
write in
this
space.

- (a) What is the total number of boys in both schools?

Ans: (a) _____ [1]

The number of girls in School B is $\frac{5}{8}$ of the number of girls in School A.

- (b) How many girls are there in School A?

Ans: (b) _____ [1]

- (c) What is the total number of boys and girls in School A?

Ans: (c) _____ [1]

- 11 Triangle BCE, as shown below, forms part of a rhombus ABCE.

Do not
write in
this
space.

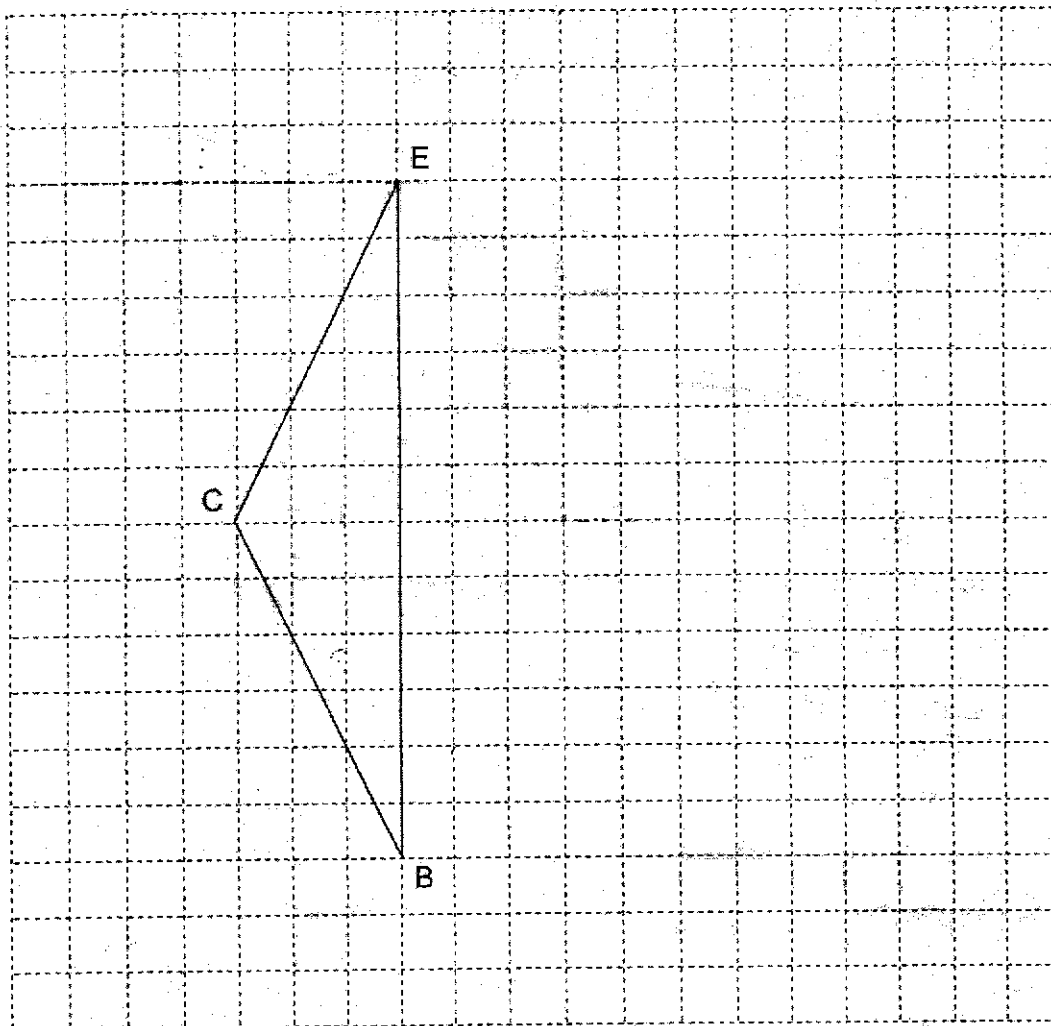

- (a) Measure $\angle ECB$.

Ans: (a) _____ [1]

- (b) On the square grid above, complete the drawing of rhombus ABCE and label point A. [1]
- (c) CDE is an isosceles triangle which does not overlap with rhombus ABCE such that $\angle BED = 90^\circ$. On the square grid above, complete the drawing of CDE and label point D. [1]

--

- 12 The graph below shows the height of a plant from January to April.

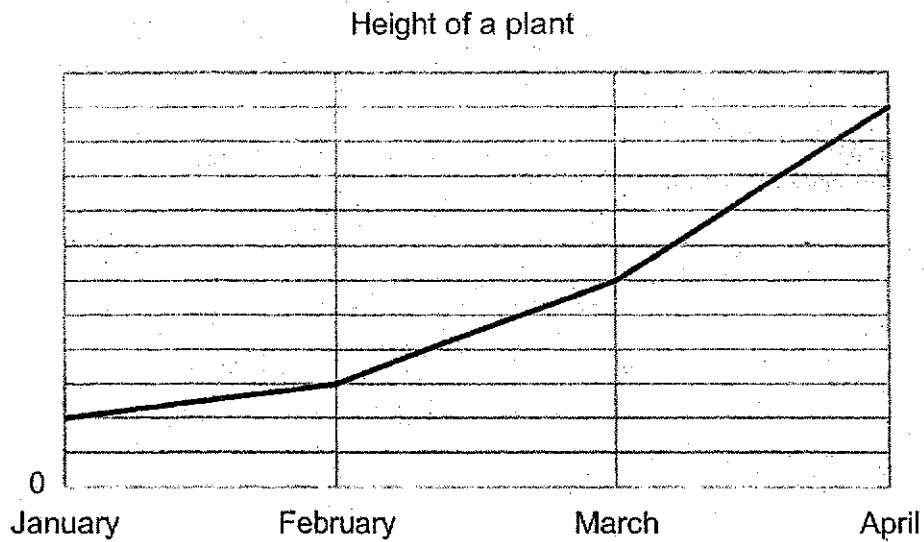

Do not write in this space.

- (a) In which one month interval was the percentage increase of the height the greatest?

Ans: (a) _____ to _____ [2]

- (b) The average height of the plant during this period was 16.5 cm. What was the height of the plant in March?

Ans: (b) _____ [2]

- 13 PQS and QRS are isosceles triangles such that the height of Triangle PQS is thrice the height of Triangle QRS. The shaded area is 289 cm^2 .

Do not write in this space.

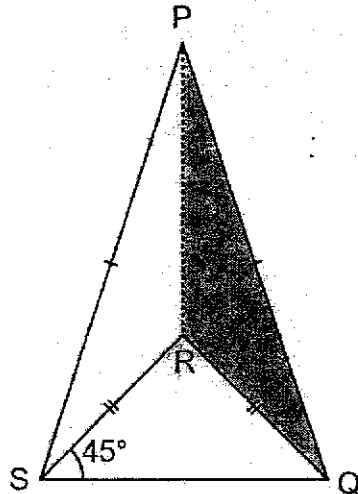

- (a) Find the area of Triangle PQS.

Ans: (a) _____ [2]

- (b) Find the length of SQ.

Ans: (b) _____ [2]

--

14 For a Mathematics competition, 5 points were awarded for a correct response and 3 points were deducted for an incorrect response.

- (a) In a competition of 20 questions, Chester answered 3 questions wrongly. How many points did he get?

Do not write in this space.

Ans: (a) _____ [2]

- (b) In the competition that Dominic took part in, there were less than 100 questions. He scored exactly 0 points. What is the maximum number of questions he answered correctly?

Ans: (b) _____ [2]

--

- 15 The ratio of the number of boys to the number of girls who visited a funfair was in the ratio of 10 : 7. The entrance fee for each person was \$12 and a total of \$4692 was collected from the children.

Do not
write in
this
space.

- (a) How many boys were there?

Ans: (a) _____ [2]

On that same day, the ratio of the number of males (boys and men) to the number of females (girls and women) who visited the funfair was 8 : 5. There were 54 more men than women.

- (b) How many women were there?

Ans: (b) _____ [3]

--

- 16 A large square tile of sides 48 cm is painted with circles in a fixed pattern shown below. Part of the tile is covered by a piece of cloth. The ratio of the radius of the small circle to the radius of the large circle is 1 : 3. The diameter of the small circle is 2 cm.

Do not write in this space.

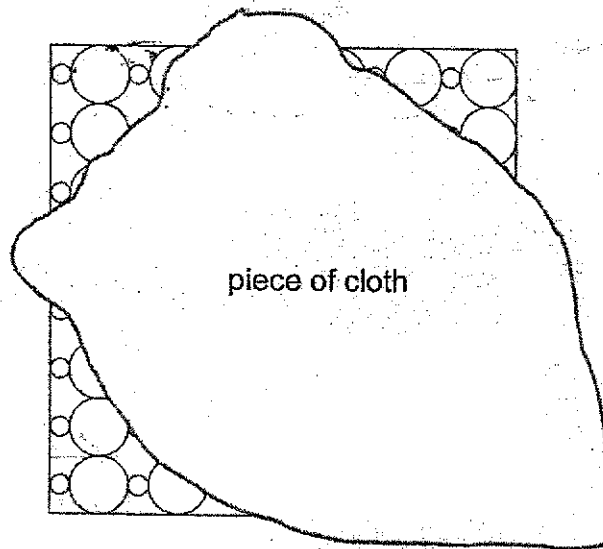

- (a) How many circles are printed on this square tile?

Ans: (a) _____ [3]

- (b) Find the percentage of the area of the square tile that is not covered with circles. Round your answer to the nearest percentage.
(Take $\pi = 3.14$)

Do not
write in
this
space.

Ans: (b) _____ [2]

--

- 17 There were some 10¢, 20¢ and 50¢ coins in a box. There were 34 more 10¢ coins than 20¢ coins. The total value of all the 10¢ coins and 20¢ coins was \$13.30.

Do not
write in
this
space.

- (a) How many 10¢ coins were there in the box?

Ans: (a) _____ [2]

$\frac{2}{3}$ of the 50¢ coins were exchanged for \$1 coins which were then placed in the box. The total value of all the coins in the box did not change but the mass of all the coins in the box decreased by 172.8 g. The mass of each 50¢ coin is 6.5 g and the mass of each \$1 coin is 7.6 g.

- (b) What was the total number of 50¢ and \$1 coins in the box after the exchange?

Do not
write in
this
space.

Ans: (b) _____ [3]

End of Paper 2.

SCHOOL : MARIS STELLA SCHOOL
 LEVEL : PRIMARY 6
 SUBJECT : MATH
 TERM : 2024 PRELIM

Q 1	Q2	Q3	Q4	Q5	Q6	Q7	Q8	Q9	Q10
4	4	2	3	2	1	4	2	3	1
Q11	Q12	Q13	Q14	Q15					
3	2	3	1	1					

Q16)	5050050
Q17)	330 cm ²
Q18)	360 - 90 = 270 270 - 40 = 230°
Q19)	2h 33 min
Q20)	4
Q21)	11
Q22)	9
Q23)	90 - 55 = 35 35 + 35 = 70 360 - 70 = 290 290 - 55 = 235°
Q24)	180 - 90 = 90 90 - 75 = 15 180 - 75 = 105 105 - 35 = 70 70 - 15 = 55°
Q25)	\$12
Q26)	16°
Q27)	576 ÷ 9 = 64 8 x 8 = 64 ANS: 8
Q28)	1 $\frac{7}{8}$
Q29)	96

Q30)	2
------	---

Paper 2 Answers

Q1	$12 : 4 = 3 : 1$ (Ans)
Q2	(a) $15\frac{4}{5} \div \frac{5}{8} = 25\frac{7}{25}$ (Ans) = 25 (b) $\frac{7}{5} \times \frac{5}{8} = \frac{7}{8}$ (Ans)
Q3	$42 \div 4 = 10.5$ $34 \div 2 = 17$ $10.5 + 17 = 27.5$ (Ans)
Q4	***This question is voided by school due to error in question***
Q5	$180^\circ - 111^\circ = 69^\circ$ $180^\circ - 69^\circ - 39^\circ = 72^\circ$ (Ans)
Q6	(a) $(x + 60)\phi + \$2 + \2 $= x + 60\phi + 400\phi$ $= x + 460\phi$ (Ans) (b) $(x + 60)\phi + (3x)\phi$ $= (60+60)\phi + (3*60)\phi$ $= 120\phi + 180\phi$ $= 300\phi = \$3$ (Ans)
Q7	(a) $209 \div 76 = 2.75$ hours (Ans) (b) $2\text{h } 36\text{mins} = 2\frac{36}{60} = 2\frac{3}{5} = 2.6$ hours Ave Speed = $153.4 \div 2.6 = 59\text{km/h}$ (Ans)
Q8	(a) $82 + 36 = 116$ (Ans) (b) $82 + 34 + 30 + 16 = 162$ $100\% - 24\% = 76\%$ $76\% = 162$ $24\% = \frac{24}{76} \times 162 = 51.16$ - $51.16 + 162 = 213$ *** $\frac{51}{213} \times 100\% = 23.9\%$ - $50 + 162 = 212$ *** $\frac{50}{212} \times 100\% = 23.6\%$ Therefore (Ans) 50
Q9	(a) $\frac{7}{9} \times 36^\circ = 28^\circ$ (Ans) (b) $\angle DBC = 180^\circ - 36^\circ - 28^\circ = 116^\circ$ $\angle ABE = 180^\circ - 116^\circ = 64^\circ$ $\angle BAE = 180^\circ - 51^\circ - 64^\circ = 65^\circ$ (Ans) (c) "Is Not" (Ans)

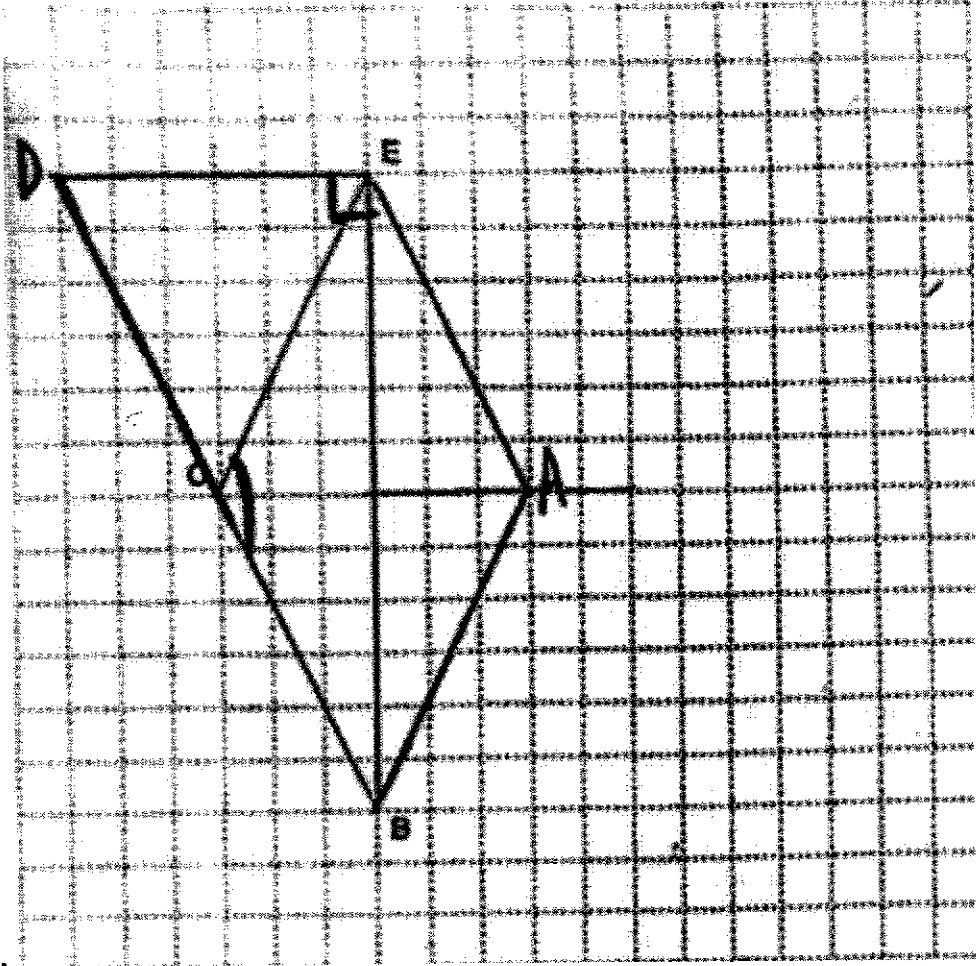
10	<p>(a) $2298 - 1118 = 1180$ (Ans) $13u = 1118$ $1u = 86$ $8u = 86 \times 8 = 688$ (Ans)</p> <p>(b) $637 + 688 = 1325$ (Ans)</p>
Q11	<p>(a) 127° (Ans)</p>  <p>(b) .</p> <p>(c) .</p>
Q12	<p>(a) Feb to March (Ans)</p> <p>(b) $16.5 \times 4 = 66$ $2 + 3 + 6 + 11 = 22$ $22u = 66$ $u = 3$ $6u = 18\text{cm}$ (Ans)</p>

Q13	<p>(a) Area of $\triangle PQS = \frac{1}{2} \times B \times 3H$ Area of $\triangle QRS = \frac{1}{2} \times B \times H$ $289 \times 3 = 867\text{cm}^2$ (Ans)</p> <p>(b) $289 \times 4 = 1156$ $\sqrt{1156} = 34$ (Ans)</p>
Q14	<p>(a) $17 \times 5 = 85$ $3 \times 3 = 9$ $85 - 9 = 76$ (Ans)</p> <p>(b) Multiple of 8 (Greatest and less than 100) = 96</p> <p style="text-align: center;">Total</p> <p>5 : 3 8 60 : 36 96 (Ans) 36</p>
Q15	<p>(a) Boy : Girls Total 10 : 7 17 $17 \times \\$12 = \\204 $4692 \div 204 = 23$ $23 \times 10 = 230$ (Ans)</p> <p>(b) Male : Female = 8 : 5 Ratio difference = 3 $54 \div 3 = 18$ Male : Female = 8 : 5 = $8 \times 18 : 5 \times 18$ = 144 : 90 (Ans) 90 women</p>

Q16	<p>(a) $2 + 6 = 8$ $48 \div 8 = 6$ $48 \div 6 = 8$ $6 \times 8 \times 2 = 96$</p> <p>(b) $\pi \times 1 \times 1 \times 48$ $= 3.14 \times 48$ $= 150.72 \text{ cm}^2$ $\pi \times 3 \times 3 \times 48$ $= 3.14 \times 9 \times 48$ $= 1356.48 \text{ cm}^2$ Area of square $= 48 \times 48 = 2304 \text{ cm}^2$ $2304 - 1356.48 - 150.72 = 796.80 \text{ cm}^2$ $\therefore \frac{796.8}{2304} \times 100\% = 34.58\% = 35\% \text{ (Ans)}$</p>
Q17	<p>(a) $34 \times 10\text{¢} = 340\text{¢} = \\3.40 $\\$13.30 - \\$3.40 = \\$9.90$ $\\$9.90 \div \\$0.30 = 33$ $33 + 34 = 67 \text{ (Ans)}$</p> <p>(b) $50\text{¢ coin} = 6.5\text{g}$ $2 \times 50\text{¢ coins} = 6.5\text{g} \times 2 = 13\text{g}$ $\\$1 \text{ coin} = 7.6\text{g}$ weight difference between $\\$1$ coin and 50¢ coin $13\text{g} - 7.6\text{g} = 5.4\text{g}$ $172.8\text{g} \div 5.4\text{g} = 32$ 32 sets of $(2 \times 50\text{¢ coins})$ was changed to $\\$1$ coin $\frac{2}{3}$ of the initial 50¢ coins $= 32 \times 2 = 64\text{pcs}$ 64pcs of 50¢ coins changed to 32pcs of $\\$1$ coins $\frac{1}{3}$ of the balance 50¢ coins $= 32\text{pcs}$ of 50¢ coins</p> <p>32 pcs of 50¢ coins and 32 pcs of $\\$1$ coins Ans : Total 64 coins</p>