

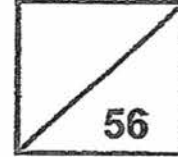

Rosyth School
First Semestral Assessment 2017
STANDARD SCIENCE
Primary 6



Name: _____

Total
Marks:

Class: Pr 6 _____ Register No. _____ Duration: 1 h 45 min

Date: 9 May 2017 Parent's Signature: _____

Booklet A

Instructions to Pupils:

1. Do not open the booklets until you are told to do so.
2. Follow all instructions carefully.
3. This paper consists of 2 booklets - Booklet A and Booklet B
4. For questions 1 to 28 in Booklet A, shade the correct ovals on the Optical Answer Sheet (OAS) provided using a 2B pencil.
5. For questions 29 to 40, give your answers in the spaces given in the Booklet B.

* This booklet consists of 18 printed pages (including cover page).

Part I

For each question from 1 to 30, four options are given. One of them is the correct answer. Make your choice (1, 2, 3 or 4). Shade the correct oval (1, 2, 3 or 4) on the Optical Answer Sheet. (56 Marks)

1 Some living things are classified into two groups as shown in the chart below.

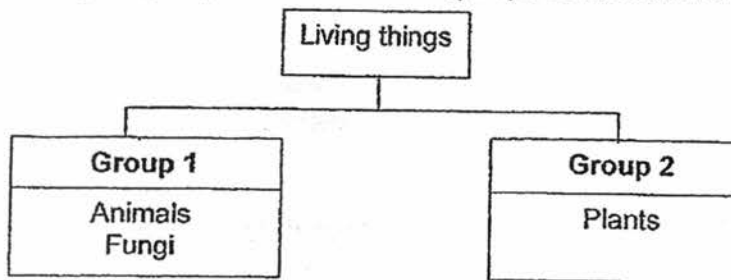

Which of the following are suitable headings for the two groups?

	Group 1	Group 2
(1)	Not able to make its own food	Able to make its own food
(2)	Reproduce by spores	Reproduce by seeds
(3)	Produce carbon dioxide	Do not produce carbon dioxide
(4)	Need oxygen to stay alive	Do not need oxygen to stay alive

2 The picture below shows an animal, X.

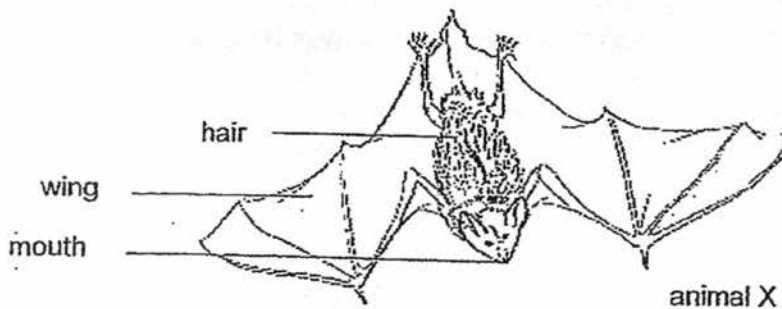

X is not classified in the same group of animals as a bird. Some students made the following statements to explain why.

- A X has hair but a bird has feathers.
- B X does not have a beak but a bird has a beak.
- C X has wings larger than its body but a bird does not.

Which of the statements are correct?

- (1) C only
- (2) A and B only
- (3) B and C only
- (4) A, B and C

3. Nancy wants to conduct an experiment to find out if an organism needs water to survive. A tick (✓) in the table below indicates that the condition is present in the set-up.

Conditions	Set-up			
	A	B	C	D
Air	✓	✓		✓
Food		✓	✓	✓
Water	✓		✓	✓

Which set-up(s) should she use?

- (1) D only
 (2) A and C only
 (3) B and D only
 (4) A, B and C
- 4 The diagram shows a plant cell.

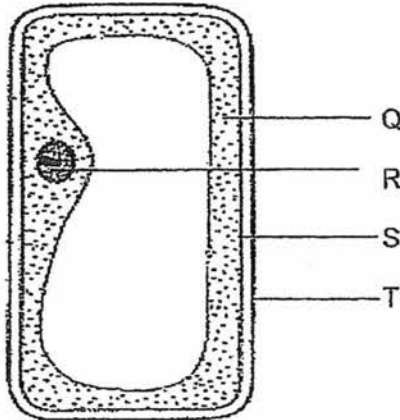

Which part is not found in animal cells?

- (1) Q
 (2) R
 (3) S
 (4) T

- 5 The diagram shows an investigation on photosynthesis. The plant has leaves that are green in the middle and white around the edges.

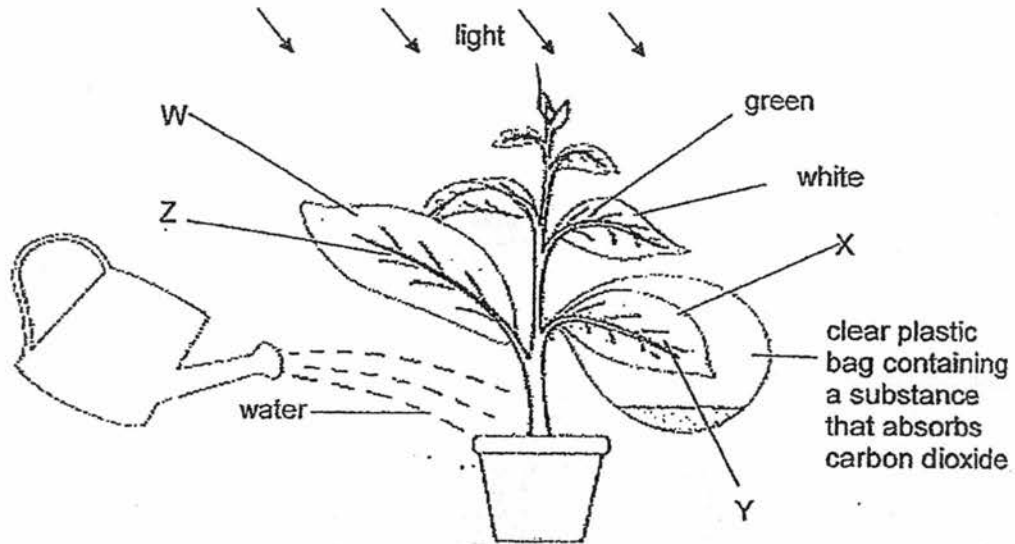

Which leaf areas lack only one condition needed for photosynthesis?

- (1) W and X
(2) X and Z
(3) Z and Y
(4) W and Y

- 6 Four tubes are left in the sunlight for one hour. The solution in each tube is red at the start of the experiment. The diagram below shows how the colour of the solution changes with changes in the amount of carbon dioxide.

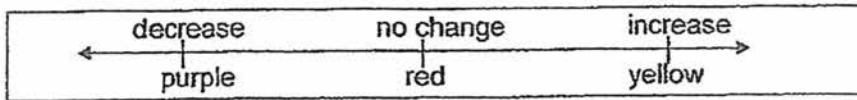

In which tube does the colour of the solution change to purple?

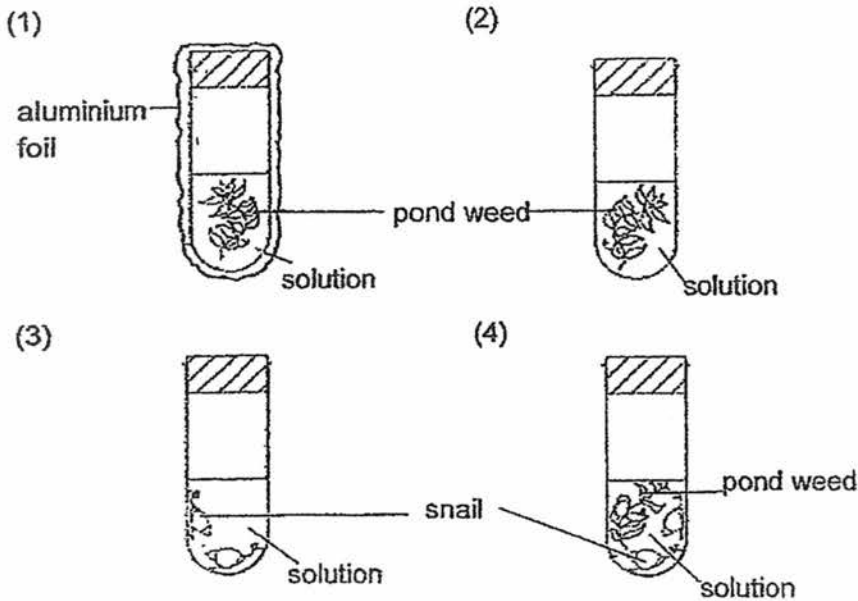

- 7 The diagram below shows how food and various gases are transported in the human body.

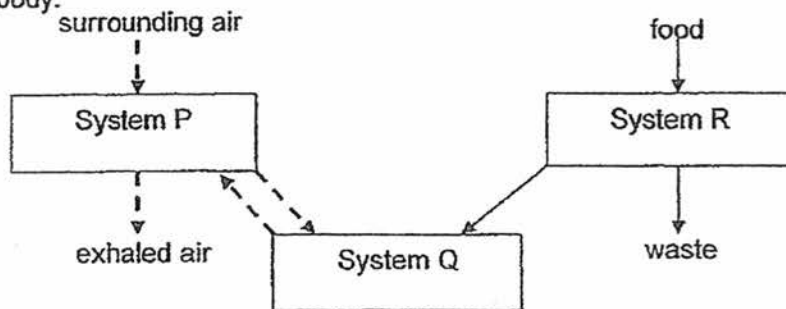

Which of the following correctly identifies P,Q and R?

	System P	System Q	System R
(1)	circulatory	digestive	respiratory
(2)	respiratory	digestive	circulatory
(3)	respiratory	circulatory	digestive
(4)	digestive	respiratory	circulatory

- 8 The diagrams below show the circulatory systems of two organisms, a fish and a mammal. The arrows represent the blood vessels that carry blood from the gills or the lungs to the other parts of the body.

Circulatory system of a fish

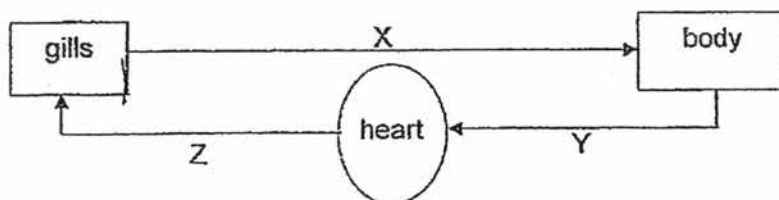

Circulatory system of a mammal

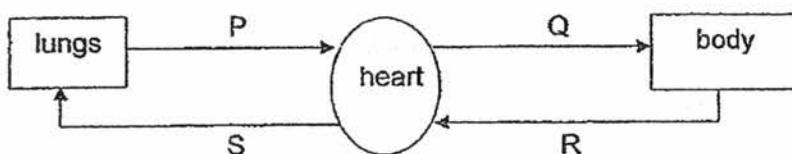

Based on the diagrams above, which of the following statements is/are correct?

- A Only blood vessels X, P and Q carry oxygen-rich blood.
- B Only blood vessels Y, Z, R and S carry carbon dioxide-rich blood.
- C Oxygen-rich blood from the gills goes to the heart like the blood in blood vessel P.

- (1) A and B only
- (2) B and C only
- (3) A and C only
- (4) A, B and C

- 9 Study the table about the plant transport system and human circulatory system.

	Plant Transport System	Human Circulatory System
A	Has tubes that transport materials	Does not have tubes to transport materials
B	Transports food produced by the leaves only	Transports undigested food only
C	Transports water, dissolved mineral salts and food to all parts of the plant	Transports digested food, oxygen, carbon dioxide, water and waste materials
D	Has no part to pump the substances through the system	Has a heart to pump blood through the system

Which of the above comparisons are false?

- (1) A and B only
- (2) C and D only
- (3) A, B and C only
- (4) B, C and D only

- 10 R, S and T are 3 organisms that live in a community.
R is a decomposer.
S is a producer.
T is a consumer.

Which diagram below shows the direction of the flow of energy in the community?

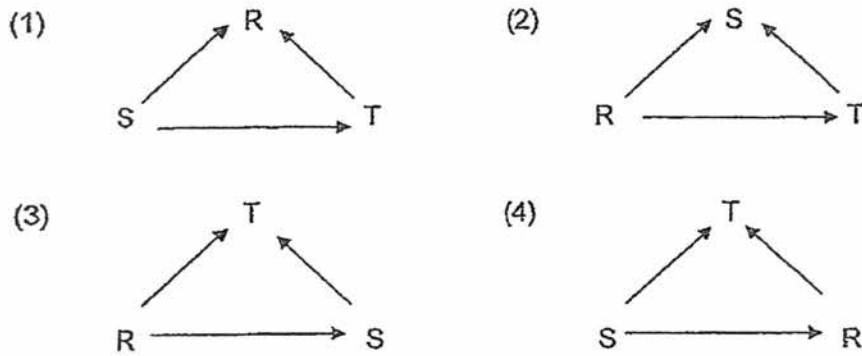

- 11 The diagram below shows a tree community.

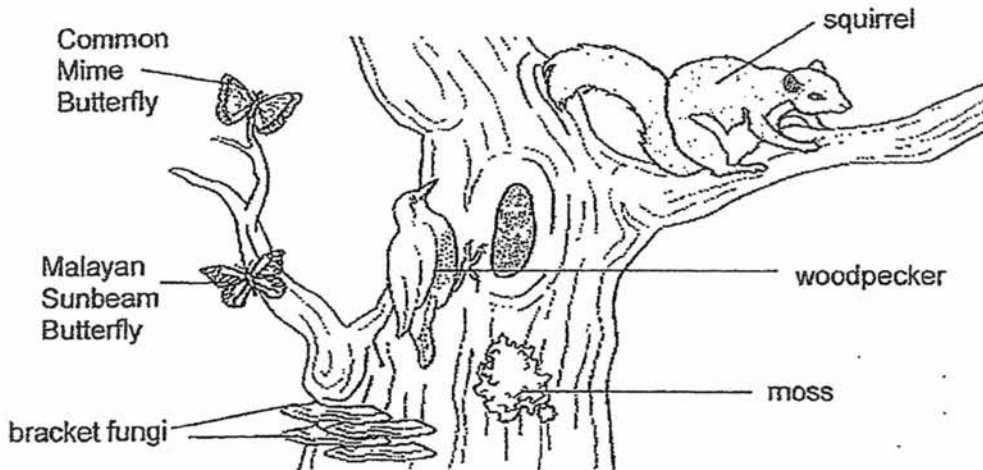

Which of the following sets of organisms are part of the same population in the tree community?

- (1) tree and moss (2) woodpecker and squirrel
(3) two different types of butterflies (4) four bracket fungi on the trunk

12 The graph below shows the number of water snails in a pond.

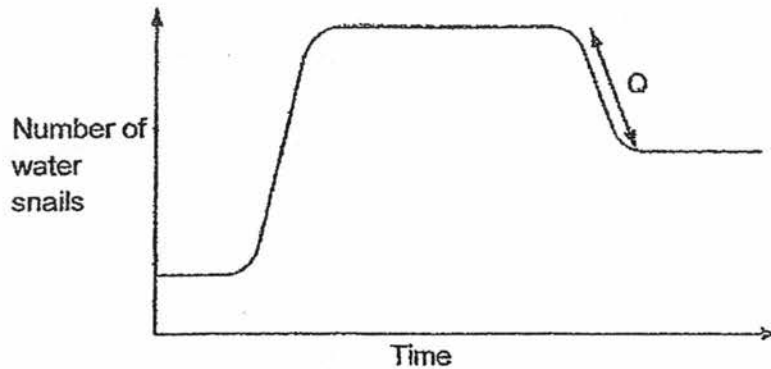

What might have been the reason for the section Q on the graph?

- (1) Addition of water plants to the pond
- (2) Increase in the birth rate of water snails
- (3) Increase in food supply for the water snails
- (4) Addition of predators that feed on water snails

13 The graph below shows the effect of temperature of the environment on the populations of 4 different organisms W, X, Y and Z

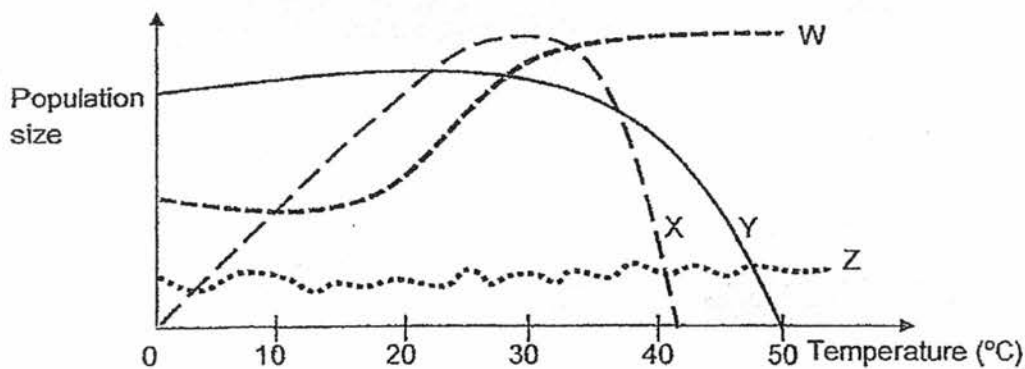

Which one of the following statements is correct?

- (1) W survives better when the temperature is below 30°C.
- (2) X can only survive when the temperature is about 30°C.
- (3) Y is the most sensitive to any change in the temperature.
- (4) Z is the least affected by changes in the temperature compared to the rest.

14 The diagram shows a fruit attached to a parachute of hairs.

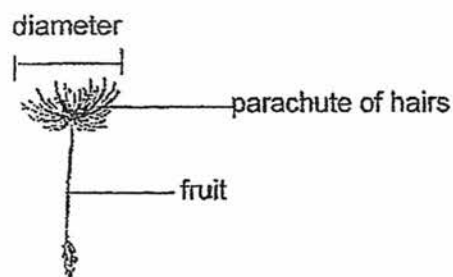

The following results were obtained during an experiment to investigate the time taken for four fruits, A, B, C and D with different diameters of parachute of hairs to fall to the ground.

Fruit	Diameter of parachute of hairs (cm)	Time taken to fall (s)
A	1.2	4.5
B	1.0	4.0
C	0.7	2.5
D	0.4	1.5

What conclusion can be drawn from the results?

- (1) Fruit D fell the slowest and fruit A fell the fastest.
- (2) Fruit size affects the time taken for the fruit to fall.
- (3) The fruits are well adapted for dispersal by animals.
- (4) As the parachute diameter increases, the time taken to fall increases.

- 15 A factory makes 6 types of materials, A, B, C, D, E and F. The materials are classified in the table below.

Does not allow light to pass through at all	Allow most light to pass through
A	C
B	D
E	F

Five children were asked to test the materials by standing behind the walls made of the materials as shown in the diagram below.

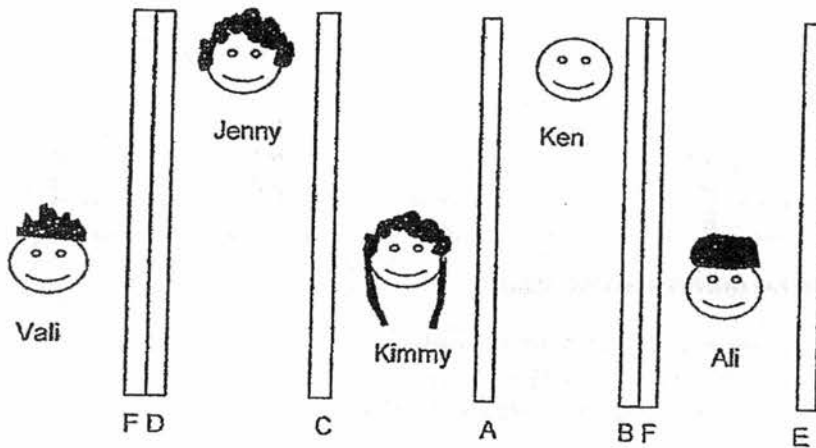

Which of the following statements are true?

- A Ali can see Ken.
- B Kimmy can see Vali.
- C Vali cannot see Ken.
- D Jenny cannot see Kimmy.

- (1) A and D only
- (2) B and C only
- (3) A, B and C only
- (4) B, C and D only

- 16 Sarah set up an experiment in a dark room. She shone a torch on a ball as shown in the diagram below. A shadow of the ball was cast on the screen.

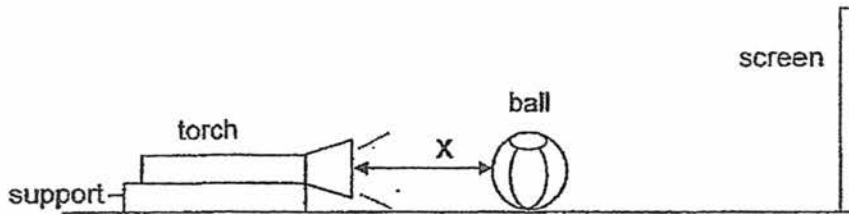

What could Sarah do to enlarge the shadow on the screen?

- A Move the torch towards the ball.
- B Move the screen towards the ball.
- C Move the torch away from the ball
- D Move the screen away from the ball.

- (1) A and B only
- (2) A and D only
- (3) B and C only
- (4) C and D only

- 17 The table below shows the state of 4 substances W, X, Y and Z at different temperatures.

Substance	State of substance at 25°C	State of substance at 60°C	State of substance at 95°C
W	Solid	Solid	Liquid
X	Liquid	Gaseous	Gaseous
Y	Solid	Liquid	Gaseous
Z	Solid	Liquid	Liquid

Which substance has the lowest boiling point?

- (1) W
- (2) X
- (3) Y
- (4) Z

18 Study the experiment below.

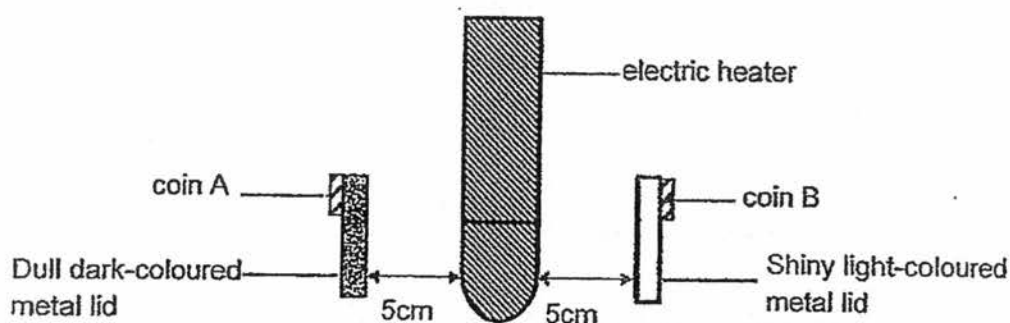

Two coins, A and B were attached to the 2 metal lids by the same amount of wax. After the electric heater is turned on, which coin, A or B, will drop off first and explain why.

- (1) A, because dull and dark-coloured surfaces can reflect heat better.
- (2) A, because dull and dark-coloured surfaces can absorb heat better.
- (3) B, because shiny and light-coloured surfaces can reflect heat better.
- (4) B, because shiny and light-coloured surfaces can absorb heat better.

19 Mandy wanted to find out how the temperature of the water affects the rate of evaporation of water. She prepared the following set-ups as shown in the table below.

Set-up	A	B	C	D
Variable				
Amount of water in container (cm ³)	100	200	100	200
Exposed surface area of water in container (cm ²)	50	50	45	50
Temperature of water (°C)	28	15	15	28
Temperature of surrounding air (°C)	30	25	15	25

Which 2 set-ups should she choose for her investigation?

- (1) A and B
- (2) A and D
- (3) B and C
- (4) B and D

- 20 Judy filled a pot with some tap water and heated for 10 minutes until it started to boil. She continued boiling it for another 10 minutes before adding some frozen prawns and slices of fish into the boiling water.

Which of the following graphs shows the changes in the temperature of water correctly?

(1)

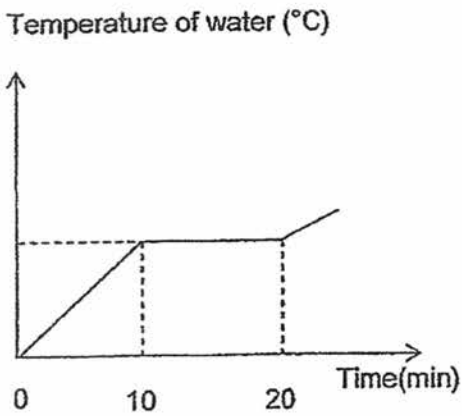

(2)

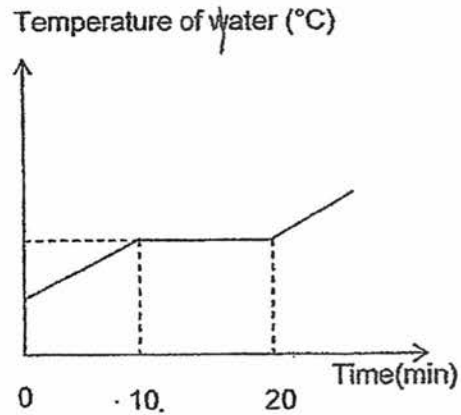

(3)

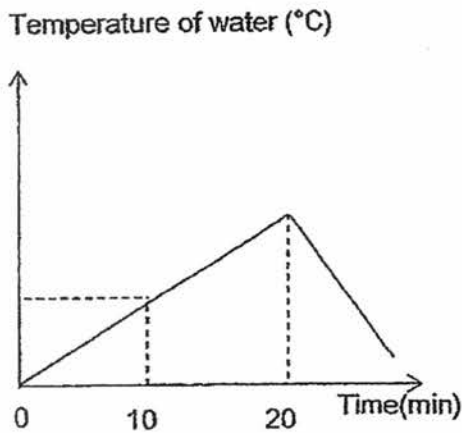

(4)

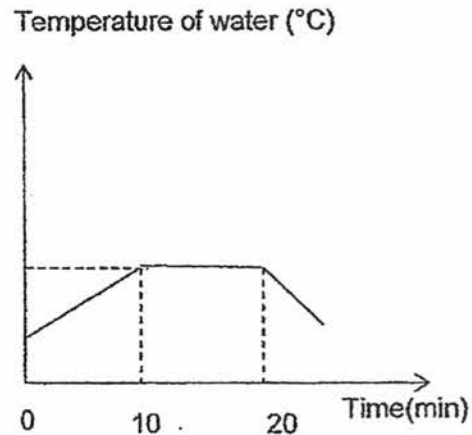

- 21 Ben walked into a cold storage room filled with blocks of ice and immediately he felt very cold.

Which one of the following explanations is correct?

- (1) The blocks of ice lost heat to his body.
- (2) Ben's body lost heat to the cold surrounding air.
- (3) The blocks of ice gained coldness from his body.
- (4) Ben's body gained coldness from the blocks of ice.

22 The diagram below shows the stages, P, Q, R and S in the water cycle.

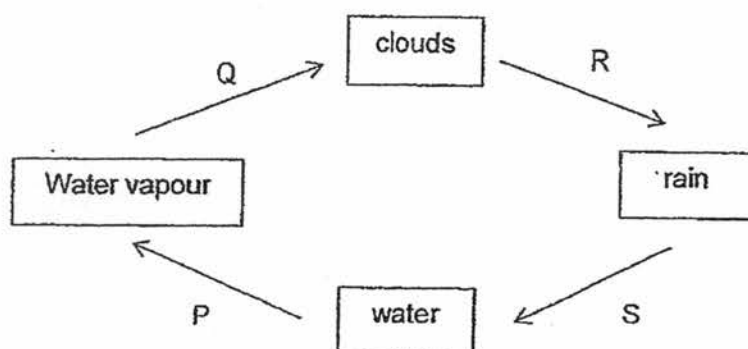

Which stage(s) show(s) a change in the state of water?

- (1) P only
- (2) Q only
- (3) P and Q only
- (4) R and S only

23 The table below shows the main energy conversion of four electrical appliances, S, T, U and V.

Electrical appliances	Energy conversion
S	Electrical energy → Kinetic energy
T	Electrical energy → Heat energy
U	Electrical energy → Sound energy
V	Electrical energy → Light energy

Which of the following electrical appliances correctly represents the energy conversion as shown above?

	S	T	U	V
(1)	Food blender	Oven	Radio	Fan
(2)	Fan	Radio	Oven	Ceiling light
(3)	Food blender	Fan	Ceiling light	Radio
(4)	Fan	Oven	Radio	Ceiling light

24 Dev threw a tennis ball as shown in the diagram below.

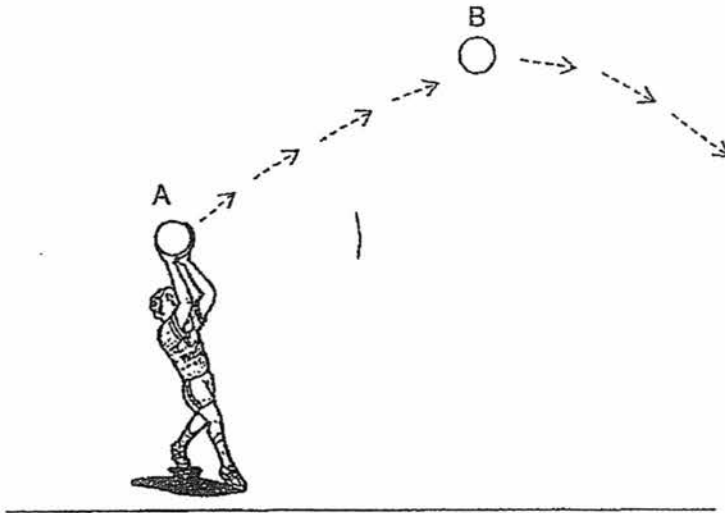

Which of the following is correct, as the ball moved from position A to position B?

- (1) Potential energy is highest at position A.
- (2) Potential energy and kinetic energy is the same at position A.
- (3) Kinetic energy is highest and potential energy is lowest at position B.
- (4) Kinetic energy is lowest and potential energy is highest at position B.

25 Study the diagram and graph below carefully.

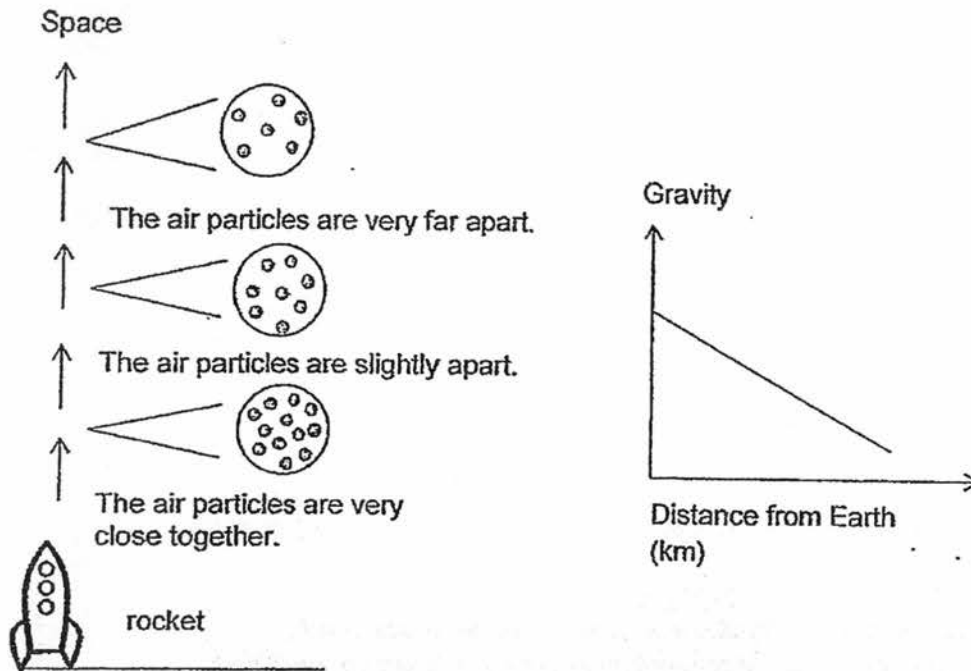

Using the information given above, as the rocket flies towards space it needs less force to fly at a constant speed.

Which of the following(s) can explain the above?

- A The pull of earth's gravity is less.
- B The pull of moon's gravity is less.
- C There is less friction caused by the air.

- (1) A only
- (2) B only
- (3) B and C only
- (4) A and C only

- 26 Owen set up an experiment to test the strength of an electromagnet as shown below. He used the spring balance to measure the force of attraction of the electromagnet on a steel disc.

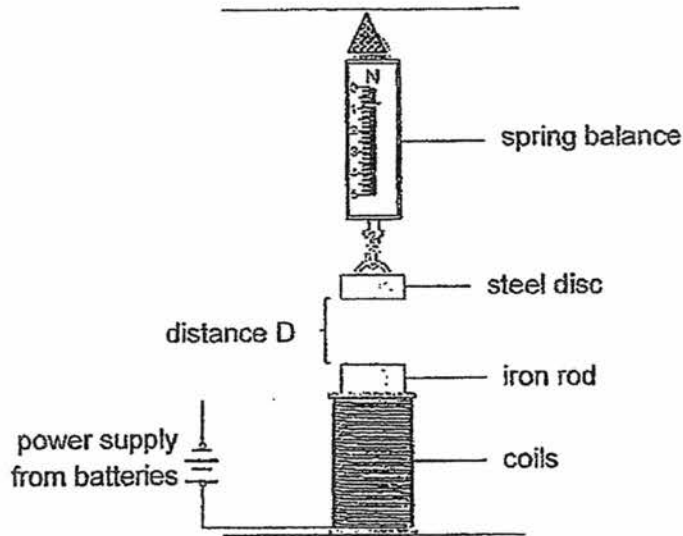

He recorded his results in the table below.

Number of coils	15	30	45	60
Distance D (cm)	10	6	4	2

Owen then made a change to his experiment and carried out the experiment again. The results of his second experiment are shown in the table below.

Number of coils	15	30	45	60
Distance D (cm)	8	4	2	0

Based on the above results, what could be the possible change Owen has made in his second experiment?

- (1) He used a lighter steel disc.
- (2) He applied heat to the iron rod.
- (3) He added more batteries to the set-up.
- (4) He change the iron rod to a steel rod.

- 27 The diagram below shows Kim helping Lim up a steep slope on a hill. Kim and Lim weigh the same.

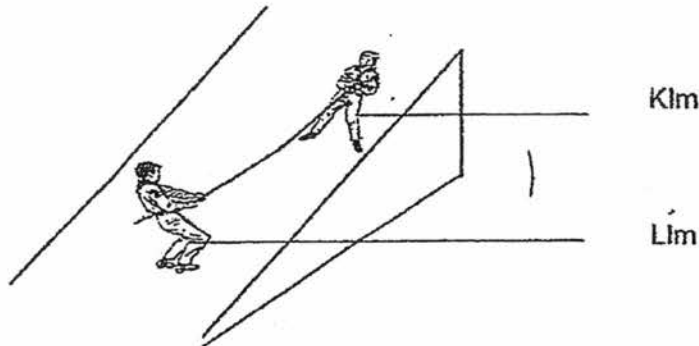

Based on the above diagram, which one of the following statements about the forces acting on Kim and Lim is correct?

- (1) Both boys were exerting a pushing force,
 - (2) Gravitational force acting on both boys is the same.
 - (3) Kim had more gravitational force acting on him than Lim.
 - (4) Kim was exerting a pull force and Lim was exerting a push force.
- 28 Block M is a bar magnet. It was placed on a flat glass table as shown below. A copper block was attached to the bottom of the table. Block M was given a push to move along the table.

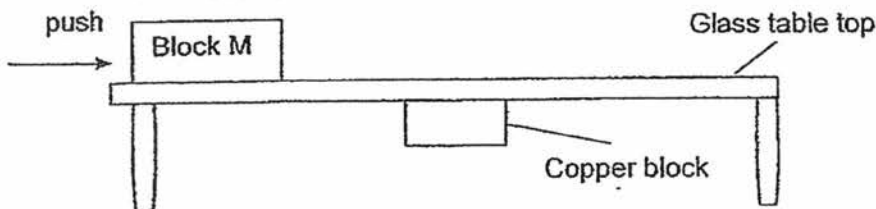

Which of the force(s) below must the push overcome in order for Block M to move along the table?

- (1) Frictional only
- (2) Frictional and Magnetic only
- (3) Frictional and Gravitational only
- (4) Frictional, Gravitational and Magnetic

END OF BOOKLET A



Rosyth School
First Semestral Assessment 2017
STANDARD SCIENCE
Primary 6

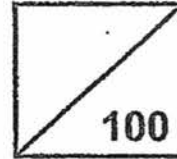

Name: _____

Total
Marks:

Class: Pr 6 _____

Register No. _____

Duration: 1 h 45 min

Date: 9 May 2017

Parent's Signature: _____

Booklet B

Instructions to Pupils:

1. For questions 29 to 40, give your answers in the spaces given in Booklet B.

	Maximum	Marks Obtained
Booklet A	56 marks	
Booklet B	44 marks	
Total	100 marks	

* This booklet consists of 17 printed pages (including cover page).

Part II

For questions 29 to 44, write your answers in the space provided. **(44 Marks)**

29 The diagram below shows a snake.

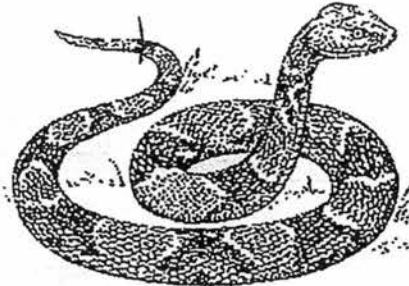

(a) Complete the table below by stating the characteristic of living things related to each behaviour of the snake. **[3]**

Characteristic of living things	Behaviour
(i) _____ _____	Feeds on small animals like rats and mice
(ii) _____ _____	Lays eggs
(ii) _____ _____	Sheds its skin to allow its body to increase its size

A snake is a reptile.

(b) State one difference between a reptile and a fish. **[1]**

30 The diagram below shows a one-celled organism. Arul found it growing on the bark of a tree.

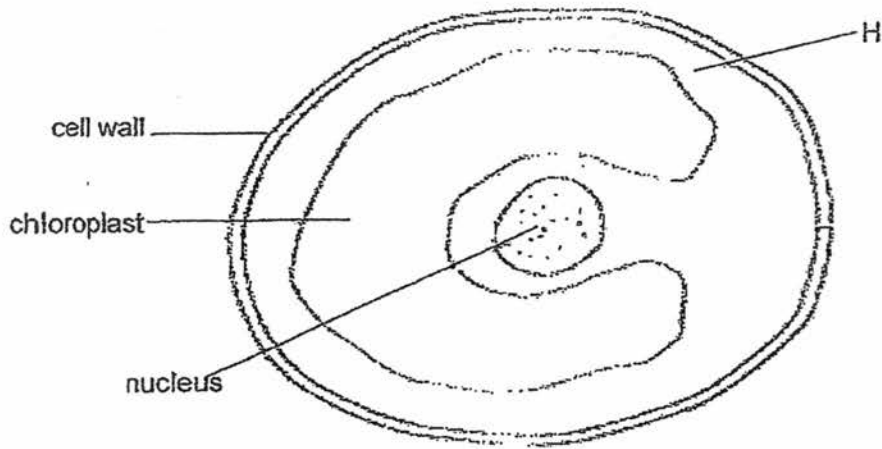

(a) Identify part H. [1]

(b) Label the cell membrane on the diagram above. [1]

(c) Arul says that the organism feeds on other organisms. Do you agree with him? Explain your answer. [1]

- 31 The diagram below shows a large glass jar in which plants are growing. The jar provides an environment in which the plants can live for many months without adding water or removing the tightly-fitting stopper to allow air to enter.

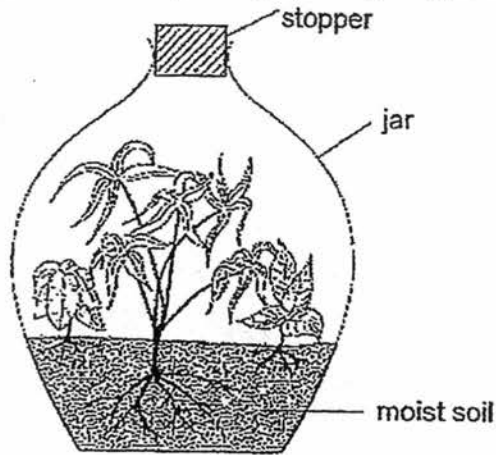

- (a) Suggest why the plants in the jar show only very limited growth compared with similar plants growing under natural conditions? [1]

- (b) The jar is put in a place where there is light. Explain why this is done. [1]

- (c) The stopper prevents surrounding air from entering the jar. Explain how the plants are able to remain alive without a continuous supply of fresh air. [1]

32 Study the diagram below.

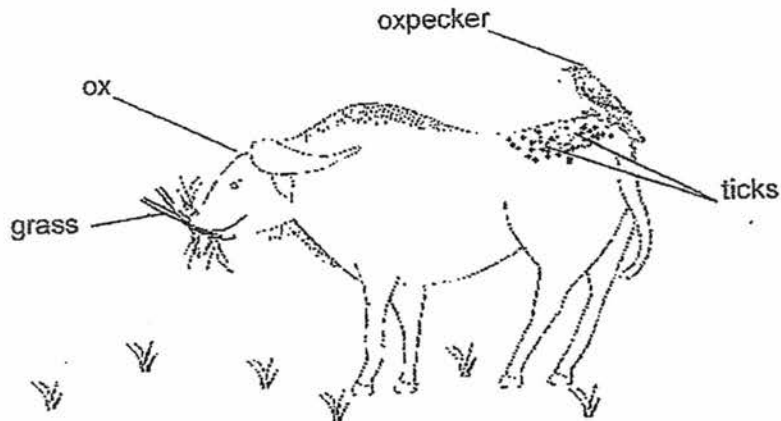

(a) What is the indirect source of energy for the ox? [1]

The bird on the ox's back is an oxpecker that feeds bot., on blood-sucking ticks living on the ox, and on blood from the ox's wounds.

(b) Identify a pair of predator and prey. [1]

(c) In the space below, draw a food web to show the feeding relationships of all the organisms above. [2]

- 33 The diagram below shows a sloth. The sloth is a mammal that lives in the trees of the rainforests.



Sloths are extremely slow moving. Their fur is often green as a plant-like organism called algae, grows on it. They climb down the tree to deposit their faeces in a hole they dig near the foot of the tree. They lose a quarter of their body weight when they pass out their faeces, which may be once every 6 to 8 days.

- (a) Suggest and explain an advantage to the sloths of each of the following:

(i) the algae that live in their fur

[1]

(ii) burying their faeces at the foot of the trees in which they live

[1]

- (b) One part of the sloth's digestive system is proportionally much bigger than the same part in humans. Suggest which part and give a reason for your answer. [1]

- 34 Ai Ling dipped two fingers into a dish of ice water. One finger was covered with petroleum jelly (made of oil). She timed how long she could keep the fingers inside the ice-cold water without feeling uncomfortable.

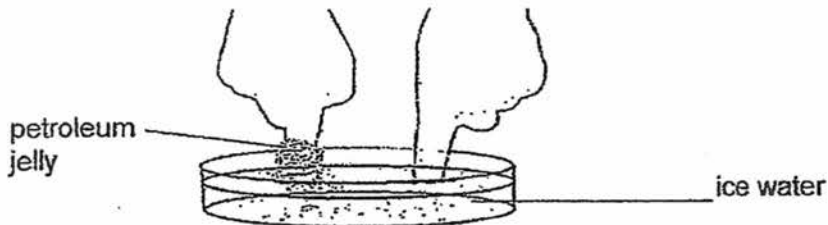

Her results are shown below.

	Time finger stayed in ice water
Bare finger	45 s
Finger with petroleum jelly	5 min

- (a) Why did her bare finger feel cold after a short while? [1]

(Question 34 continue on the next page)

Animal K is a large mammal that lives in cold regions. It has long hair, a compact body, short tail and small ears. It lives in herds and each herd can consist of over a hundred animals.



Animal K

- (b) Based on the results of Ai Ling's investigation, explain how the thick layer of fat under its skin helps Animal K. [1]

- (c) Identify a behavioural adaptation of Animal K to help itself keep warm. [1]

- (d) Besides the thick layer of fat and long hair, identify another structural adaptation that helps it survive in the cold. Explain your answer. [2]

- 35 Jeremy shone a torch on a piece of material Z. He placed 2 light sensor dataloggers of equal distance from the material Z as shown in the diagram below.

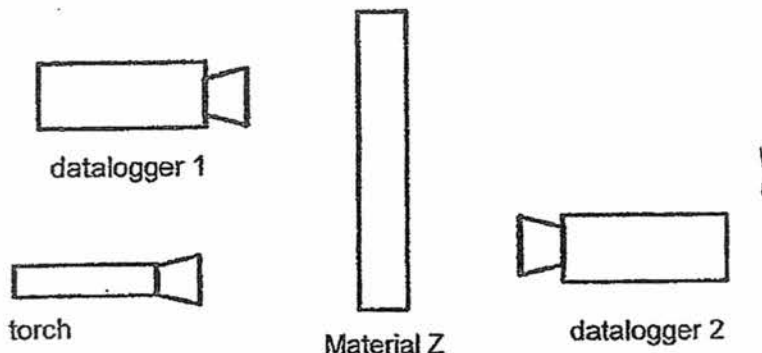

The table below shows the amount of light detected by the 2 dataloggers.

Datalogger	Amount of light (lux)
datalogger 1	1000
datalogger 2	3000

- (a) What is the difference in the amount of light detected by the two dataloggers? [1]

- (b) Give a reason for the difference in the amount of light detected by the two dataloggers. [1]

- (c) Jeremy decided to use the material Z to build a greenhouse to grow his plants. Do you agree with him? Explain why. [1]

- 36 Zen prepared set-ups A, B and C as shown below. Equal volume of 3 different matters, gas, liquid and solid were placed in the test-tubes and heated for 10 minutes.

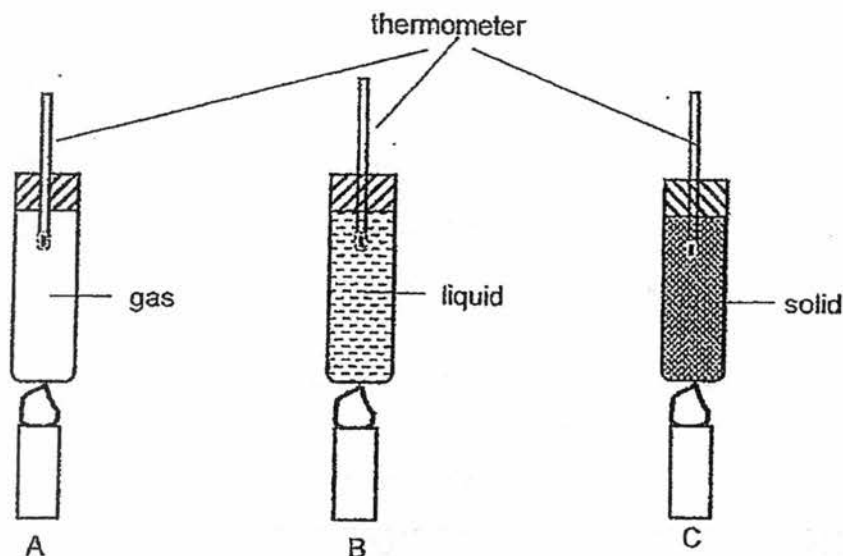

After 10 minutes, the changes in the temperature of the content in the test-tubes were recorded in the table below.

Time / minutes	Temperature (°C) of content in set-up		
	gas	liquid	solid
0	30	28	23
5	37	40	60
10	39	42	93

- (a) Based on the table above, what can you conclude about the rate of heat conductivity of the three states of matter? [1]

(Question 36 continue on the next page)

Mrs Ong made a pudding as shown in the diagram below.

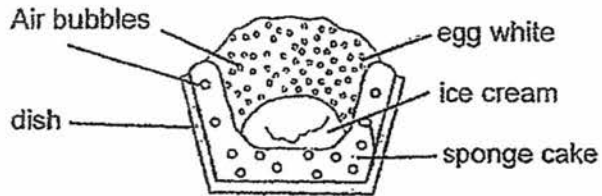

The pudding was put in a very hot oven until the top of the egg white turns brown. It is then removed from the oven. The ice cream remains frozen in the solid state when it is served.

- (b) Give a reason why the ice cream remains frozen in the solid state: [2]

- (c) What is the effect of heat gain for the egg white? [1]

- 37 Macy went to a restaurant for dinner. A soup was served in a paper pot on a stove as shown in the diagram below.

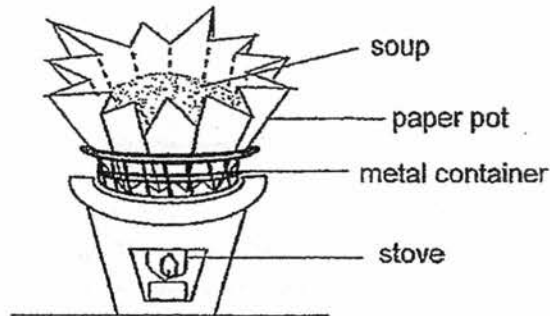

After 15 minutes, she observed that the soup boiled but the paper pot did not burn at all.

- (a) Why did the soup boil? [1]

Macy concluded that the soup helped to prevent the paper pot from being burnt.

- (b) Suggest what Macy should do and observe to confirm her conclusion. [2]

Do: _____

Observe: _____

- 38 Fog is formed when warm water vapour in the air rises and meet the cold surface of the fog net.

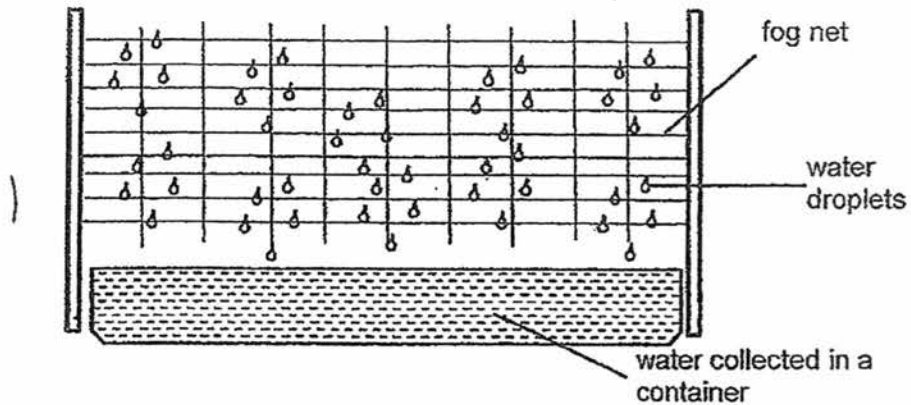

Water droplets that collect on the net run downwards and drip into a container at the bottom of the net from where they are collected and stored as freshwater for drinking.

- (a) Name the process that causes the water droplets to form on the net. [1]

- (b) In which habitat, desert or Arctic region would you use the fog net to obtain drinking water? Explain why. [1]

(Question 38 continue on the next page)

The table below shows the amount of fresh water collected per day by different sizes of fog nets.

Total surface area of net (m ²)	Amount of Water collected (litres/day)
50	1000
100	3000
150	5000
200	7000

- (c) State the relationship between the total surface area of the net and the amount of water collected per day. [1]

- (d) Besides the surface area of the fog net, state one other factor of the fog net that will affect the amount of water collected per day. [1]

- 39 A train making company is using wind turbines to produce energy to power the train in the country as shown in the diagram.

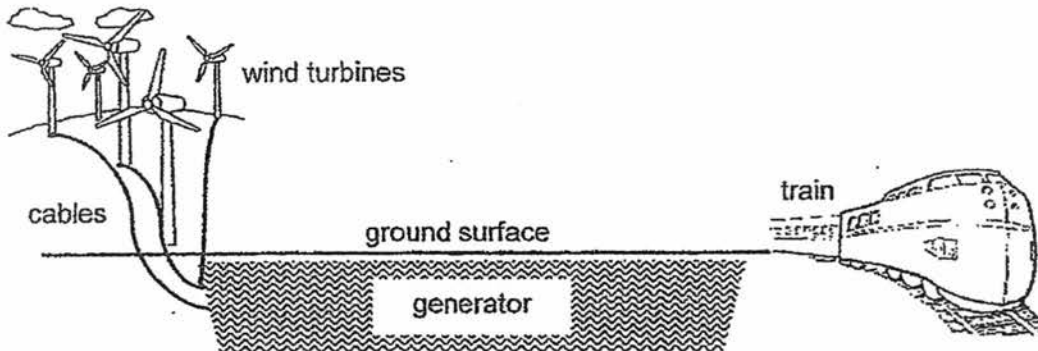

- (a) State the energy conversion to move the train. [1]

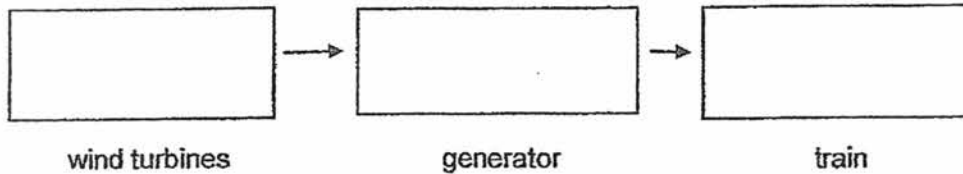

- (b) Give one advantage for wind as a source of energy to make the train move. [1]

- (c) The train company built many wind turbines to move the train. Explain why. [1]

- 40 An experiment was set up as shown in the diagram below. Three similar marbles were each placed on three similar ramps, A, B and C. Ramps B and C were painted with a different number of thick strips of white paint.

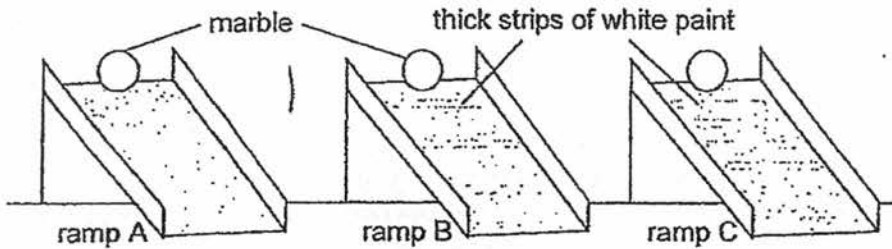

The three marbles were rolled down the ramps at the same time. The table below shows the average time taken by each marble to reach the bottom of the ramps.

Time (s)	Ramp A	Ramp B	Ramp C
Average	3.2	5.2	7.2

- (a) What is the possible aim of the experiment? [1]

- (b) What is the purpose of ramp A? [1]

- (c) Name the forces acting on the marble as they roll down along the 3 ramps. [1]

(Question 40 continue on the next page)

Study the picture below.

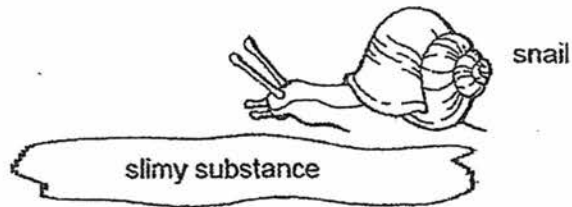

- (d) A snail secretes slimy substance as it moves along its path. Explain why. [1]

- (e) State one effect of friction the snail is trying to reduce by secreting the slimy substances. [1]

END OF PAPER

EXAM PAPER 2017 9 May 2017
 LEVEL : PRIMARY 6
 SCHOOL : RO SYTH
 SUBJECT : SCIENCE
 TERM : SEMESTRAL ASSESSMENT 1

Q1	Q2	Q3	Q4	Q5	Q6	Q7	Q8	Q9	Q10
1	2	3	4	4	2	3	1	1	1
Q11	Q12	Q13	Q14	Q15	Q16	Q17	Q18	Q19	Q20
4	4	4	4	2	2	2	2	4	4
Q21	Q22	Q23	Q24	Q25	Q26	Q27	Q28		
2	3	4	4	4	3	2	1		

Q29ai) Needs food to survive ii) reproduce iii) Grows

b) The reptile has dry scale but fish has wet scales.

Q30a) Cytoplasm

b)



c) I do not agree. The organism has chloroplast to make its own food with presence of sunlight.

Q31a) There is not enough space.

b) It is to allow the plants to carry out photosynthesis in order to make food.

c) When the leaves photosynthesise using carbon dioxide, oxygen is produced and oxygen is taken in and carbon dioxide is given out by the plant.

Q32a) The indirect source of energy for the ox is the sun as it allows the plants to make food in order to survive so the ox can eat the grass.

b) Ticks are predators and ox is the prey.

c)



Q33ai) The algae in the sloth's fur is to allow the sloth to camouflage among the trees to avoid being spotted by their predators.

ii) The faeces decay to provide nutrients for the tree so the tree will provide food and shelter for the tree.

b) Rectum. It can store a lot of faeces and only need to deposit their faeces once every 6 to 8 days.

Q34a) It lose heat to the ice water.

b) It help to reduce heat loss from the body to its surroundings.

c) They live in herds.

d) It has small ears. It reduces heat loss to the surroundings as the area exposed to the cold is reduced.

Q35a) The amount of light detected in the datalogger 1 is lesser than the datalogger 2.

b) The amount of light detected is lesser than the amount of light passing through.

c) Yes. As the material allows light to pass through it and plants are able to make food.

Q36a) The rate of heat conductivity for gas is the lowest but the rate of heat conductivity for solid is highest.

b) Air in the bubble is a poor conductor of heat so heat transfer from over to ice cream is slowed down.

c) It turns brown.

Q37a) It gained heat from the stove and it reached the boiling point.

b) do: Take to set ups, fill one with soup.
observe: the pot without soup will get burnt.

Q38a) Condensation.

b) Desert. The air in the desert will be hot while the water vapour in the Arctic is cold and the warm vapour will condense on the cold surface of the fog net.

c) As the total surface area of net increases, the total amount of water collected will increase.

d) The temperature of the fog net.

Q39a) Kinetic energy \rightarrow electrical energy \rightarrow kinetic energy

b) The wind is free.

c) Large amount of wind has more kinetic energy which can be converted to more electrical energy to move the train.

Q40a) To find out if the number of strips of the ramps affects the time taken for the marbles to reach the ground.

b) It acts as a control set-up to confirm that the only variable affecting the average time taken for the marble to roll down the ramp is the amount of thick strips of white paint.

c) Frictional force and gravitational force.

d) It is to reduce the amount of friction between the snail and its pat.

e) Wear and tear

1