



RAFFLES GIRLS' PRIMARY SCHOOL

SEMESTRAL ASSESSMENT (1)
2017

Name : _____ Index No: _____ Class: P6 _____

9 May 2017

SCIENCE

Attn: 1h 45min

Section A	56
Section B	44
Your score out of 100 marks	
Parent's signature	

SECTION A (30 X 2 marks)

For each question from 1 to 30, four options are given. One of them is the correct answer. Make your choice (1, 2, 3 or 4). Shade the correct oval on the Optical Answer Sheet.

1. Organisms W, X, Y and Z are classified using the chart below.

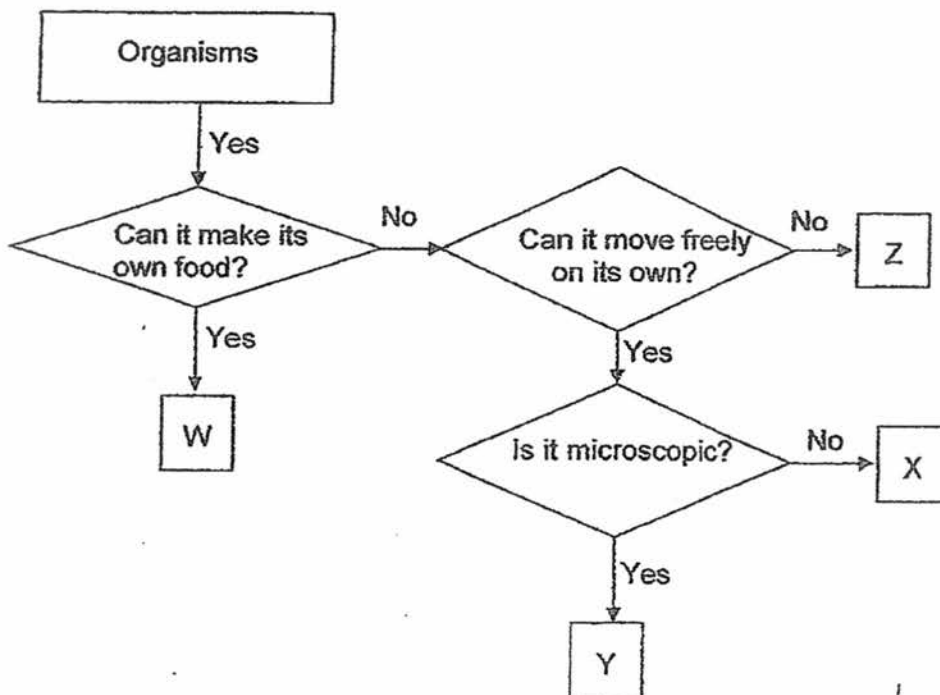

Which organism is most likely a fungi?

- (1) W
- (2) X
- (3) Y
- (4) Z

2. Which of the following characteristic(s) can be used to differentiate between fish and reptile?

- A Method of breathing
- B Type of body covering
- C Method of reproduction

- (1) A only
- (2) B only
- (3) A and C
- (4) B and C

3. Mary classified a group of animals in the table as shown below.

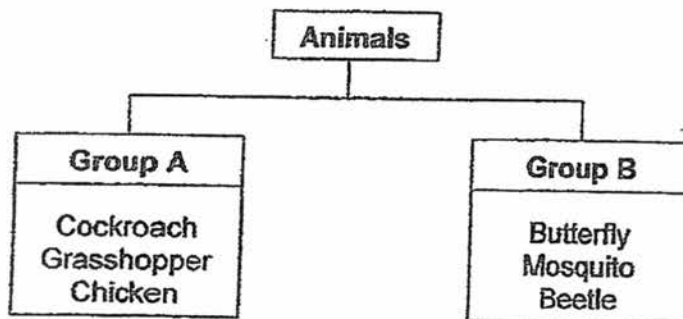

What characteristic of the animals was used by Mary in her classification?

- (1) Ability to fly
- (2) Number of legs
- (3) Place where the eggs are laid
- (4) Number of stages in its life cycle

4. Helen prepared four set-ups, P, Q, R and S, as shown in the table below.

Set-up	P	Q	R	S
Variables				
Number of green bean seeds	10	5	5	5
Amount of water added to the seeds everyday (cm ³)	100	100	0	100
Location where the set-up is placed	garden	garden	garden	freezer

Helen selected the following set-ups for each of the following experiment. Which of the following set-ups used will ensure a fair test?

	Set-ups	Aim of experiment
A	Q and R	To find out if water is needed for germination
B	P and S	To find out if the presence of warmth affects germination
C	P and Q	To find out if the number of seeds affects the rate of germination
D	R and S	To find out if the amount of water and presence of warmth affects germination

- (1) A and C only
- (2) B and D only
- (3) A, C and D only
- (4) A, B, and C only

5. The diagram below shows Siti's family tree. Some of Siti's family members have attached earlobes while some have detached earlobes.

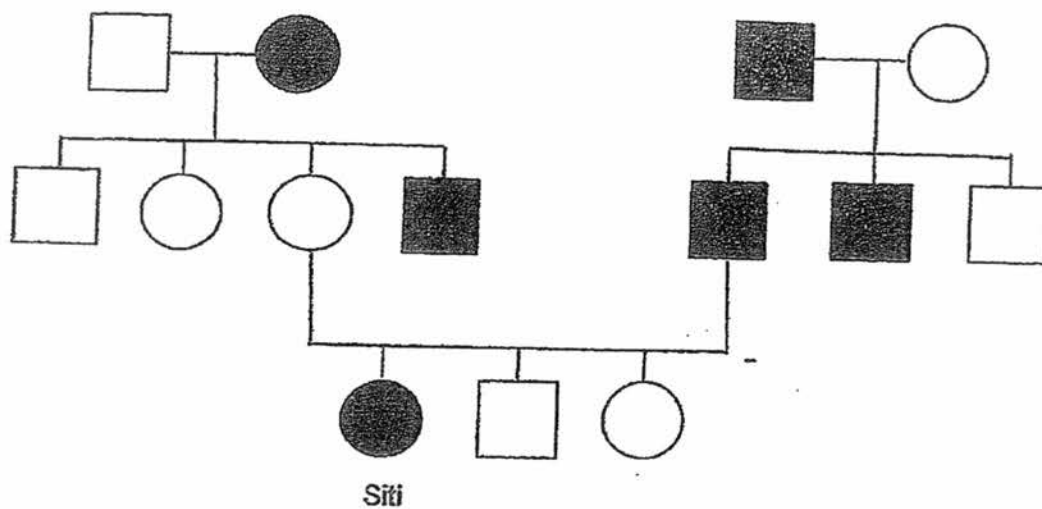

Legend:



Male with attached earlobes



Male with detached earlobes



Female with attached earlobes



Female with detached earlobes

Which one of the following statements is correct?

- (1) Siti's brother has attached earlobes.
- (2) Siti's parents have attached earlobes.
- (3) Both Siti's grandmothers have attached earlobes.
- (4) Siti's father has a brother with detached earlobes.

6. The diagram below shows the cross-section of a flower.

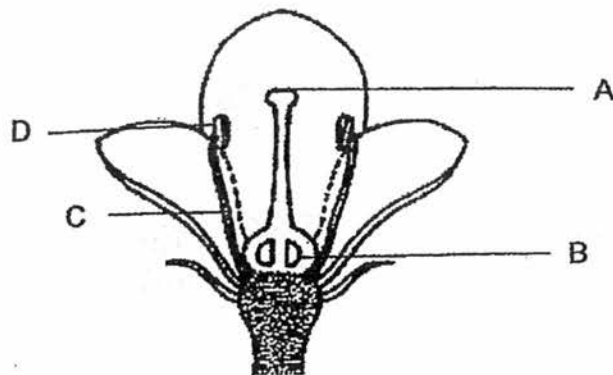

Which parts of the flower show where the pollen grains and ovules are produced?

	Pollen grains	Ovules
(1)	A	B
(2)	A	C
(3)	C	D
(4)	D	B

7. The diagram below shows parts of the digestive and circulatory system of a human.

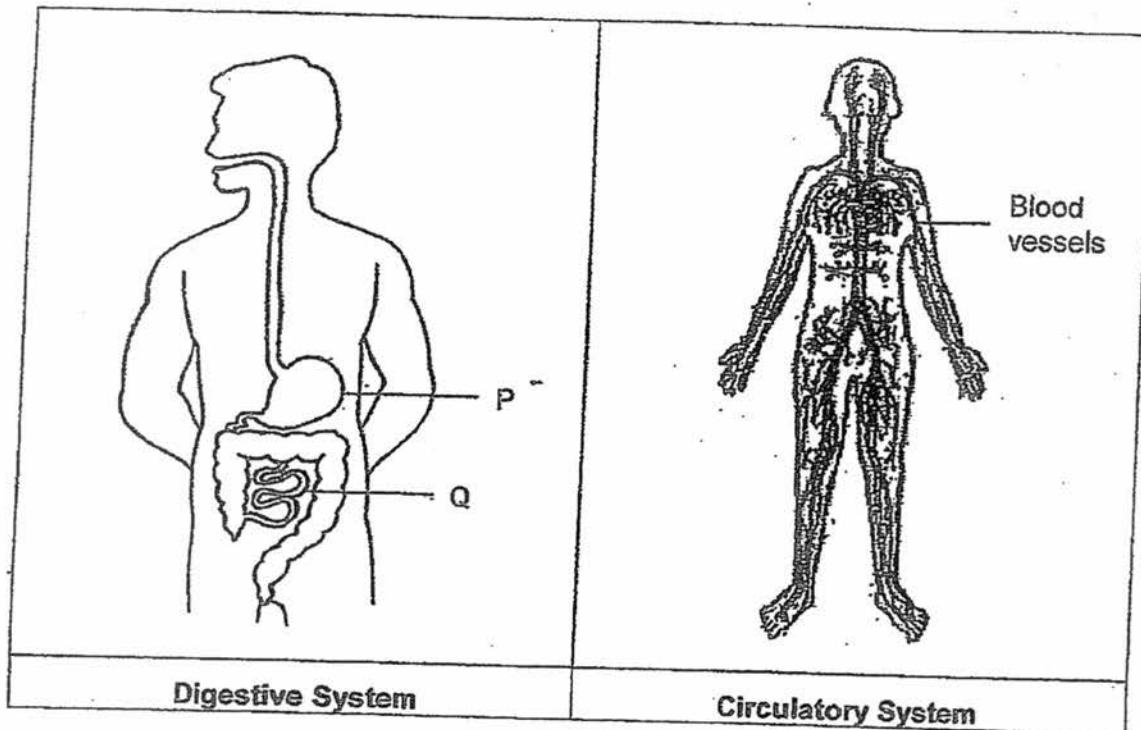

Which of the following statement(s) about the system(s) above is/are correct?

- A Blood transports the undigested food from P to the large intestine.
 - B Digested food from Q enters the blood vessels and is transported to different parts of the body.
 - C The circulatory system transports carbon dioxide away from the different parts of the body.
- (1) C only
 - (2) A and B only
 - (3) B and C only
 - (4) A, B and C only

8. Xiao Hui removed the outer ring of the stem of a plant bearing white flowers at X as shown in the diagram below.

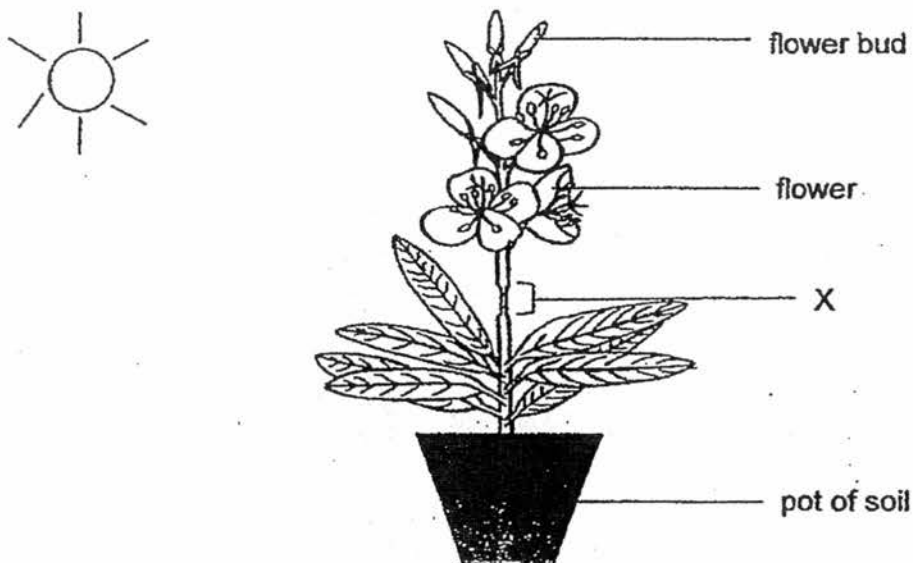

She left the plant under the Sun and watered it regularly with water stained with red food colouring.

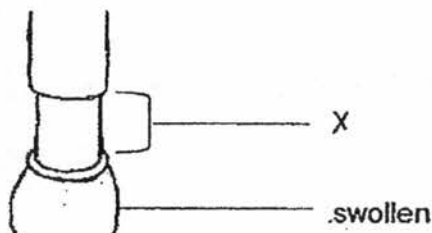

After a few days, Xiao Hui observed that the white flowers and flower buds were withering. However, the part of plant below part X was still alive and was observed to be swollen as shown in the diagram above. She also noticed that the leaves and stem below part X turned red, but not the part of the plant above part X.

Which of the following statement(s) explain(s) her observations?

- A The food-carrying tubes were removed at X.
 - B The water-carrying tubes were removed at X.
 - C The food made by the leaves was accumulated at the swollen part of the stem.
- (1) A only
 (2) A and B only
 (3) B and C only
 (4) A, B and C

The diagram below shows a cell with its parts labelled A, B, C and D.

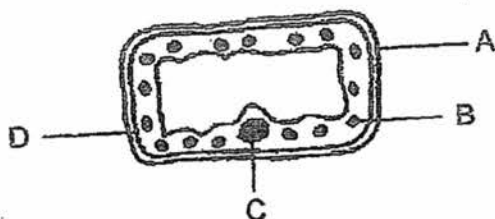

Which one of the following correctly describes the functions of parts A, B, C and D of the cell?

	Controls substances that enter or leave the cell	Controls all activities in the cell	Supports and gives the cell a rigid shape	Contains chlorophyll
(1)	A	B	D	C
(2)	D	C	A	B
(3)	C	B	A	D
(4)	B	D	C	A

10. The diagram below shows the direction flow of blood in a fish and flow of substances in a plant.

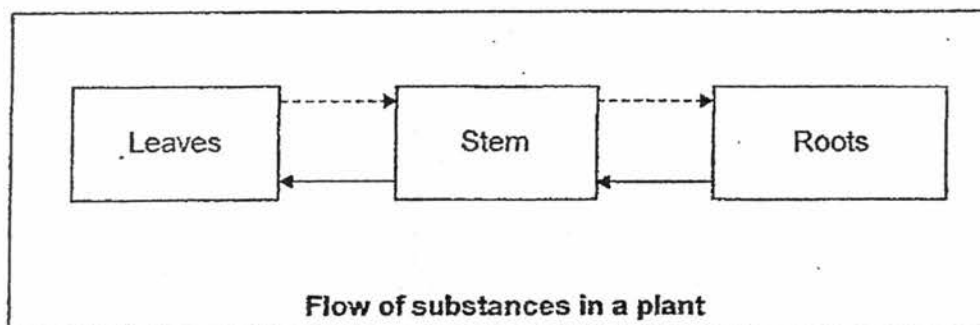
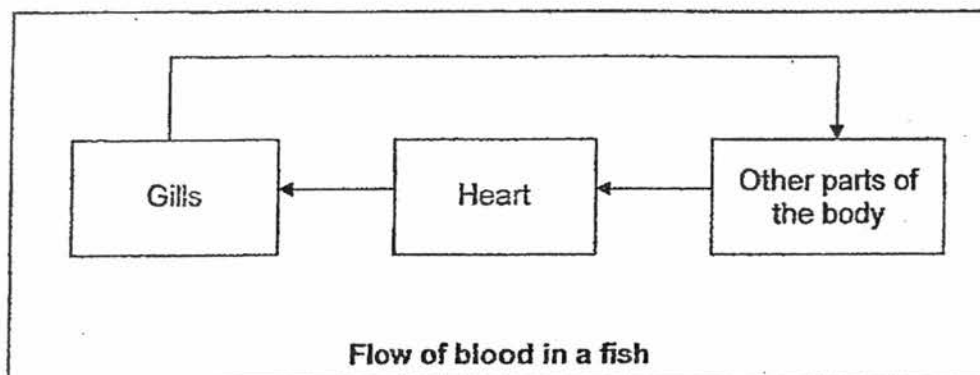

Which of the statements about flow of blood in fish and substances in plant are correct?

- A The plant removes water through the leaves and absorb water through the roots.
- B The plant allows food and water to flow at the same time in different directions
- C The flow of the blood in a fish and the flow of water in a plant moves in a circulatory direction.
- D Oxygen enters the blood vessels through the gills and carbon dioxide in the blood leaves the blood vessels through the gills.

- (1) A and B
- (2) A, B and C
- (3) A, B and D
- (4) A, B, C and D

11. Amy prepared four set-ups by putting identical amount of soil samples, A, B, C and D into each funnel as shown below.

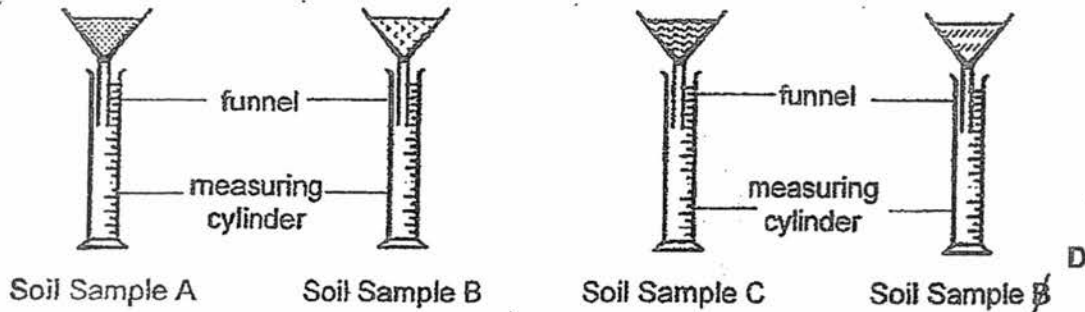

Amy poured 100 ml of water into the funnel of each set-up and recorded the amount of water collected in the measuring cylinders after two minutes in the table below.

Set-up with soil sample	Amount of water collected in the cylinder (ml)
A	60
B	20
C	95
D	80

Which one of the following soil samples, A, B, C or D, is able to hold the greatest amount of water?

- (1) A
- (2) B
- (3) C
- (4) D

12. Lillian conducted an experiment to investigate the effect of the amount of light on the growth of plant K over a period of time. She recorded her findings in the graph below.

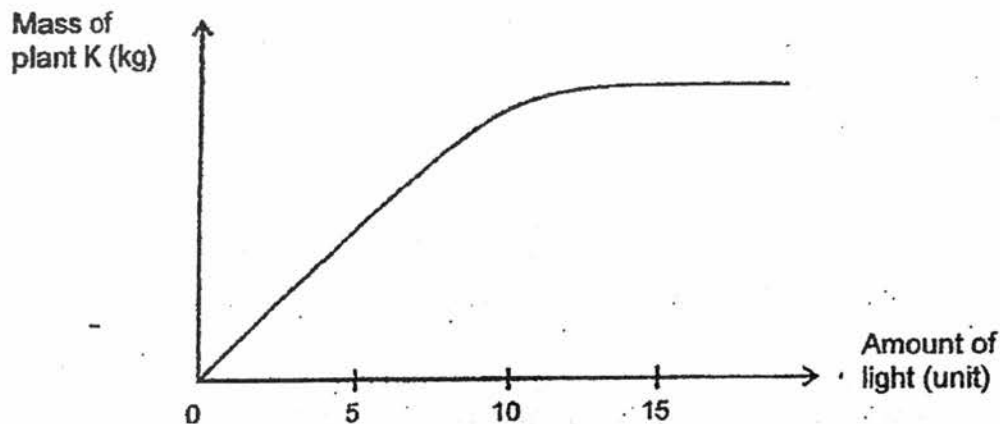

Next she also conducted another experiment on the effect of temperature of the surrounding air on the growth of Plant K over a period of time. The graph below shows the results of her experiment.

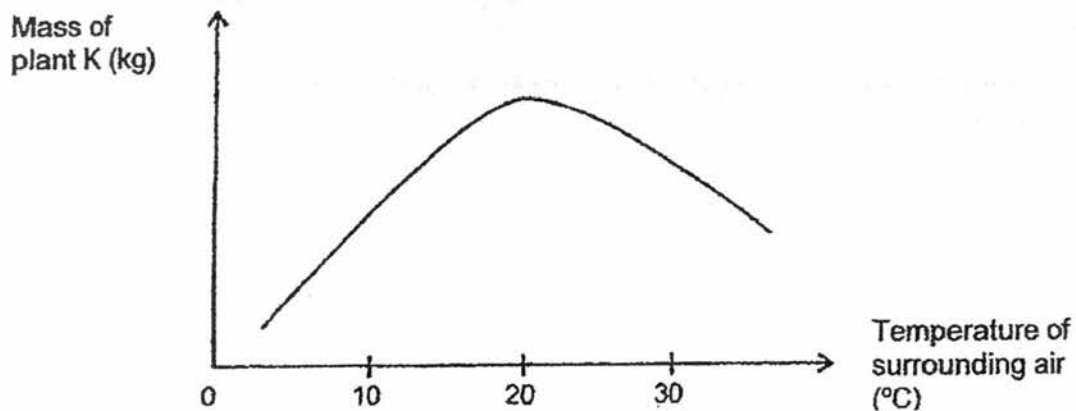

Based on the results above, which one of the following statements is definitely correct?

- (1) The ideal temperature for Plant K to produce the most food is 20°C
- (2) The higher the temperature of the surrounding air, the taller Plant K is.
- (3) As the amount of light increases, the temperature of the surrounding air decreases. ✕
- (4) In order for plant K to grow well, Lily needs to expose Plant K to surrounding air temperature of 30°C and 15 units of light.

13. Mavis carried out an experiment to study the decomposition of dead leaves. She placed some dried leaves in container as shown below and placed it in a cupboard.

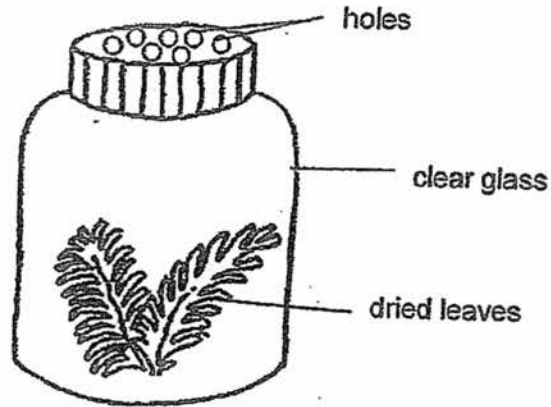

After 2 weeks, she noticed that no decomposition had taken place. What change(s) should she make to the set-up so as to speed up the rate of decomposition?

- A Add some water.
 - B Remove the lid.
 - C Add some caterpillars.
 - D Add more dead leaves
- (1) D only
(2) C and D only
(3) A and B only
(4) A, B and C only

14. The table below shows the description of some physical factors in four different habitats.

Habitats	A	B	C	D
Physical factors				
Humidity	high	high	low	Low
Average temperature (°C)	20	32	18	23
Light intensity (lux)	low	high	high	Low
Time taken for 25ml of water to flow through soil samples	21	16	13	8

Organisms Y prefer dark and damp places. They are most active when the surrounding temperature ranges from 20°C to 25°C.

Which of the following habitat(s) will most organism Y be found?

- (1) A only
- (2) D only
- (3) B and C only
- (4) A and B only

15. Fiona and her classmates counted the number of plants and animals found in a certain part of their school and recorded their findings in the graph shown below.

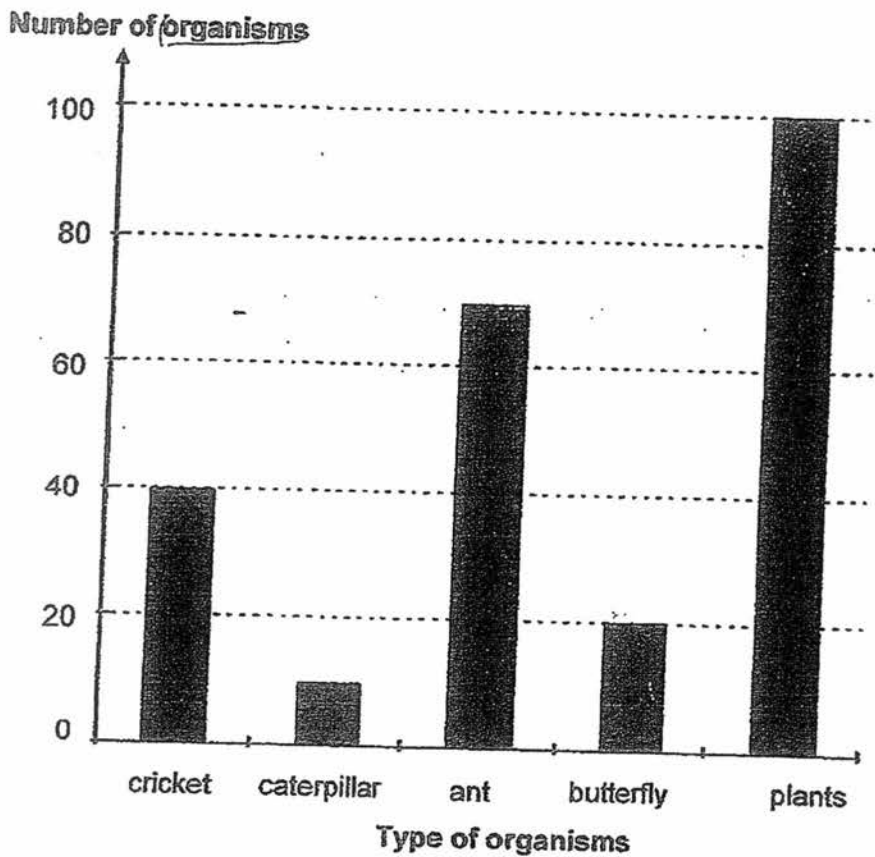

Based on the information above, which one of the following statements is/are definitely true?

- A The population of butterfly is the smallest.
- B The total number of populations in the habitat is 240.
- C The total number of populations in the habitat may be more than five.

- (1) B only
- (2) A and C only
- (3) A and B only
- (4) B and C only

16. Gary prepared two identical set-ups, X and Y, and placed them in the dark enclosed boxes for three days as shown in the diagrams below. Only the lamp in set-up X was switched on over the three days.

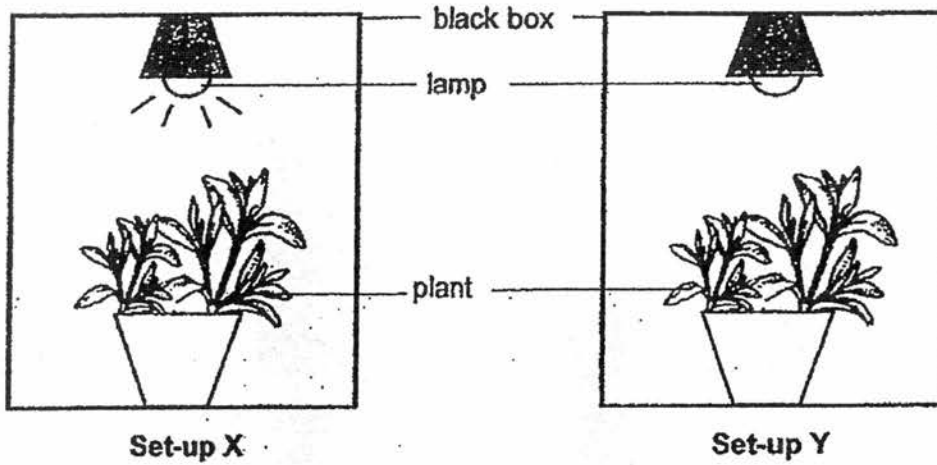

Which one of the following graphs shows the change in the amount of oxygen in the set-ups X and Y over the three days?

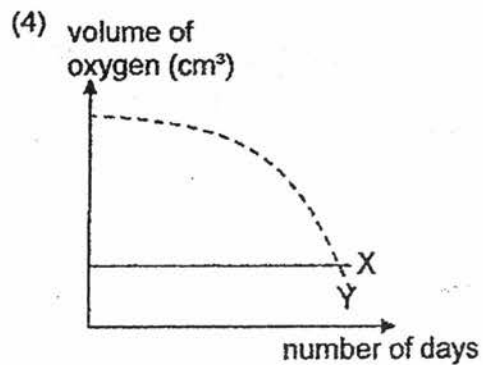
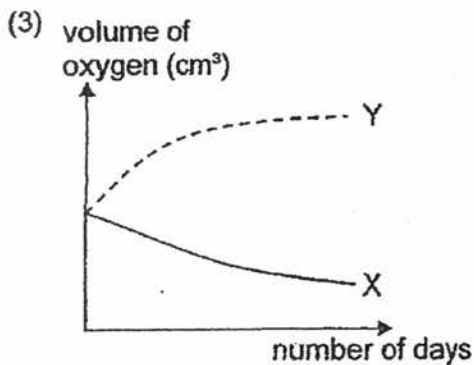
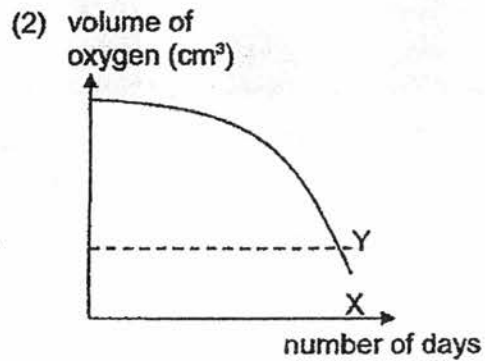
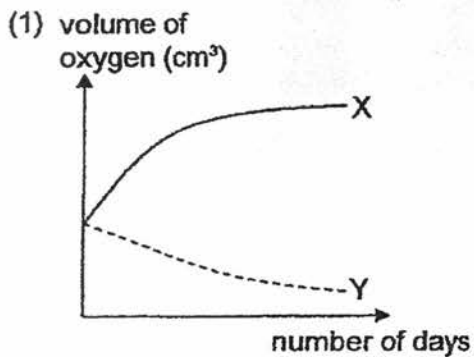

17. Material X is used to make the tyres of the truck as it will not break easily when the tyres roll over stones. It is able to wrap around the rims of the wheels. When it rains, water does not get into the tyres.

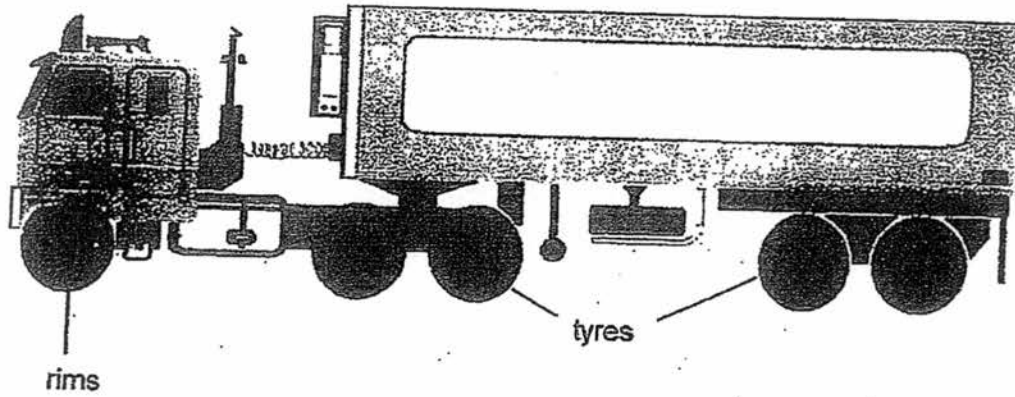

Based on the information above, which of the following are the properties of material X taken into consideration when used to make the tyres?

- A strong
 - B flexible
 - C waterproof
 - D able to float on water
- (1) A and B only
(2) A, B and C only
(3) A, C and D only
(4) B, C and D only

18. Two syringes, X and Y, contained substances A and B respectively. Plunger in syringe X could not be pushed in while plunger in syringe Y could be pushed in slightly as shown in the diagram below.

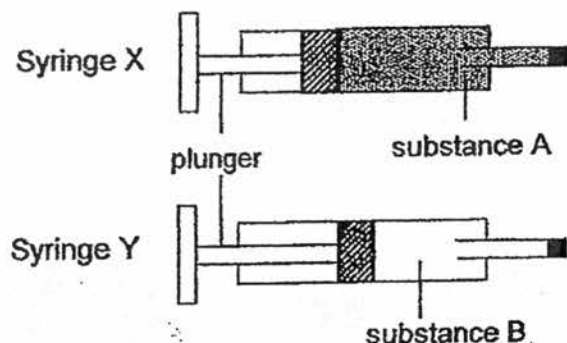

Which of the following statement(s) explain(s) the observations?

- A Substance A has definite volume.
- B Both substance A and B have mass.
- C Substance B can be compressed but not A.

- (1) C only
- (2) A and B only
- (3) A and C only
- (4) A, B and C

19. The table below shows the states of four substances, P, Q, R and S, at different temperatures.

State of substance at Substances	10 °C	40 °C	70 °C
P	solid	solid	solid
Q	solid	solid	liquid
R	solid	liquid	liquid
S	liquid	liquid	liquid

Which of the following statement(s) is/are correct?

- A The boiling point of substance R is 40°C.
- B The melting point of substance Q is 40°C.
- C Substance P has the highest melting point.
- D Substance S has a boiling point less than 10°C.

- (1) C only
- (2) A and D only
- (3) B and C only
- (4) A, B and D only

20. Study the four circuits W, X, Y and Z shown below.

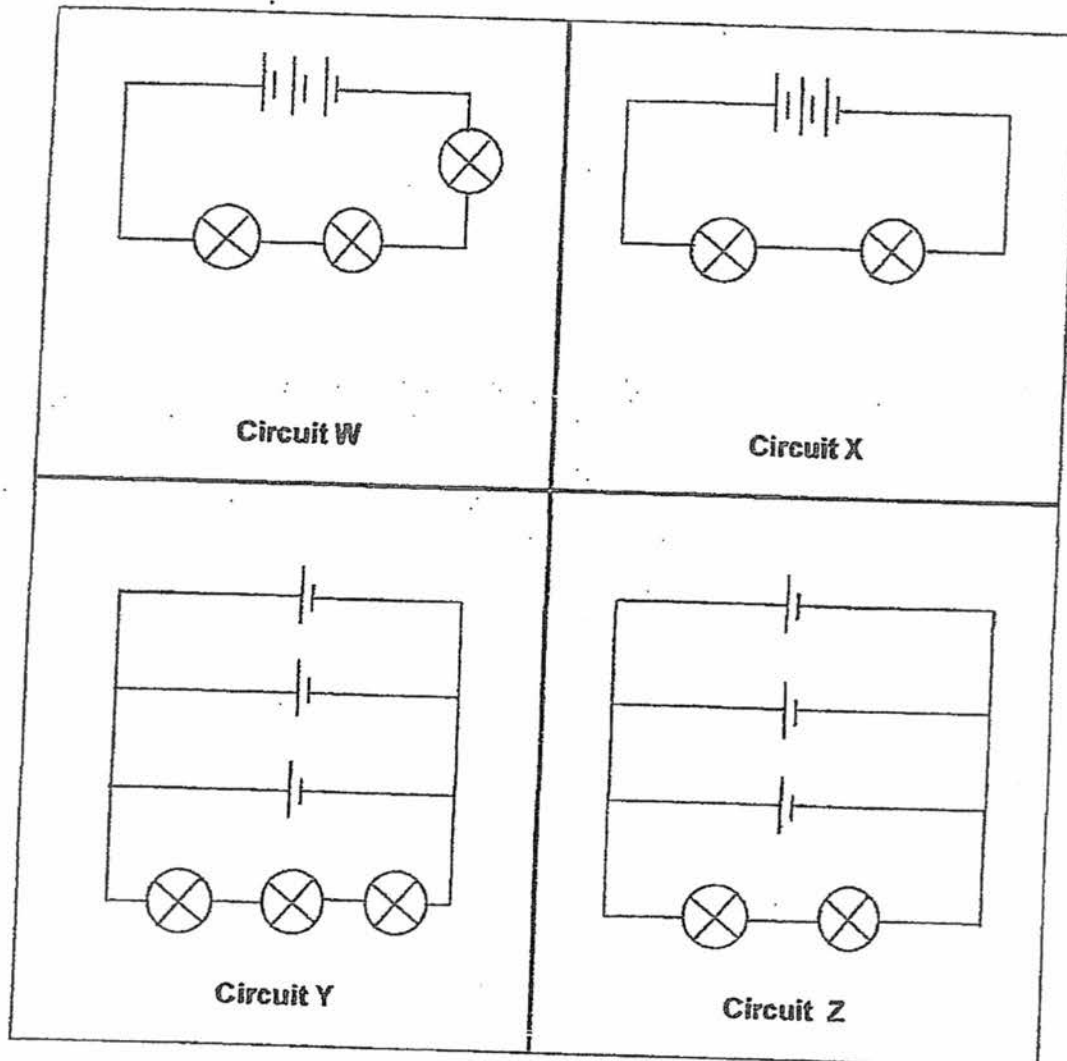

The bulbs and batteries in the circuits are identical and all the bulbs lit up.

Which one of the following statements about the brightness of the bulbs is correct?

- (1) The bulbs in circuit X are the brightest.
- (2) The bulbs in circuit Y is brighter than the bulbs in circuit Z.
- (3) The bulbs in circuit X is as bright as the bulbs in circuit Z.
- (4) The bulbs in circuit W is as bright as the bulbs in circuit X.

21. Ahmad had three materials, X, Y and Z. He placed them in positions, A, B and C, of the circuit shown below.

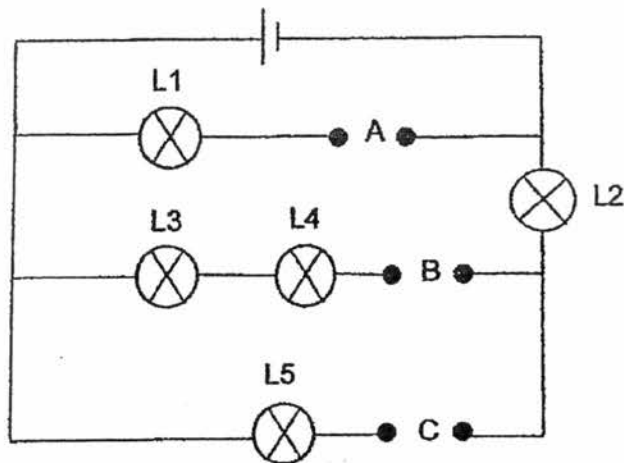

The results of the experiment were shown in the table below. When any of the lamps, L1, L2, L3, L4 or L5, lit up during the experiment, a tick (✓) was placed in the box.

Positions where materials were placed			Lamps				
A	B	C	L1	L2	L3	L4	L5
X	Y	Z	✓	✓	✓	✓	

Which of the following would show the correct result if the materials, X, Y and Z, were placed at different positions?

	Positions where materials were placed			Lamps				
	A	B	C	L1	L2	L3	L4	L5
(1)	X	Z	Y	✓				✓
(2)	Y	X	Z	✓		✓	✓	✓
(3)	Z	Y	X		✓	✓	✓	
(4)	Y	Z	X	✓	✓			✓

22. The set-up below shows four rings, A, B, C and D, which pass through a plastic rod.

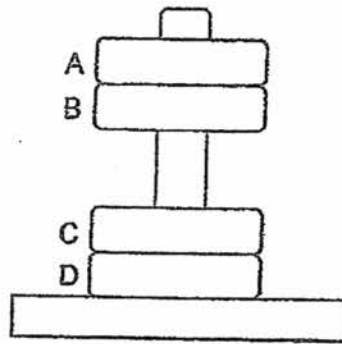

Which one of the following identifies A, B, C and D correctly?

	A	B	C	D
(1)	wood	magnet	steel	magnet
(2)	magnet	steel	wood	magnet
(3)	wood	magnet	magnet	steel
(4)	magnet	steel	magnet	wood

23. The canopies of parachutes, A, B and C were made of the same material but different sizes as shown below.

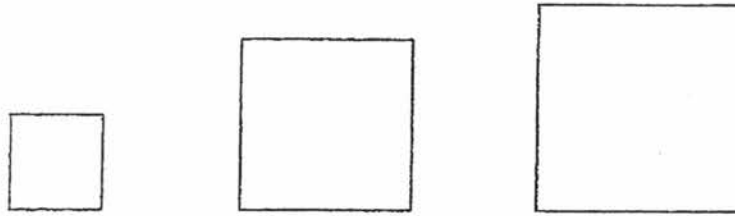

A 1-kg weight was tied to each parachute. The three parachutes were dropped at different heights above ground.

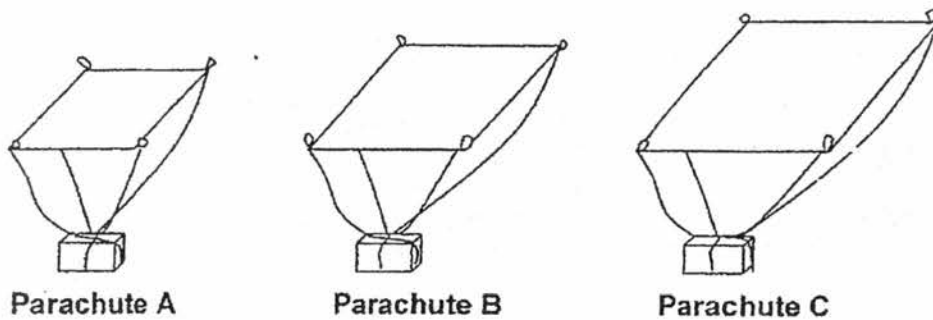

The parachutes were observed to reach the ground at the same time.

Which one of the following could possibly be the heights where parachutes A, B and C were dropped?

	Height for parachute (m)		
	A	B	C
(1)	3	1	2
(2)	1	2	3
(3)	2	3	1
(4)	3	2	1

24. Tom and his friends want to play a game of carrom. In the game, the carrom coins need to move over long distance on the carrom board easily.

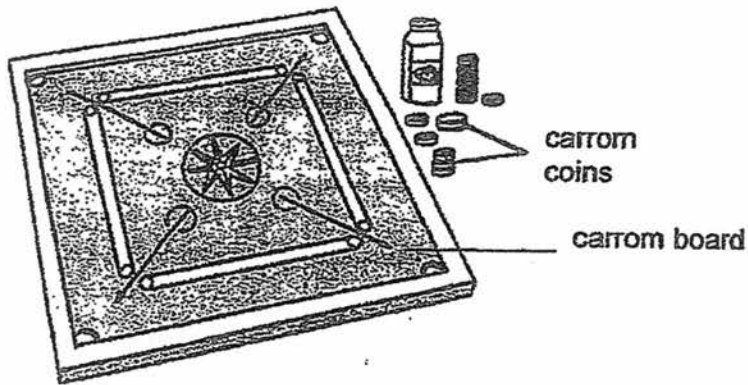

Which of the following should they do before playing the game so that the coins will move a longer distance on the board?

- (1) Spread powder on the surface of the carrom board.
- (2) Place a piece of rubber mat on the surface of the carrom board.
- (3) Paste sandpaper on the surfaces of the carrom coins that are in contact with the board
- (4) Scratch the surfaces of the carrom coins that are in contact with the board.

25. Mabel carried out an experiment in a dark room with the set-up as shown below. She arranged 4 sheets of the same size but of different materials K, L, M and N in a straight line.

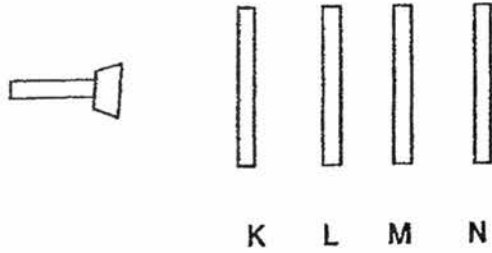

Circles of different sizes were cut out from sheet K and sheet L as shown in the diagrams below.

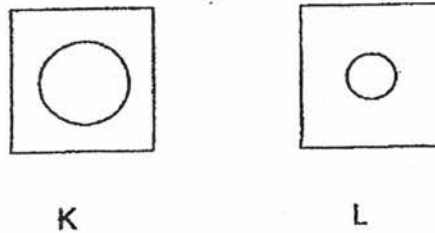

When the torch was switched on, she only observed a bright circular patch of light on sheet M.

Which one of the following is definitely true about the degree of transparency of the sheets used above?

	K	L	M	N
(1)	not possible to tell	opaque	opaque	transparent
(2)	transparent	transparent	not possible to tell	opaque
(3)	transparent	not possible to tell	opaque	transparent
(4)	opaque	transparent	opaque	not possible to tell

26. Wilson carried out an experiment using set-ups, A and B as shown below. The materials used in the set-ups were identical. The iron bars were positioned differently as shown below.

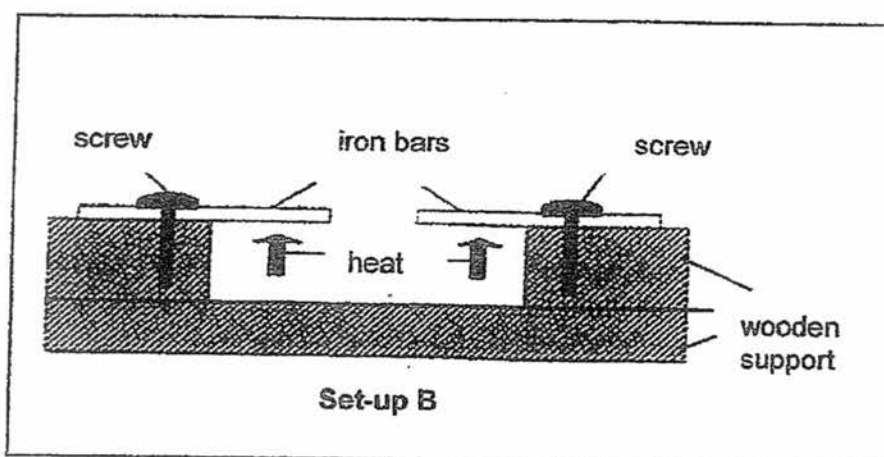
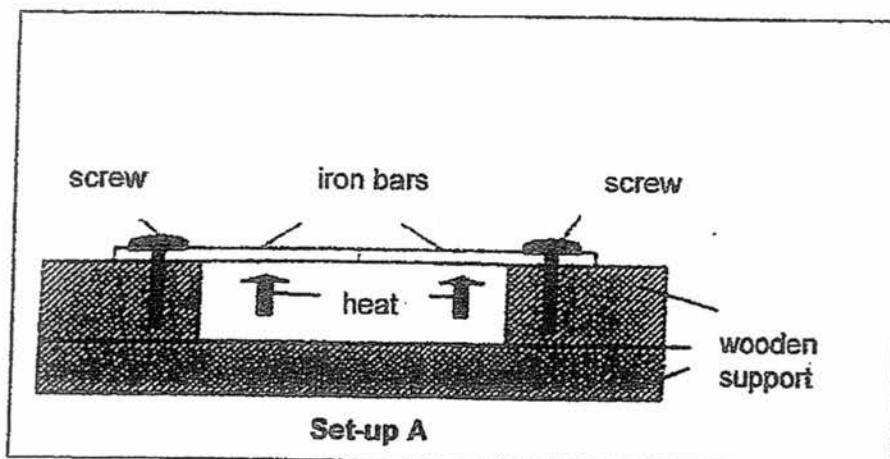



The iron bars attached firmly to a wooden support in both set-ups were heated for twenty minutes over high heat.

Which one of the following shows the correct explanations for his observations after twenty minutes?

- (1) The iron bars in set-up A bend due to expansion.
- (2) The iron bars in set-up A bend due to contraction.
- (3) The iron bars in set-up B bend as it expanded faster.
- (4) The iron bars in set-up B did not bend as the iron bars lose heat to the surroundings.

27. Jason, Timothy and Audrey were given the same amount of hot tea of the same temperature at the same time. Jason and Timothy poured their hot tea into a porcelain cup and saucer respectively and left them on the table for one minute before drinking the tea. While Audrey poured the hot tea between two identical porcelain cups repeatedly for one minute before drinking it as shown below.

	Before	After 1 minute
Jason	 Porcelain cup	Drank the tea from the cup.
Timothy	 Porcelain saucer	Drank the tea from saucer.
Audrey	 Porcelain cups Audrey poured the hot tea between the two porcelain cups repeatedly for one minute.	Drank the tea from one of the cups

Based on the information above, which one of the following statements is correct?

- (1) Timothy's tea in the cooled down fastest as the tea lost heat to the saucer the fastest.
- (2) The surface area of Audrey's tea exposed to the surrounding air is the greatest, hence the tea lost heat to the surrounding the fastest.
- (3) The surface area of the cup is the smallest, hence Jason's lips gain heat from the cup the slowest.
- (4) Audrey's cup of tea cooled down the slowest as the tea gained more heat from the surrounding air.

- 28 Hannah designed a doorbell as shown below. She attached the steel rod to a support so that the rod can swing freely. When the circuit is closed, she observed that the steel rod swing and hit the bell.

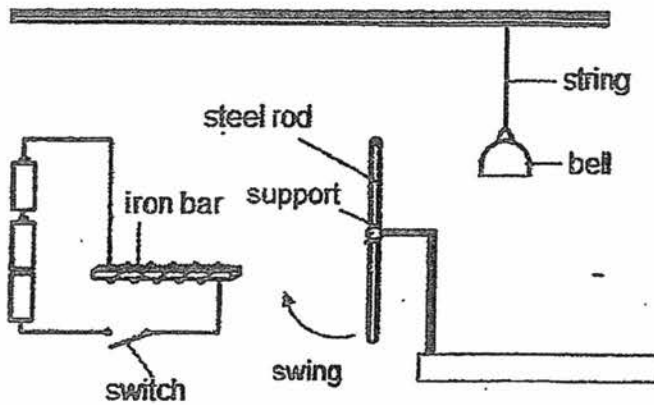

Which one of the following correctly describes the main energy conversion for the above observation?

	Energy in batteries	Energy in wires	Energy in steel rod	Energy in bell
(1)	potential energy	electrical energy	sound energy	potential energy
(2)	electrical energy	kinetic energy	kinetic energy	sound energy
(3)	electrical energy	electrical energy	electrical energy	kinetic energy
(4)	potential energy	electrical energy	kinetic energy	sound energy

Name : _____ Index No : _____ Class : P6

44

SECTION B (44 marks)

For questions 29 to 41, write your answers clearly in the spaces provided.

The number of marks available is shown in the brackets [] at the end of each question or part question.

29. Francis counted the number of wild plants P, Q and R on an island. After a few months, he noted down his observations in the diagrams shown below.

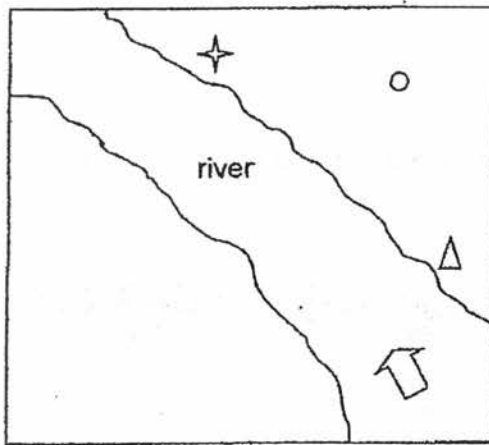
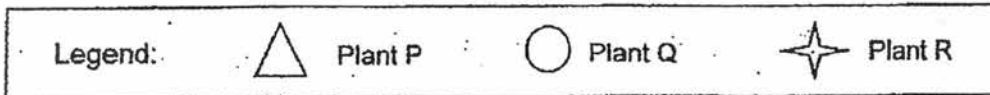

Before

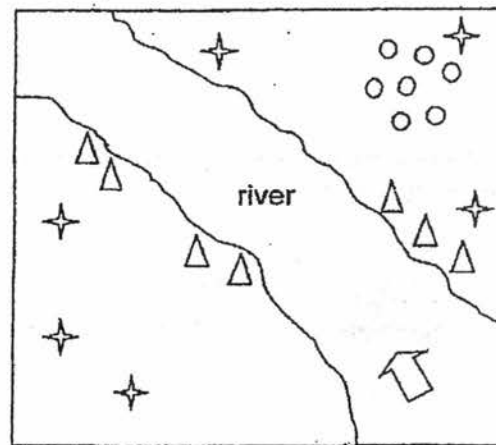

After

- (a) Based on the information above, state the method of seed dispersal for plants P, Q and R. [1]

(i) P: _____

(ii) Q: _____

(iii) R: _____

- (b) Based on the observation above, give a reason for your answer in (a)(i). [1]

Continue on next page

Score	2
-------	---

Continue from previous page

- (c) State one physical characteristic that plant P is likely to have that helps it in its seed dispersal. [1]

30. The diagram below shows the movement of substances in a plant.

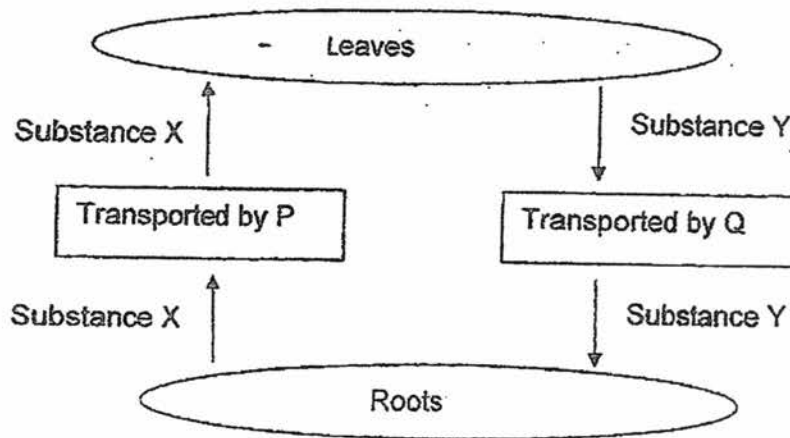

- (a) (i) Identify tubes P and Q in the stem of the plant. [1]

P: _____

Q: _____

- (b) (ii) Identify substances X and Y. [1]

X: _____

Y: _____

Continue on next page

Score	3
-------	---

Continue from previous page

30. The diagram shows the flow of blood in a human body.

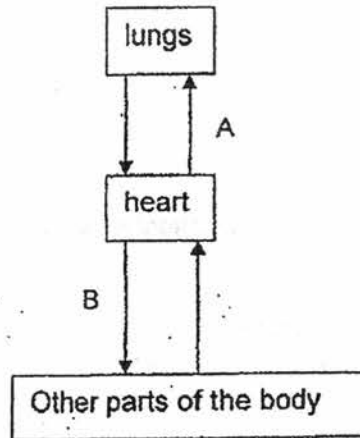

- (c) What is the difference between the composition of oxygen and carbon dioxide in the blood flowing at A and B? [1]

Score	1
-------	---

31. Study the food web of some organisms in a habitat below.

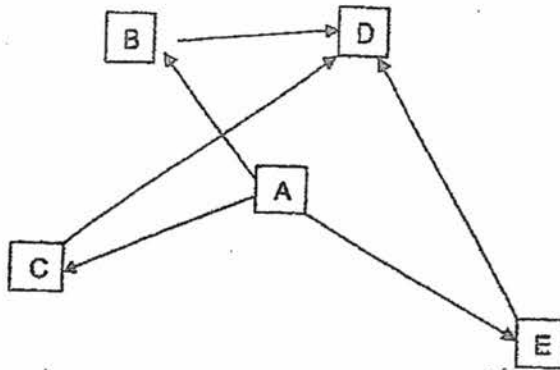

(a) Based on the food web above, use letters, A, B, C, D, ^{or} E or F, to identify the following: [2]

food producer(s)	
Predator(s) only	

(b) Based on the food web above, when there is a sharp increase in the population B, the number of C and E remained the same. How would the population of A and D change? Give a reason for your answer. [2]

(i) Effect of population A and reason:

(ii) Effect of population D and reason:

Score	4
-------	---

32. A farmer's crops had been destroyed by aphids. He wanted to find out which types of ladybirds, X,Y,Z, is most effective in getting rid of the aphids in his plantation.

He prepared the set-ups by placing 20 ladybirds and 200 aphids in each container. At the end of the experiment, the farmer recorded the number of aphids left in each set-up.

Set-up with	Number of aphids	
	Before	After
Ladybird X	200	194
Ladybird Y	200	107
Ladybird Z	200	48

- (a) Based on the results of his experiment, which type of ladybirds, X, Y or Z, should he use to get rid of the aphids most effectively?
Give a reason for your answer. [1]

Continue on next page

Score	/
-------	---

2017 P6 Science SA1

Continued from previous page

32 (b) The graph below shows the change in population size of the plants, aphids and ladybirds after the introduction of the ladybirds into the farmer's plantation over a period of time. There were no other organisms in this habitat.

Label the lines correctly using the words, 'plants', 'aphid' and 'ladybird' to show the change in population size over time. [3]

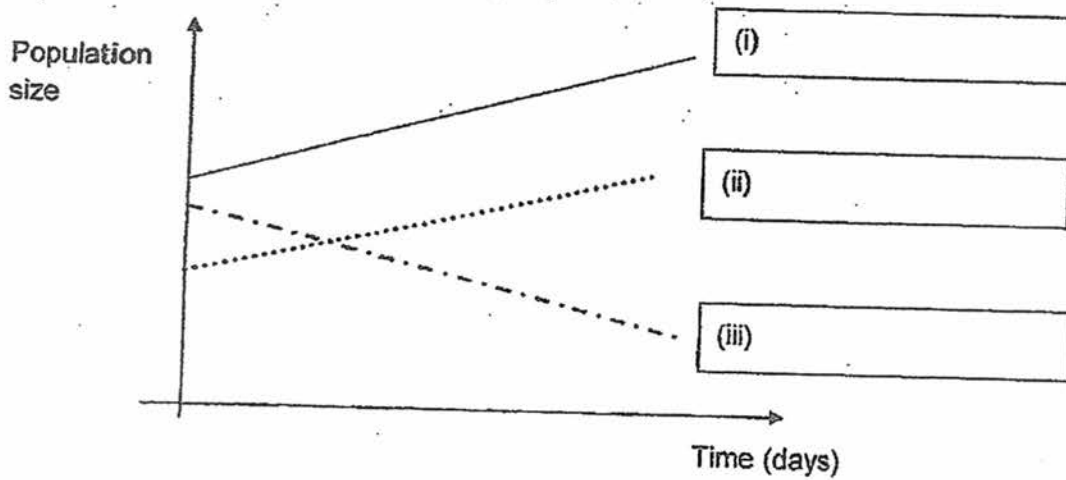

Score	3
-------	---

33. Dina prepared the following set-up and placed it in a dark room as shown below.

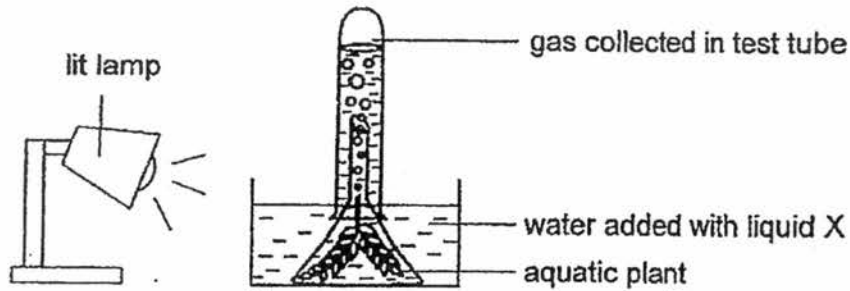

The water in the experiment was added with liquid X. Liquid X changes colour according to the concentration of carbon dioxide as shown in the table.

Amount of carbon dioxide in water	Less than normal	normal	Higher than normal
Colour of water with liquid X	purple	red	yellow

She observed the amount of gas collected in the test tube over three days and the change in the colour of water with liquid X and recorded her observations in the table below.

	Amount of gas collected in test tube (cm³)	Colour of water with liquid X
Day 0	0	yellow
After 1 day	3	red
After 2 days	5	purple
After 3 days	6	purple

- (a) Name the gas collected in the test tube. [1]

Continue on next page

Score	1
-------	---

Continue from previous page

- (b) Explain her observations made over the three days. [2]

- (c) State the relationship between the amount of carbon dioxide present and the amount of gas produced by the plant. [1]

Score	3
-------	---

34. The diagram below shows a water collecting device found in countries with little rainfall. The device was left in the open throughout the night. In the morning, tiny droplets of water were found on the mesh. There was no rain throughout the night.

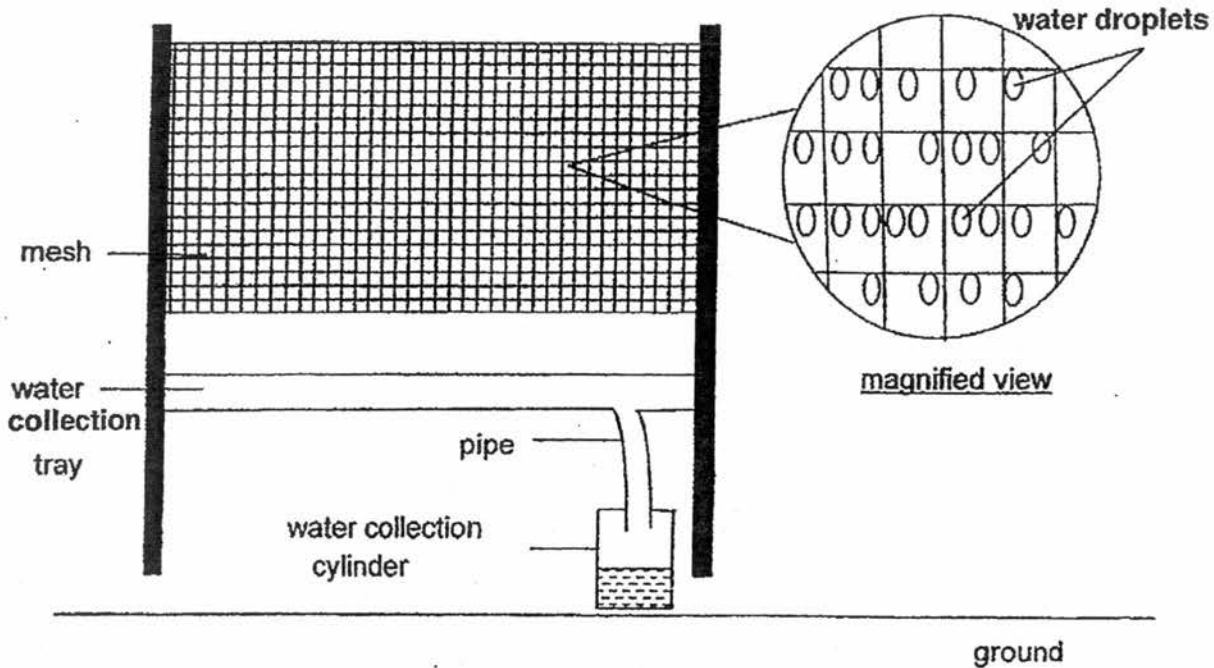

- (a) Explain how the water droplets were formed on the mesh. [2]

- (b) (i) In order to increase the amount of water collected, what can be done to the above set-up without changing the type of materials used in the device? [1]

- (ii) Give a reason for your answer in (b)(i). [1]

Score	4
-------	---

35. The wiring in Lynn's house was arranged as shown below.

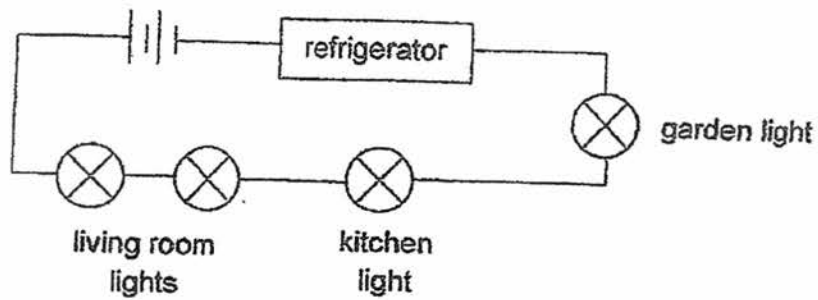

When the garden light was faulty and Lynn turned it on, she observed that the refrigerator and all the other lights would not work.

(a) How should Lynn arrange the wiring in her house such that if one bulb is not working, the refrigerator and other bulbs would still work?

Draw the electrical circuit diagram in the box below.

[2]

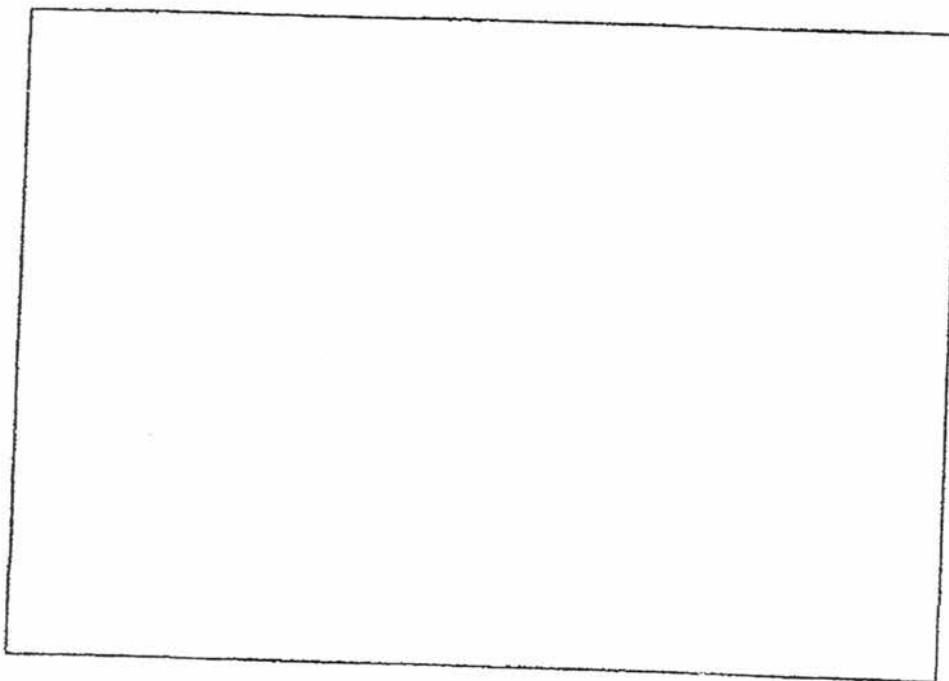

Score	2
-------	---

36. Jenny attached two bars on top of each toy car. She placed the toy cars 5 cm apart from each other as shown in the diagram below.

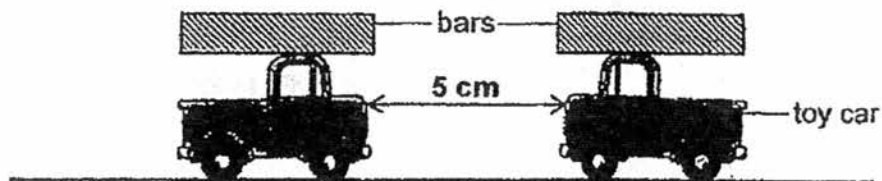

She noticed that the toy cars moved away from each other and ended up 10 cm apart from each other.

- (a) Based on the above observations, what could she conclude about the two bars placed on top of the toy cars? Give a reason for your answer. [2]

- (b) Without changing any objects used in the experiment, suggest what Jenny could do such that the toy cars could move from their original positions and ended up more than 10 cm apart from each other. [1]

Score	3
-------	---

37. Tom released a ball from the top of a ramp. He noticed that the ball rolled down the ramp, across the floor and stopped some distance from the ramp as shown in the diagram below.

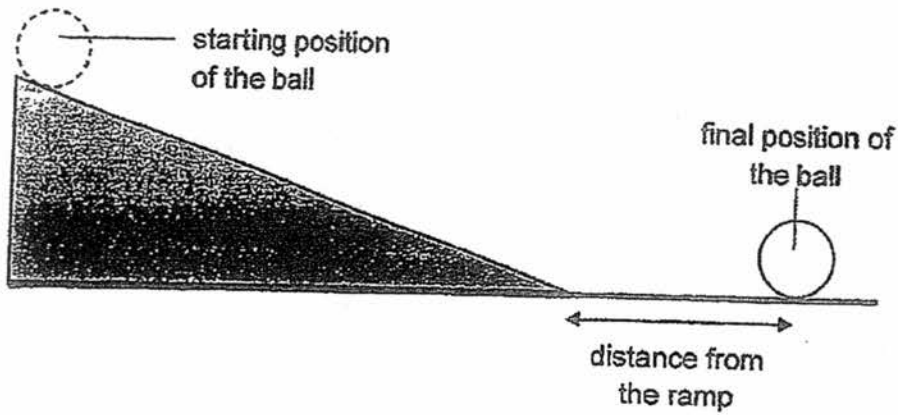

Tom measured the distance of the ball from the ramp and repeated the experiment but changed the surface of the ramp using different materials.

Material of the surface of the ramp	Distance from the ramp where the ball came to a stop (cm)
A	20
B	15

- (a) Explain the difference in the distance travelled by the ball on the ramp made of different materials. [1]

- (b) What can Tom do so that the ball moving on ramp with surface B could travel a longer distance without replacing any items from the set-up. Give a reason for your answer. [2]

Score	3
-------	---

38. Siti conducted an experiment on springs A and B. She hung various loads one at a time and recorded the length of the spring. Her results are shown in the graph below.

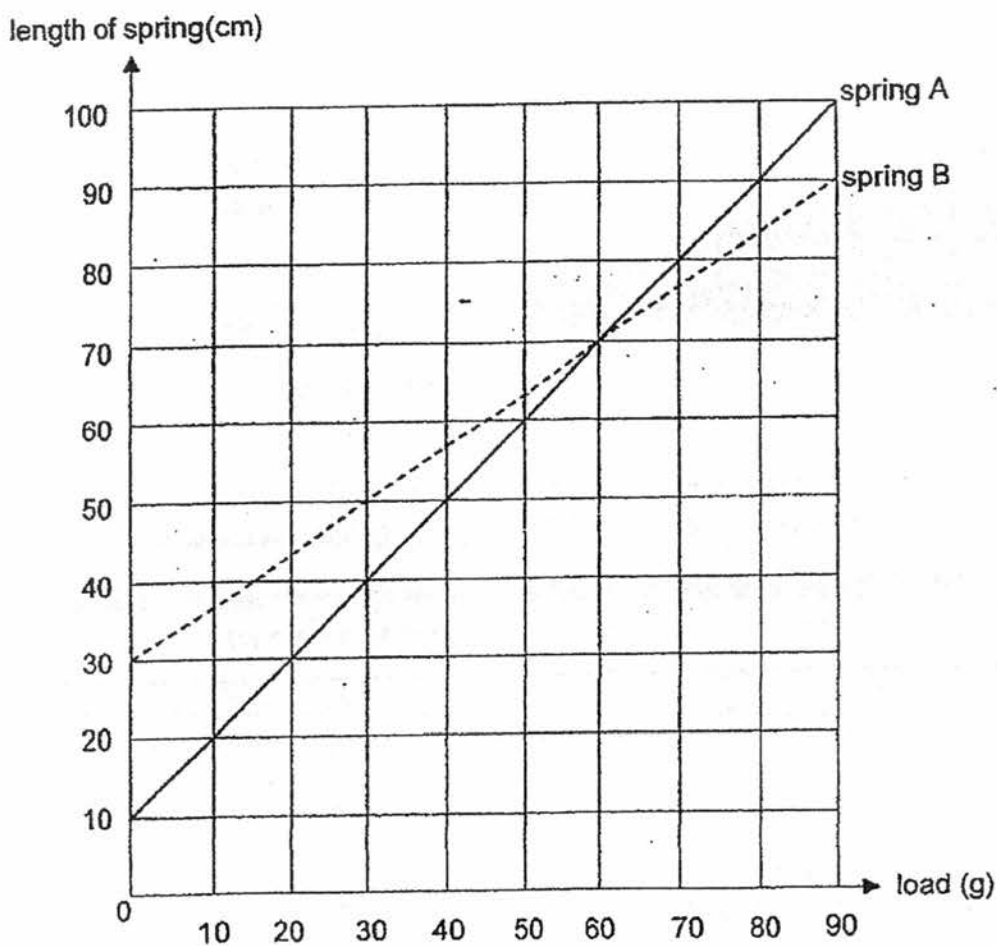

- (a) Name the force(s) that acted on the loads in this experiment. [1]
- _____
- (b) Which spring, A or B, is more elastic? Give a reason for your answer. [1]
- _____
- _____

Continue on next page

Score	2
-------	---

2017 P6 Science SA1

Continue from previous page

- (c) After Ali hung 100 g of load on spring A, he removed all the loads and observed that spring A was 20 cm long.

Give a reason for his observation.

[1]

Score	1
-------	---

39. Mabel used the ^{two} ~~three~~ wooden objects, ^{A and B} ~~A, B and C,~~ below in her experiment.

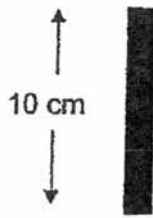

A

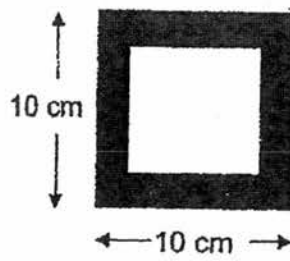

B

She hung the ² ~~3~~ wooden objects at different distances from the lighted torch as shown below.

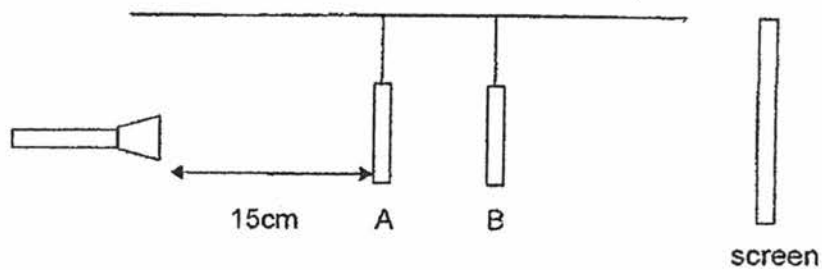

(a) In the box below draw the shadow of the objects Mabel would observe on the screen. [2]

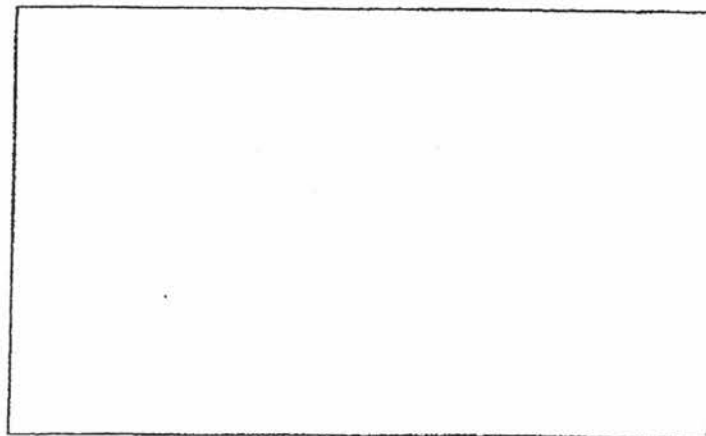

Continue on next page

Score	2
-------	---

2017 P6 Science SA1

Continued from previous page

(b) Explain how you arrive at your answer in (a). [2]

(c) Mabel moved the torch nearer to objects A and B.

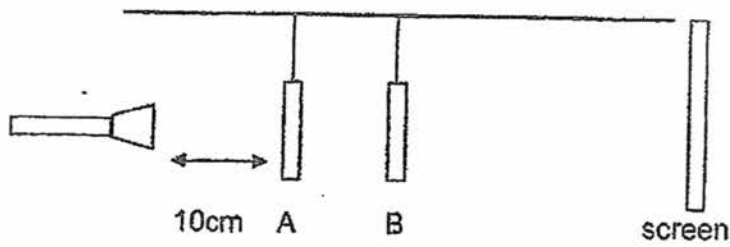

What change would she observe in the shadows formed on the screen? [1]

Score	3
-------	---

40. Sam heated three identical glass flasks containing 200 ml of water on materials X, Y, Z. He placed the three materials, X, Y and Z on the heater and positioned the three glass flasks containing 200 ml of water on each of the materials as shown below.

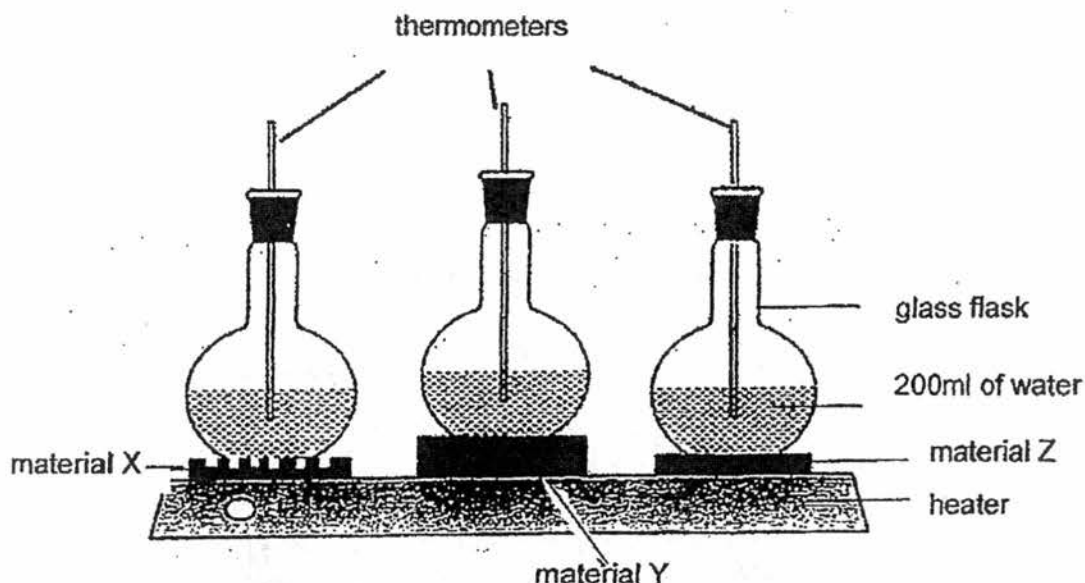

- (a) List two variables Sam must keep the same, in order to conduct a fair test. [2]

- (b) After making the changes to ensure his experiment was a fair test, Sam recorded the time taken for the water to boil as shown below

Material	Time taken for the water to start boiling (min)
X	4
Y	15
Z	8

- Based on Sam's results, which material, X, Y or Z would you use to make an ice box? Give a reason for your answer. [1]

Score	3
-------	---

2017 P6 Science SA1

Continue from previous page

(b) Explain your answer in (a).

[1]

(c) Describe what Johnson has to do to ensure that the data collected is reliable?

[1]

- END OF PAPER -

Setters : Mdm Lim L.S., Mrs C. Lim, and Mdm J. Woon.

45

Score	2
-------	---

2017 P6 Science SA1

41. Johnson set up the ramp below using five identical blocks.

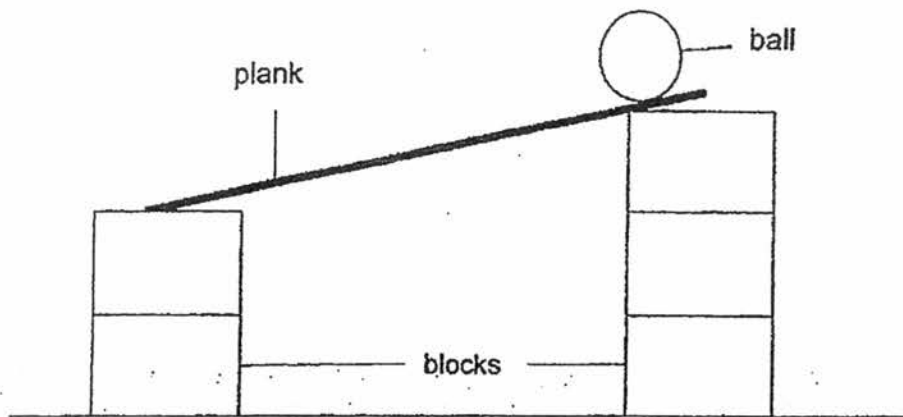

Johnson released the ball down the ramp. The time taken for the ball to roll down the ramp is approximately four seconds.

- (a) Johnson wanted to rearrange the five blocks such that the ball will roll down the ramp in less than four seconds.

Draw the new set-up using all the objects provided in the box below. [1]

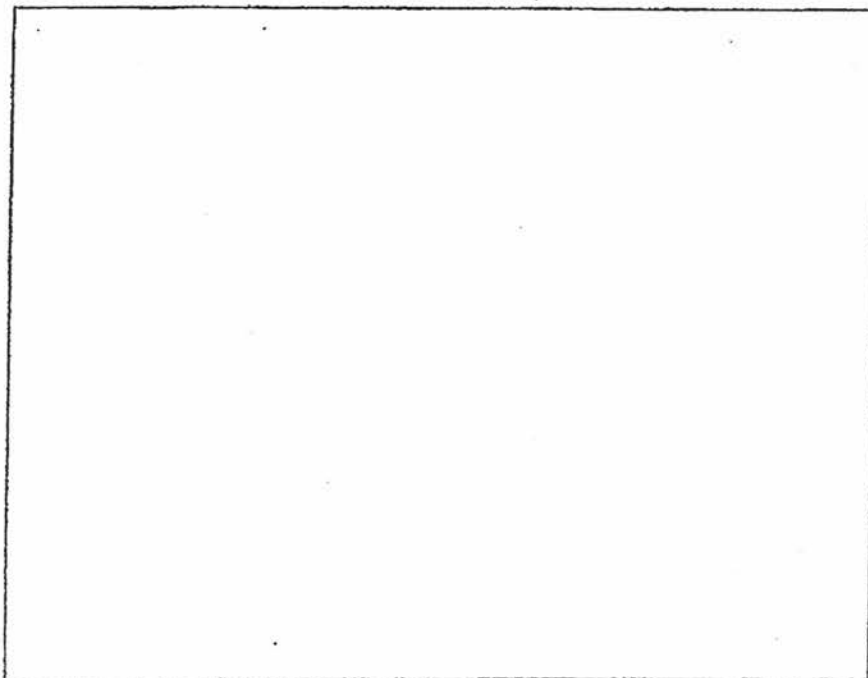

Continue on next page

Score	1
-------	---

YEAR : 2017
 LEVEL : PRIMARY 6
 SCHOOL : RAFFLES GIRLS' PRIMARY SCHOOL
 SUBJECT : SCIENCE
 TREM : SEMESTRAL ASSESSMENT (1)

SECTION A

Q1	Q2	Q3	Q4	Q5	Q6	Q7	Q8	Q9	Q10
4	1	4	1	4	4	3	4	2	3
Q11	Q12	Q13	Q14	Q15	Q16	Q17	Q18	Q19	Q20
2	1	3	1	2	1	2	3	1	1
Q21	Q22	Q23	Q24	Q25	Q26	Q27	Q28		
4	3	4	1	4	1	2	4		

SECTION B

- Q29. a) (i) By water
 (ii) By splitting / explosive action
 (iii) By animal / wind
- b) The plants P were found growing along / near / beside the river.
- c) . Fibrous husk
 . Water proof outer-covering
- Q30. a) (i) Water carrying tube / xylem
 (ii) Food carrying tube / phloem
- b) (i) Water
 (ii) Food
- c) The blood flowing at A is richer in carbon dioxide and poorer in oxygen than the blood in B.
- Q31. a) (i) A (arrows pointing outward only).
 (ii) D (arrows pointing towards only).
- b) (i) Population A would decrease as more B would feed on A.
 (ii) Population D would increase as D would have more food, B, to feed on.
- Q32. a) Z, the number of aphids left in the setup was the least / there was a greatest decrease
 In the number of aphids. (use superlative)
- b) (i) Plants (ii) ladybirds (iii) Aphids

- Q33. a) Oxygen
 b) The aquatic plant used carbon dioxide to carry out photosynthesis and produce oxygen.
 c) The smaller the amount of carbon dioxide, the smaller the amount of oxygen produced by the plant.
- Q34. a) The water vapour in the air lost heat and condensed on the cooler surface of the mesh to form tiny water droplets.
- b) (i) A larger amount of mesh can be used.
 (ii) The greater the surface area of the mesh, the greater the amount of water vapour that come in contact and lost heat to and condense on the mesh.

Q35.

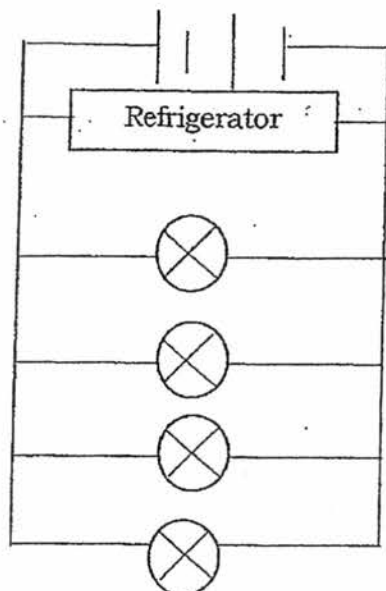

- Q36. a) The two bars are magnets. The like poles of magnet were facing other such that the Magnets repelled.
 b) Apply lubricant such as water on the ground.
- Q37. a) The ball travelled a longer distance on A as there is less friction between the surface A and the ball.
 b) Put oil, powder, water on the ramp. This will reduce the friction between the ball and Surface B.
- Q38. a) Gravity, elastic spring force.
 b) A. For the same amount increase in load, spring A increase more in length than B.
 c) Spring has been overstretched, reached its elastic limit.

Q39. a)

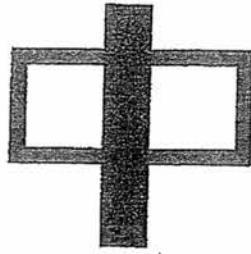

- b) A is nearer to the torch, hence the shadows is bigger.
- c) The shadows formed will be bigger.

Q40. a) (i) The thickness of material.
(ii) Initial temperature of water.

- b) Y. It is the poorest conductor of heat. It will take the longest time to conduct heat from surrounding.

Q41.

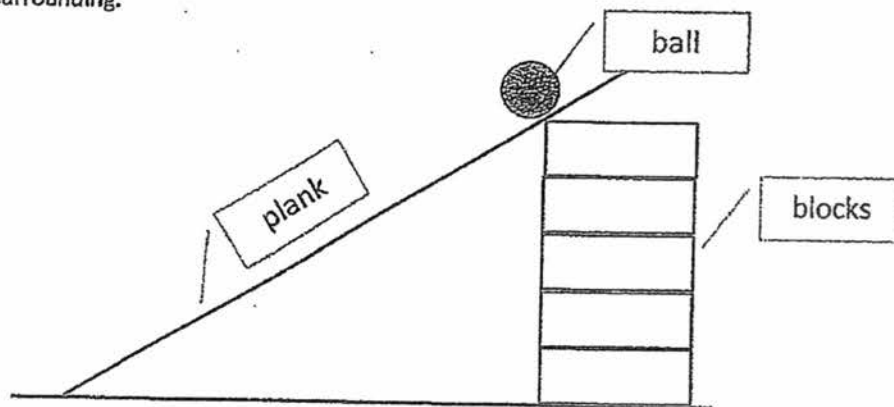

- b) The higher the ball is placed, the more GPE it has, hence more GPE is converted to more KE , resulting the ball roll down faster.
- c) Repeat the experiments 2 times and find the average time taken.