

Anglo-Chinese School (Junior)



SEMESTRAL ASSESSMENT 1 (2016)

PRIMARY 6

SCIENCE

BOOKLET A

Tuesday

10 MAY 2016

1 hour 45 minutes

Name: _____ () Class: 6.()

INSTRUCTIONS TO PUPILS

- 1 Do not turn over the pages until you are told to do so.
- 2 Follow all instructions carefully.
- 3 There are 30 questions in this booklet.
- 4 Answer ALL questions.
- 5 Shade your answers in the Optical Answer Sheet (OAS) provided.

This question paper consists of 21 printed pages (inclusive of cover page).

Booklet A (60 marks)

For each question from 1 to 30, four options are given. One of them is the correct answer. Make your choice and shade the oval (1, 2, 3 or 4) on the Optical Answer Sheet.

(60 marks)

- 1 Mrs Ang gave pictures of the following 4 living things to her pupils.



sunflower



dolphin



ostrich

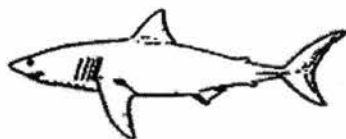

shark

The pupils grouped the living things into the classification chart below.

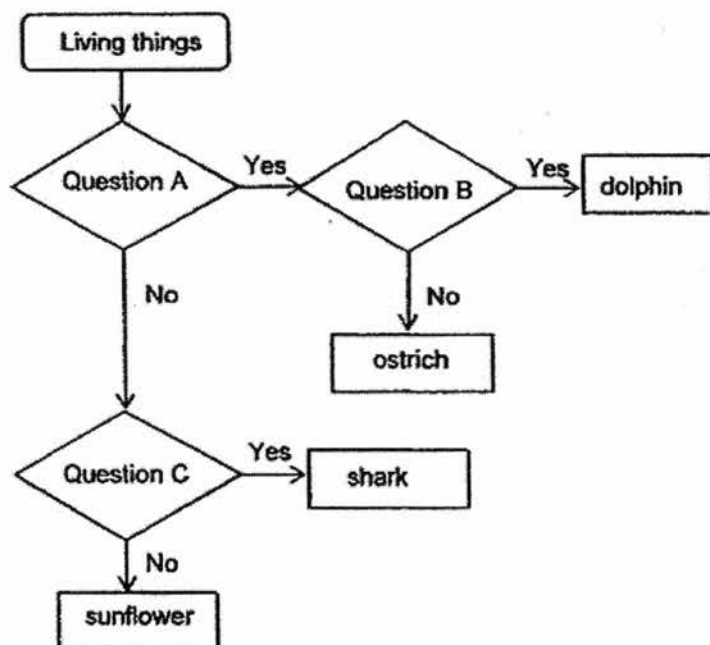

What were the three questions, A, B and C?

	A	B	C
(1)	Does it have gills?	Does it have lungs?	Does it live on land?
(2)	Does it have lungs?	Does it live in water?	Does it have gills?
(3)	Does it live on land?	Does it have gills?	Does it have lungs?
(4)	Does it live in water?	Does it have lungs?	Does it have gills?

- 2 The table below shows some characteristics of 2 animals, X and Y.

Characteristics	Animal X	Animal Y
It has a pupa stage in its life cycle.	Yes	No
The young moults several times.	Yes	Yes
The young looks like the adult.	No	Yes

Which set of animals below are likely to be X and Y?

	Animal X	Animal Y
(1)	Butterfly	Cockroach
(2)	Beetle	Mosquito
(3)	Butterfly	Beetle
(4)	Cockroach	Mosquito

- 3 The table below shows some characteristics of Kiran's parents.

Characteristics	Kiran's father	Kiran's mother
Has widow's peak	No	Yes
Has short hair	Yes	Yes
Has double eyelids	No	No
Has attached earlobes	Yes	No
Has short fingernails	Yes	No

Based on the information above, which of the characteristics are likely passed on from either of Kiran's parents to him?

- (1) Has widow's peak and attached earlobes.
- (2) Has double eyelids, short hair and attached earlobes.
- (3) Has short hair, attached earlobes and short fingernails.
- (4) Has widow's peak, double eyelids and short fingernails.

- 4 The diagram below shows a pump fitted to a container with a capacity of 300 cm^3 . It contains 100 cm^3 of water. When Kevin pushed the plunger of the pump in completely to pump air, it allows 15 cm^3 of air to enter the container.

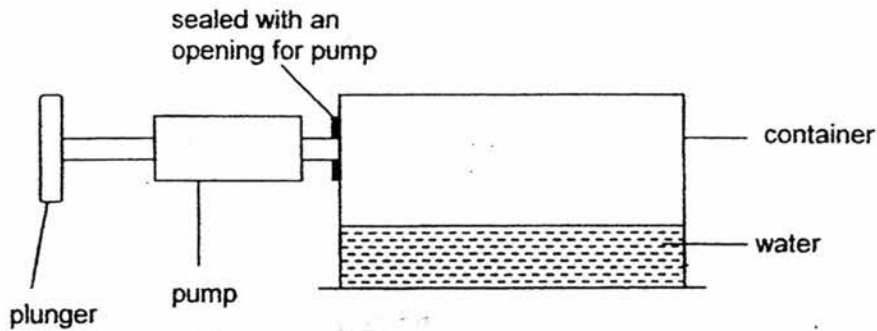

The plunger of the pump was pushed in completely 2 times. Which one of the following graphs correctly shows the volume of air in the container as air was pumped into the container?

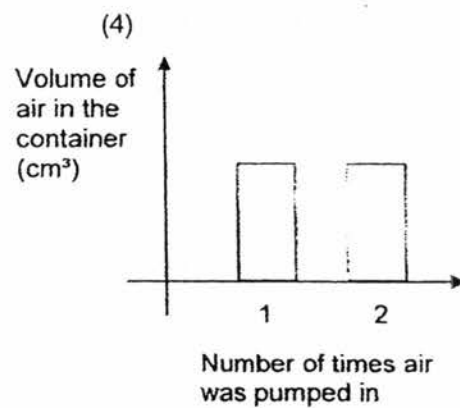
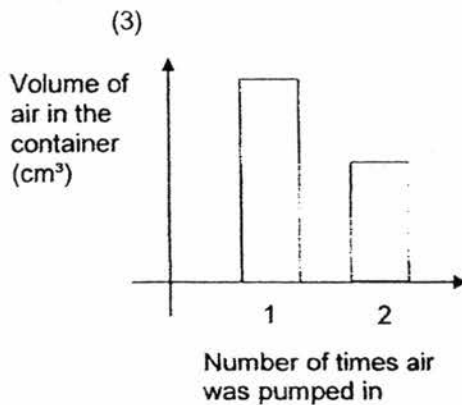
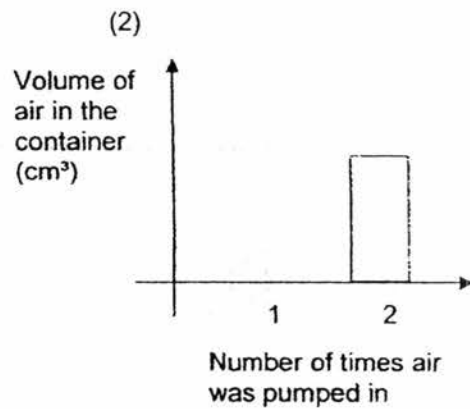
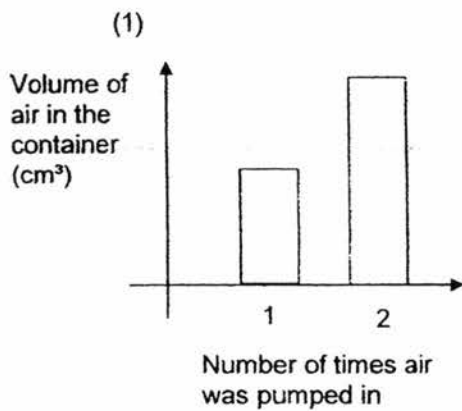



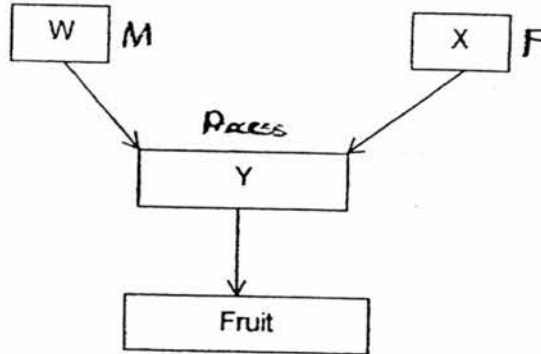

- 5 The following flowchart shows reproduction in flowering plants. W represents a male reproductive part and X represents a female reproductive part. Y represents a process in reproduction.



Which of the following is most likely W, X and Y?

	W	X	Y
(1)	Anther	Pollen grain	Pollination
(2)	Stigma	Anther	Pollination
(3)	Anther	Stigma	Fertilisation
(4)	Stigma	Pollen grain	Fertilisation

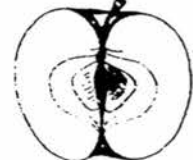
- 6 Charlotte found 4 different types of fruits, A, B, C and D, in a field. She searched the internet for more information on these fruits and recorded her findings in the table below.

			
Fruit A	Fruit B	Fruit C	Fruit D
Has wing-like structure	Dry, poisonous, has a bitter taste	Juicy, fleshy with small hard seeds	Has hooks and stiff hair

Which of the fruit(s), A, B, C or D, is/are most likely dispersed by animals?

- (1) C only
- (2) A and B only
- (3) C and D only
- (4) A, B, and D only

- 7 Kevin filled equal amount of liquid B and C into two identical glass bottles, P and Q, respectively. Liquid B and C are at different temperature. He sealed both glass bottles and left them on the dining table. After some time, he noticed water droplets formed as shown in the diagram below.

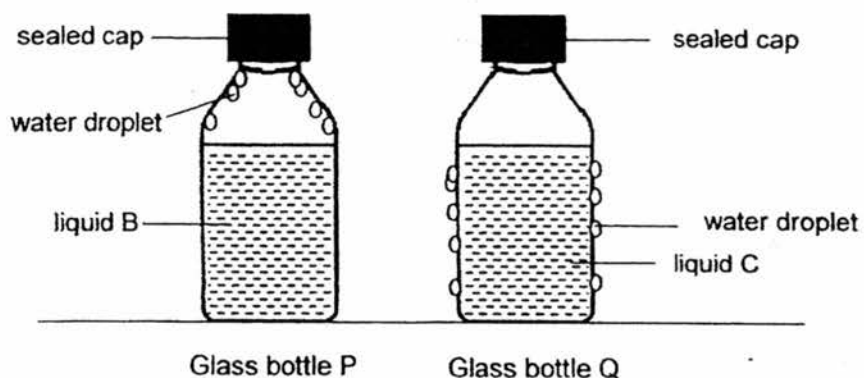

What are liquid B and C most likely to be?

	Liquid B	Liquid C
(1)	tap water	hot water
(2)	hot water	iced water
(3)	iced water	tap water
(4)	hot water	hot water

- 8 The diagram shows the water cycle.

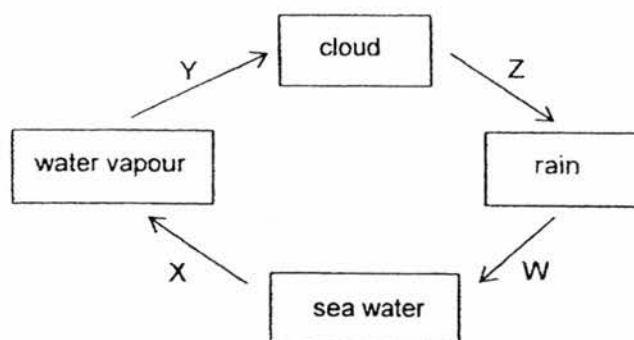

Which one of the following shows the correct changes in state?

	Liquid to gaseous	Gaseous to liquid
(1)	X	Y
(2)	Y	W
(3)	W	Z
(4)	X	Z

- 9 A group of pupils was asked to state a function of the digestive system.

Pupil	Functions of digestive system
Amy	Absorbs simple substances so that they can be used by the body.
Ben	Carries digested food to all parts of the body.
Carl	Breaks down food into simple substances.
Danny	Carries waste material away from different parts of the body.

Which of the above pupil(s) has/have stated a correct function / correct functions?

- (1) Amy only
 - (2) Amy and Carl only
 - (3) Ben and Danny only
 - (4) Ben, Carl and Danny only
- 10 The table shows a comparison between the plant and human transport system.

	Statements	Plant Transport System	Human Transport System
A	Water is transported in the system.	Yes	Yes
B	Has a centralised organ to pump materials to all parts in the system.	No	Yes
C	There are tubes to transport materials in the system.	No	Yes
D	Food produced is transported by food-carrying tubes to all parts in the system.	Yes	Yes

Which of the above comparison(s) is/are correct?

- (1) B only
- (2) A and B only
- (3) C and D only
- (4) A, C and D only

- 11 Tim wanted to find out if plants take in different amounts of water when placed at different locations in his school. He set up an experiment using the same type of plant placed in 3 identical beakers A, B and C.



He placed the beakers at different locations in the school and gave different amounts of water to each plant.

Beaker	Location	Amount of water given to each plant (ml)
A	At a classroom	100
B	At the Ecogarden	150
C	At the field	50

Tim's teacher said that his experiment was not a fair one. What change should Tim make to make it a fair experiment?

- (1) Give the same amount of water to each plant.
 - (2) Place different types of plants in each beaker.
 - (3) Place plants with different amount of roots in each beaker.
 - (4) Place plants with the same number of leaves in each beaker.
- 12 The diagrams below show the respiratory system of a fish and human.

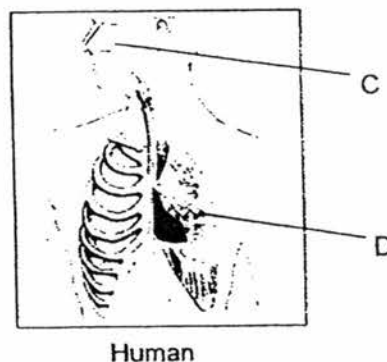
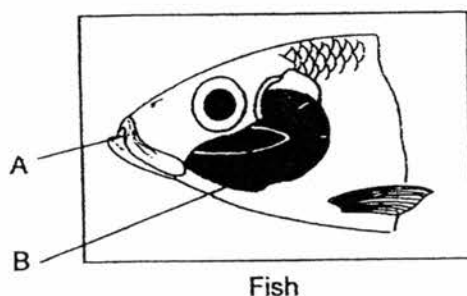

Which part of the respiratory system of the fish and human allow exchange of gases?

	Fish	Human
(1)	A	C
(2)	A	D
(3)	B	C
(4)	B	D

- 13 The diagram below shows the outer layers of a plant cell as well as the movement of substances W, X, Y and Z, in and out of the cell as represented by the arrows shown.

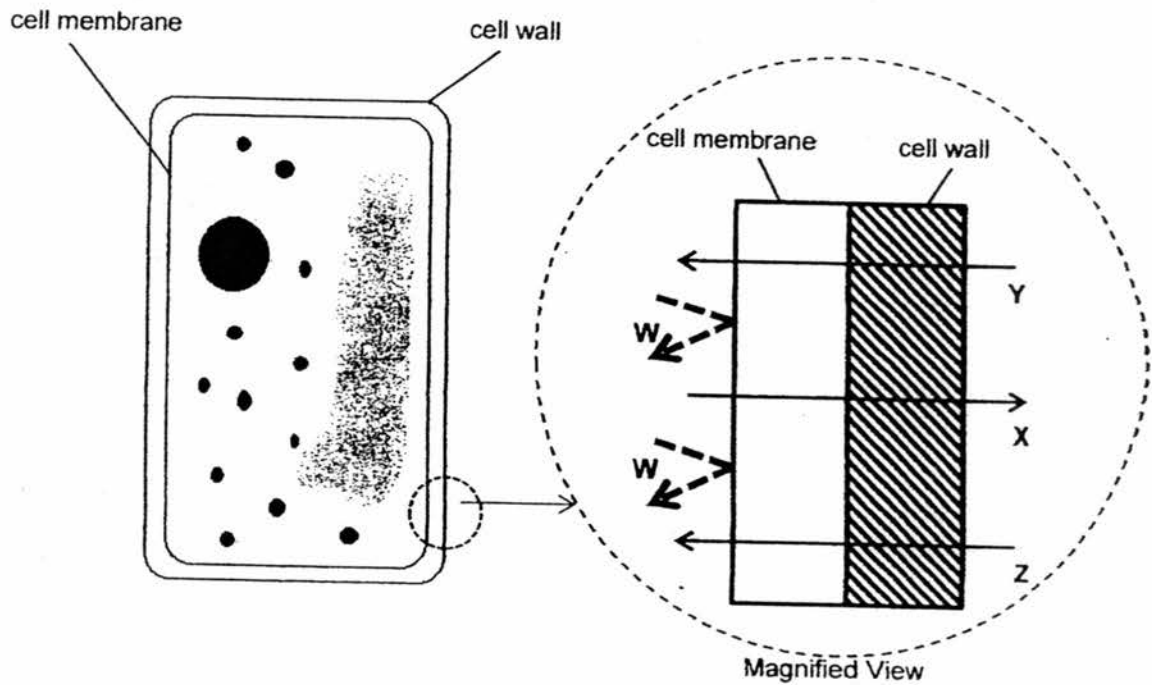

Based on the diagram, which of the following statements correctly describes the cell membrane of the plant cell?

- A It allows only substance W to pass through.
 - B It supports and gives the plant cell its shape.
 - C It controls the movement of substances in and out of the cell.
 - D It allows substances X, Y and Z to pass through but prevents substance W from passing through.
- (1) A and B only
 (2) A and C only
 (3) C and D only
 (4) B, C and D only

- 14 The diagram below shows four circuits with different arrangements of identical batteries and identical bulbs. The bulbs in all circuits light up.

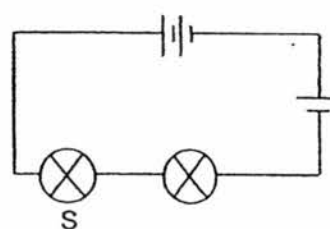
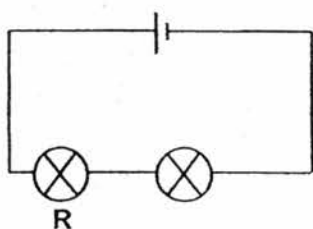
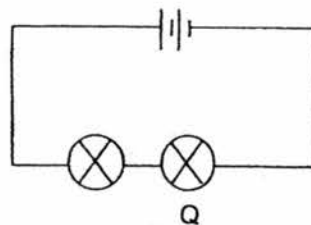
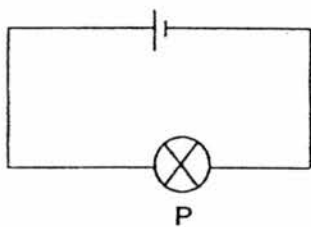

Which one of the following shows correctly the brightness of the bulbs?

Brightness of bulbs			
	Bright →	Brighter →	Brightest
(1)	R	P	S
(2)	R	P	Q
(3)	S	Q	R
(4)	Q	P	S

- 15 Michael set up an electric circuit in Set-up A as shown below. He measured the brightness of bulbs X and Y.

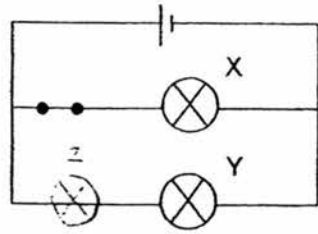

Set-up A



Set-up B

Next, he set up an identical electric circuit in set-up B and connected another identical bulb Z to the circuit in set-up B. He made the following observations:

- All three bulbs lighted up in set-up B.
- Bulbs X and Z had the same brightness in set-up B.
- Brightness of bulb X was lower in set-up B than in set-up A
- Brightness of bulb Y remained the same in set-ups A and B.

Which of the following statement(s) about the electric circuit in set-up B is/are correct?

- A When bulb X fuses, bulbs Y and Z will remain lit.
 B All the bulbs in the circuit are arranged in parallel.
 C When the switch is opened, bulb Z will not light up.

- (1) B only
 (2) C only
 (3) A and B only
 (4) A, B and C

- 16 A bar magnet was placed on a glass table as shown below. A silver block was attached to the bottom of the table. The bar magnet was then pushed along the table.

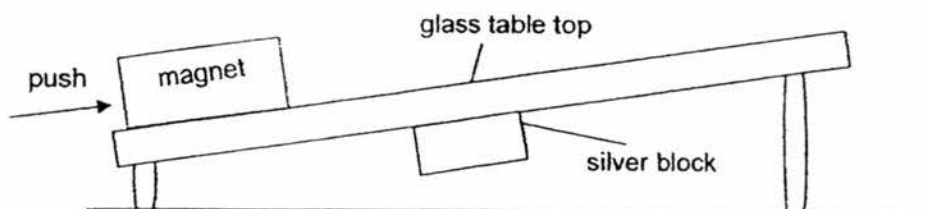

Which of the force(s) given below must the push force overcome in order for the magnet to move along the table?

- A Magnetic force
 B Frictional Force
 C Gravitational Force

- (1) C only
 (2) A and B only
 (3) B and C only
 (4) A, B and C

17 The diagram below shows a magnetic conveyor belt system in a recycling plant.

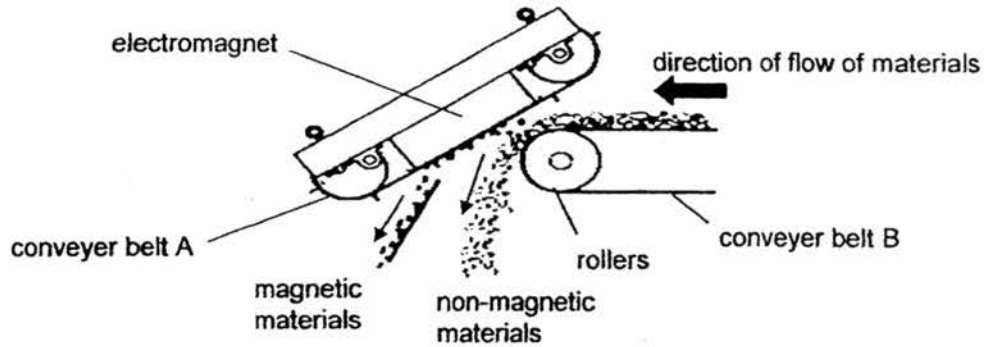

Conveyor belt A is placed to attract magnetic materials. If conveyor belt A was to be used for attracting larger magnetic materials, what should be done to the conveyor belt system if only one change was to be made?

- (1) Increase the speed of the rollers.
- (2) Increase the length of conveyor belt B.
- (3) Increase the magnetic force of the electromagnet in conveyor belt A.
- (4) Increase the height of the gap between conveyor belt A and conveyor belt B.

18 Mark set up 3 bar magnets. He brought Compass X towards side A of one of the bar magnets and Compass Y towards side B of another bar magnet. His set-up is shown in the diagram below.

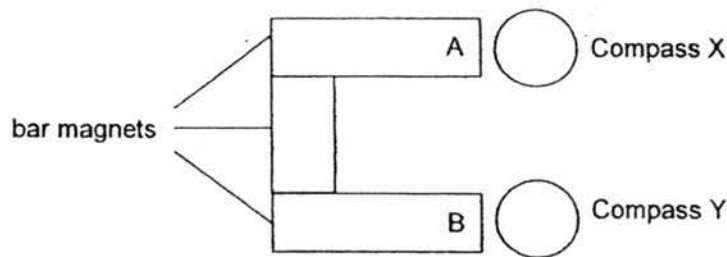

Which of the following correctly represents the directions both compasses will point to?

	Compass X	Compass Y
(1)		
(2)		
(3)		
(4)		

- 19 Gary conducted an experiment to find out which type of surface, Q, R, S and T, would be the best for making a pathway next to a swimming pool. He conducted an experiment by placing a shoe on the surface and pulling the shoe from point A to point B as shown below.

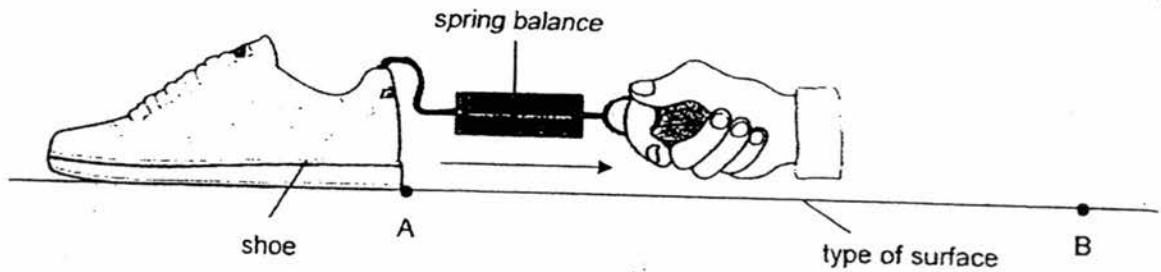

Gary repeated the experiment for each of the surfaces and recorded the amount of force needed to pull the shoe over the surfaces.

Type of surfaces	Amount of force (N)
Q	30
R	60
S	15
T	90

Based on the results, which one of the following conclusions is correct?

- (1) Surface R is the best surface for making the pathway.
- (2) Surface R creates more friction than surface Q and less friction than surface S.
- (3) There is least friction between the shoe and surface S, as compared to other surfaces.
- (4) Friction between the shoe and surface Q was greater than the friction between the shoe and surface R.

20 Jack conducted an experiment using the set-up below.

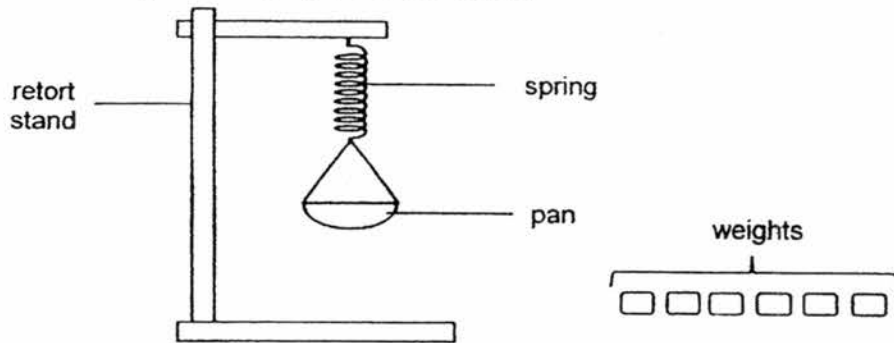

He placed identical weights in the pan, one by one, and recorded the results in the table below.

Number of weights in the pan	1	2	3	4	5	6
Length of spring (cm)	7	10	13	16	16	16

What was most likely the original length of the spring when the pan was empty?

- (1) 2 cm
- (2) 4 cm
- (3) 7 cm
- (4) 10 cm

21 The diagram below shows a scuba diver in the ocean. The swim fins labelled in the diagram enable the diver to move forward more effectively through the water.

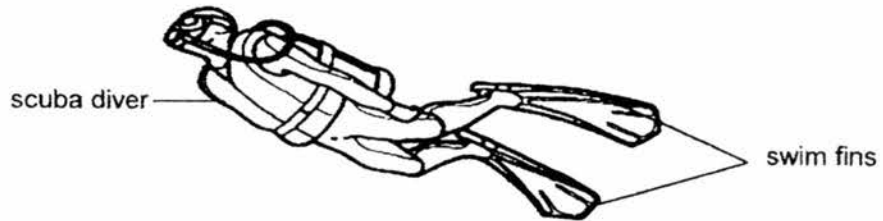

Which part of the shark, A, B, C or D, has the most similar function to the swim fins of the diver?

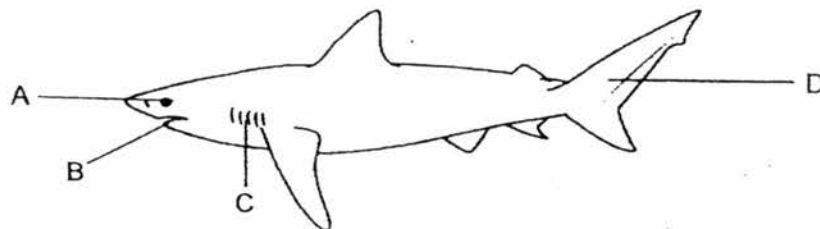

- (1) A
- (2) B
- (3) C
- (4) D

- 22 Four metal balls, A, B, C and D, are suspended on 4 identical strings of different length from the ceiling. The four strings are cut at the dotted line and the balls dropped from different heights into the sandbox as shown in the diagram below.

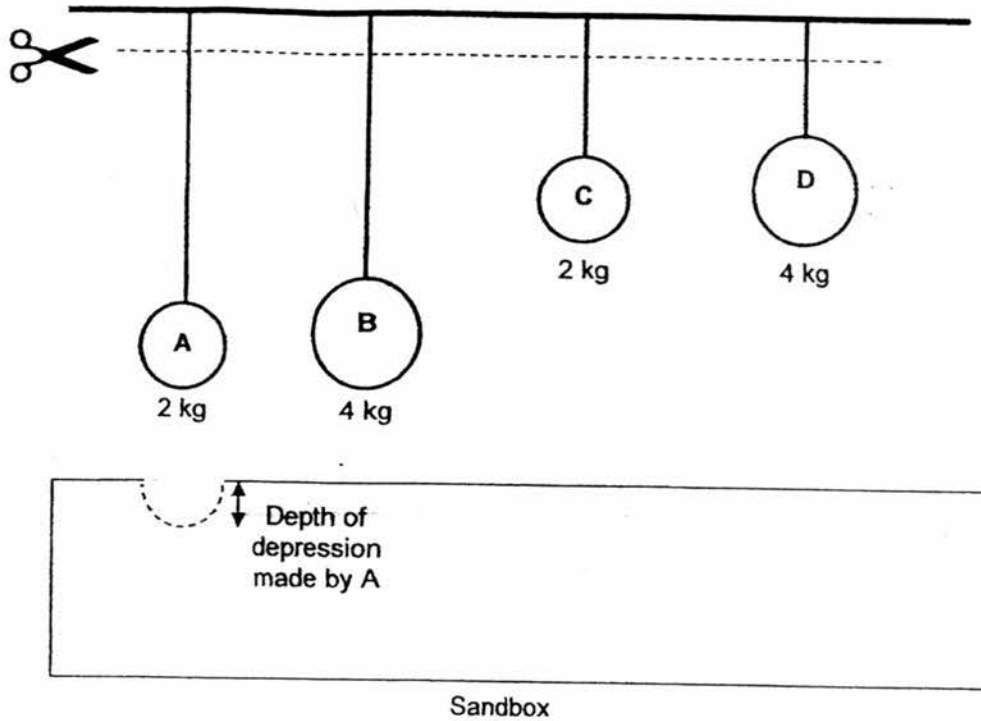

The depressions made by the balls were measured and recorded in the table below.

Ball	Depth of depression in sand (cm)
A	7
B	9
C	12
D	14

Based on the set-up above, which of the following statement(s) is/are correct?

- A More gravitational force is acting on ball D than ball B.
 - B Ball C has more gravitational potential energy than ball A.
 - C Ball D makes a deeper depression than ball C because it has more mass.
- (1) A only
 (2) A and B only
 (3) B and C only
 (4) A, B and C

- 23 The diagrams below show a cross-section of a flower and two birds, X and Y which are found in the same habitat. Both the birds feed on nectar and are attracted to brightly coloured flowers. However, only Bird Y is able to pollinate the flower.

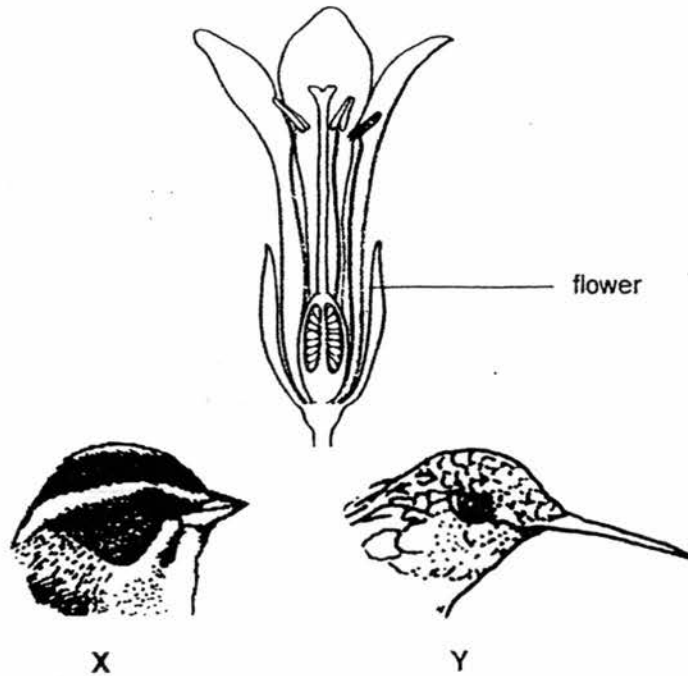

Why is the flower pollinated by bird Y and not bird X?

- (1) The petals are brightly coloured.
- (2) The flower has a strong sweet scent.
- (3) The stigma is positioned below its anthers.
- (4) The nectar is found deep within the flower.

- 24 The diagram shows a leaf bug. The leaf bug is an insect that is shaped like a leaf and has patterns on its body similar to the leaves of its surrounding.



An experiment was conducted on the leaf bugs. Four tanks W, X, Y and Z were each placed at the same location for a week with the following conditions:

- Each tank had a different type of plant
- Each tank had the same number of plants
- Each tank had the same number of leaf bugs
- Each tank had the same number of leaf bug predators
- Each tank had sufficient food for the leaf bugs to last 2 weeks

The table below shows the results of the experiment.

Tank	Number of leaf bugs before experiment	Number of leaf bugs after 1 week
W	30	13
X	30	20
Y	30	8
Z	30	30

Based on the results, which of the following statements best explain the results?

- A The leaf bugs in tank W had too much sunlight for them to survive.
 B The leaf bugs in tank Y could not camouflage themselves from predators.
 C The structure of the leaves of the plants in tank Z was similar to the leaf bug.
 D The structure and colour of the leaf in tank X was the least similar to the leaf bug.
- (1) A and B only
 (2) A and C only
 (3) B and C only
 (4) C and D only

- 25 The food web below shows the food relationships among some organisms in a pond community.

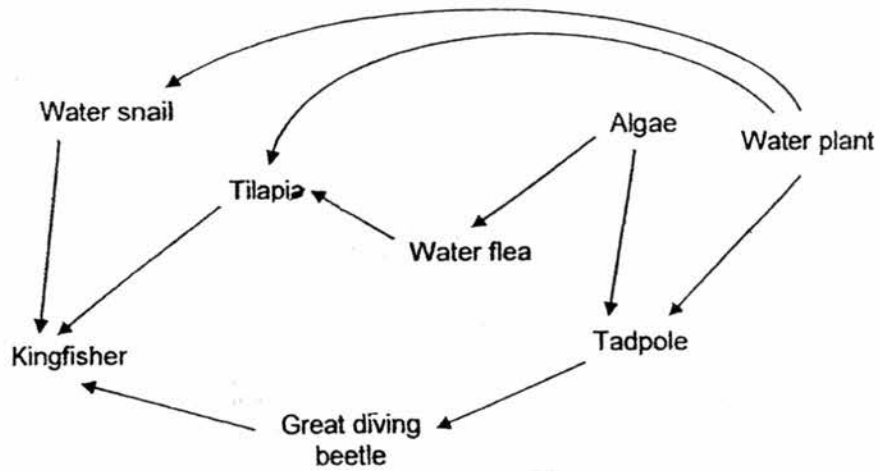

Based on the above food web, which of the following statements are true?

- A There are two omnivores.
 - B There are six food chains.
 - C There are three predators.
 - D There are three herbivores.
- (1) A and B only
 (2) C and D only
 (3) A, B and D only
 (4) B, C and D only

- 26 Decomposers enrich the soil with nutrients for the plants to grow well. The diagram below shows how decomposers act on dead matter and change them into simpler substances.

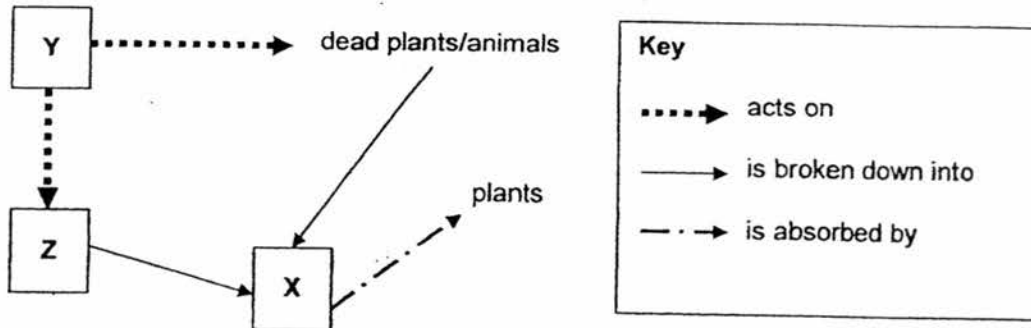

Which of the following best represent X, Y and Z respectively?

	X	Y	Z
(1)	carbon dioxide	predators	nutrients
(2)	water	fungi	carbon dioxide
(3)	mineral salts	prey	animal waste
(4)	mineral salts	bacteria	animal waste

- 27 Paul placed a pole in front of a flight of stairs as shown below.

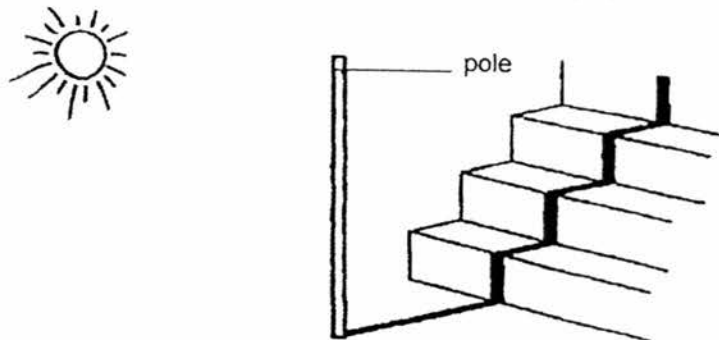

Paul made the following statements based on the diagram above.

- A Paul carried out the experiment at noon.
- B The pole is made of an opaque material.
- C The shadow is formed as light reflected off the steps.
- D The length of the pole is always the same as the length of its shadow.

Which of the above statements is/are definitely correct?

- (1) B only
- (2) A and D only
- (3) B and C only
- (4) A, C and D only

- 28 Amanda carried out an experiment using an object as shown in the diagram below. When the torchlight was switched on, a shadow formed on the screen.

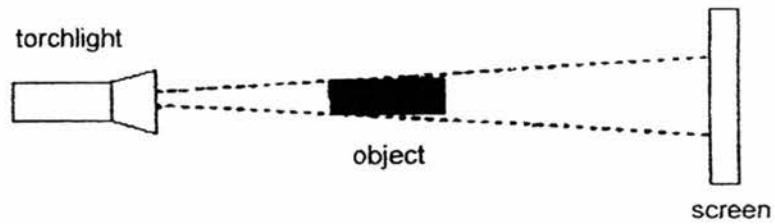

- Which of the following graphs shows the relationship between the length of the shadow cast on the screen and the distance between the torchlight and the object?

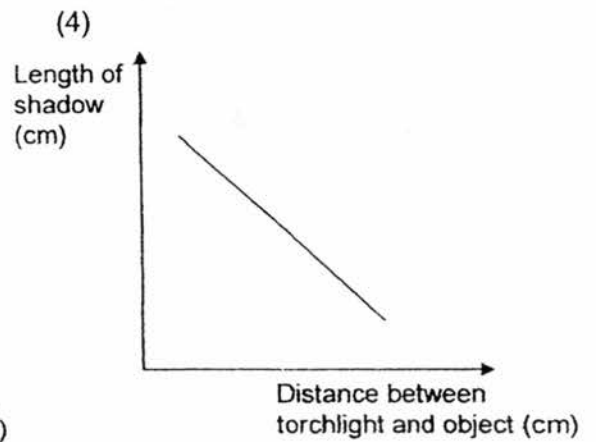
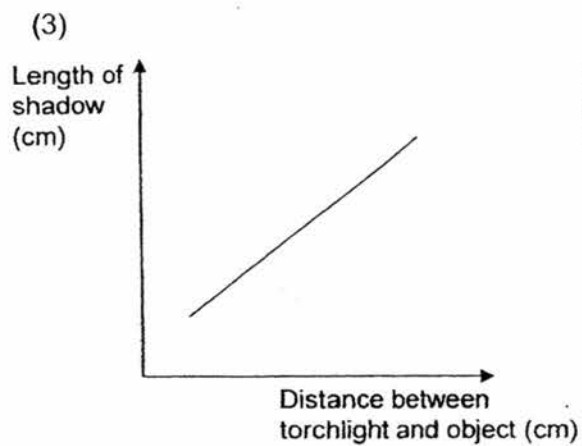
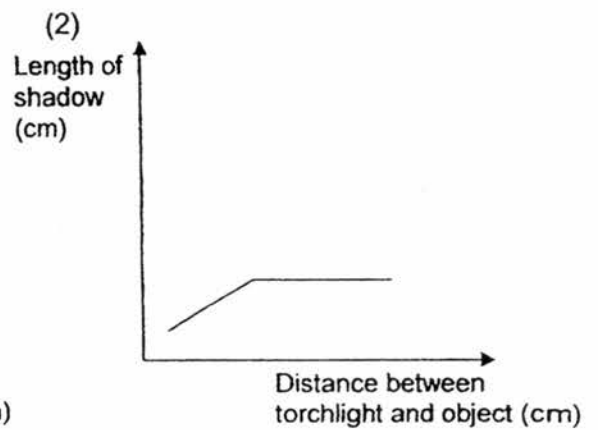
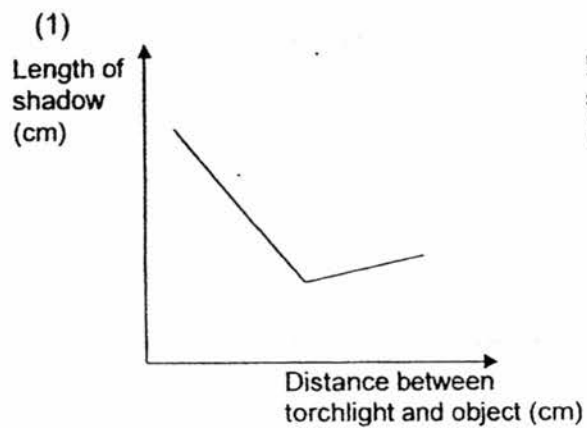

- 29 Mrs Lim made a bottle of milk for her baby. She tested the milk and realised that it was too hot. She placed the bottle of milk into a cup of cold water as shown below.

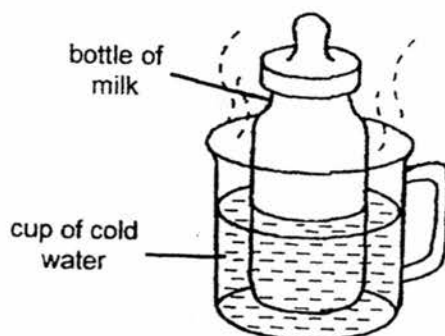

Which of the following explanations best described what happened after ten minutes?

- (1) The milk gained heat from the cup of water.
 - (2) The milk lost heat to the cold water and the surrounding air.
 - (3) There was less milk because the heat had caused it to evaporate.
 - (4) The milk gained heat from the cold water but lost heat to the surrounding air.
- 30 Tim starts to ride his bicycle from point X. He rides up the ramp, then flies through the air for a short distance before landing on the ground and stopping at Point Z as shown in the diagram below. Point Y is the highest point his bicycle was in the air.

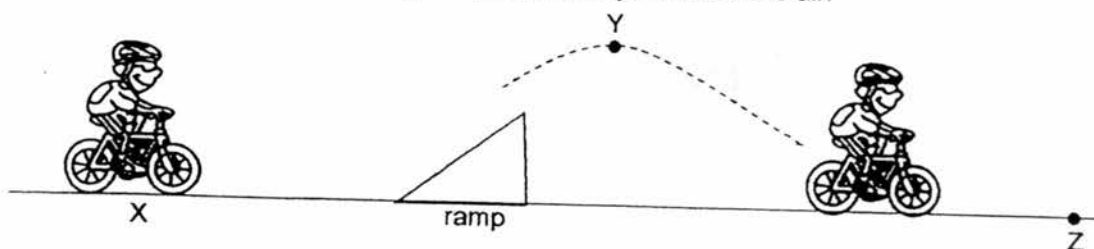

What are the main forms of energy at points X, Y and Z in the bicycle as Tim cycles it?

	X	Y	Z
(1)	chemical potential energy	kinetic energy	kinetic energy
(2)	kinetic energy	gravitational potential energy	kinetic energy
(3)	gravitational potential energy	kinetic energy	gravitational potential energy
(4)	kinetic energy	elastic potential energy	kinetic energy

Please go on to Booklet B

Anglo-Chinese School (Junior)



SEMESTRAL ASSESSMENT 1 (2016)

PRIMARY 6

SCIENCE

BOOKLET B

Tuesday

10 MAY 2016

1 hour 45 minutes

Name: _____ () Class: 6.() Parent's Signature: _____

INSTRUCTIONS TO PUPILS

- 1 Do not turn over the pages until you are told to do so.
- 2 Follow all instructions carefully.
- 3 There are 14 questions in this booklet.
- 4 Answer ALL questions.
- 5 The marks are given in the brackets [] at the end of each question or part question.

Booklet	Possible Marks	Marks Obtained
A	60	
B	40	
Total	100	

This question paper consists of 15 printed pages (inclusive of cover page).

Booklet B (40 marks)

For questions 31 to 44, write your answers in this booklet.

The number of marks available is shown in brackets [] at the end of each question or part question.

- 31 The states of 4 different substances, P, Q, R and S at different temperatures are shown in the table below.

Substance	At 28°C	At 40°C	At 78°C
P	solid	solid	liquid
Q	liquid	liquid	liquid
R	solid	solid	solid
S	liquid	liquid	gas

Based on the information given in the table, for each of the following four statements, put a tick (✓) in the correct column. [2]

Statement	True	False
i. Melting point of Substance P is at 78°C.		
ii. Substance Q has the lowest boiling point.		
iii. Substance R has the highest melting point.		
iv. Both substances Q and S have melting points below 28°C.		

(Go on to the next page)

SCORE	2
-------	---

- 32 Nathan conducted an experiment to find out which parts of a flower are required to form a fruit. He removed one different part from each of 3 identical flowers, W, X and Y, of the same plant as shown below.

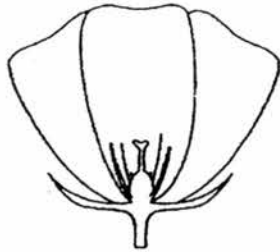

Flower W
(anther removed)

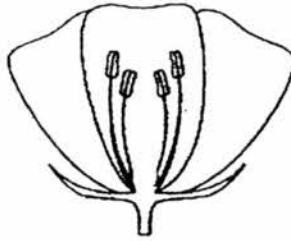

Flower X
(stigma removed)

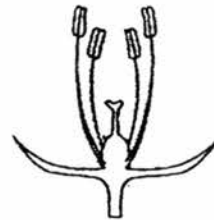

Flower Y
(petals removed)

He transferred some pollen grains from another flower of the same plant to all the remaining parts of flowers W, X and Y.

- (a) Which flower(s), W, X and/or Y, is/are able to develop into a fruit/fruits?
Explain why. [2]

- (b) Explain why plants need to disperse their seeds. [1]

(Go on to the next page)

SCORE	3
-------	---

- 33 Kamal bought two hot buns at a coffeeshop. He packed them in an enclosed metal container. When he opened the container at home half an hour later, he found that there were water droplets on the top inner surface of the container as shown in the diagram below.

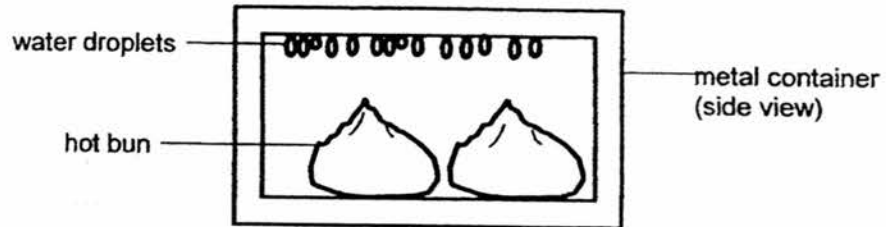

- (a) Explain clearly how these water droplets were formed. [2]

- (b) A week later, Kamal bought two identical buns from another coffeeshop. He packed them into a styrofoam container that is of the same size as the metal container. Half an hour later, he observed that less water droplets formed on the top inner surface of the container. Explain why. [1]

(Go on to the next page)

SCORE	3
-------	---

- 34 Xinrui set up an experiment with 3 containers, A, B and C, of different shapes and sizes. She poured the same amount of water into each container. She left the containers under the sun.

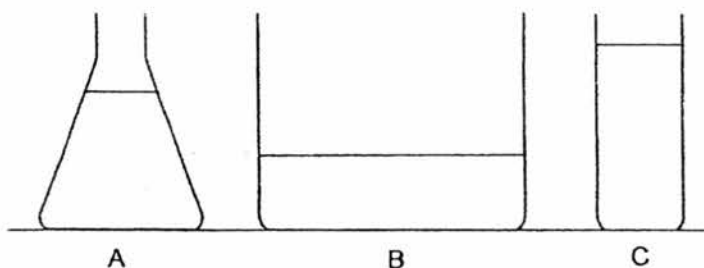

- (a) If Xinrui wanted to find out the rate of evaporation of water in each container, what should she measure at the end of the experiment? [1]

- (b) In which container will water evaporate the fastest? Explain why. [1]

- (c) Other than the factor mentioned in (b) affecting the rate of evaporation, identify two other factors that will increase the rate of evaporation in this experiment. [1]

(Go on to the next page)

SCORE	
	3

- 37 Liwen carried out an experiment to find out how the arrangement of bulbs in a circuit will affect the brightness of the bulbs. He set up two different electric circuits, J and K, in his experiment. He used all of the following apparatus for his experiment:

- 6 identical bulbs
- 4 identical batteries
- a few wires

He observed that in Circuit J, when 1 bulb fused, all the other bulbs did not light up. In Circuit K, the bulbs are brighter than those in Circuit J.

- (a) Based on the information given above, draw circuit diagrams for Circuit J and Circuit K in the space provided below. He had set up both electric circuits at the same time. [2]

Circuit J	Circuit K
-----------	-----------

- (b) What are the advantage, other than bulbs being brighter in Circuit K, and disadvantage of the arrangement of bulbs in Circuit K as compared to Circuit J? [1]

Advantage:

Disadvantage:

(Go on to the next page)

SCORE	3
-------	---

- 38 At a coffeeshop, Mr Raju pours hot tea using the pulling action from one container into another from a height as shown in the diagram below. After a while, the hot tea became cool.



- (a) What material should the containers be made of so that the hot tea can lose heat as quickly as possible? Give a reason for your answer. [1]

- (b) Explain how his pulling action allows the hot tea to lose heat much faster than leaving it in the container to cool down. [1]

- (c) When hot tea is ordered as a takeaway, it is given in a styrofoam cup instead of a plastic cup. Explain why this is so using the property of materials. [1]

(Go on to the next page)

SCORE	3
-------	---

- 39 The diagram below shows a mallet pivoted at one end. It is allowed to swing freely and hit a ball upon release.

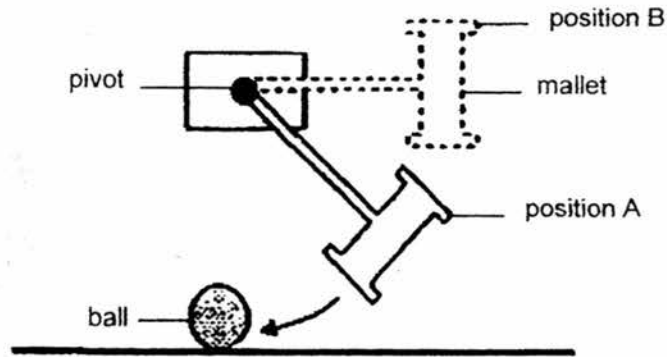

- (a) Which position, A or B, when the mallet is released from will cause the ball to travel a further distance? Explain your answer. [2]

- (b) Tom used the above set-up to carry out an experiment. He recorded the distance travelled by the ball. He then replaced the mallet with one of a smaller mass and repeated the experiment.

- (i) What was the aim of Tom's experiment?

- (ii) Predict the most likely outcome of Tom's experiment. [1]

(Go on to the next page)

SCORE	4
-------	---

- 40 Sam made a jumping toy using two pieces of strong plastic cards, some tape and a rubber band as shown in the diagram below.

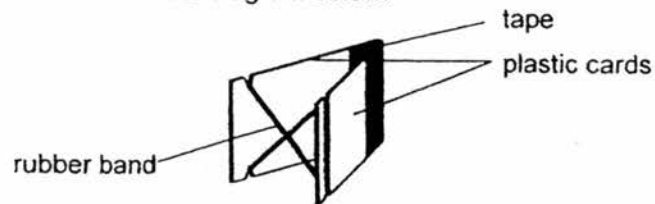

He wanted to find out how the number of rubber bands used to make the toy affects the height it jumped to. Sam stretched the rubber band and pressed it down before removing his finger from the toy.



The toy snapped and jumped to a certain height which Sam measured and recorded in the table below. He repeated the activity by increasing the number of rubber bands used at one time.

Number of rubber bands used	1	2	3	4
Maximum height reached by the toy (cm)	7	12	18	23

Based on the information above, answer the following questions:

- (a) What is the relationship between the number of rubber bands used and the height reached by the toy? [1]

- (b) Why should Sam use the same plastic cards and same type of rubber band? [1]

- (c) Other than those stated in (b), what other variable must be kept constant to ensure a fair test? [1]

(Go on to the next page)

SCORE	3
-------	---

- 41 Ben conducted an experiment to find out about the air spaces in different types of soil. He placed an equal amount of each type of soil, A, B and C, into three identical jars as shown below.

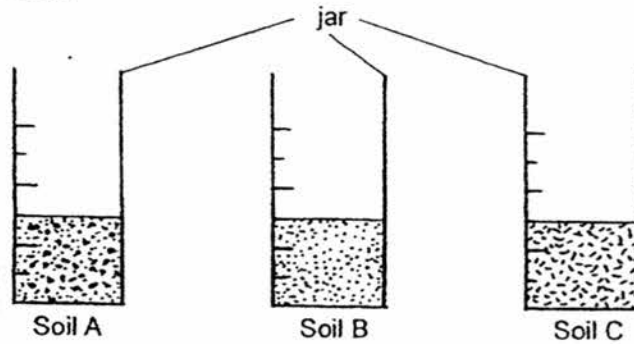

He then gently poured an equal amount of water into each jar at the same time.

- (a) What would Ben observe in the jars to show that there is air in the soil? [1]

The diagrams below show Ben's initial observations of the three set-ups after the water was poured into each jar of soil.

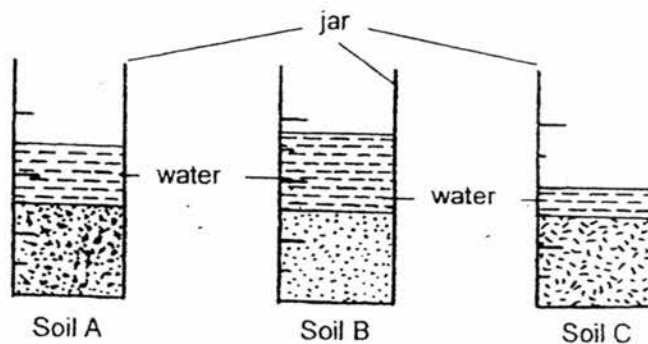

- (b) What can he conclude about the air spaces in Soils A, B and C? [1]

(Go on to the next page)

SCORE	2
-------	---

42 A, B, C, D, E and F are six organisms found in a community. The following information will help you to complete the food web below.

- E is a food producer
- B is eaten by D and F
- C eats D and F
- B and F eat E
- A eats D

(a) Complete the food web by writing the correct letters, A, B, C, D, E and F, in each circle below. [1]

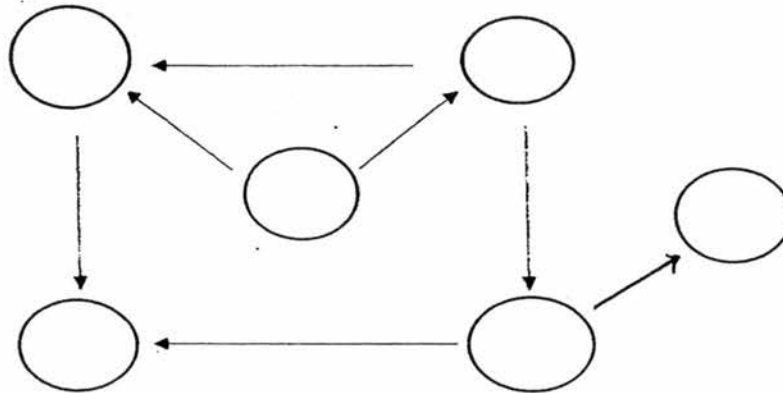

(b) Based on the food web, state which organism(s) is/are: [1]

(i) Both prey and predator: _____

(ii) Herbivore: _____

(c) If the population of A becomes extinct, how would organism D be affected? Explain why. [1]

(Go on to the next page)

SCORE	3
-------	---

- 36 The diagram below shows the flow of blood in a human circulatory system. A, B, C and D represent blood vessels. The arrows represent the movement of blood in the body.

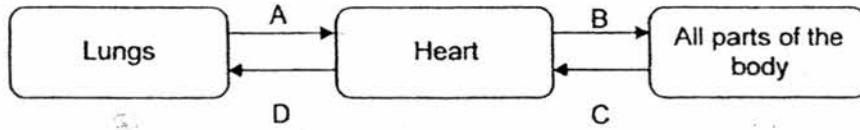

- (a) Explain why blood must flow from the heart to the lungs, and back to the heart again before it is sent to all parts of the body. [2]

The diagram below shows the transport of substances, represented by the arrows, in a plant transport system.

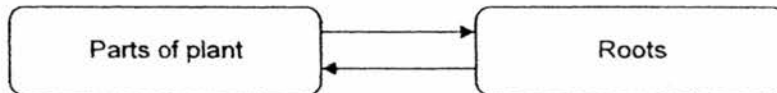

In the human circulatory system, when blood vessel A is entirely blocked, the movement of substances in blood vessels B, C and D are also affected.

- (b) Explain why, in a plant transport system, when the path of substance(s) from parts of plant to the roots is entirely blocked, the movement of substance(s) from the roots to parts of plant will not be affected. [1]

(Go on to the next page)

SCORE	3
-------	---

- 35 The diagram below shows the amount of undigested food as it enters parts of the digestive system.

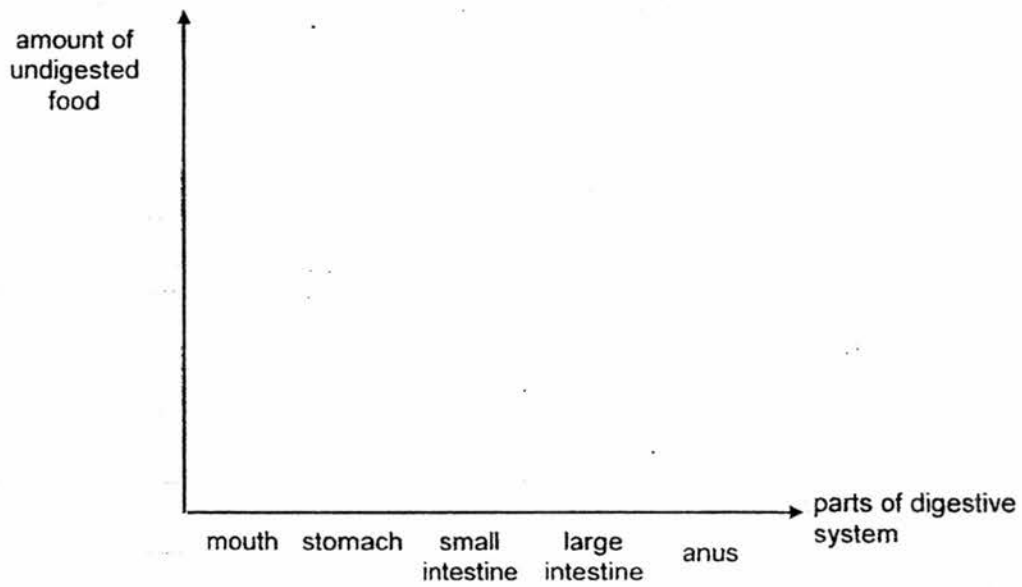

- (a) Complete the bar graph to show the amount of undigested food at the stomach. [1]
- (b) Based on the graph, what can you conclude about digestion of food in the large intestine? [1]
- _____
- _____
- (c) Explain clearly the path of digested food from the small intestine to the body cells. [1]
- _____
- _____

(Go on to the next page)

SCORE	3
-------	---

43 The diagram below shows Animal S and Animal T. They are both slow-moving animals.

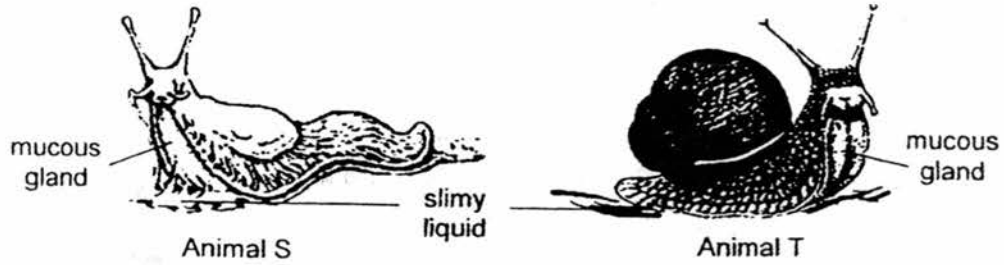

(a) Both Animal S and Animal T produce a slimy liquid substance from their mucous gland, which is found on the underside of their bodies, when they move. How does this help the animal in its movement? [1]

(b) How does Animal T protect itself when threatened by a predator?

(c) Animal S is unable to protect itself like Animal T. However, when it is threatened by a predator, it produces a lot of the slimy liquid which covers its whole body. How do you think this would protect it from its predator? [1]

(Go on to the next page)

SCORE	3
-------	---

- 44 The bird-dropping spider has adapted itself to live in the rainforest. It looks like bird droppings when it stays motionless on a leaf during the day as shown below. It usually hunts at night. Its main predators are birds.

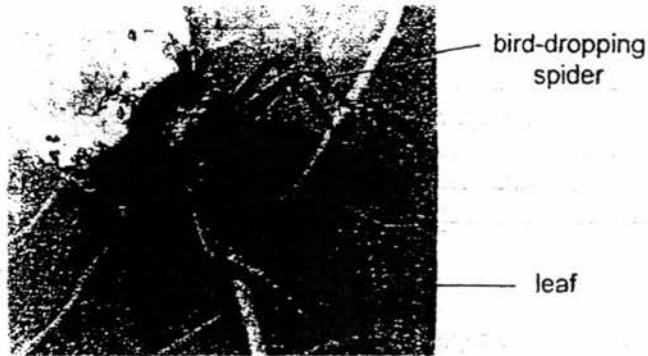

- (a) Based on the description above, how does the structural adaptation of the bird-dropping spider decrease its chances of being spotted by birds? [1]

The food web below shows the food relationship of the bird-dropping spider with other organisms in its habitat.

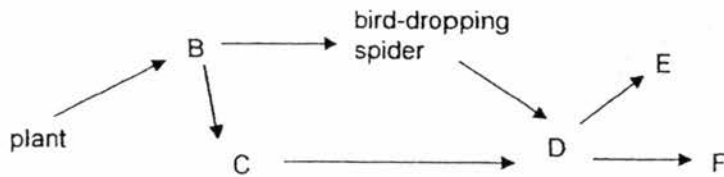

- (b) The period of daylight is shorter in certain months in the habitat where the bird-dropping spiders can be found. What would happen to the population of Organism B in those months? Explain your answer. [1]

End of Paper

SCORE	2
-------	---

EXAM PAPER 2016
LEVEL : PRIMARY 6
SCHOOL : ANGLO-CHINESE SCHOOL (JUNIOR)
SUBJECT : SCIENCE
TERM : SA1

Q1	Q2	Q3	Q4	Q5	Q6	Q7	Q8	Q9	Q10
2	1	1	4	3	3	2	1	2	2
Q11	Q12	Q13	Q14	Q15	Q16	Q17	Q18	Q19	Q20
1	4	3	1	2	3	3	1	3	2
Q21	Q22	Q23	Q24	Q25	Q26	Q27	Q28	Q29	Q30
4	3	4	3	2	4	1	4	2	2

Q31. Melting point of substance P is 78 Degrees Celsius - False
 Substance Q has the lowest boiling point - False
 Substance R has the highest melting point - True
 Both substances Q and S have melting points below 28 Degrees Celsius - True

Q32a) W and Y. The stigmas were still there for pollination and fertilization to take place.

b) To prevent overcrowding so that there is no competition with other plants for light, space, water and nutrients.

Q33a) The water vapour from the hot bun made contact with the cooler inner surface of the metal container. Therefore, the water vapour condensed into water droplets.

b) Styrofoam is a poor conductor of heat therefore less water vapour condenses to form water droplets.

Q34a) The amount of water left in each container.

b) B. It had the largest exposed surface area, hence the water gains the most heat.

c) Wind and temperature.

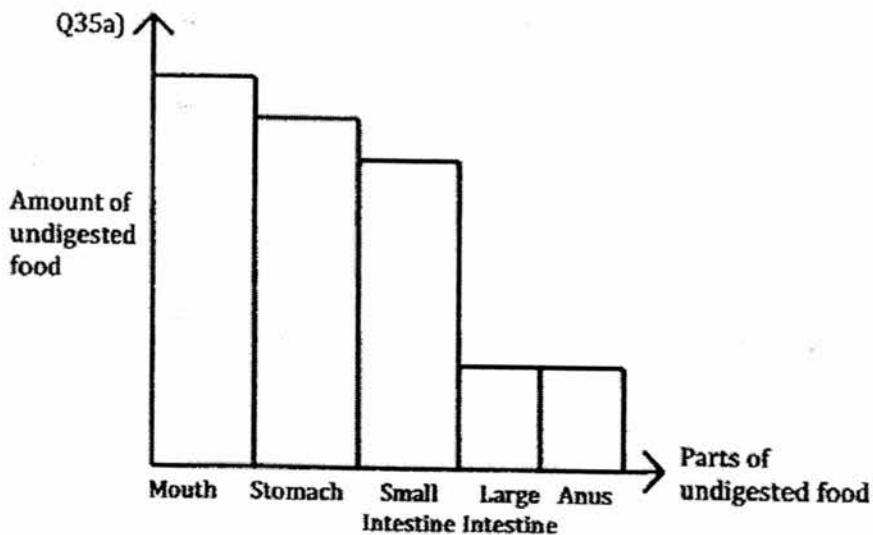

b) The large intestine does not digest any food.

c) Digested food is absorbed through the walls of the small intestine and into the bloodstream.

Q36a) The blood from the heart flows to the lungs to exchange carbon dioxide for oxygen and back to the heart to send blood rich in oxygen to all parts of the body.

b) The substances move through different tubes.

Q37a)

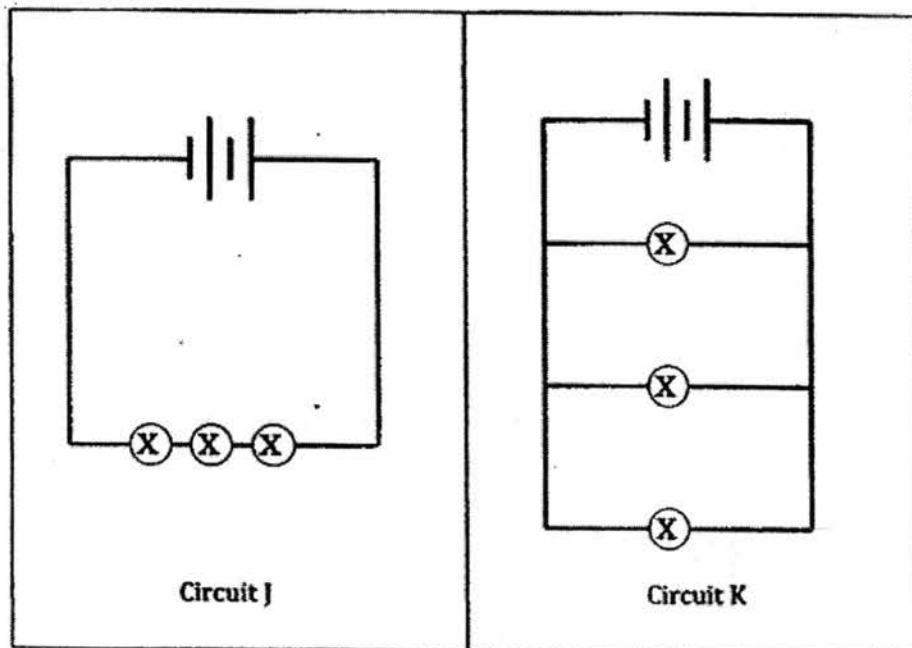

b) Advantage: When one bulb fuses, the others will still light up.
Disadvantage: Use up more electricity.

Q38a) Iron. It is a good conductor of heat.

b) This increases the exposed surface area of the hot tea.

c) Styrofoam is a poorer conductor of heat than plastic. Therefore, styrofoam is able to keep the drink hot for a longer period of time.

Q39a) Position B because it is higher than position A so the mallet has more gravitational potential energy which will be converted to more kinetic energy of the mallet to more kinetic energy in the ball.

b)(i) To find out if the mass of the mallet would affect the distance travelled by the ball.

(ii) The ball will travel a shorter distance.

Q40a) The more the number of rubber bands, the higher the toy jumped.

b) To ensure that the height that the toy jumped to is only affected by the number of rubber bands.

c) The thickness of the tape.

Q41a) Bubbles will be observed.

b) Soil C has the most amount of air spaces followed by Soil A and B.

Q42a)

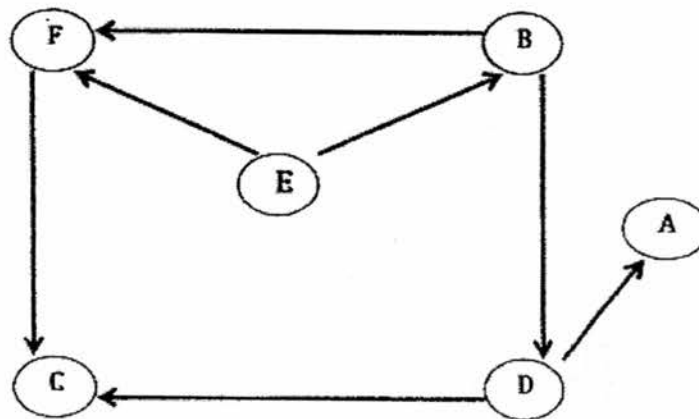

b)(i) D and F

(ii) B

c) The population of organism D would increase. It would have one less predator which is only C.

Q43a) It reduces friction between the ground and their body and allowing them to move more easily.

b) It would hide in its shell and use the shell as a protective layer.

c) It would not be easy for the predator to grip onto S as there would be less friction between the predator's claws and animal S's body.

Q44a) Birds would think that it is a bird dropping and ignore it.

b) More time for the bird-dropping spiders to hunt for organism B, thus the population of B will decrease. The population of plants will decrease because there is less light for them to photosynthesize, hence less food for organism B.

www.testpaper.biz