



RAFFLES GIRLS' PRIMARY SCHOOL

SEMESTRAL ASSESSMENT (1)

2006

Name : _____ Class: P6 _____ Index No: _____

10 May 2006

SCIENCE

Att: 1 h 45 min

Out of 100 marks	<u>Class</u>	<u>Level</u>
Highest score		
Average score		
Parent's Signature		

SECTION A (30 X 2 marks)

For each question from 1 to 30, four options are given. One of them is the correct answer. Make your choice (1, 2, 3 or 4). Shade the correct oval on the Optical Answer Sheet (OAS).

1. Study the classification table on animals below.

Animals		
X	Y	Z
bee	seal	eel
beetle	whale	stingray
grasshopper	walrus	seahorse

Which one of the following shows correctly what X, Y and Z represent?

	X	Y	Z
(1)	insect	mammal	reptile
(2)	reptile	insect	mammal
(3)	mammal	fish	reptile
(4)	insect	mammal	fish

2. The organisms shown below share certain similar characteristics that are **NOT** observable through the pictures.

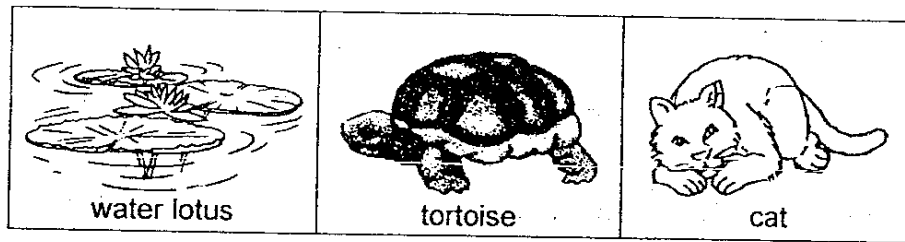

These organisms are living things because _____.

- A. they can die
- B. they respond to stimuli
- C. they can make their own food
- D. they can move from place to place by themselves

- (1) A only
- (2) A and B only
- (3) A, B and D only
- (4) A, B, C and D

3. Study the classification chart below.

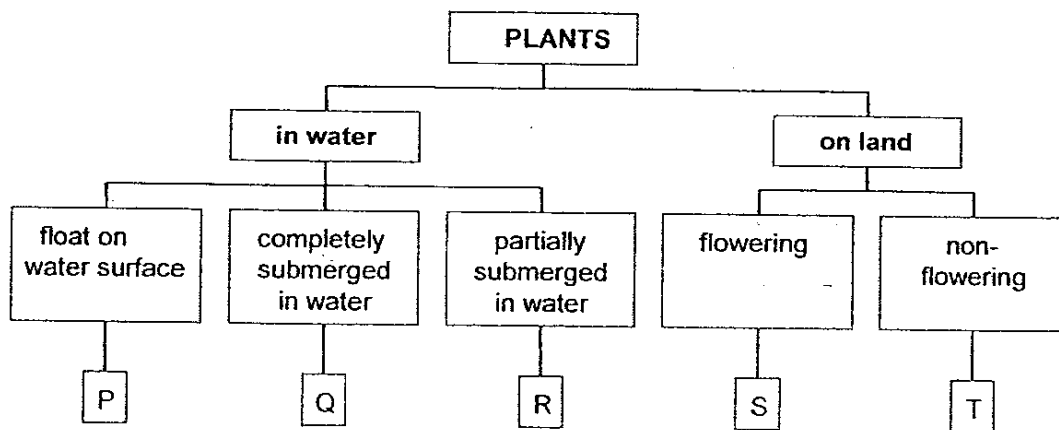

Which one of the following plants can be represented by P?

- (1) hydrilla
- (2) mimosa
- (3) duckweed
- (4) frangipani

4. Which one of the following statements is **FALSE**?

- (1) Jew's ears and mushrooms are fungi.
- (2) Fungi can grow on living plants and animals.
- (3) Mushrooms are classified as plants because they can grow in the soil.
- (4) Fungi break down their food into simple substances and cause food to decay.

5. The shapes of the Moon on 7th March and 14th March are shown below.



7th March

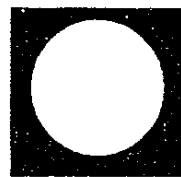

14th March

What would the shape of the Moon on 24th March be?

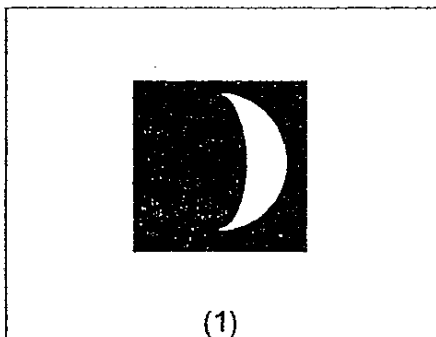

(1)

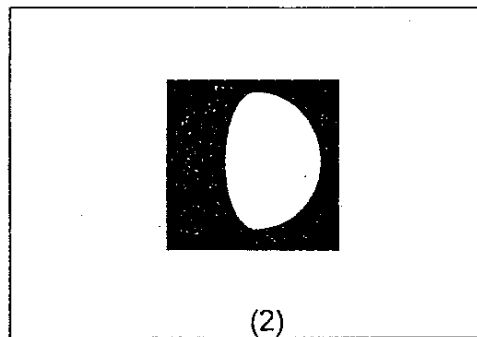

(2)

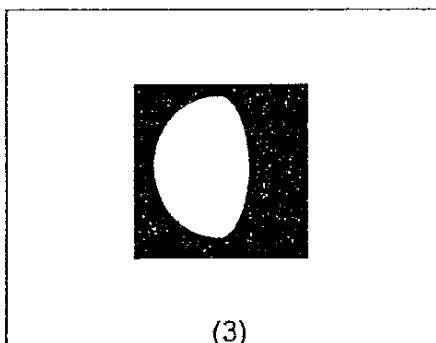

(3)

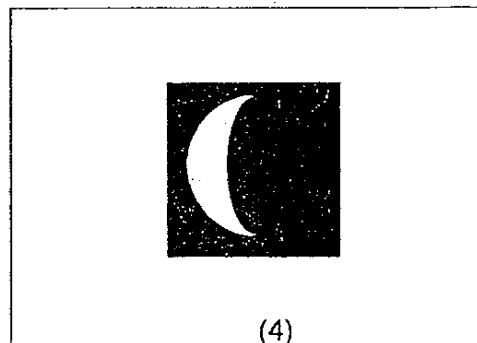

(4)

6. Anna saw the cell below under a microscope and concluded that it was an animal cell.

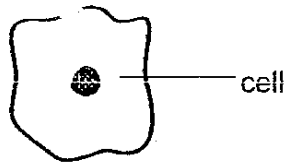

Which characteristics of the cell helped Anna to conclude that it was an animal cell?

- A. It has a nucleus.
- B. It has no cell wall.
- C. It has no chloroplasts.
- D. It has a cell membrane.

- (1) A and B only
- (2) B and C only
- (3) A and C only
- (4) C and D only

7. The following plants are classified according to how their seeds are dispersed.

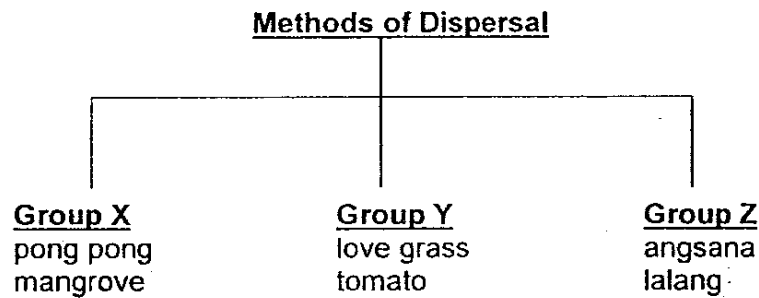

Which one of the following shows the plants placed in the correct groups?

	Group X	Group Y	Group Z
(1)	coconut	mimosa	shorea
(2)	nipah	guava	mimosa
(3)	water lily	strawberry	balsam
(4)	coconut	balsam	nipah

8. During a process known as external fertilisation, a male adult salmon squirted a substance to fertilise the eggs which a female adult salmon laid.

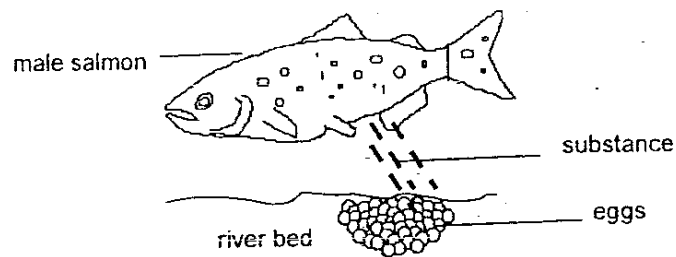

Which of the following is/ are correct about external fertilisation in the above situation?

- A. Cell division takes place in the fertilised eggs.
- B. The young salmon only inherits genes from the male adult.
- C. The young salmon only inherits genes from the female adult.
- D. The young salmon inherits genes from both the male adult and the female adult.

- (1) B only
- (2) C only
- (3) A and B only
- (4) A and D only

9. In the experiment shown below, Ali pushed the upright bottle vertically downwards into the water until the bottom of the bottle touched the bottom of the pail.

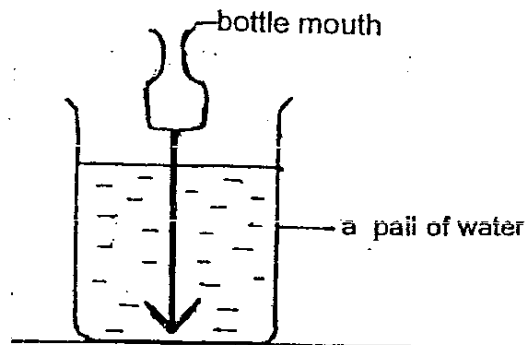

Which of the following took place?

- A. Very little water entered the bottle.
- B. Water did not enter the bottle at all.
- C. Water entered the bottle and filled up the bottle.
- D. Bubbles escaped from the mouth of the bottle to the water surface.

- (1) A only
- (2) B only
- (3) A and D only
- (4) C and D only

10. A pot full of water at 30°C was heated. When the water boiled 15 minutes later, it was further heated for another 45 minutes.

Which one of the following shows the changes in the temperature of the water in the pot when it was heated continuously for a total of 1 hour?

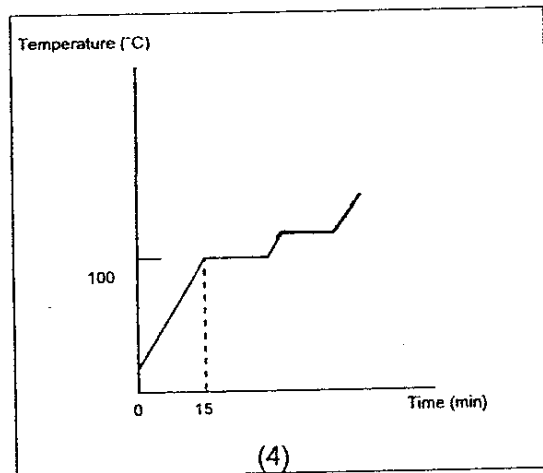
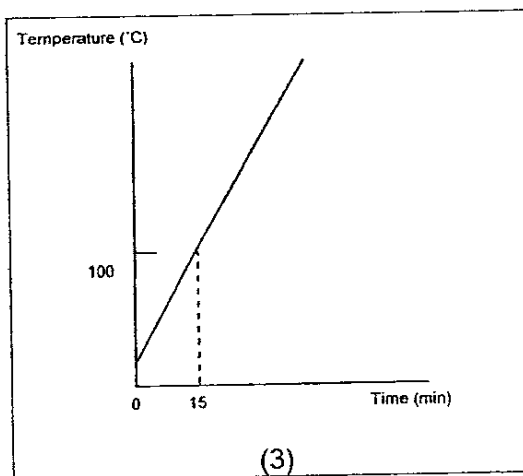
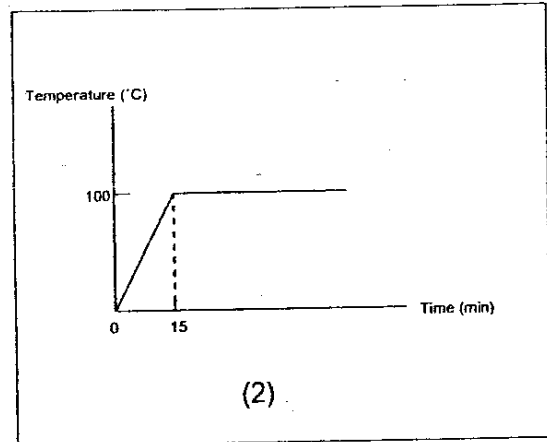
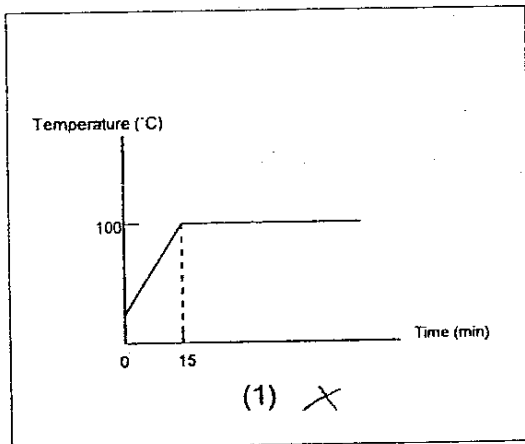

11. Water that contains a high concentration of fertilisers leads to the growth of algae. Algae are found to grow rapidly in certain parts of the river shown below.

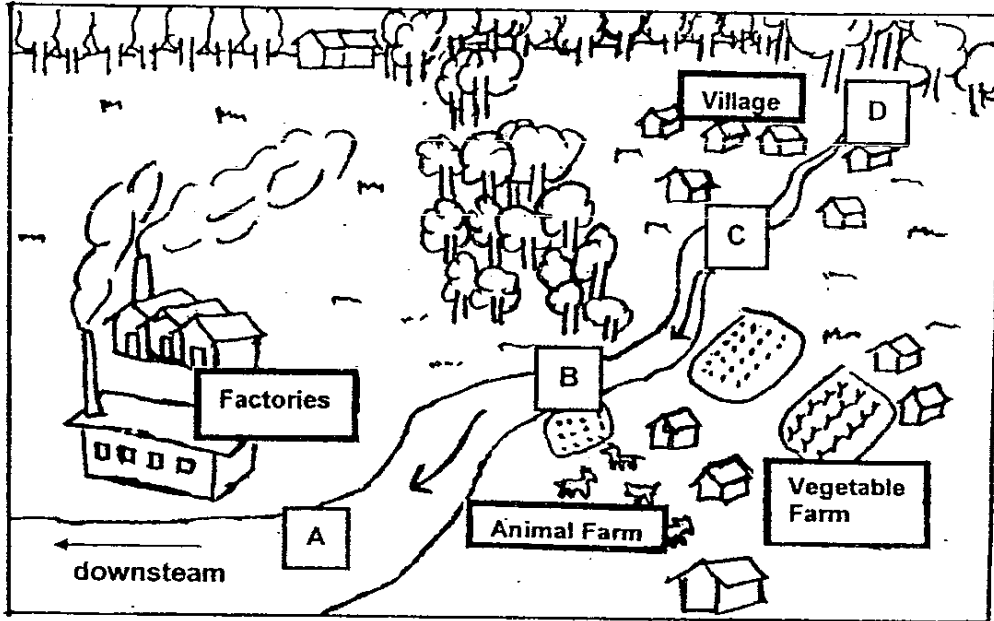

In which part(s) of the river are algae found to be growing rapidly due to human activities?

- (1) C only
(2) A and B only
(3) A, B and D only
(4) B, C and D only

12. Study the circuit below.

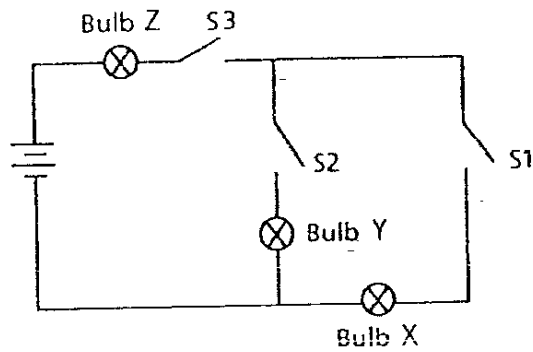

Which switches must be closed in order for only Bulbs Y and Z to light up?

- | | |
|--------------------|--------------------|
| (1) S1 and S2 only | (2) S1 and S3 only |
| (3) S2 and S3 only | (4) S1, S2 and S3 |

13. The following picture is a magnified view of the underside of a leaf as observed under a microscope.

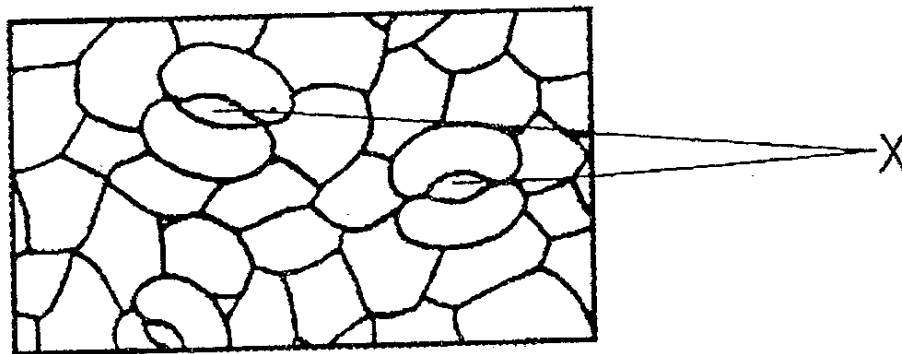

Which one of the following is true about the parts labelled X in the picture?

- A. X absorb sunlight for the leaf to make food.
- B. X allow excess water vapour to escape through them.
- C. X enable the leaf to exchange gases with its surroundings.
- D. X are cells with special functions found on the entire leaf surface.

- | | |
|---------------------|---------------------|
| (1) B and C only | (2) A, B and D only |
| (3) B, C and D only | (4) A, B, C and D |

Name: _____ Index no.: () Primary 6 ()

16. Look at the picture below.

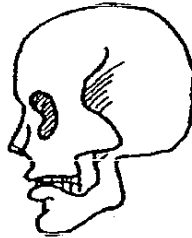

Which of the following bones have the same protective function as the part of the skeleton shown in the picture above?

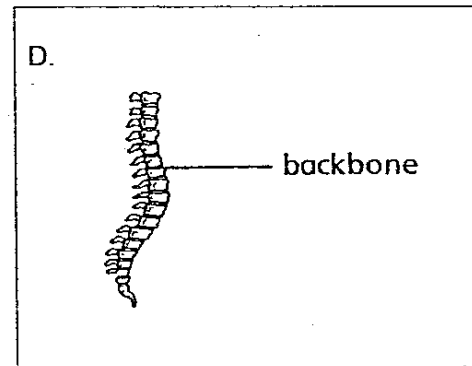
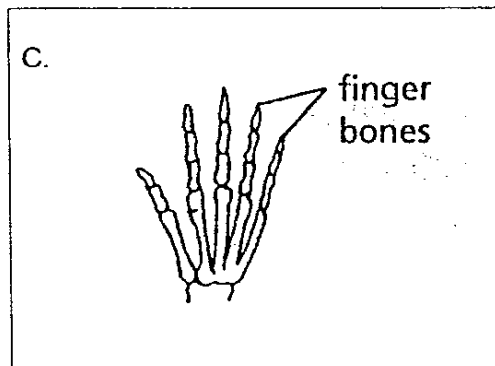
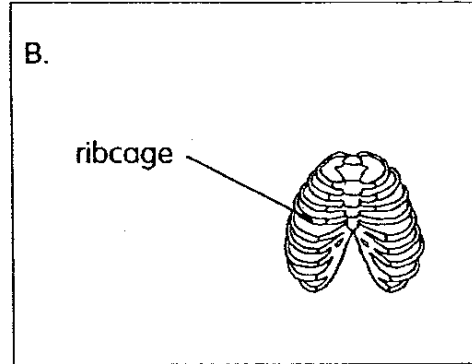
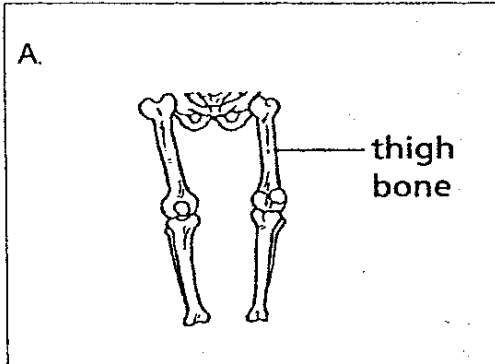

(1) B only

(2) A and C only

(3) B and D only

(4) A, C and D only

17. The picture below shows the gases needed by and produced by plant S.

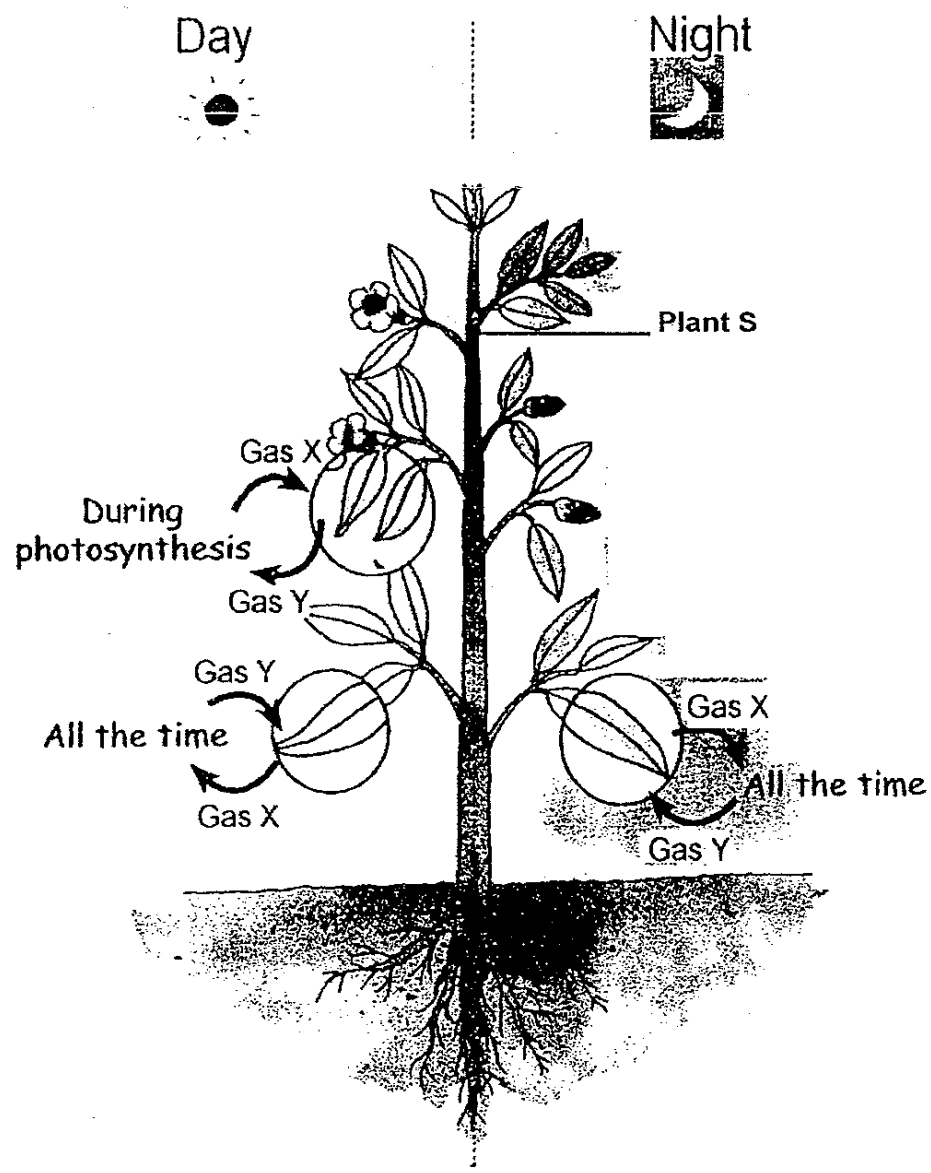

Which one of the following graphs shows the amount of Gas Y released by Plant S throughout the day?

(1)

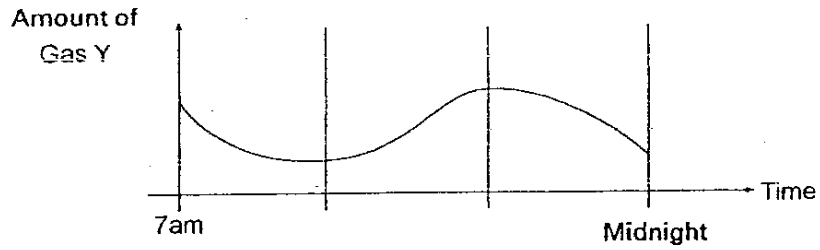

(2)

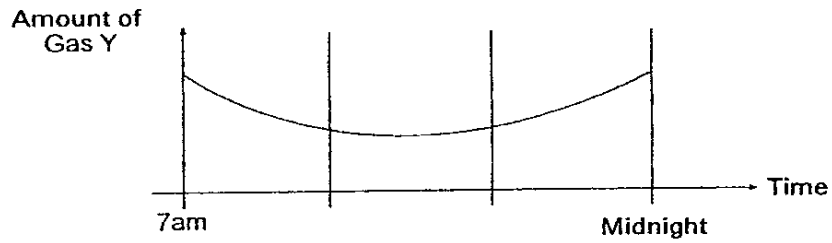

(3)

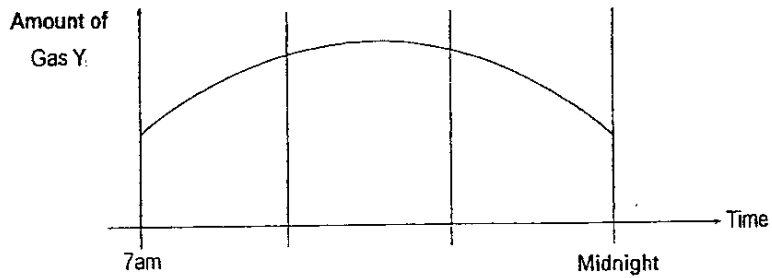

(4)

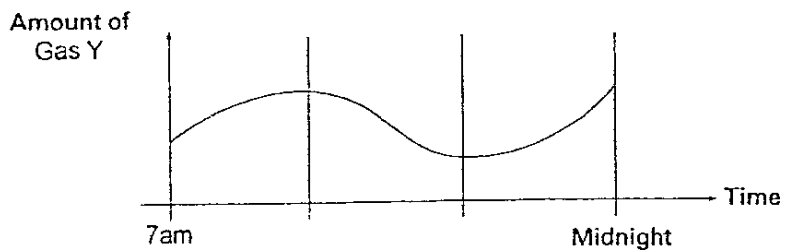

18. Ethel hung various loads on 2 springs, Spring A and Spring B. She recorded her results and plotted the graph below.

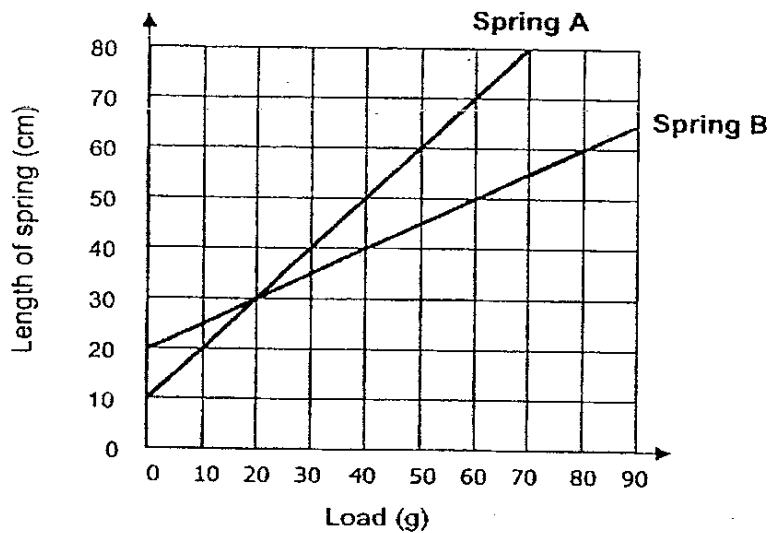

Based on the graph, which one of the following shows the correct information about Spring A and Spring B?

	The spring with a longer original length is	The spring that stretched more is
(1)	Spring A	Spring B
(2)	Spring B	Spring B
(3)	Spring A	Spring A
(4)	Spring B	Spring A

19. Elliot hung 4 metal bars, A, B, C and D, from horizontal rods as shown below. He brought the north pole of a bar magnet near end X and then end Y of each metal bar.

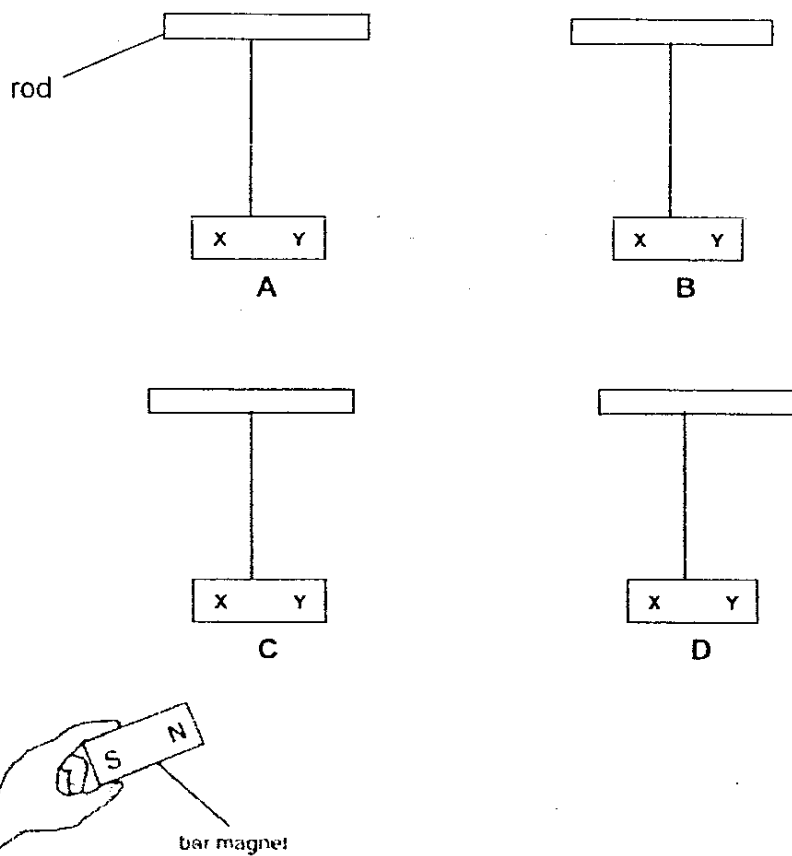

Elliot recorded the observations made during the experiment in the following table.

Metal bar	Observations	
	North pole and end X	North pole and end Y
A	attracted	repelled
B	attracted	attracted
C	no reaction between North pole and end X	no reaction between North pole and end Y
D	repelled	attracted

Which of the metal bars are magnets?

- (1) A and D only (2) B and D only
 (3) A, B and C only (4) A, B and D only

20. The diagram below shows some pond organisms classified in a chart .

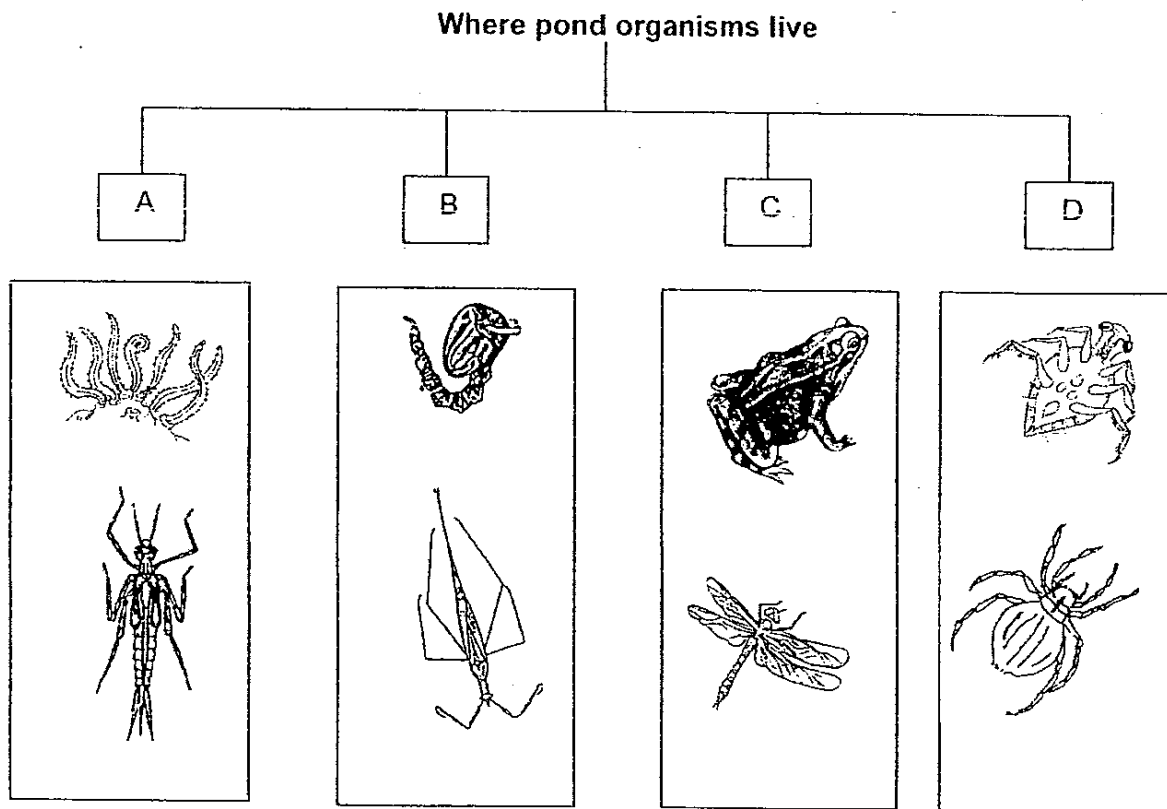

Which group, A, B, C or D, does the animal below belong to?



- (1) A
- (3) C

- (2) B
- (4) D

22. Sarah collected some organisms from two leaf litter communities, X and Y, in a forest. The type and number of organisms collected are shown in the graph below.

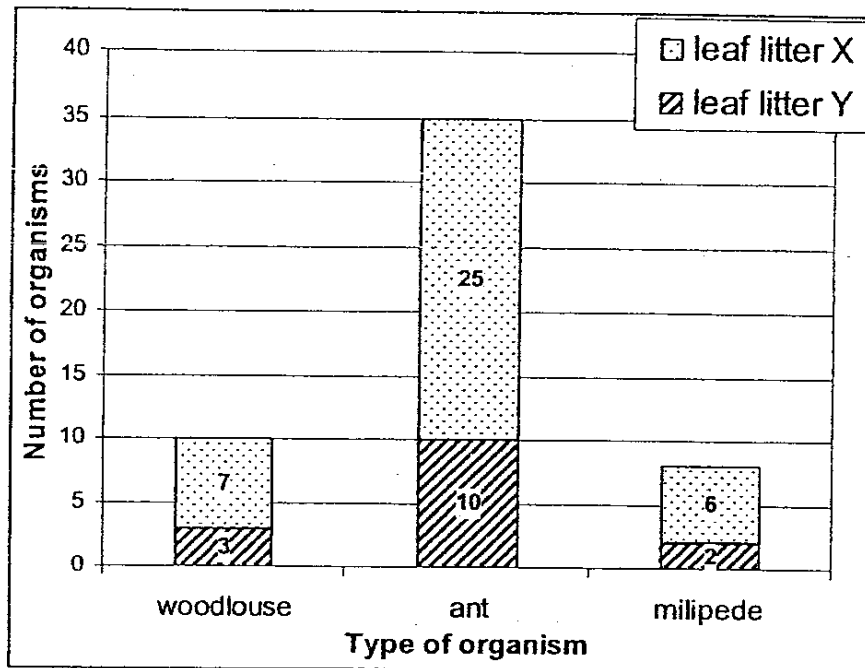

Sarah observed that the conditions in both leaf litters X and Y were similar and favourable for the survival of the organisms. What is the most likely reason for the difference in the number of organisms in these two leaf litters?

- (1) Leaf litter X was formed earlier than Leaf litter Y.
- (2) Leaf litter X has more moisture than Leaf litter Y.
- (3) There are disease-causing organisms in Leaf litter X.
- (4) Leaf litter Y is exposed to sunlight for a longer period of time than Leaf litter X.

23. The diagram shows four gears, A, B, C and D. The direction of rotation of Gear A is as shown.

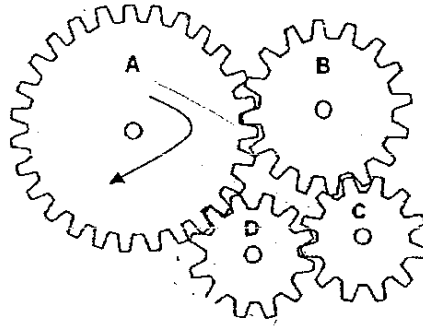

Which one of the following correctly describes the direction of rotation of Gears B, C and D?

	Gear B	Gear C	Gear D
(1)	anti-clockwise	anti-clockwise	clockwise
(2)	clockwise	anti-clockwise	clockwise
(3)	anti-clockwise	clockwise	anti-clockwise
(4)	clockwise	clockwise	anti-clockwise

24. Emma broke a bar magnet into 3 pieces, A, B and C, as shown below.

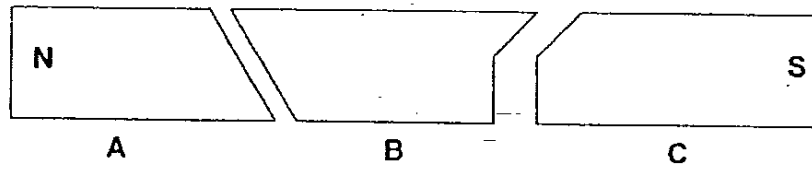

Which one of the following is **NOT** possible when 2 broken pieces of the magnet are brought together?

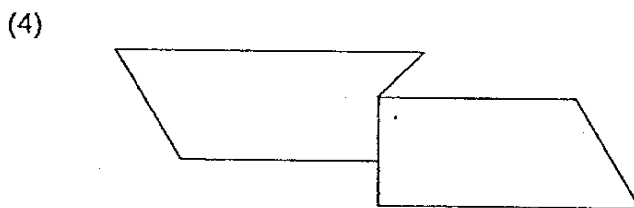
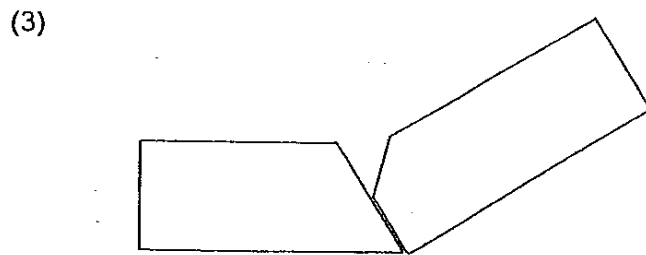
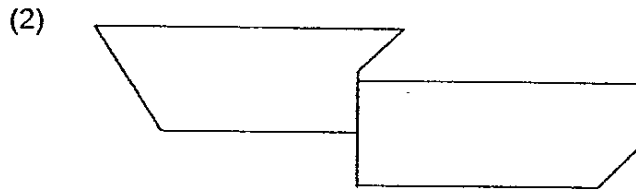
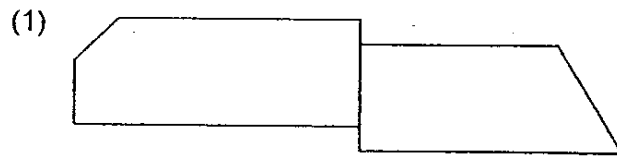

25. Amina wanted to find out how the amount of energy used was affected by the activities of her friend, Tom. She set up her investigation as shown in the pictures below.

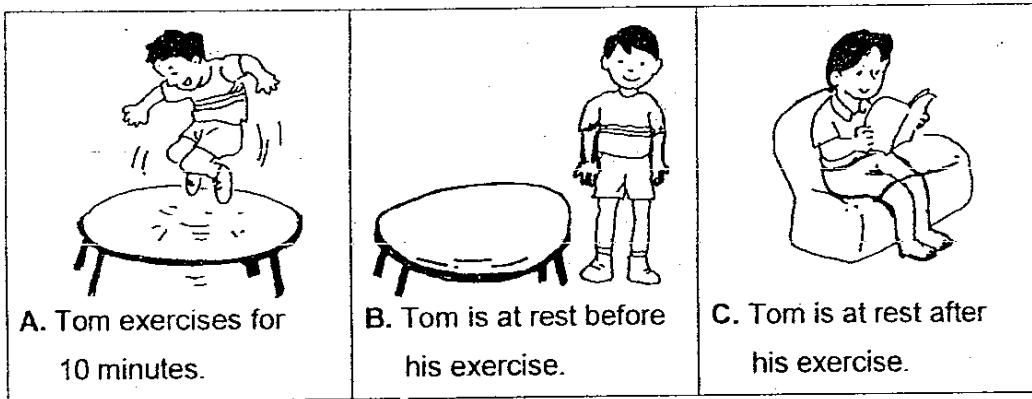

Which one of the following graphs correctly shows how much energy is used for each activity?

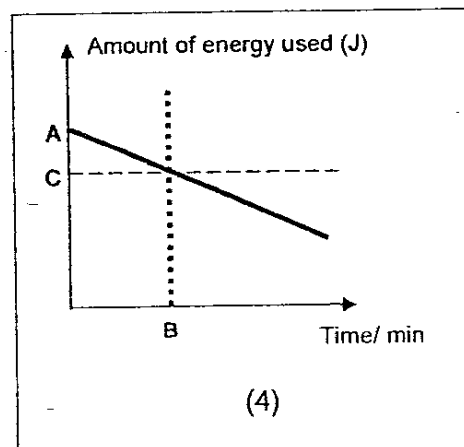
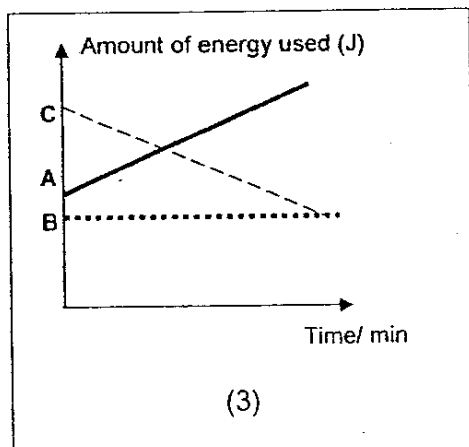
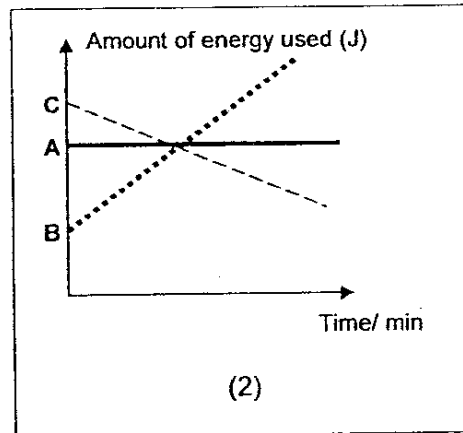
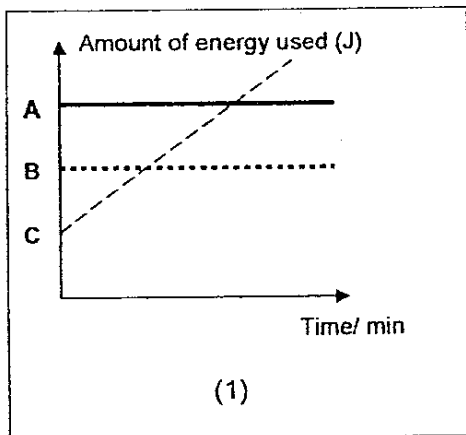

26. Kumar and Sam carried out an experiment to find out which material, A or B, was better for keeping tea warm for a longer time. Kumar and Sam poured an equal amount of hot tea of the same temperature into two identical mugs wrapped with the different types of material.



mug with Material A



mug with Material B

The temperature of the tea in both mugs was taken every 5 minutes and the results are shown in the graph below.

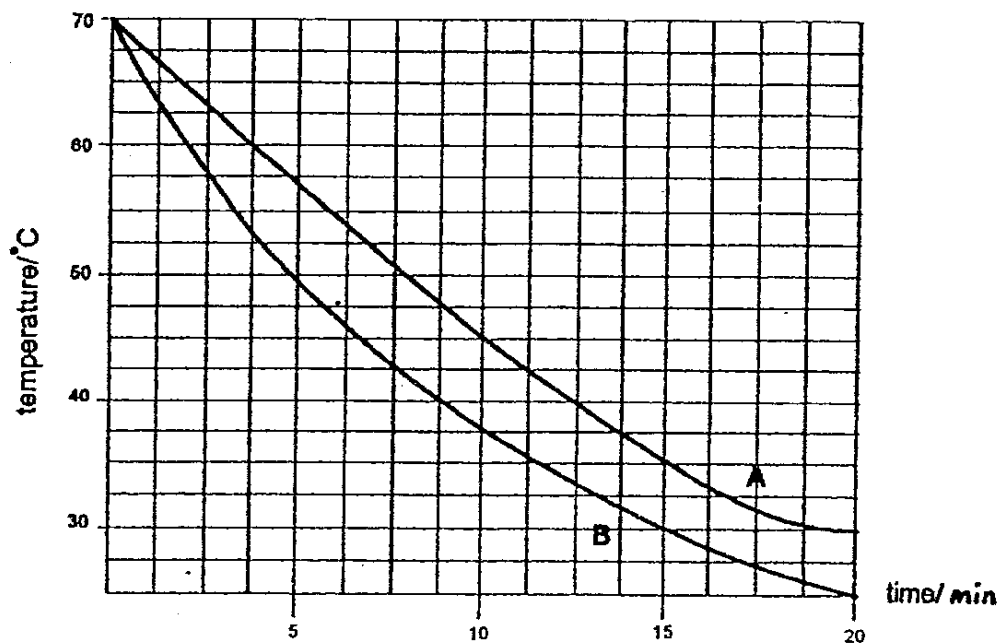

What could Kumar and Sam conclude from their experiment?

- A. Heat is retained better by Material A than by Material B.
- B. Heat is retained better by Material B than by Material A.
- C. Material A transfers heat to its surroundings at a faster rate than Material B.
- D. Material B transfers heat to its surroundings at a faster rate than Material A.

- (1) A and C only
- (2) A and D only
- (3) B and C only
- (4) B and D only

27. The diagram below shows that some electrical appliances can convert electrical energy to other forms of energy.

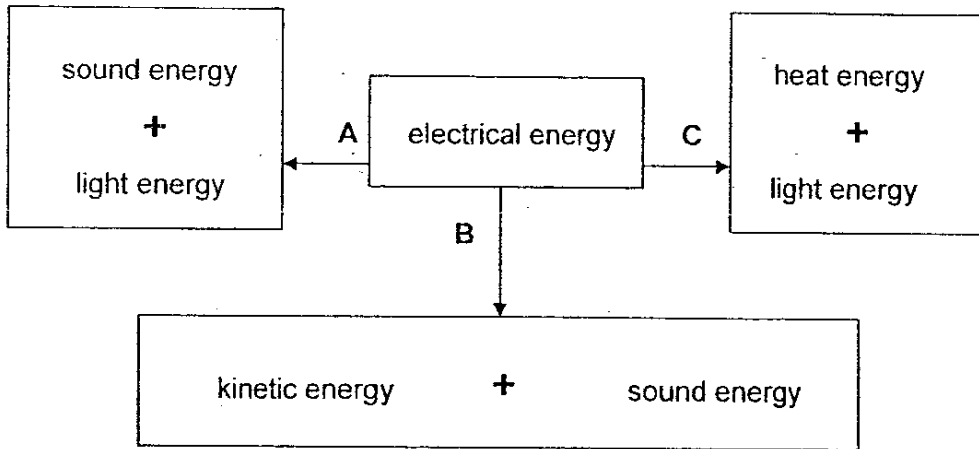

Which one of the following shows correctly what A, B and C represent?

	A	B	C
(1)	television	radio	electric drill
(2)	radio	electric drill	iron
(3)	electric drill	iron	television
(4)	iron	television	radio

28. The diagram below shows a connection of pipes. 3 mirrors are placed inside the pipes.

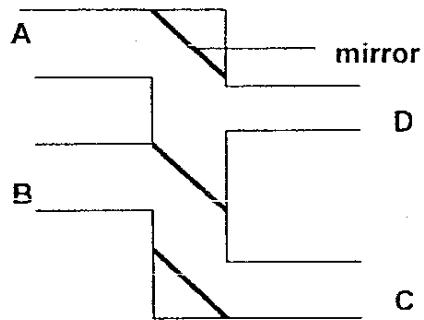

In order to see an object through the pipes, where should the eye and the object be placed respectively?

	Position of object	Position of eye
(1)	A	D
(2)	B	C
(3)	C	A
(4)	D	B

29. The pictures below show the shadows produced when 2 different objects are placed between a screen and the light from a torch. The dimensions of the objects are given in the box on the left.

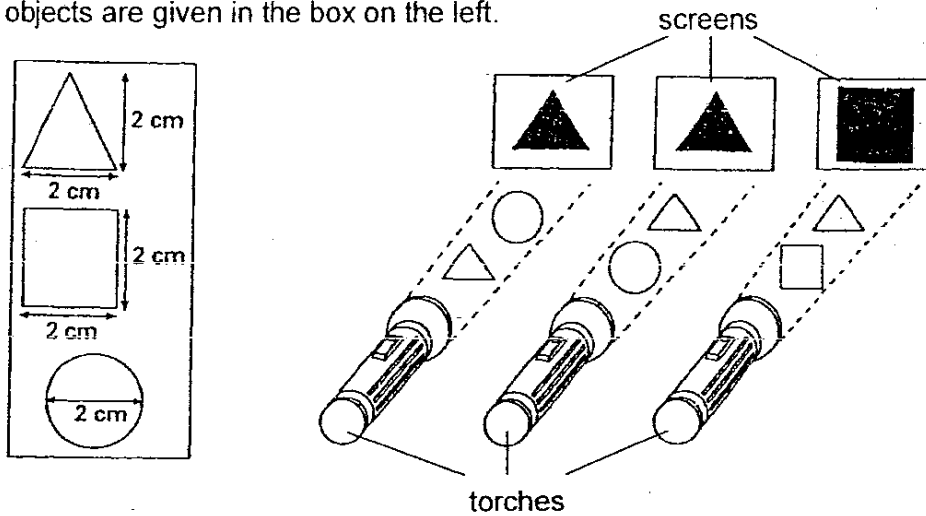

A hole was made in the centre of the circular object and it was placed in front of the screen together with the square object as shown below.

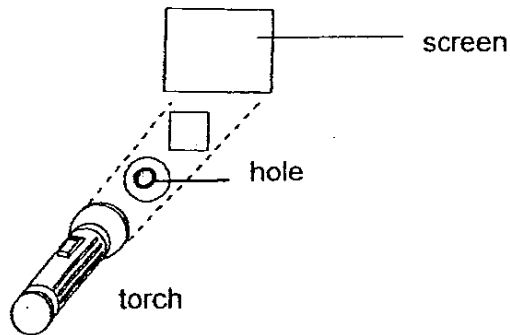

Which one of the following shows the shadow produced on the screen?

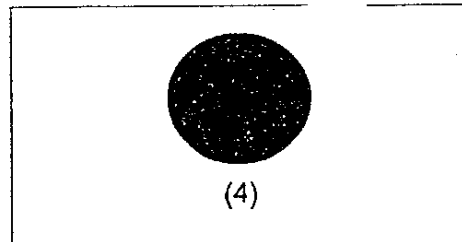
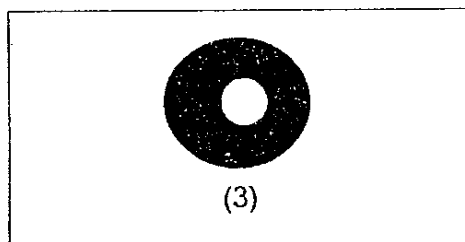
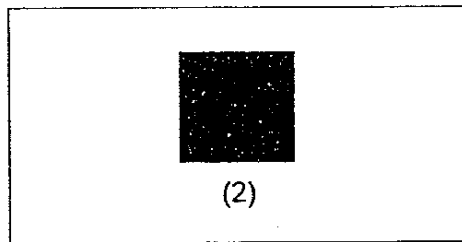
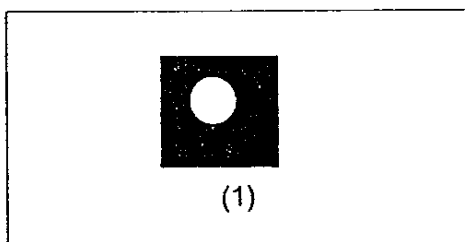

30. In an open field, there are two similar houses, X and Y. The roofs of these houses are made of the different material. Linda selected the two houses to conduct an experiment to find out how the different types of materials can affect the temperature within a house.

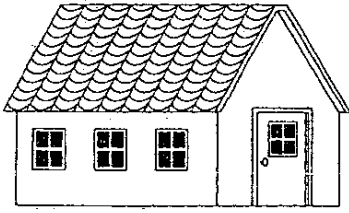

House X

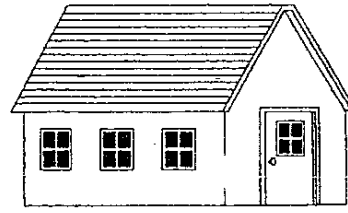

House Y

The temperature within each house was taken every hour for 8 hours. The results are shown in the table below.

Time	9.30 am	10.30 am	11.30 am	12.30 pm	1.30 pm	2.30 pm	3.30 pm	4.30 pm
Temperature In House X ($^{\circ}\text{C}$)	25.5	26.5	27.0	29.5	29.0	29.0	28.5	28.0
Temperature In House Y ($^{\circ}\text{C}$)	25.5	26.0	26.5	27.0	26.5	26.0	25.5	25.0

What are the likely properties of the material used for the roof of House Y?

- A. It is dark-coloured.
- B. It has a shiny surface.
- C. It has a lighter colour than X.
- D. It can absorb heat more quickly than the material used for the roof of House X.

- (1) A and C only
- (2) B and C only
- (3) B and D only
- (4) A, C and D only

SECTION B (40 marks)

There are **16 questions** in this section. Answer **all** of them. Write your answers clearly in the spaces provided.

31. Study the flow chart below.

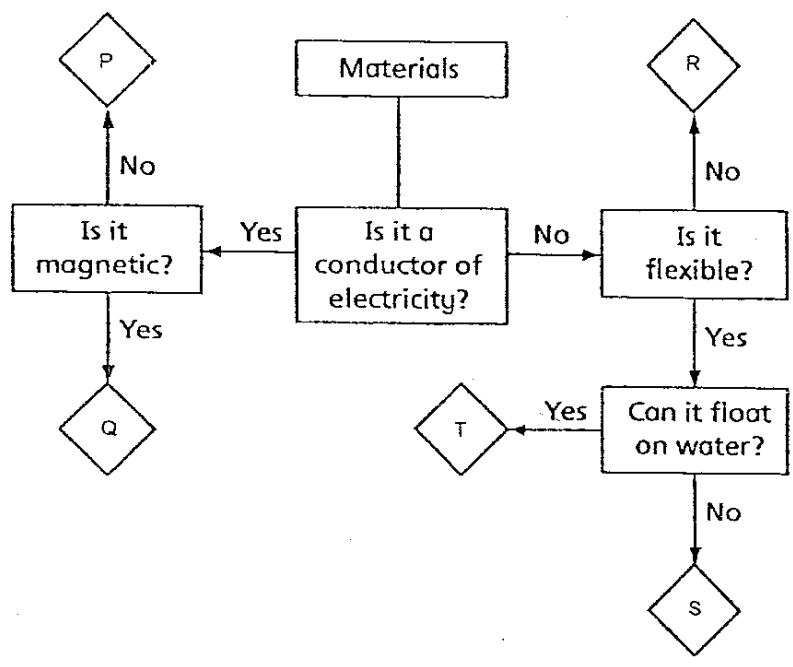

(a) State **two similarities** between materials T and S. [1]

(b) If materials Q and P were each grounded into a powder and mixed together, how could these two materials be separated? [1]

32. Study the chart on animals below.

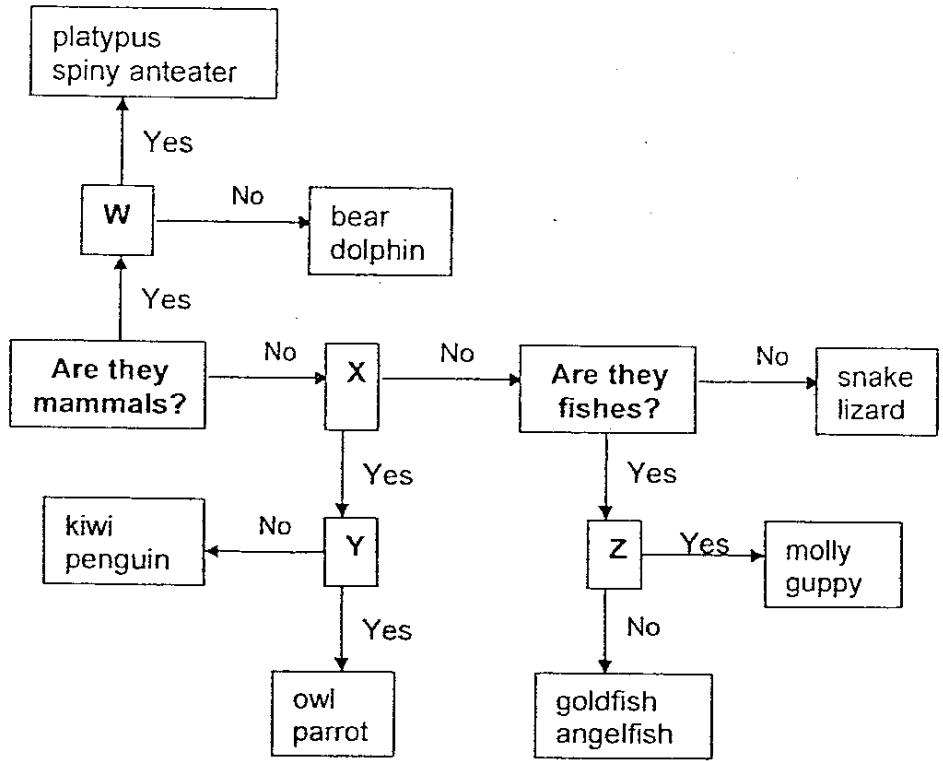

W, X, Y and Z each represents a **different question** that suitably classifies the animals. Write the correct letter W, X, Y or Z in the appropriate boxes below to indicate which question they represent. Each letter can only be used once.

[2]

Question	Letter
Can they fly?	
Can they swim?	
Are they birds?	
Are they insects?	
Do they lay eggs?	
Do they have feathers?	
Do they give birth to their young?	

33. Kimberly put a potato in a dark cupboard. After one week, some shoots were found growing on the potato.

(a) Name the method of reproduction which resulted in the growth of the shoots. [1]

(b) One week later, the potato shoots had grown taller as shown in the picture below.

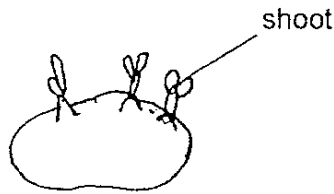

Explain how the shoots managed to grow without sunlight. [1]

34. The family tree below shows members of a family who have Polydactyly and those who do **NOT**. Anyone who carries the genetic material that causes Polydactyly will grow an extra finger or toe. The family tree shows that Jack has Polydactyly but Jill does **NOT**.

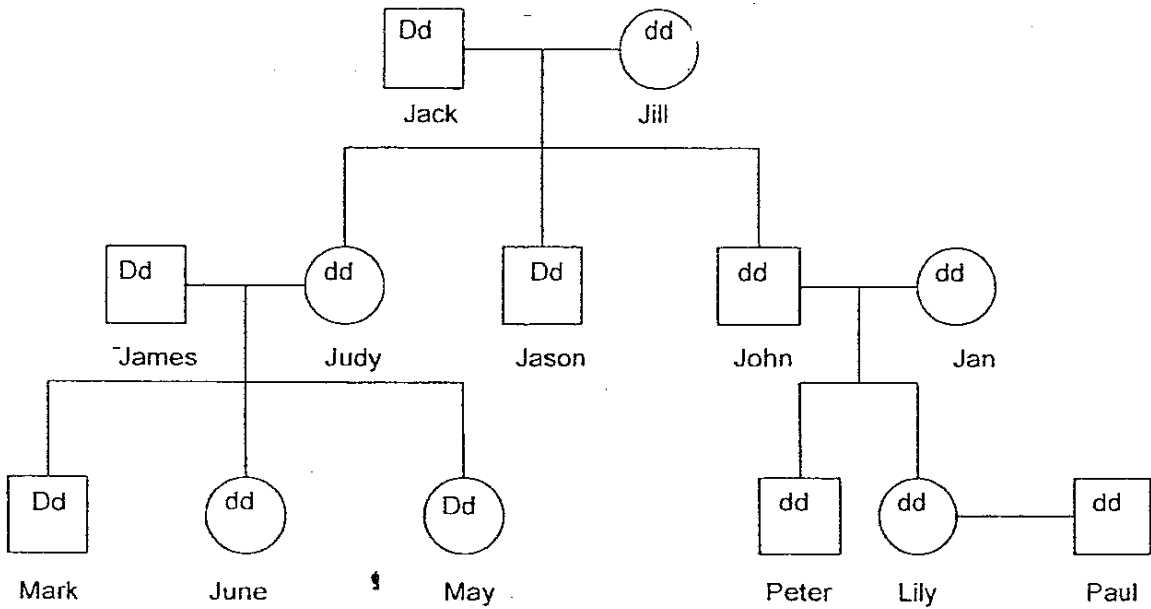

- (a) Which of Jack and Jill's grandchildren has/ have Polydactyly? [1]

- (b) Give the name of Judy's brother who has Polydactyly. Explain why he has Polydactyly. [1]

35. Alan filled Jar A completely with bromine gas (a brown-coloured gas). An identical jar, Jar B, was separated from Jar A with a cardboard in between. When Alan removed the cardboard, the bromine gas spread from Jar A to Jar B.

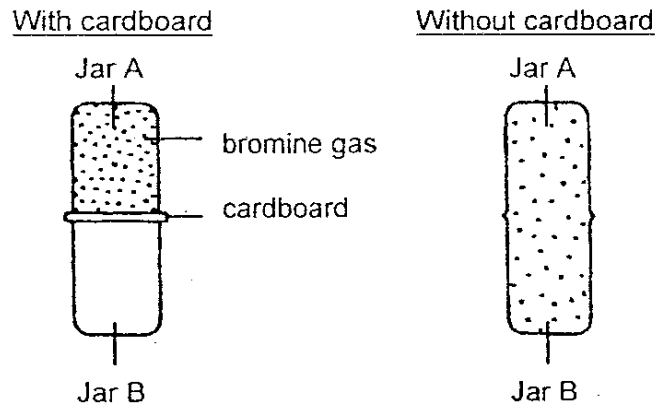

- (a) What does this experiment tell Alan about the volume and shape of gaseous matter? [2]

- (b) Give a reason why Alan did **NOT** choose a colourless gas for this experiment. [1]

36. Two empty containers, A and B, were put under the sun.

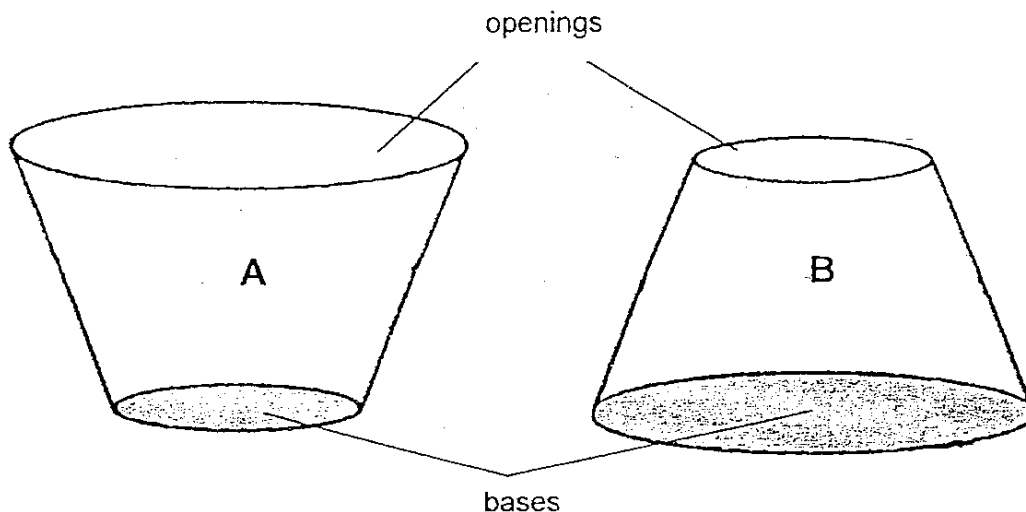

Equal amounts of water were poured into each of the containers.

(a) In which container was the rate of evaporation higher? [1]

Container _____

(b) Give a reason to support your answer in (a).

(c) Meiling commented that if both containers were put in an air-conditioned room, the water would **NOT** evaporate at all.

Is Meiling correct? Why? [1]

37. Bala wants to set up a circuit using the apparatus shown below such that:
- the paper clips would be attracted to the iron nail with electrical wire coiled around it
 - the bulb will light up both when the switch is closed and when it is open

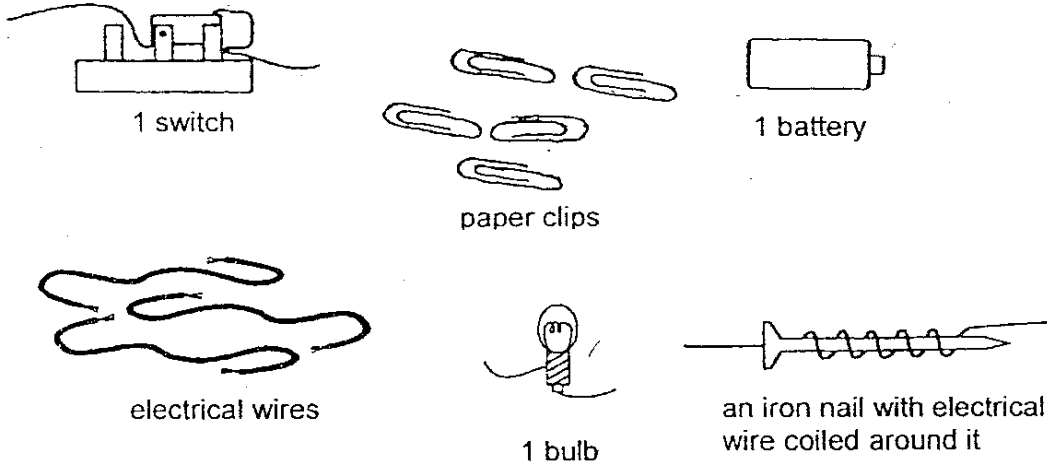

Draw a circuit diagram, using the appropriate **SYMBOLS** for a closed switch, wires, a battery and a bulb, to show how Bala should set up the circuit. The iron nail with electrical wire coiled around it and paper clips have been drawn for you. [2]

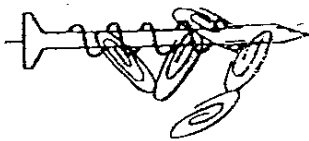

38. Study the picture of the animals below.

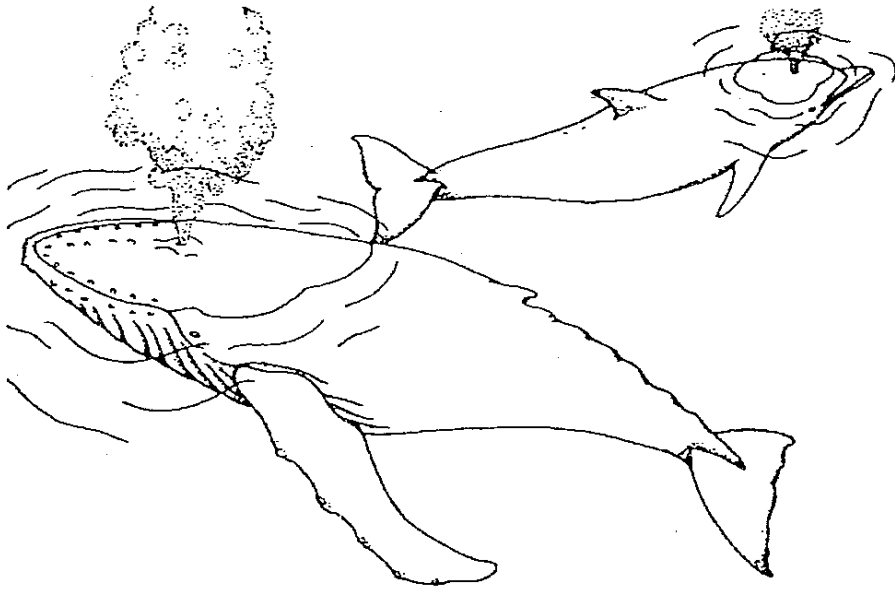

(a) What is the respiratory organ that these animals use for breathing? [1]

(b) Explain how these animals take in air even though they live in water. [1]

39. The diagram below shows part of our digestive system.

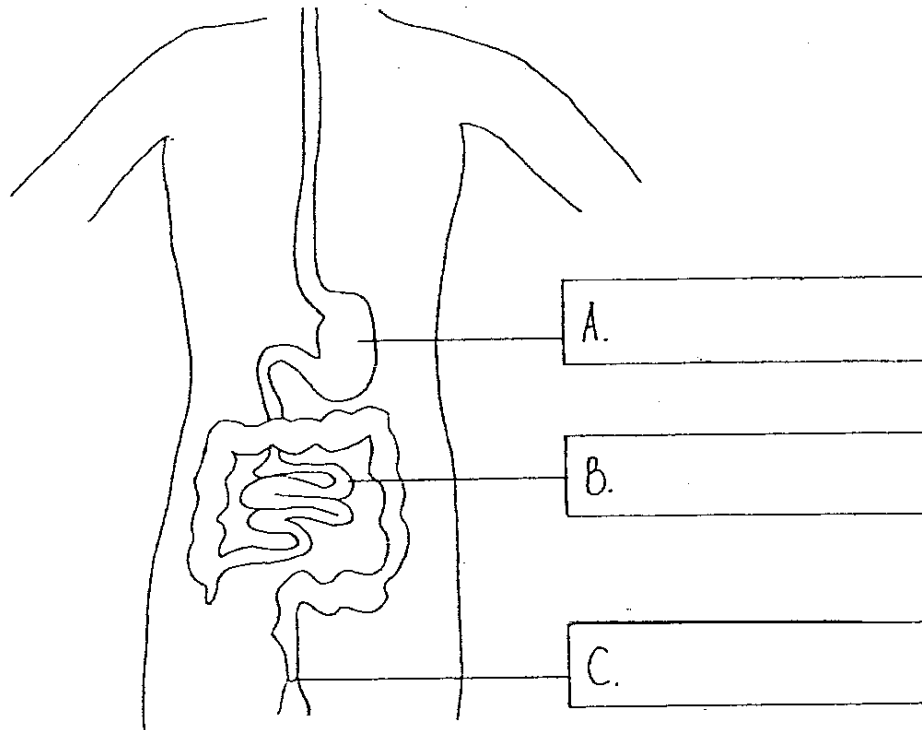

(a) Name the three parts of the digestive system labelled A, B and C in the diagram above. Write their names in the boxes provided. [1½]

(b) Digestion of food also takes place in another part of the digestive system, which is **NOT** shown in the diagram above. Name this part. [1½]

40. Mae set up an experiment as shown in the diagram below.

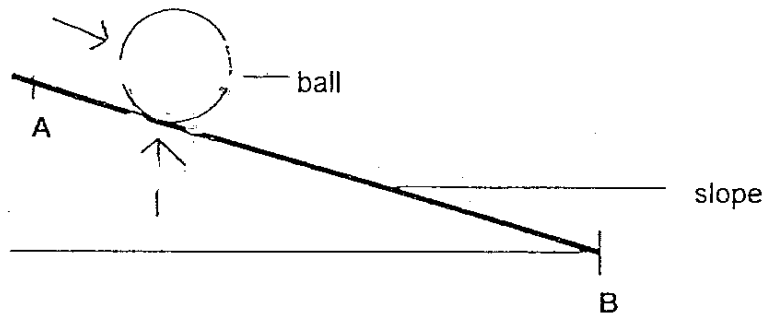

- (a) Using arrows, draw 2 forces acting on the ball when it is rolling down the slope. [1]

Mae covered the surface of the slope entirely with three different types of materials: plastics, sandpaper and wood. For each material, she released the ball at A three times and measured the time taken for the ball to travel to B on the slope.

She recorded her results in the table below.

material covering slope	Time taken for the ball to travel from A to B (s)			
	1 st try	2 nd try	3 rd try	Average time taken (s)
plastics	5	6	4	5
sandpaper	7	8	6	7
wood	6	7	5	6

- (b) What is the aim of Mae's experiment? [1]

- (c) Why are several readings taken for each set-up? [1]

41. The table below shows the number of fishes in Ryan's fish tank from January to April.

Type of fish	Sex	Number of fishes			
		January	February	March	April
swordtail	male	5	5	3	3
	female	3	4	4	3
angelfish	male	2	2	2	2
	female	0	0	0	0
goldfish	male	6	5	6	8
	female	6	4	5	7
Total		22	20	20	23

Study the statements in the following table carefully and state whether they are TRUE (T), FALSE (F) or NOT POSSIBLE TO TELL (N).

Write only the letters T, F or N, in the boxes below.

[2]

There are 20 populations of fish in March.	
The decrease in the number of goldfish from January to February is due to the presence of disease-causing organisms.	
The population size of the swordtail is always greater than the population size of the angelfish from January to April.	
The number of angelfish remains constant throughout the four months.	

42. Ethan set up the equipment as shown below.

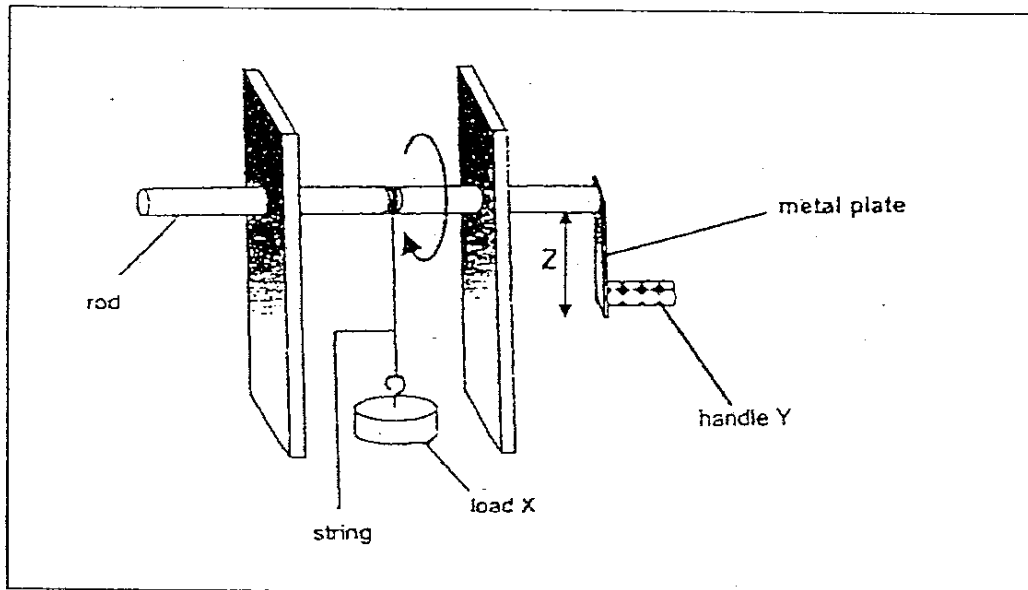

(a) What kind of a simple machine has he set up?

[1] ○

When Ethan turns handle Y, load X is lifted.
 If metal plates of different lengths are used, the amount of effort needed to lift load X will change.

The table below shows the amount of effort needed to lift load X using metal plates of different lengths.

Length of metal plate, Z (cm)	Effort needed to lift load X (g)
10	150
20	100
30	50

- (b) Using the data Ethan recorded in the table on page 38, draw the graph below. [2]

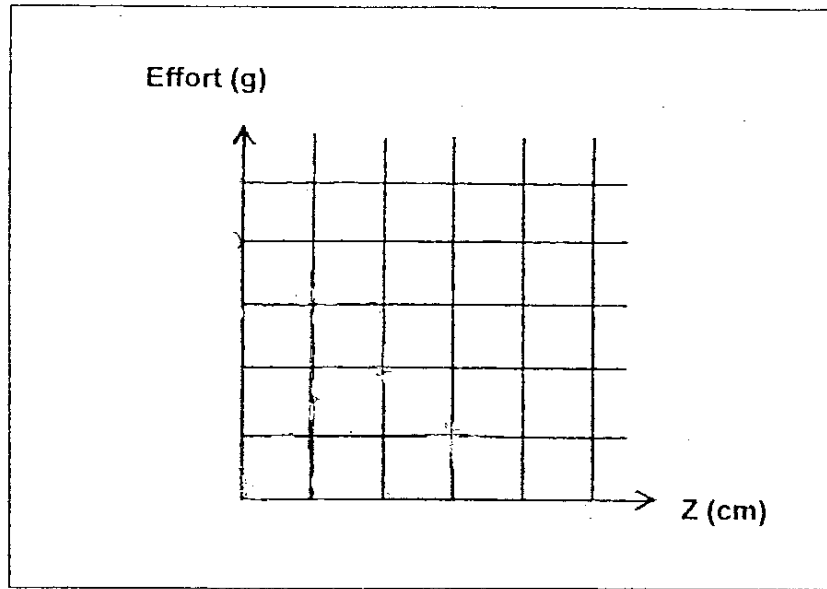

- (c) From the data given, what can you conclude about the length of the metal plate and the effort needed to lift load X? [1]

43. Angie had 2 magnets, A and B, as shown below.



Magnet A

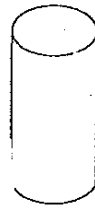

Magnet B

She also found the following apparatus in the laboratory:

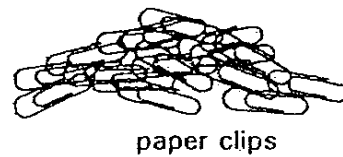
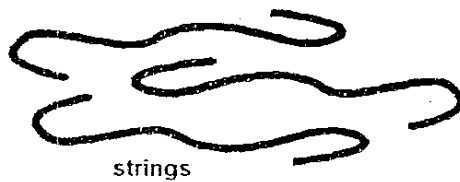
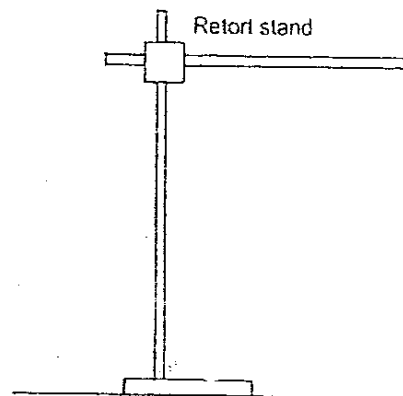
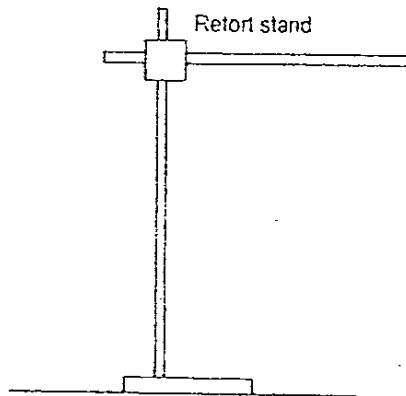

- (a) Using **only** the apparatus given on page 40, complete the diagrams below to show how Angie can compare the strength of the magnets. The retort stands have been drawn for you.

Label your diagrams **clearly**.

[2]

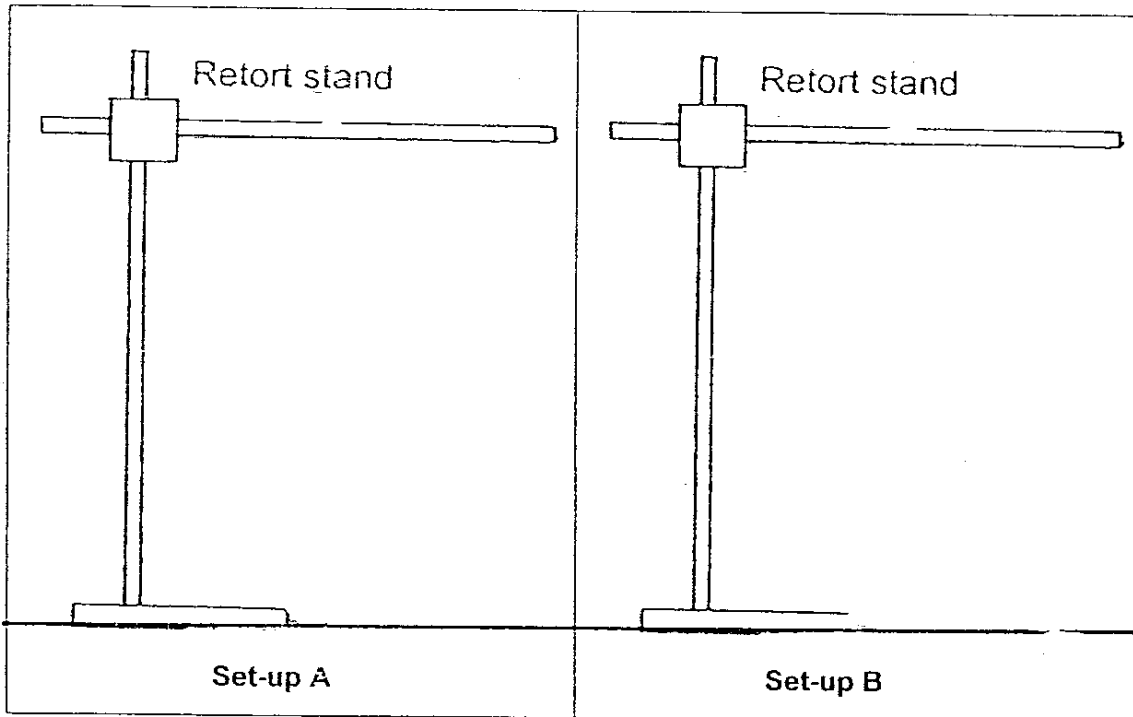

- (b) Angie found a piece of paper in the laboratory. Using one of the set-ups above, what should she do to find out if paper allows magnetic force to pass through? [1]

44. Kim Lan bounced a ping-pong ball off a table as shown in the diagram below.

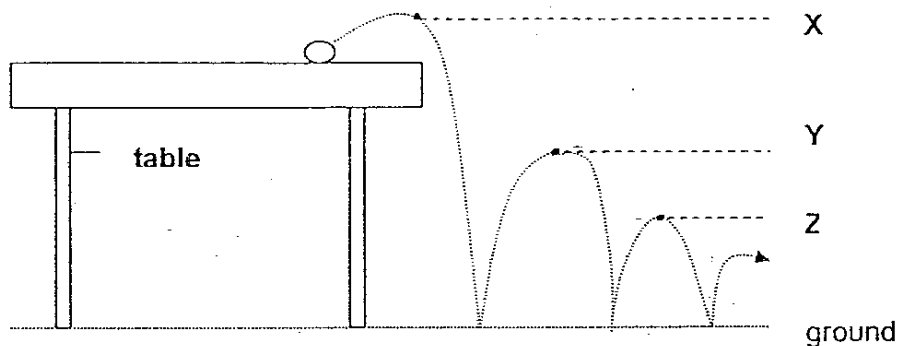

(a) Kim Lan observed that the ping-pong ball bounced off the table and dropped onto the ground below. She also noticed that the ping-pong ball bounced up to a lower height after each time it hit the ground.

Explain why this is so.

[1]

(b) At which point(s), X, Y or Z, did the ping-pong ball have the most gravitational potential energy?

[1]

^

45. A bell was connected to a battery as shown below.

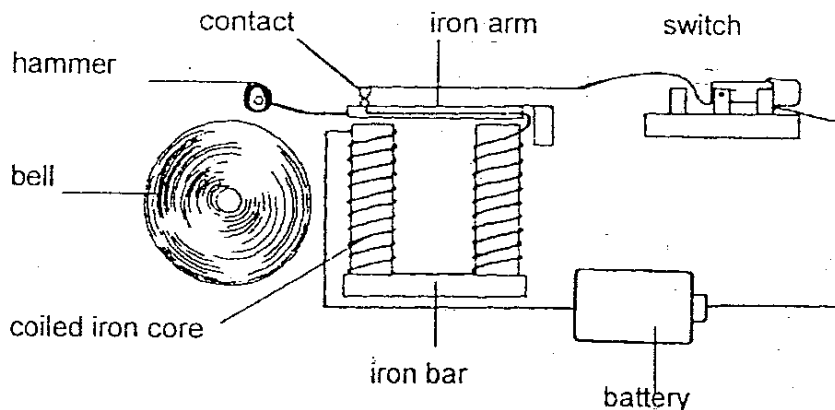

When the switch was closed, the bell made a sound.

(a) What energy changes occur for the bell to make the sound? [1]

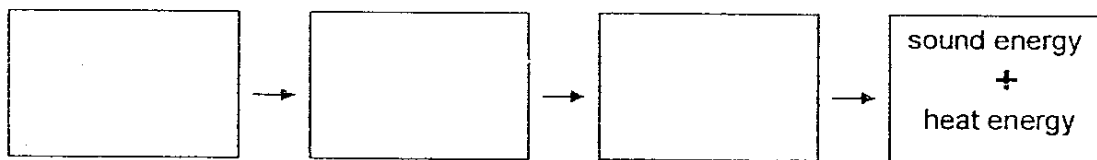

(b) What caused the iron arm to move away from the contact when the switch was closed? [1]

46. The vanes of the science toy shown in Figure A will spin when the sun shines on the toy.

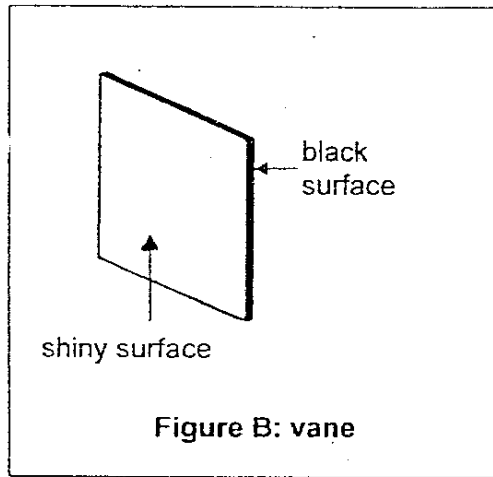
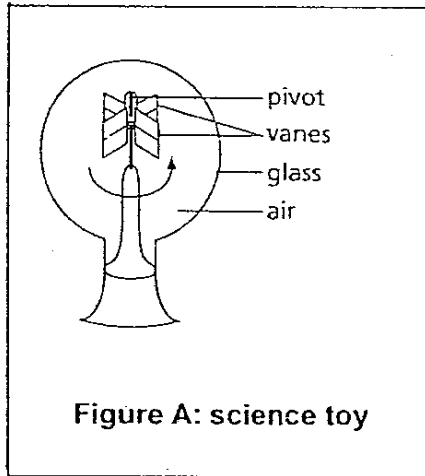

Figure B shows a close-up view of a single vane taken from the toy. The vanes begin to spin when one side of each vane becomes warmer than the other.

- (a) Which side, the shiny surface or the black surface, becomes warmer first when the sun shines on the toy? [1]

- (b) Give a reason for your answer in (a). [1]

- (c) Suggest a suitable material to make the vanes. [1]

- END OF PAPER -

Raffles Girls' Primary School
Primary 6 Science SA1 Exams (2006)

(ANSWER KEY)

SECTION A : (60 MARKS)

Qn no.	Ans
1	4
2	2
3	3
4	3
5	4
6	2
7	1
8	4
9	4
10	1

Qn no.	Ans
11	2
12	3
13	1
14	3
15	4
16	3
17	3
18	4
19	1
20	1

Qn no.	Ans
21	2
22	1
23	3
24	2
25	3
26	2
27	2
28	2
29	2
30	2

SECTION B (40 MARKS)

Qn No.	Answers
31a	Both of them are flexible and are not conductor of electricity.
31b	We can use a magnet to separate them. Only material Q will attract to the magnet as it is a magnetic material. Material P will not get attracted to the magnet as it is not a magnetic material. Thus, it will remain there.

32	Can they fly ? \longrightarrow Y
	Are they birds ? \longrightarrow X
	Do they lay eggs ? \longrightarrow W
	Do they give birth to their young \longrightarrow Z

33a	Asexual reproduction
33b	The shoots obtained food from the potato.

34a	Mark and May
34b	Jason. Jason has Polydactyly as he carries the genetic material that causes Polydactyly from his father.

Qn No.	Answers
35a	Gas has no definite shape and volume. It takes up all the space in the container and also takes the shape.
35b	Alan will not be able to see if the gas will spread from jar A to jar B. Hence, the experiment will not be accurate.

36a	A
36b	A has a larger opening than B.
36c	No. Evaporation can occur any time and at any temperature.

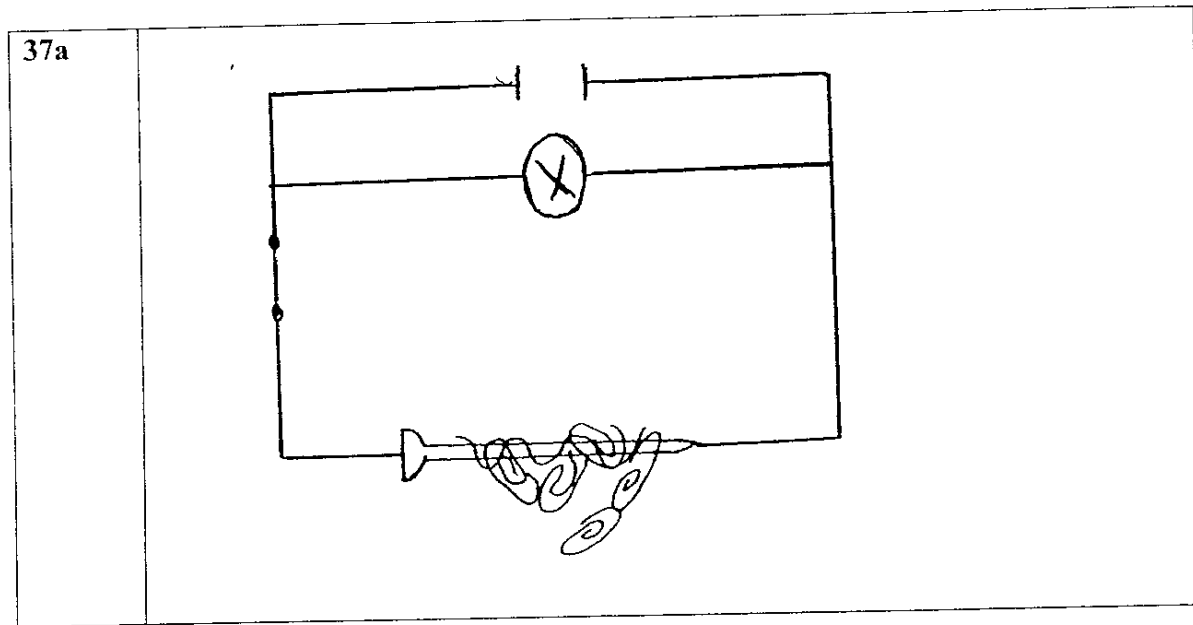

38a	Lungs
38b	They will come up to the surface of the water to take in air and go back down again, once they are done.

39a	A : stomach B : small intestine C : anus
39b	mouth

Qn No.	Answers
40a	<p>b) Mountain.</p> <p>40) a)</p>
40b	To find out which type of material will allow the B to travel down the slope faster.
40c	It is to ensure that her experiment is accurate.

41	False
	Not possible to tell
	True
	True

42a	Wheel and axle
42b	<p>b)</p>
42c	The bigger the metal plate, the lesser the effort needed to lift the load.

Qn No.	Answers
43a	
43b	She should put the paper between the magnets and the paper clips to see if the paper clips will still get attracted to the magnets.

44a	Some of the ping-pong ball's kinetic energy is being converted to sound as well as heat energy. Some of kinetic energy is also used to overcome friction and gravity.
-----	---

44b	Point X
-----	---------

45a	Chemical potential energy \longrightarrow electrical energy \longrightarrow kinetic energy \longrightarrow Sound energy + heat energy
-----	--

45b	The iron cores became magnetized and attracted the iron arm to move away from the contact when the switch was closed.
-----	---

46a	Black surface
46b	The shiny surface will reflect the light while the black surface will absorb the light.
46c	Aluminium