

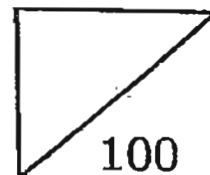

**Rosyth School**  
**First Continual Assessment for 2011**  
**STANDARD SCIENCE**  
**Primary 6**



Name: \_\_\_\_\_

Total  
Marks:

Class: Pr \_\_\_\_\_

Register No. \_\_\_\_\_

Duration: 1 h 45 min

Date: 3<sup>rd</sup> March 2011

Parent's Signature: \_\_\_\_\_

---

## Booklet A

Instructions to Pupils:

1. Do not open the booklets until you are told to do so.
2. Follow all instructions carefully.
3. This paper consists of 2 booklets, Booklet A and Booklet B.
4. For questions 1 to 30 in Booklet A, shade the correct ovals on the Optical Answer Sheet (OAS) provided using a 2B pencil.
5. For questions 31 to 44, give your answers in the spaces given in the Booklet B.

	<b>Maximum</b>	<b>Marks Obtained</b>
<b>Booklet A</b>	<b>60 marks</b>	
<b>Booklet B</b>	<b>40 marks</b>	
<b>Total</b>	<b>100 marks</b>	

\* This booklet consists of   16   pages . (Pg. 1 to 16)

This paper is not to be reproduced in part or whole without the permission of the Principal.

For each question from 1 to 30, four options are given. One of them is the correct answer. Make your choice (1, 2, 3 or 4). Shade the correct oval (1, 2, 3 or 4) on the Optical Answer Sheet.

1 The diagram below shows the life cycle of an animal.

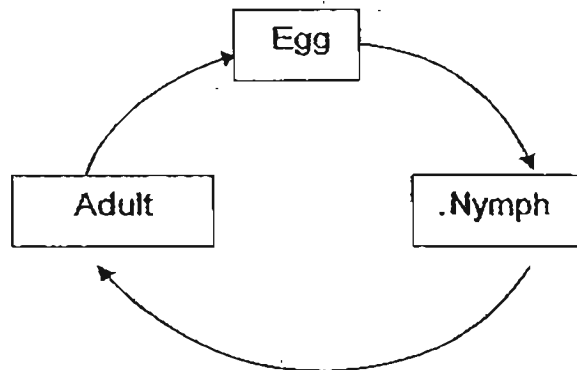

Which of the following animals goes through the life cycle as shown above?

- A: Frog
- B: Mealworm Beetle
- C: Cockroach
- D: Grasshopper

- (1) A only
- (2) B only
- (3) B and D only
- (4) C and D only

2 The table below compares the life cycle of the butterfly and that of the mosquito.

		Butterfly	Mosquito
A	4 stages in life cycle	√	√
B	Lays eggs in dark places	√	√
C	The young resembles the adult	X	X
D	It is a pest during the larval stage	X	√

Which of the following comparisons are correct?

- (1) A and B only
- (2) A and C only
- (3) B and C only
- (4) C and D only

3 Which one of the following shows the correct order of stages and processes in the life cycle of a flowering plant?

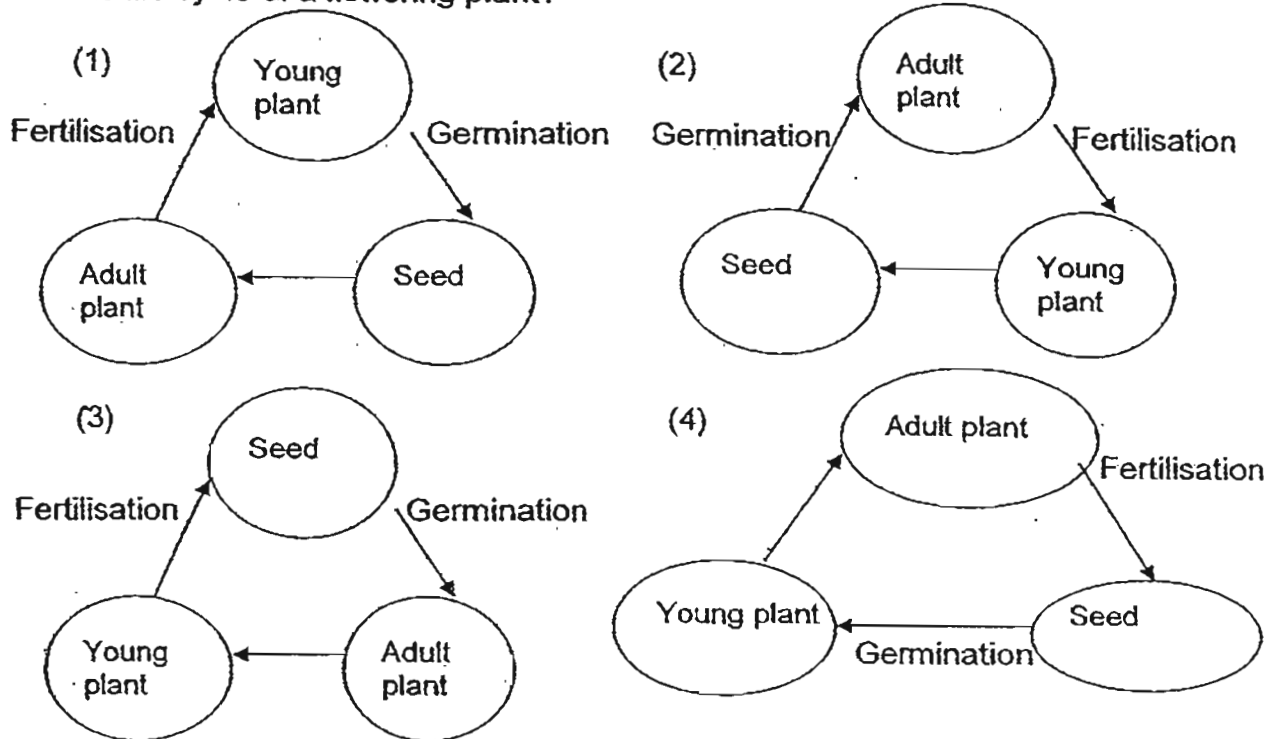

4 The table below shows the classification of animals.

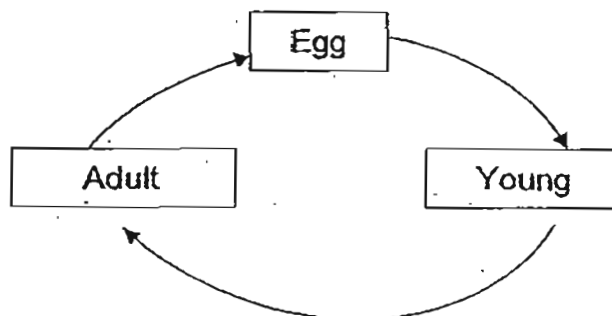
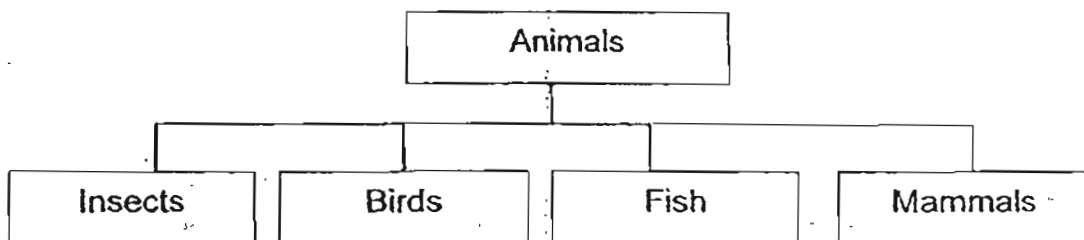

Which group of animals may not have a similar life cycle as shown above?

- (1) Insects
- (2) Birds
- (3) Fish
- (4) Mammals

- 5 The following table provides information on 4 animals, E, F, G and H, based on two characteristics. A tick (✓) shows that the animal has the characteristics.

Animals \ Characteristics	E	F	G	H
Herbivore		✓		✓
Live on land		✓	✓	

From the information above, where will you put Animal E, F, G, and H in the following classification table below?

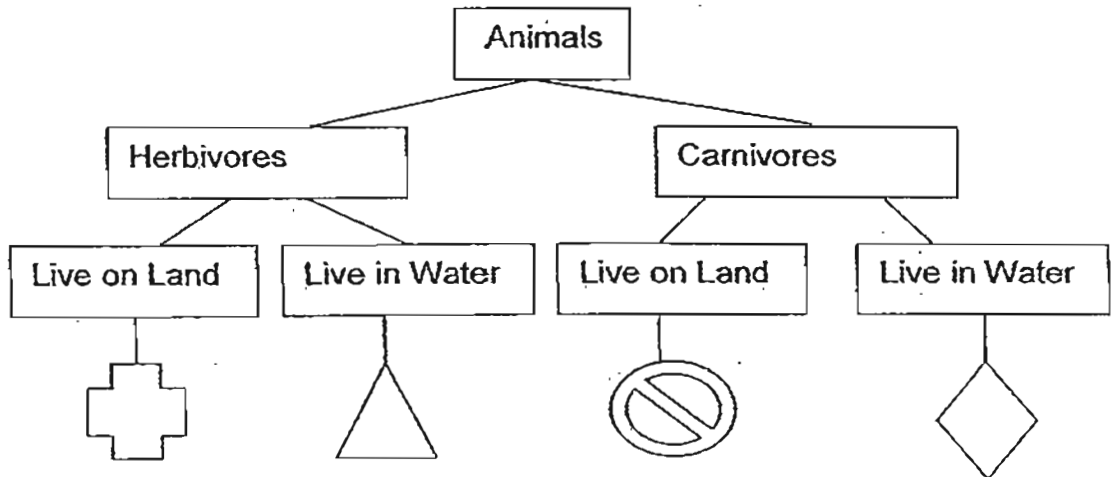

	Animal E	Animal F	Animal G	Animal H
(1)	△	⊘	+	◇
(2)	+	△	◇	⊘
(3)	◇	+	△	⊘
(4)	◇	+	⊘	△

- 6 The diagram below shows a developing baby in a woman's body. P is part of the reproductive system.

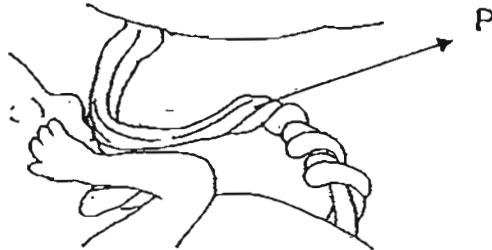

Which other system can part P belong to?

- |                      |                        |
|----------------------|------------------------|
| (1) Digestive System | (2) Skeletal System    |
| (3) Muscular System  | (4) Circulatory System |
- 7 The diagram below shows a human reproductive system.

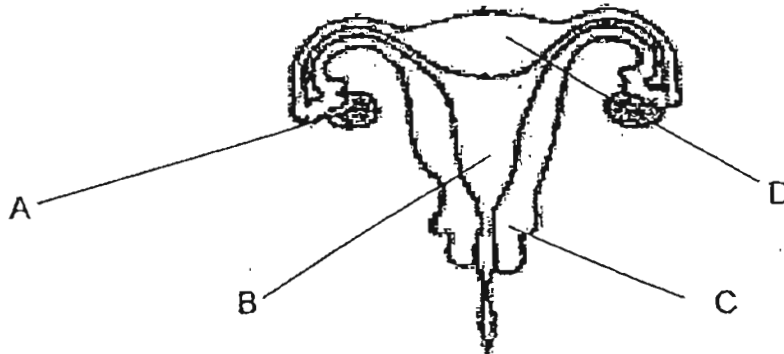

Which part of the above reproductive system produce egg cells?

- |       |       |
|-------|-------|
| (1) A | (2) B |
| (3) C | (4) D |

- 8 The graph below shows the changes the uterus undergoes over a period of time.

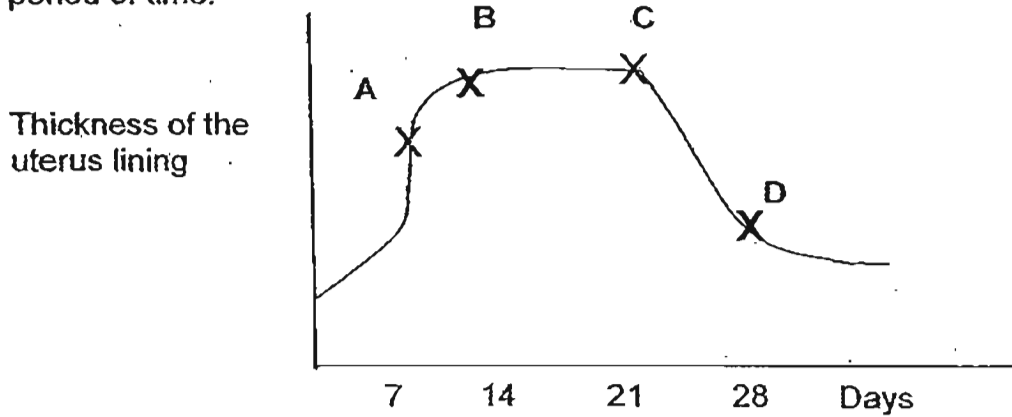

At which point of the graph (A, B, C or D), the body has identified that egg is not fertilised?

- (1) A (2) B  
(3) C (4) D
- 9 The boxes below describe the characteristics of a family.

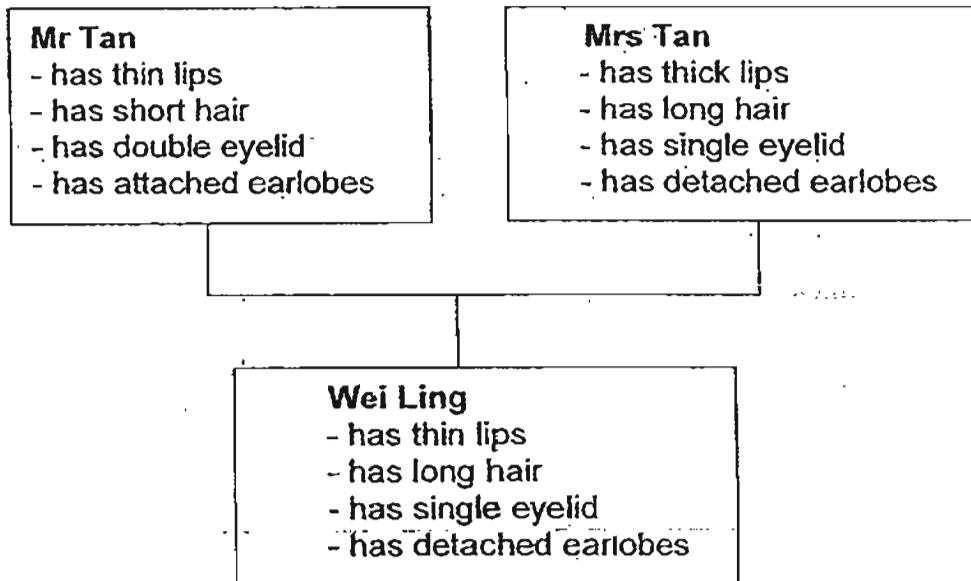

Which of the following characteristics did Wei Ling inherit from her mother?

- (1) Single eyelid and long hair  
(2) Single eyelid and detached earlobes  
(3) Detached earlobes and long hair  
(4) Detached earlobes and thick lips

10 The diagram below shows the fruit of some plants.

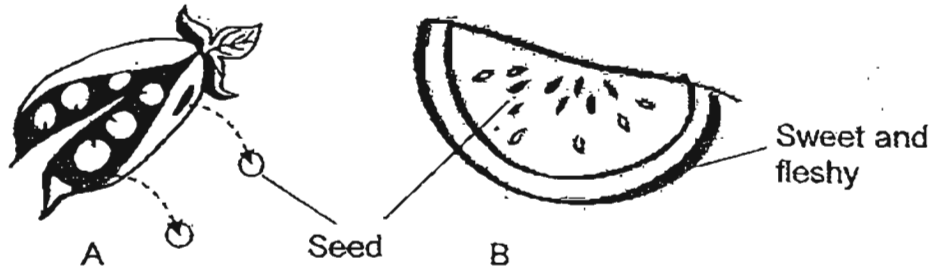

How are fruits, A and B dispersed?

	A	B
(1)	Wind	Animals
(2)	Animals	Wind
(3)	Animals	Splitting Action
(4)	Splitting Action	Animals

11 Four set-ups, A, B, C and D were prepared using similar types of seeds with different conditions as shown in the table below.

Set-up	Type of Cotton Wool	Where it is placed
A	moist	in the freezer
B	moist	near an open window
C	Moist Dry	<del>in a closed cabinet</del>
D	Dry	near an open window

*+ have warmth and air in oven 40°C*

Which set-up should Janet use as a control if she wanted to test if seeds need warmth to germinate?

- |       |       |
|-------|-------|
| (1) A | (2) B |
| (3) C | (4) D |

12 Ali planted same types of seeds in the two containers as shown below.

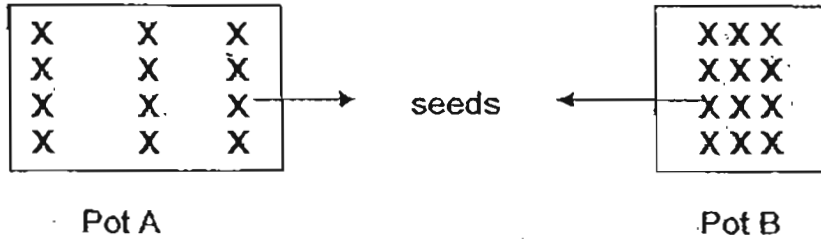

Which variable in the above set-up is being investigated?

- A: Amount of air
- B: Amount of space
- C: Number of seeds

- (1) A only
- (2) B only
- (3) A and B only
- (4) B and C only

13 Study the flow chart below. It shows the characteristics of different plants, E, F, G and H.

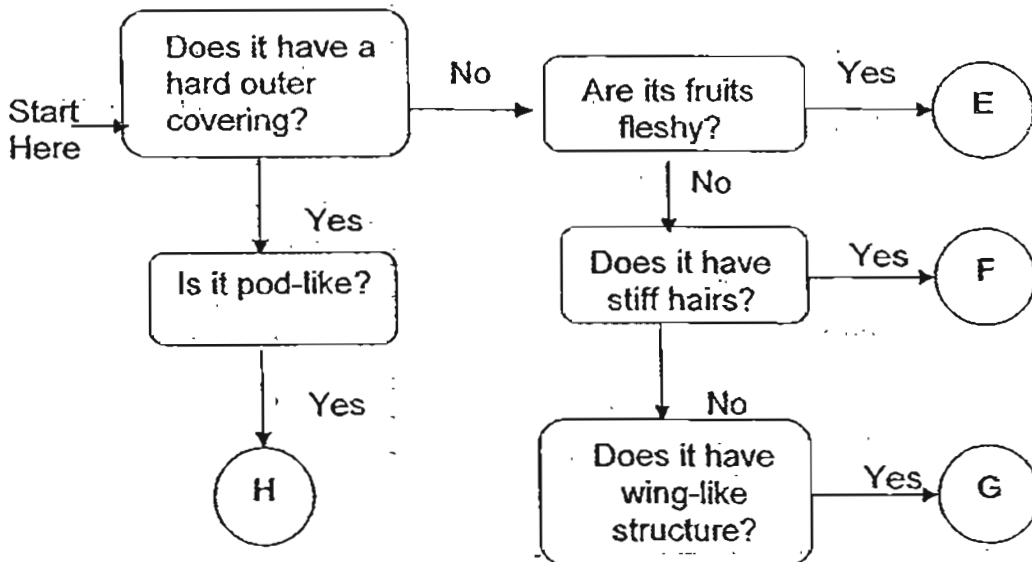

Based on the flow chart, which of the following young plant is the most likely to grow near its parent plant?

- (1) E
- (2) F
- (3) G
- (4) H



14 Ali carried out the following steps.

Step	Action taken
1	Filled two flower pots of same sizes with the same amount of garden soil
2	Planted same number of two types of bean seeds in each pot
3	Placed all the pots in the garden
4	Poured 25ml of water in each pot daily

Which of the following could be the aim of Ali's experiment?

It is to find out if \_\_\_\_\_

- (1) sunlight affects the growth of the plants
- (2) garden soil affects the growth of the plants
- (3) types of beans affect the growth of the plants
- (4) amount of water affects the growth of the plants

15 Various parts of a hibiscus plant were removed in an experiment as shown in the table below.

Group	Parts removed
W	Petals only
X	Stigmas only
Y	Anthers only
Z	Ovules only

Pollen grains from an intact flower were collected and dusted on the remaining parts of the four groups of flowers.

In which group(s) of flowers will the process of fertilisation take place?

- |                  |                     |
|------------------|---------------------|
| (1) W only       | (2) X and Z only    |
| (3) W and Y only | (4) W, X and Z only |

16 The diagram below shows a concept map.

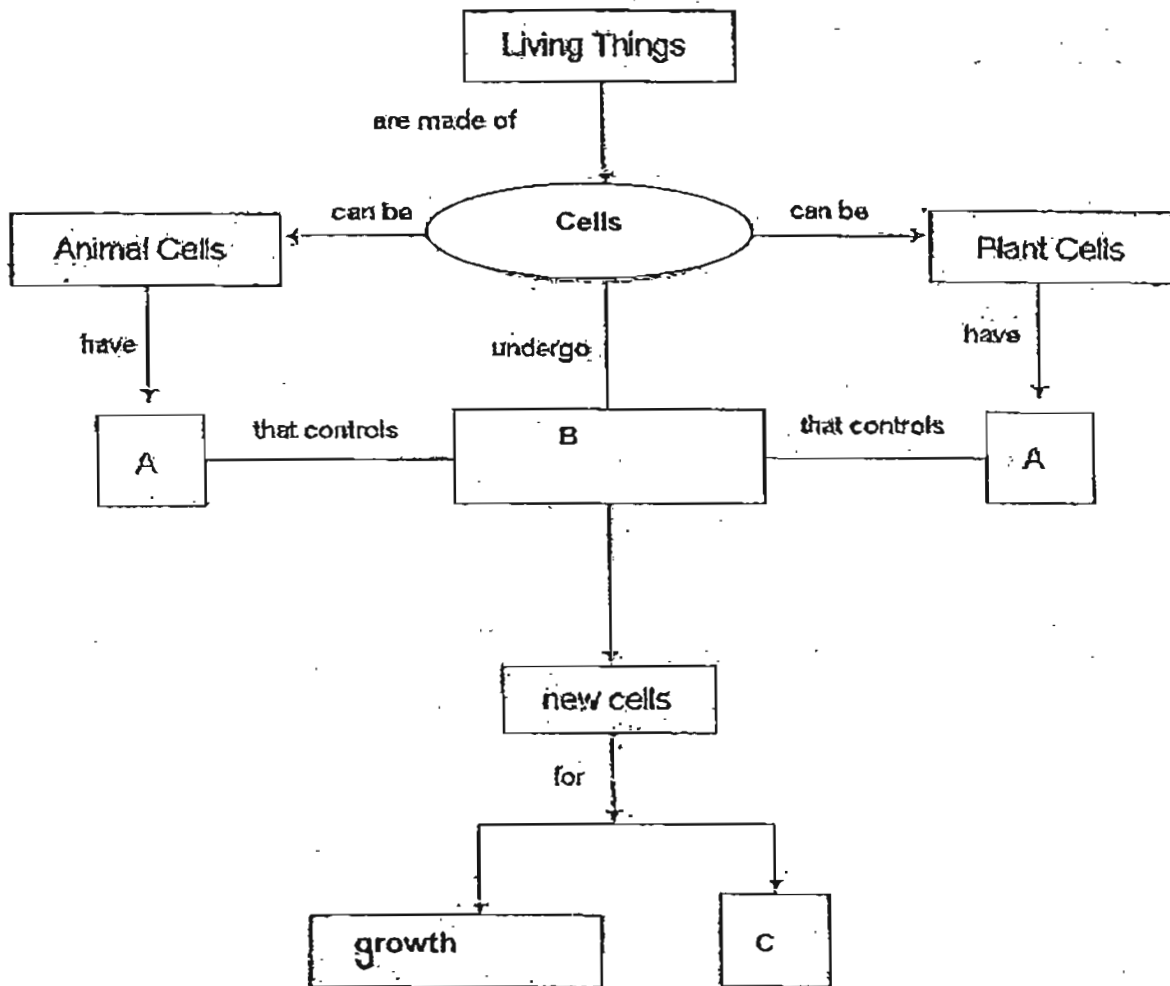

Which of the following best represents A and B and C?

	A	B	C
(1)	cytoplasm	respiration	repair
(2)	cell membrane	movement of substances	reproduction
(3)	vacuole	fertilisation	continuity of life
(4)	nucleus	cell division	replacement



20 The graphs below show the changes in the temperature of water. Which graph shows water in all three states?

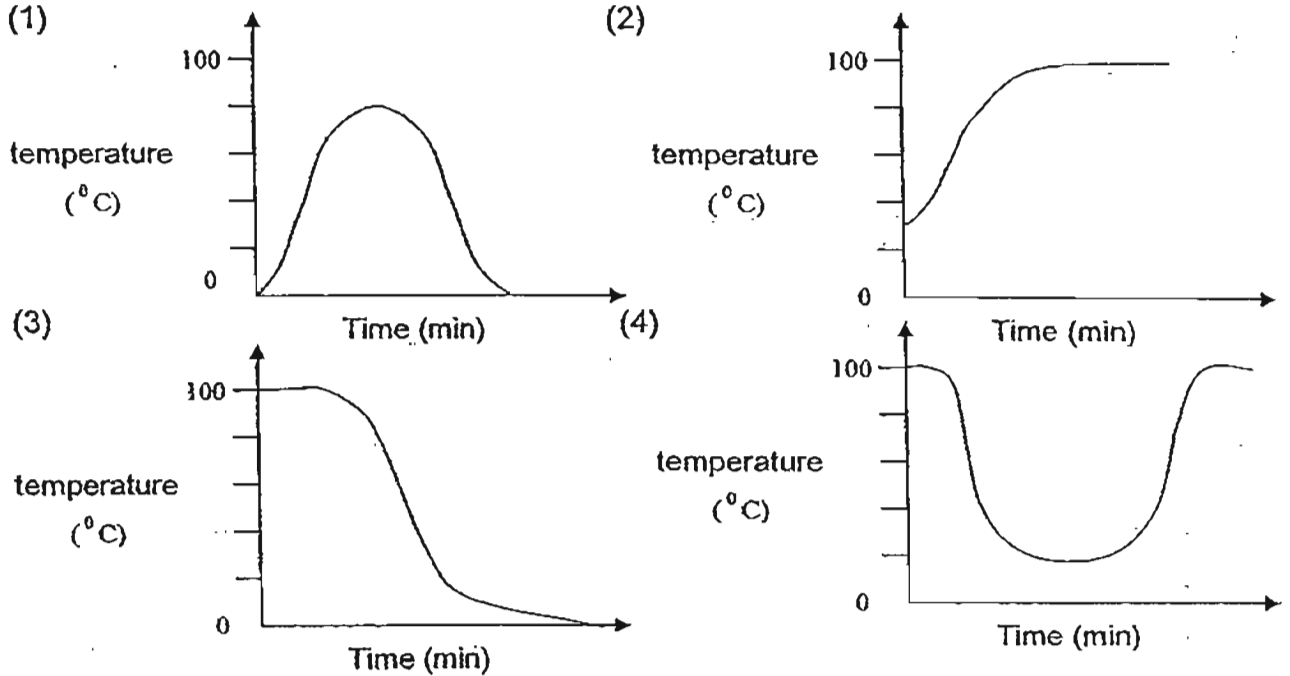

21 Felix wanted to find out if temperature affects the rate by which wet towels dry. He used two towels of the same material. He listed all the other variables that will affect his experiment as shown below:

- A: The amount of water used to soak the towels
- B: The size of the towels
- C: The places where the towels were hung
- D: The temperature of the surroundings

Which of the following show the correct choice for his experiment?

	Kept the same variable	Changed variables
(1)	A, B and C	D
(2)	A, B and D	C
(3)	A, C and D	B
(4)	B, C and D	A

- 22 The diagram below shows the three states of water. A, B, C and D represent four different processes.

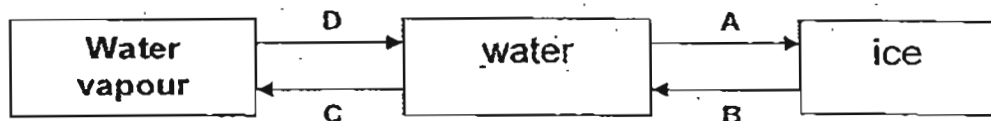

Which one of the following correctly indicates whether heat is gained or lost during the processes A, B, C and D?

	A	B	C	D
(1)	Heat is lost	Heat is gained	Heat is gained	Heat is lost
(2)	Heat is lost	Heat is gained	Heat is lost	Heat is gained
(3)	Heat is gained	Heat is lost	Heat is gained	Heat is lost
(4)	Heat is gained	Heat is lost	Heat is lost	Heat is gained

- 23 The graph below shows how the temperature of two beakers of water, X and Y, changes over time.

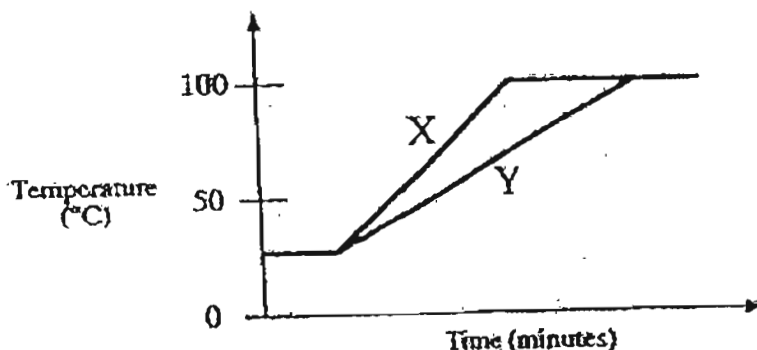

Study the graph above carefully. Which one of the following statements interprets the graph correctly?

- (1) Beaker X contained less water than Beaker Y.  
 (2) Both beakers of water boiled at the same time.  
 (3) Beaker X is a poorer conductor of heat than Beaker Y.  
 (4) Beaker Y was heated over a stronger flame than Beaker X.
- 24 Which of the following can be a part of the water cycle?

- A: melting of snow  
 B: sweating of animals  
 C: giving out of water vapour by plants  
 D: evaporation of water from rivers

- (1) D only  
 (2) A and C only  
 (3) A, C and D only  
 (4) A, B, C and D

- 25 Chris prepared two cups, P and Q, of water and then covered them. The diagram below shows what was observed after 2 minutes.

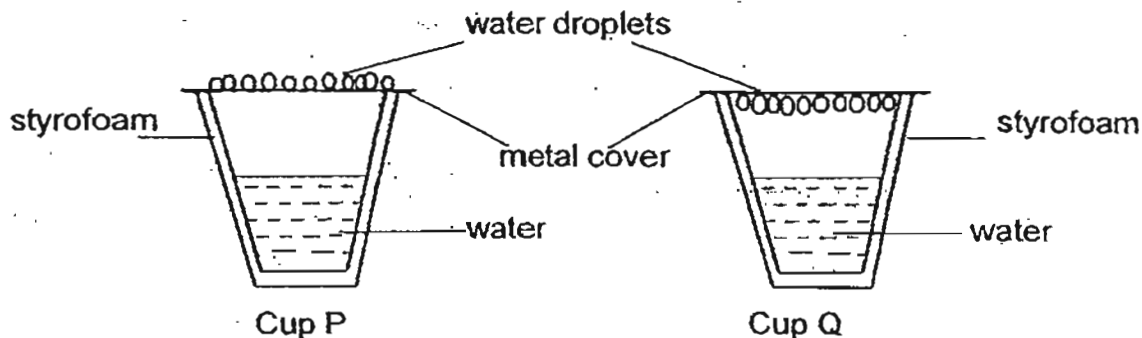

Which one of the following shows the likely temperatures of water in cups P and Q?

	Cup P ( $^{\circ}\text{C}$ )	Cup Q ( $^{\circ}\text{C}$ )
(1)	30	30
(2)	5	70
(3)	70	5
(4)	70	70

- 26 Peter wanted to test the accuracy of his digital thermometer. He put his thermometer in a beaker of melting ice. The reading on his thermometer was  $3.2^{\circ}\text{C}$  as shown in the diagram below.

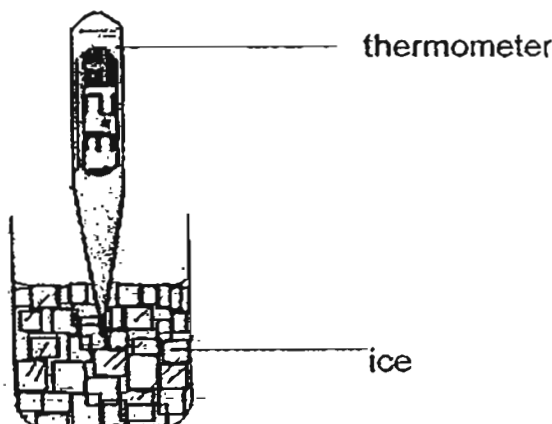

He then measured the temperature in his refrigerator. The thermometer reading showed  $6.8^{\circ}\text{C}$ .

What is the actual temperature in the refrigerator?

- (1)  $0^{\circ}\text{C}$  (2)  $3.6^{\circ}\text{C}$   
 (3)  $6.8^{\circ}\text{C}$  (4)  $10.0^{\circ}\text{C}$

27 Janet made a hypothesis that there are particles in a garden soil which are soluble in water.

She carried out the following steps for her investigation:

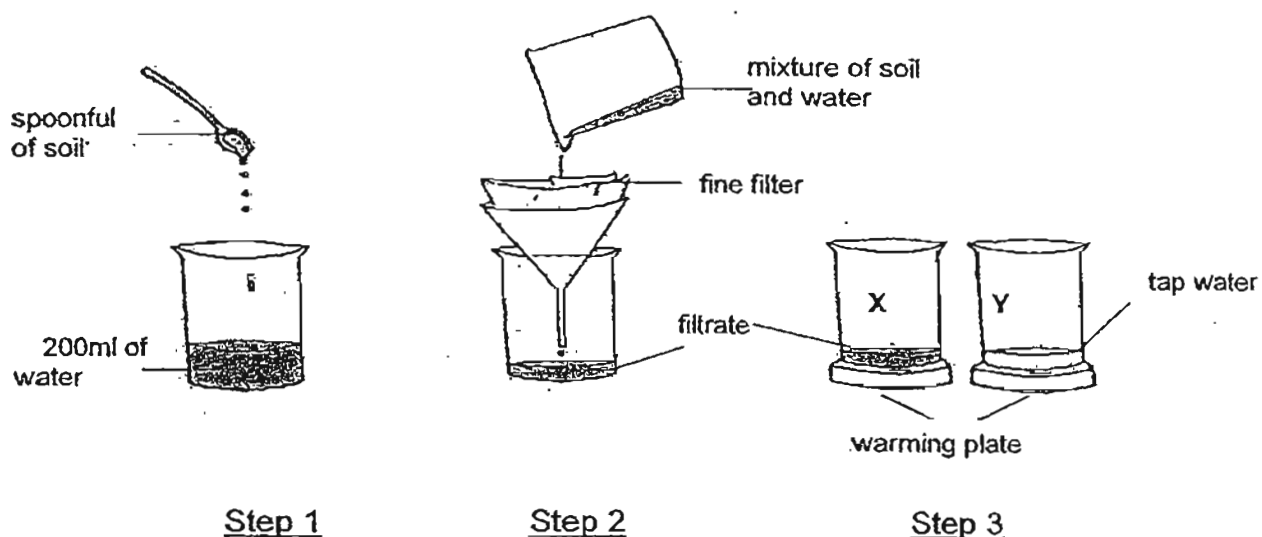

Step 1: She mixed a spoonful of soil from her garden into a beaker containing 200ml of water from the tap to obtain a mixture.

Step 2: She filtered the mixture through a fine filter to obtain the filtrate.

Step 3: She evaporated the filtrate in beaker X and a similar amount of tap water in beaker Y.

What would Janet observe in beaker X if her hypothesis was correct and the purpose of tap water in Beaker Y?

	Contents in beaker X after evaporation	Purpose of tap water in Beaker Y
(1)	Nothing	To show that there was no particles that were dissolved in tap water
(2)	small particles	To show that there was no particles that were dissolved in tap water
(3)	Nothing	To show that tap water evaporate faster than the filtrate
(4)	small particles	To show that tap water evaporate faster than the filtrate

- 28 Muthi set up the experiment as shown below. He poured some coffee into the funnel but it did not flow into the bottle. However, when he poured some tea into the funnel of another set-up, it could flow into the bottle.

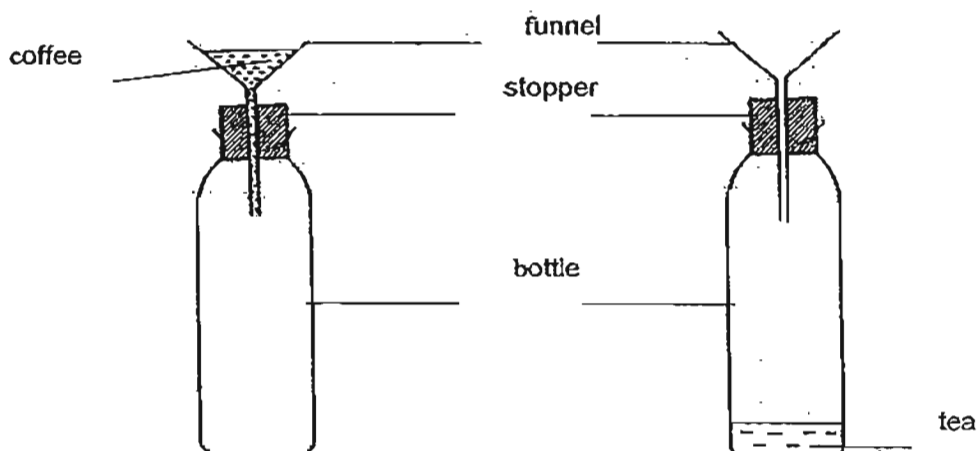

Which one of the following could be the reason for the different results obtained?

- (1) The coffee was cold but the tea was hot.
  - (2) The tea is sugar-free but the coffee is not.
  - (3) The stopper of the bottle containing tea was loose.
  - (4) The tea was poured more quickly than the coffee into the funnel.
- 29 Joe conducted an experiment to find out if water or milk is a better conductor of heat.

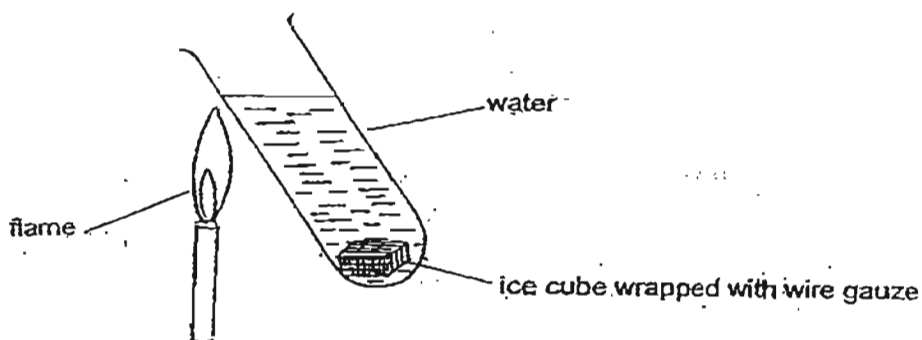

A piece of ice cube was wrapped in wire gauze and placed at the bottom of the test-tube. Next he put a flame at the top of the test-tube filled with water. He then recorded the time taken for the ice cube to melt completely. The experiment was repeated using milk.

Which of the following variables must be kept the same for a fair test?

- A: size of the ice cube
- B: position of the flame applied
- C: amount of liquid in the test tube
- D: time the flame was left on until the ice melted

- (1) A and C only
- (2) B and D only
- (3) A, B and C only
- (4) A, B, C, and D



- 30 Four beakers containing the same amount of water at the same temperature were placed on electric hot metal plates. The hot plates are all the same size but are made of four different metals.

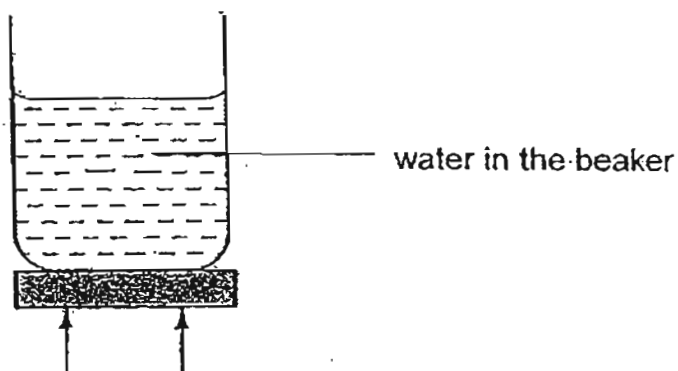

The time taken for the temperature of the water to increase was recorded as shown below. Which plate is made of a metal which is the poorest conductor?

	Plate	Temperature increase	Time
(1)	A	10°C	100s
(2)	B	12°C	100s
(3)	C	15°C	200s
(4)	D	18°C	200s

End of Booklet A



**Rosyth School**  
**First Continual Assessment for 2011**  
**STANDARD SCIENCE**  
**Primary 6**

Name: \_\_\_\_\_

Total  
Marks:

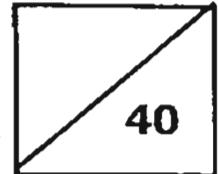

Class: Pr \_\_\_\_\_

Register No. \_\_\_\_\_

Duration: 1 h 45 min

Date: 3<sup>rd</sup> March 2011

Parent's Signature: \_\_\_\_\_

---

## **Booklet B**

Instructions to Pupils:

1. For questions 31 to 44, give your answers in the spaces given in this Booklet B.

\* This booklet consists of 13 pages. (Pg. 1 to 13)

This paper is not to be reproduced in part or whole without the permission of the Principal.

For questions 31 to 44, write your answers in this booklet.

31 The chart below shows how some living things are classified.

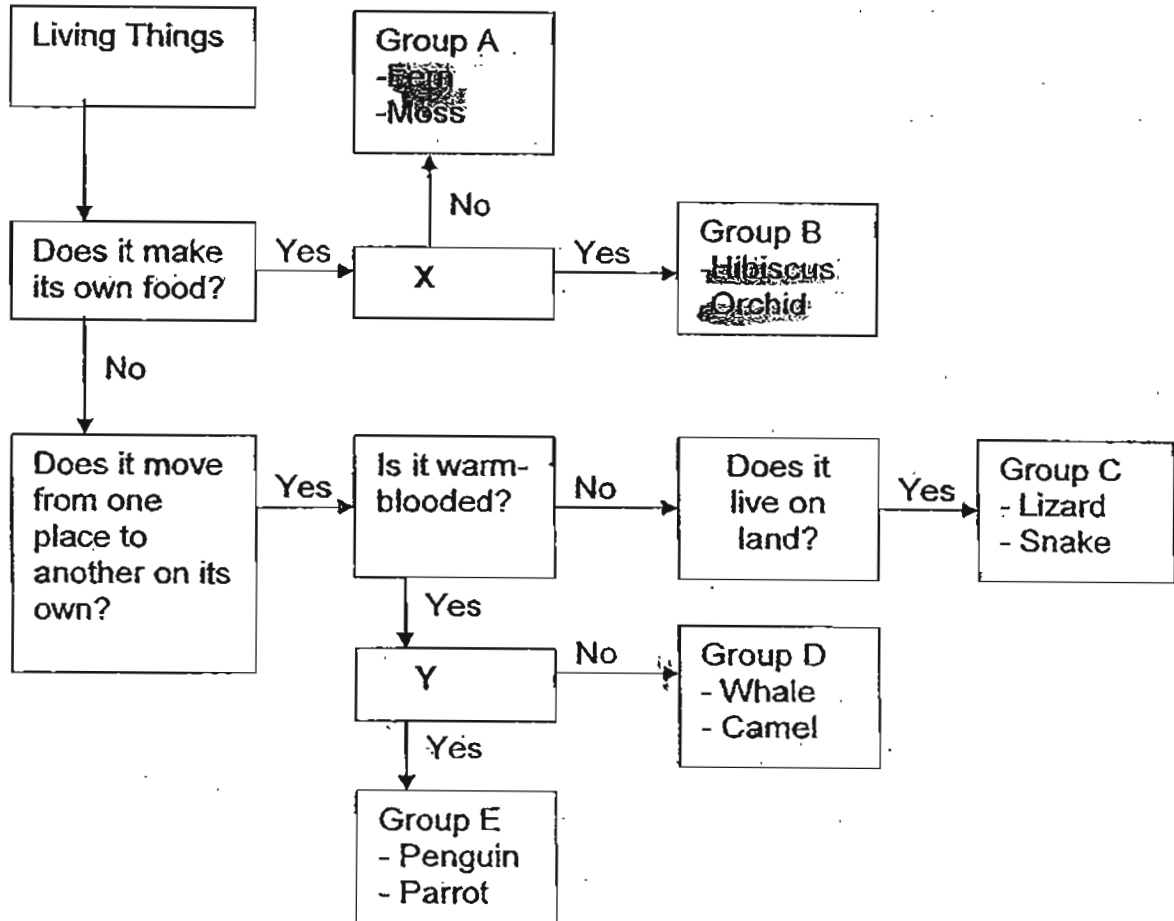

(a) Based on the information above, write a suitable question for each of the following: [2]

(i) X \_\_\_\_\_

(ii) Y \_\_\_\_\_

Question 31 is continued on page 2.

- (b) Study the graph below which shows the body temperature of an animal during different surrounding temperature.

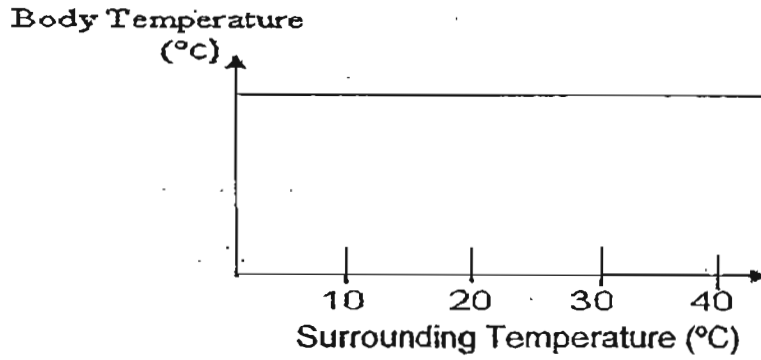

Which group of animals (C or D) would have a body temperature as shown above? Support your choice.

[2]

---

---

---

- 32 Melvin carried out an experiment to observe a germinating seed as shown below.

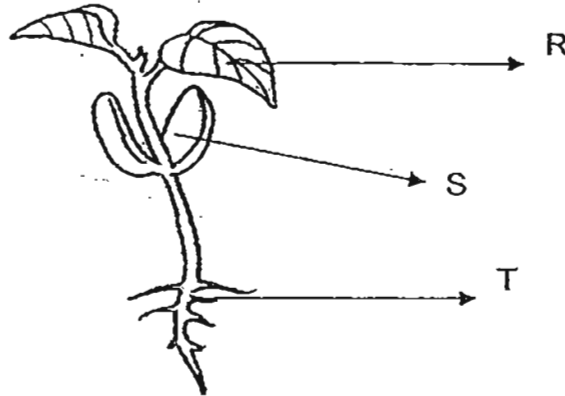

He recorded the mass of the seed leaves and shoot of the seedling in the table below.

Results	Day 0	Day 2	Day 4	Day 6	Day 8	Day 10
X	25g	20g	15g	11g	6g	6g
Y	5g	6g	9g	16g	20g	24g

- (a) Which results, X or Y, shows how the mass of the seed leaves change during the experiment? Give a reason for your answer. [1]

---



---

- (b) Put a tick (✓) in the appropriate box to indicate if it is True, False or Not possible to tell. [2]

	Statements	True	False	Not possible to tell
(i)	It grows downwards to take in nutrients only.			
(ii)	Food is provided by S before R appears.			
(iii)	Based on the table above, the seedling can make its own food after Day 8.			
(iv)	The cells in part S will have chloroplast to make food.			

- 33 Use the double bubble map to state a similarity and a difference between reproductive process in bird and human. [2]

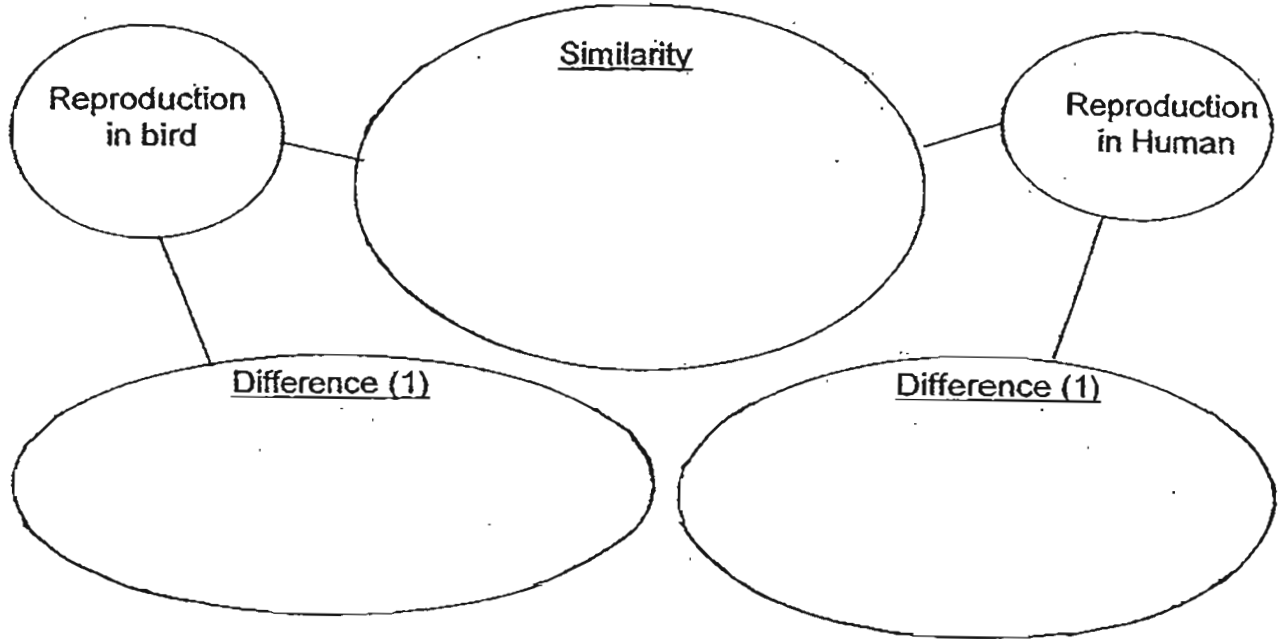

- 34 The diagram below shows a flower.



State the functions of the parts labelled in the table below.

(a)

	Parts	Function
1	A	
2	B	

[2]

- (b) Is the above flower likely to be pollinated by animals or wind? Explain your answer. [1]

---



---

- 35 The diagram below shows flowers containing nectar and two birds, Y and Z with different type of beaks.

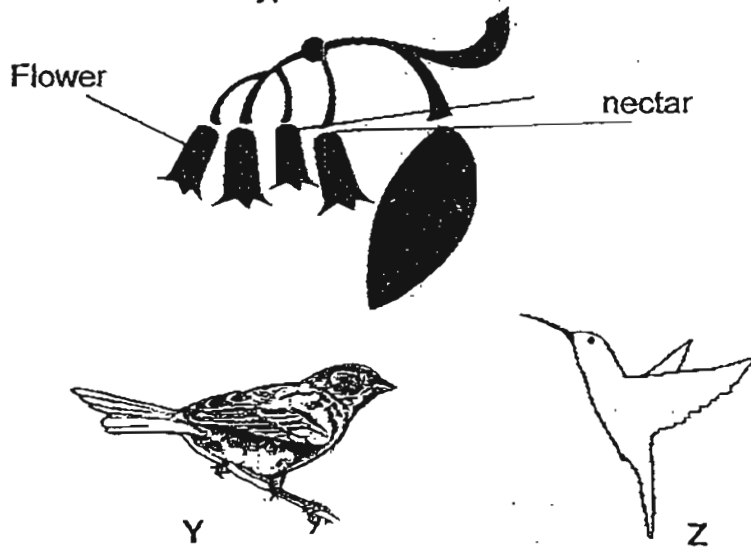

- (a) Which bird, Y or Z, is more likely to feed on the nectar of the above flower? Explain your choice. [1]

---

---

- (b) Explain how the bird you have chosen in (a) is important to the flower? [1]

---

---

- (c) Describe what would happen when pollen grains lands on the stigma. [2]

---

---

---

36. A group of pupils saw a plot of land with some plants growing as shown below.

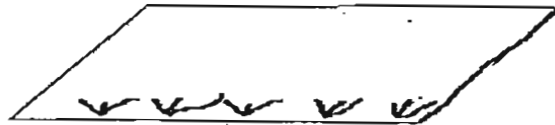

After a short time, the group of pupils saw the plot of land covered with the same type of plants.

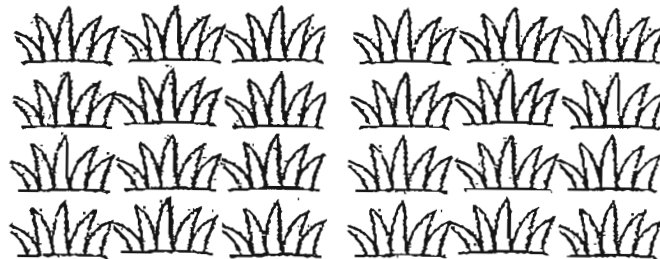

Through research, the pupils found that the plant can reproduce in two ways as shown below.

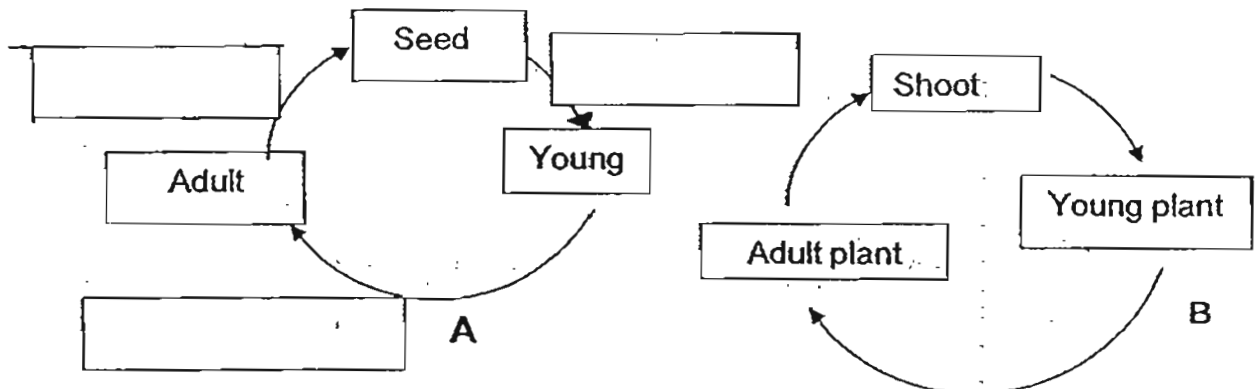

- (a) Label the process 'Pollination' in the correct box for A: [1]
- (b) Which type of reproduction (A or B), has the plant mainly carried out in the above situation? Explain your choice. [2]

---



---



---



37 The diagram below shows the human digestive system.

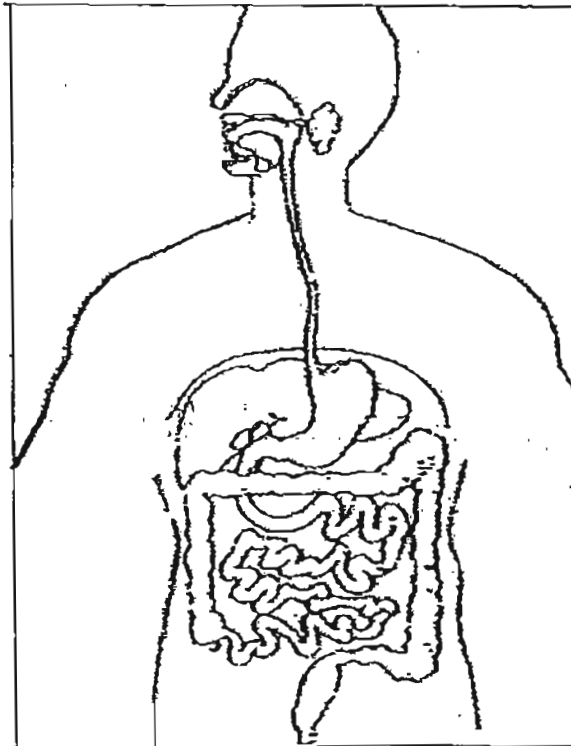

- (a) Draw a line and label the part of the system where water is absorbed into the body again. [1]
- (b) Describe how our digestive system and circulatory system work together to supply digested food to our body parts. [2]

---

---

---

---

- 38 Henry was given a cell from a multicellular organism to observe under the microscope. His teacher told him that a part of the cell has been removed.

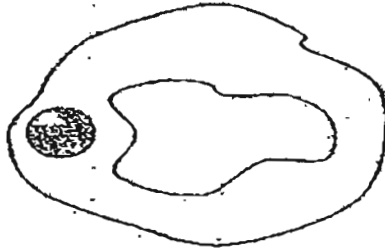

- (a) Which group of living things was the cell taken from? Give a reason for your answer. [1]

---

---

- (b) Name the part of the cell that has been removed. [1]

---

- 39 The diagram shows a solar still which is used to treat water and make it drinkable.

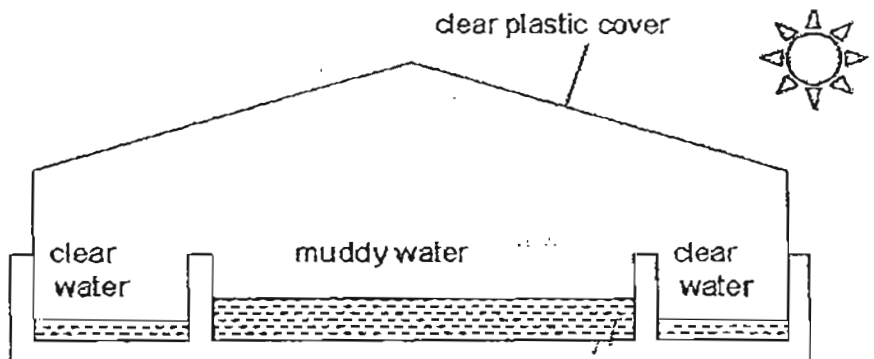

- Explain how clean water is obtained from muddy water. [2]

---

---

---

---

- 40 Zhanli used two identical beakers and poured 200 ml of water into each beaker. He set up the experiment below at the same place to find out how the exposed surface area of the water affect the rate of evaporation.

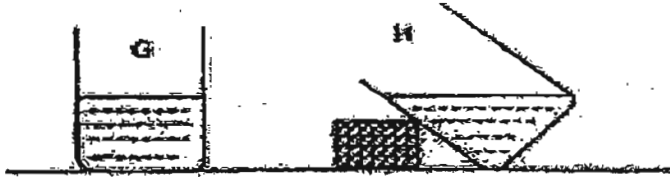

- (a) Explain why the experiment is not a fair test. [1]

---

---

---

- (b) What set-up could Zhanli use to ensure a fair test? One beaker has been drawn in the box below. Draw another container he could use. [1]

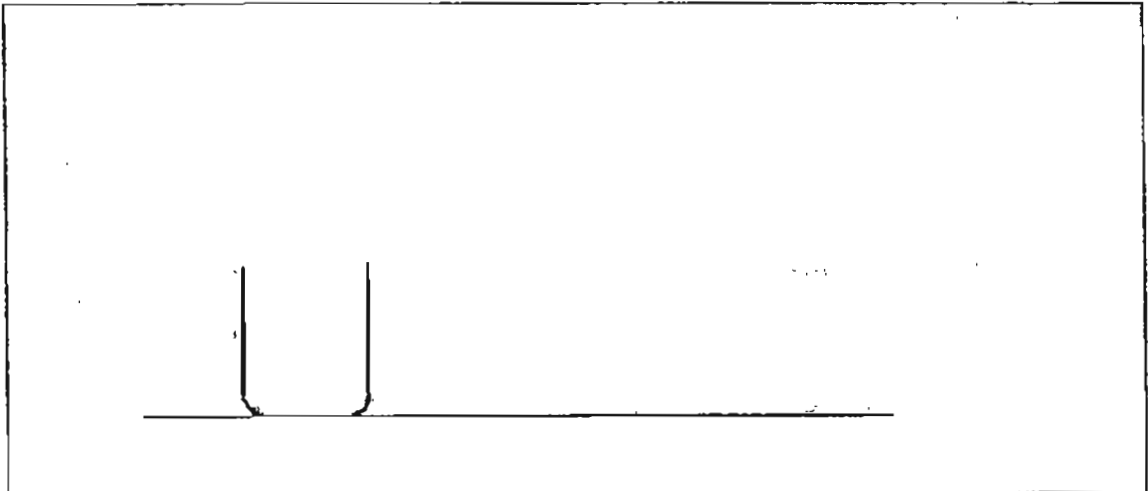

- (c) What could he do to shorten the time of the experiment and get the results sooner? [1]

---

---

- 41 An experiment for making rain was set up as shown below.

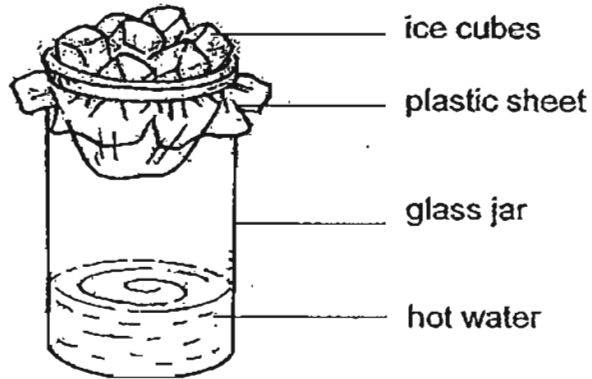

Ginny used the apparatus to carry out an experiment to find out if the temperature of hot water would affect the rate of condensation.

- (a) What was the variable changed? [1]

---

- (b) What was the variable measured? [1]

---

- (c) What has to lose heat in order for the process of condensation to take place? [1]

---

- 42 Some pure water in a beaker was left on a table in a room over a period of time. The temperature of pure water initially was  $40^{\circ}\text{C}$ . The temperature of water stopped decreasing after the third minute and remains at  $30^{\circ}\text{C}$ . A heat source was introduced at the 6th minute. The water boiled after heating for four minutes. The heat source was removed at the 12th minute.

Label the x-axis and complete the graph until the 12th minute. [4]

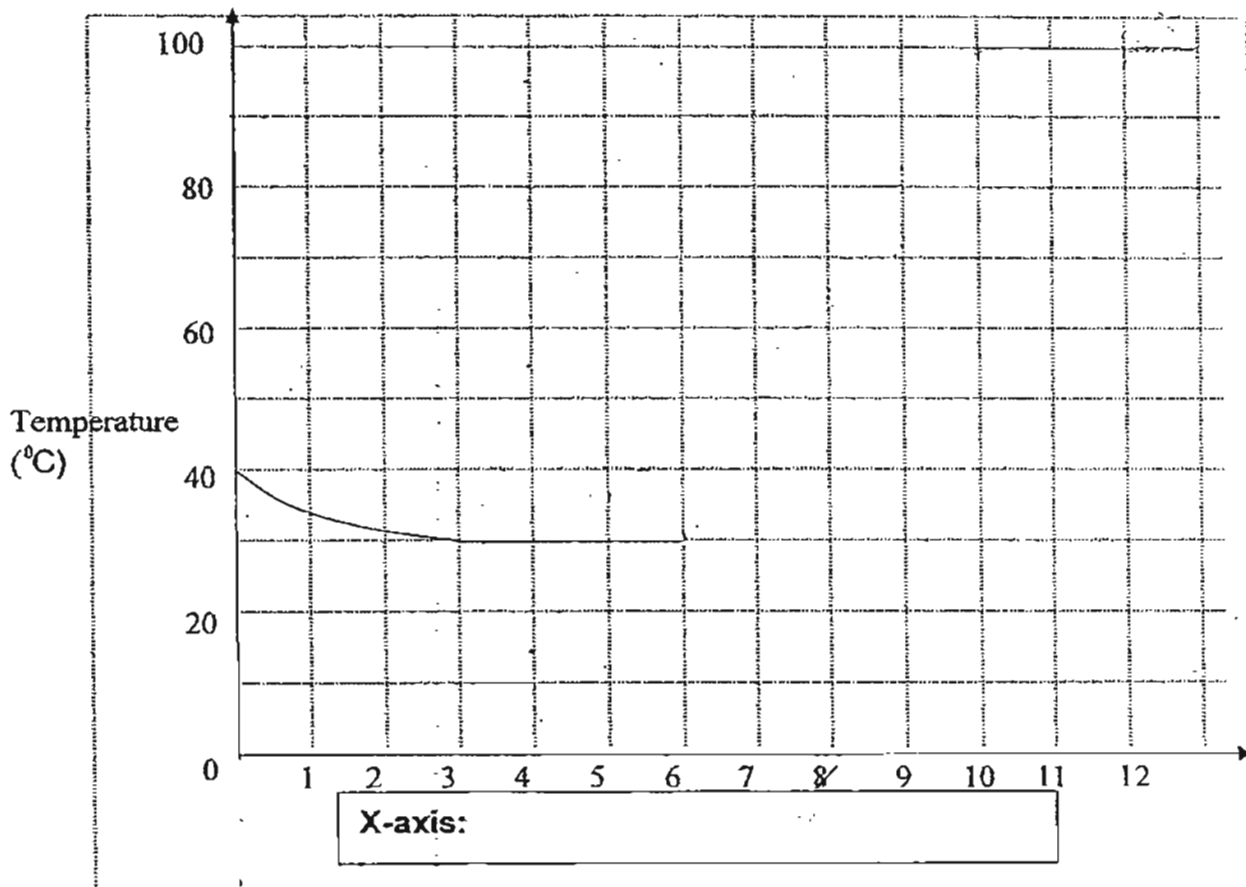

- 43 Marjorie placed a syringe between two pieces of wood. The syringe contained some water and air trapped in it. Weights were placed on the top piece of wood as shown in the diagram below.

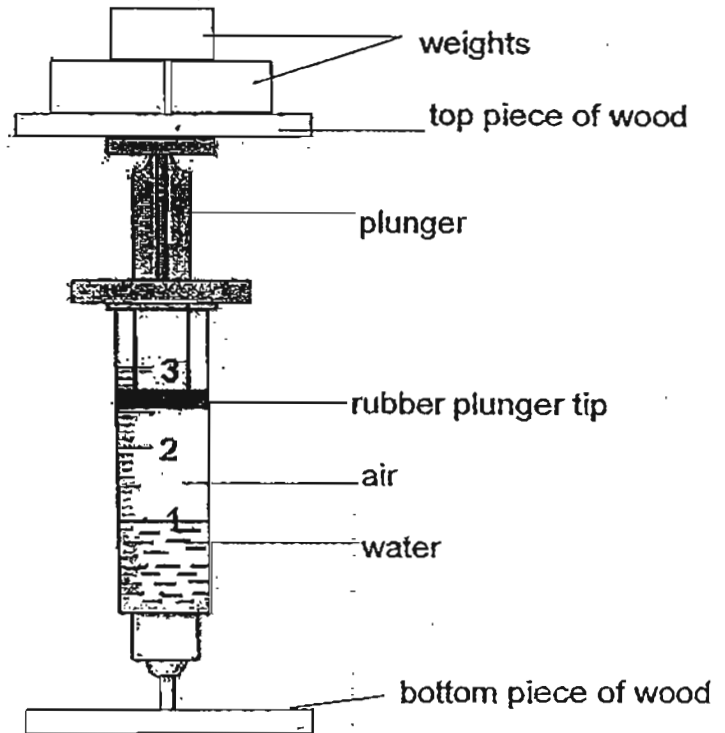

- (a) What happened to the volume of air and water in the syringe respectively when the weights were placed on the syringe? [1]

---

---

---

---

- (b) As increasing weights were added, would the rubber plunger tip reach the mark '1' which indicate the water level? Explain your answer. [1]

---

---

---

- 44 Ahmad has four cups which are made of different materials (A, B, C and D). The cups are of the same size and thickness. Ahmad then filled each cup with 250 ml of hot coffee. The temperature of the coffee was  $60^{\circ}\text{C}$ . All four cups were left on the dining table to cool and their temperatures were measured every 2 minutes.

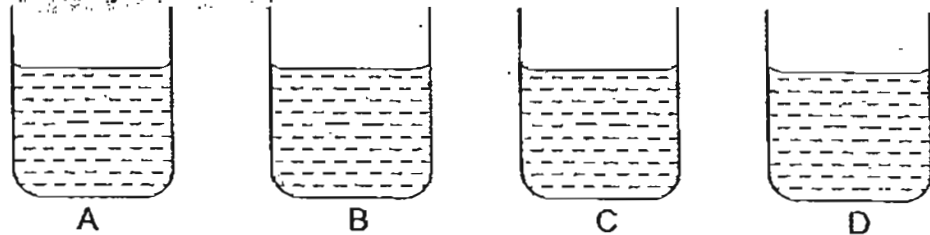

The results of the experiment are plotted on the graph below.

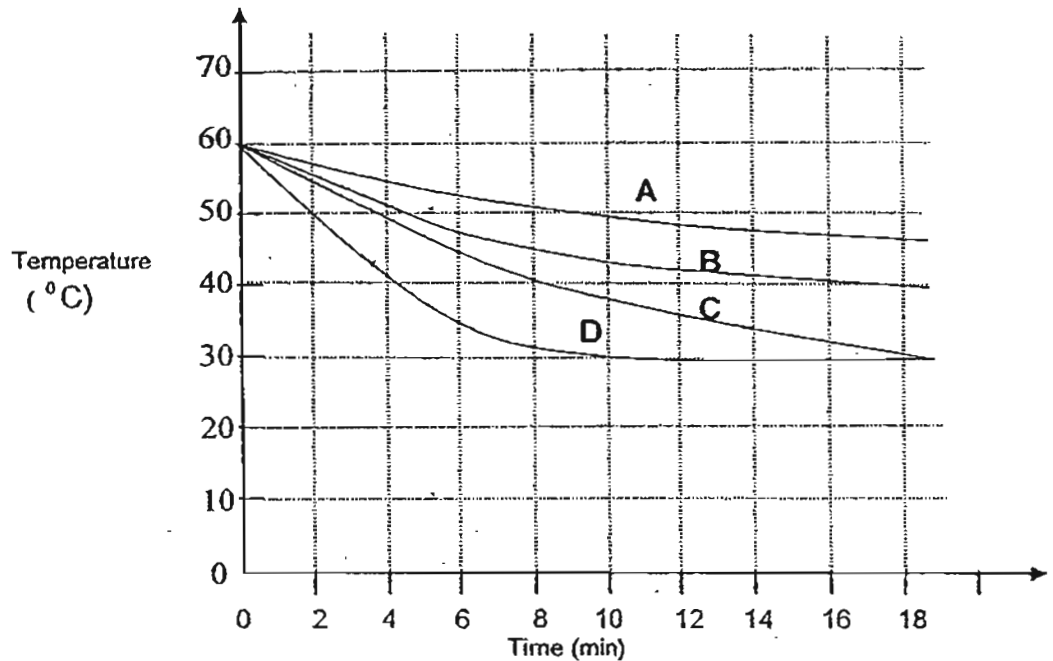

- (a) Which cup of coffee took the shortest time to cool to room temperature? State the time taken: [1]

- (b) Which cup (A, B, C or D) must Ahmad use to contain ice-cream if he does not want the ice-cream to melt quickly? Explain your answer. [1]

End of Paper







# ANSWER SHEET

**EXAM PAPER 2011**

**SCHOOL : ROSYTH PRIMARY  
SUBJECT : PRIMARY 6 SCIENCE**

**TERM : CA1**



Q1	Q2	Q3	Q4	Q5	Q6	Q7	Q8	Q9	Q10	Q11	Q12	Q13	Q14	Q15	Q16	Q17
4	2	4	1	4	4	1	3	2	4	2	2	4	3	3	4	2

Q18	Q19	Q20	Q21	Q22	Q23	Q24	Q25	Q26	Q27	Q28	Q29	Q30
2	4	3	1	1	1	4	2	2	2	3	3	3

31)a)i)It is a flowering plant?      ii)Does it lay eggs?

b)Group D. It is warm-blooded animal and has a constant temperature.

32)a)Results X. As the seedling grows, it takes in more food provided by the seed leaves, so the mass of the seed leaves will decrease.

b)i)F    ii)T    iii)T    iv)F

33)Similarity: Both require the fusion of a sperm and an egg.

Difference 1: Young develops in an egg.

Difference 1: Young develops in female's body.

34)a)A: Produces pollen grains and stores them in pollen sacs.

B: Receives pollen grains.

b)The flower is likely to be pollinated by wind. The anthers hang out of the flower for the pollen grains to be carried by the wind and the stigma is large and feathery to trap pollen grains carried by the wind.

35)a)Its beak is longer than Y and can reach inside the flower where the nectar is.

b)As bird Z feeds on the nectar, some pollen Grains will stick to its feathers, and the pollen grains will be carried away for pollination.

c)The pollen grain will grow a pollen tube which travels down the style to reach the ovary, where it fertilizes the egg cells in the ovules.

36)a)Pollination.

b)B. They do not need to disperse their seeds, and they grow near to the parent plant.

37)a)

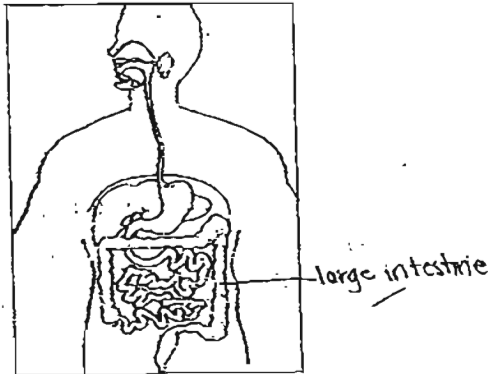

b) The digestive system breaks down food into simpler substances and the digested food is absorbed into the bloodstream.

38)a) The cell was taken from a plant. There is a vacuole, which only plant cells have.

b) The cell wall.

39) The muddy water evaporates due to the heat from the sun to form water vapour, leaving the mud behind and condenses into tiny water droplets when it comes into contact with the cooler inner surface of the clear plastic cover, and falls back at the corners of the solar still as pure water.

40)a) Beaker G has a constant rate of evaporation as its exposed surface area did not change. However, beaker H's exposed surface area increased.

b)



c) Put the set-ups under the sun/in the presence of wind.

41)a) The temperature of hot water.

b) The rate of condensation.

c) The hot water vapour which evaporates from the hot water.

42)

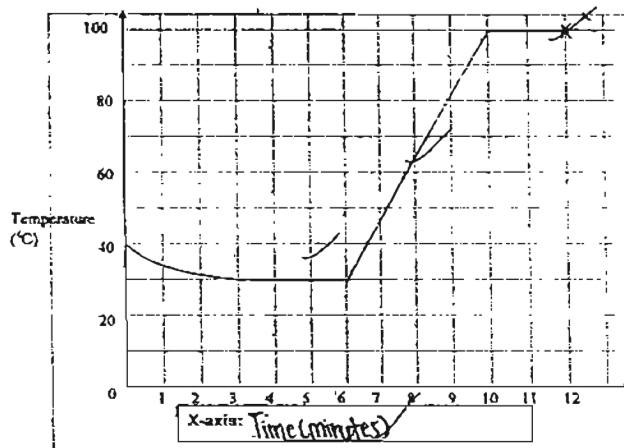

**43)a)The volume of air decreased as it was compressed while the volume of water remained the same as it could not be compressed.**

**b)No. it will not reach the mark '1'. Although the air in the syringe can be compressed, it cannot be totally compressed as it occupies space, so the rubber plunger tip cannot reach the mark '1'.**

**44)a)Cup D. 10 minutes.**

**b)He must use cup A. Since the temperature of the hot coffee was the highest at the end of the experiment, material A is the poorest conductor of heat and therefore will not conduct heat to the ice-cream so quickly, causing the ice-cream to stay cold and not melt.**