

SA1

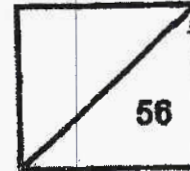

Rosyth School
Mid-Year Examination 2021
SCIENCE
Primary 6

Total
Marks:



Name: _____

Class: Pr 6- _____ Register No. _____

Total time for
Booklets A and B: 1 h 45 min

Date: 7 May 2021

Booklet A

Instructions to Pupils:

1. Do not open the booklet until you are told to do so.
2. Follow all instructions carefully.
3. This paper consists of 2 booklets, Booklet A and Booklet B.
4. For questions 1 to 28 in Booklet A, shade the correct ovals on the Optical Answer Sheet (OAS) provided using a 2B pencil.

* This booklet consists of 18 printed pages (including cover page).

This paper is not to be reproduced in part or whole without the permission of the Principal.



For each question from 1 to 28, four options are given. One of them is the correct answer. Make your choice (1, 2, 3 or 4). **Shade the correct oval (1, 2, 3 or 4) on the Optical Answer Sheet.** (56 Marks)

1 Study the table below.

Key √: present

Function	Parts of the human digestive system			
	P	Q	R	S
Digestion takes place	√			√
Digestion is completed				√
Removes water from food		√		

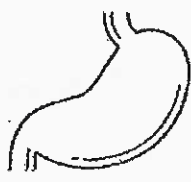
Which one of the following correctly matches the functions to the three parts of the human digestive system as shown below?

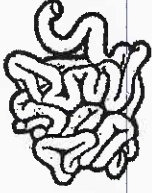
			
(1)	P	R	S
(2)	P	Q	S
(3)	P	Q	R
(4)	S	Q	P

2 The diagram below shows the gills and the nostril of a fish.

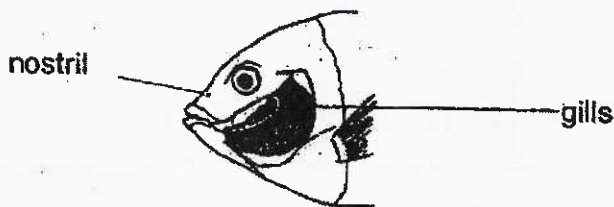

Which of the following about the gills of a fish is true?

- (1) Gills and nostril carry out similar functions.
- (2) Gills are part of the circulatory system of a fish.
- (3) Gills are part of the respiratory system of a fish.
- (4) Gills take in carbon dioxide and give out oxygen.

- 3 The diagram below shows how blood flows in certain parts of the human body. W, X, Y and Z represent the blood vessels at different parts of the human body.

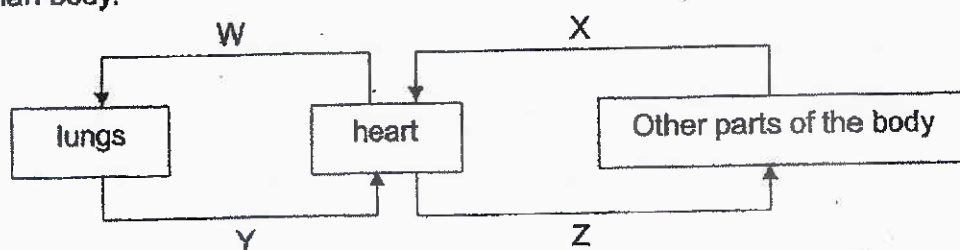

Which graph shows the correct amount of oxygen in each blood sample?

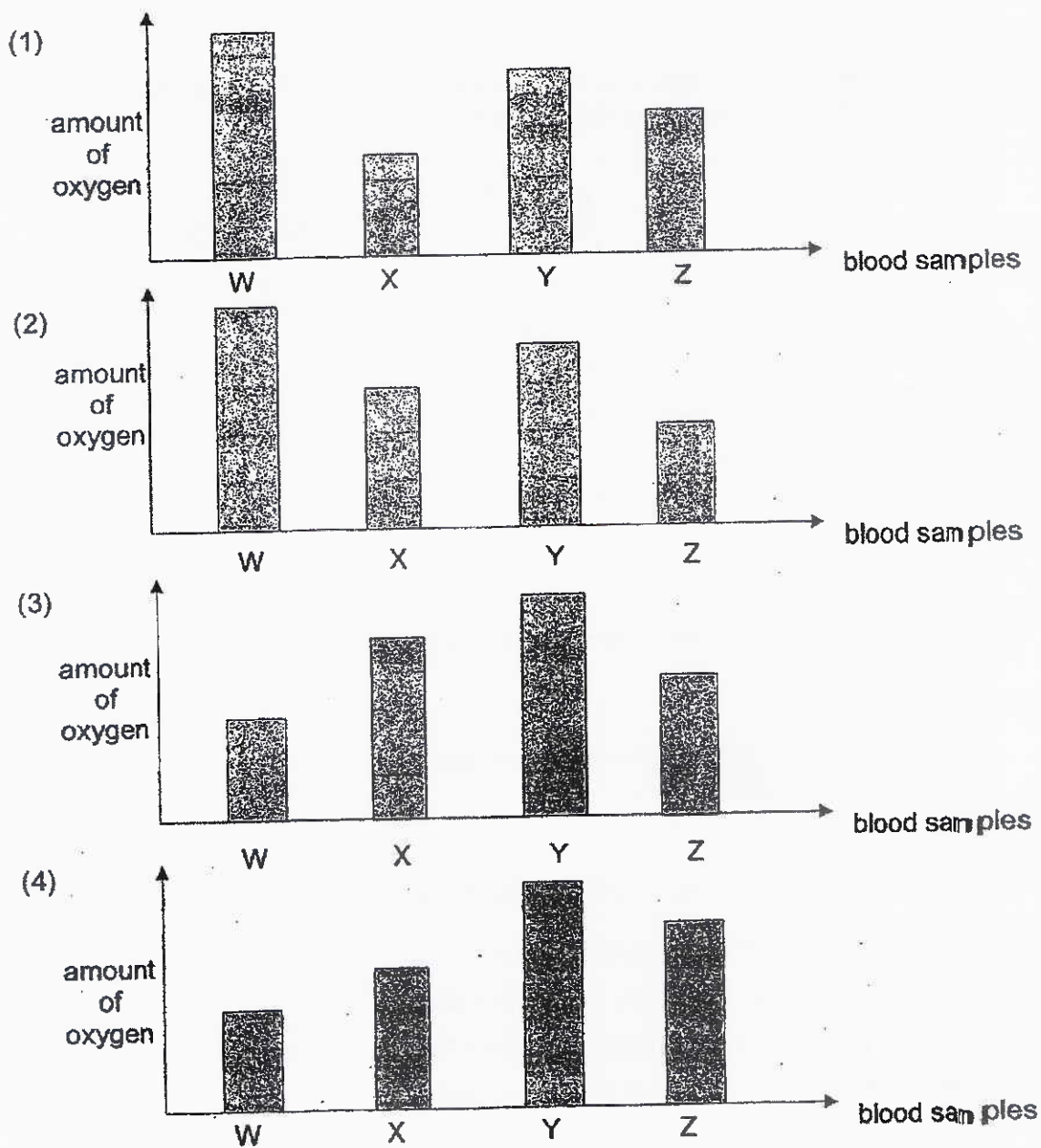

- 4 The graph shows the volume of air in the lungs of a person at rest, over a period of 8 seconds.

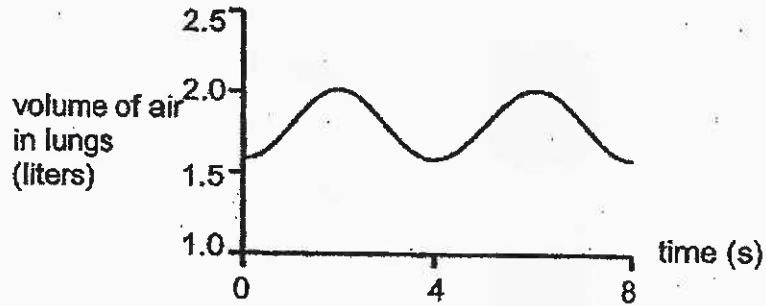

Which graph shows the volume of air in the lungs of the same person immediately after exercise over a period of 8 seconds?

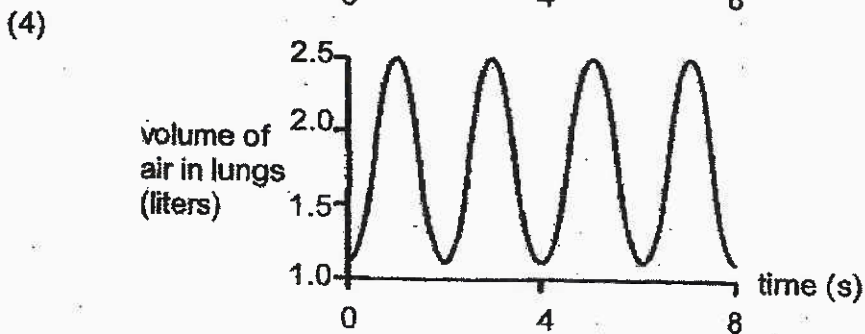
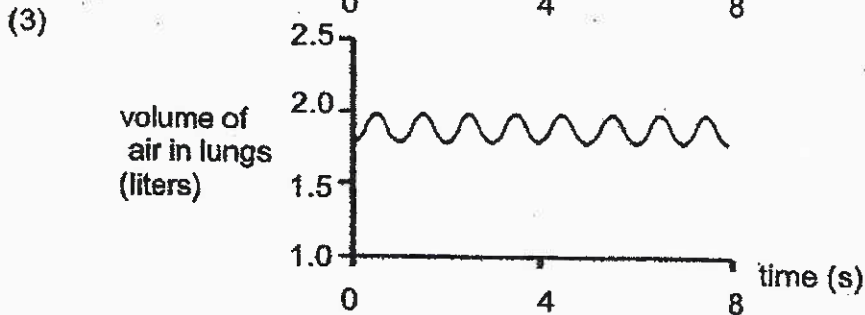
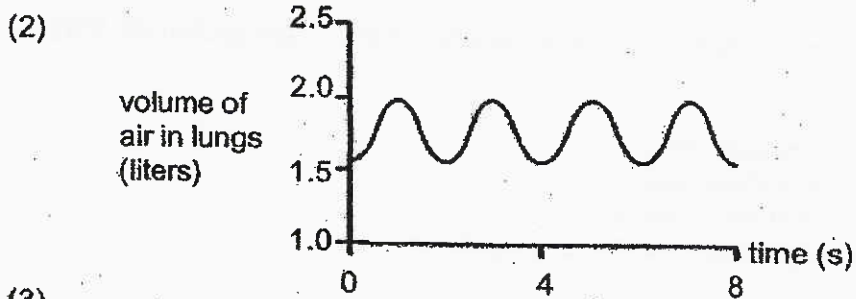
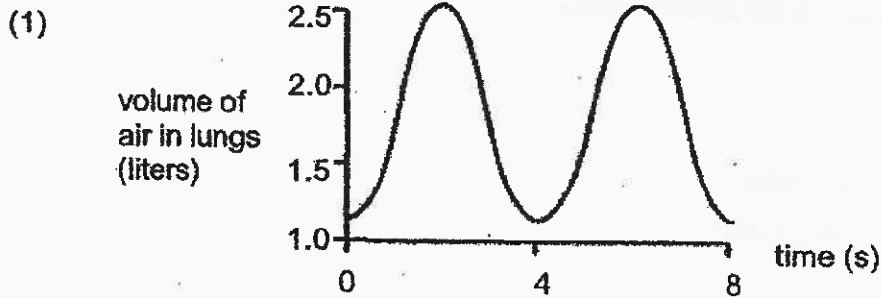

- 5 The diagram below shows the stem of a tree with its outer ring removed at Z. After some time, the stem was swollen at point P.

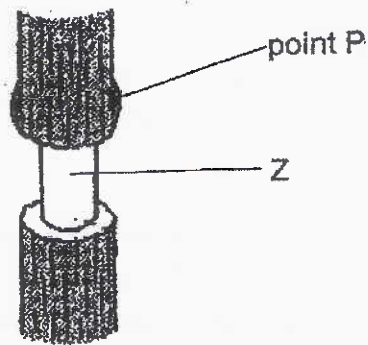

What is transported to the part labelled Z?

- (1) food only
 (2) water and food
 (3) food and mineral salts
 (4) water and mineral salts
- 6 Both human circulatory system and plant transport system are similar as they transport _____.
- A water and mineral salts
 B oxygen and carbon dioxide
 C substances in one direction
 D substances through the blood vessels
- (1) A only
 (2) A and D only
 (3) B and C only
 (4) A, B and D only

7 Which diagram below correctly shows the movement of water in plants?

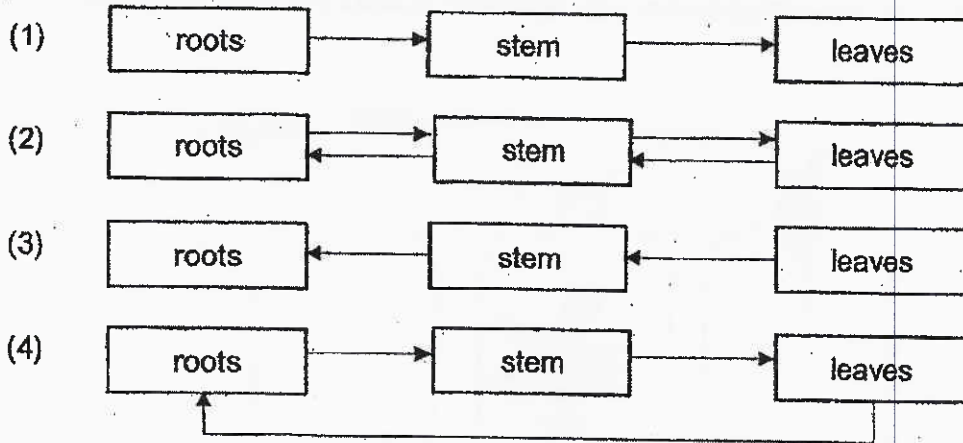

8 The diagram shows a leaf cell. Which part carries out photosynthesis?

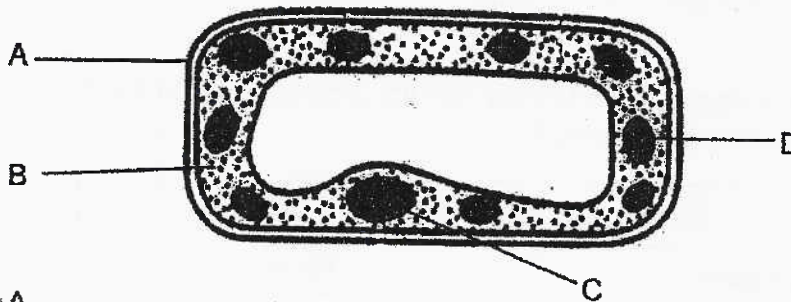

- (1) A
- (2) B
- (3) C
- (4) D

- 9 In an experiment, three transparent jars, Q, R and S, were set up as shown in the diagram.

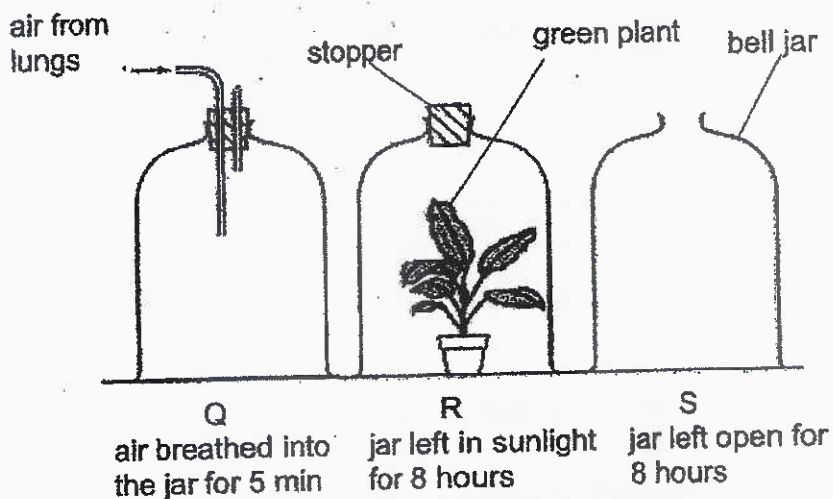

At the end of the experiment, which bell jar has the greatest and the least amount of carbon dioxide respectively?

Volume of carbon dioxide		
	greatest	least
(1)	Q	R
(2)	S	R
(3)	Q	S
(4)	R	S

- 10 The same type of organisms living and reproducing in a particular place is called a/an _____.

- (1) habitat
- (2) organism
- (3) population
- (4) community

- 11 The diagram shows a food chain.



If all the snakes are killed, what will be the effect on the number of the other organisms in the food chain?

	Leaves	Caterpillars	Frogs
(1)	increase	increase	decrease
(2)	decrease	decrease	increase
(3)	decrease	increase	decrease
(4)	increase	decrease	increase

- 12 Study the incomplete food chain.

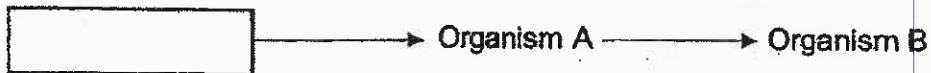

Which one of the following is needed to complete the above food chain?

- (1) Sun
- (2) Prey
- (3) Producer
- (4) Consumer

13

Randy wrote a hypothesis: "The poles of an electromagnet is reversed when the positive terminal (+) and negative terminal (-) of the battery is connected in an opposite way."

The diagrams below, A, B, C and D, show how the electromagnet is connected and how a bar magnet or iron bar moves when it is brought near an electromagnet.

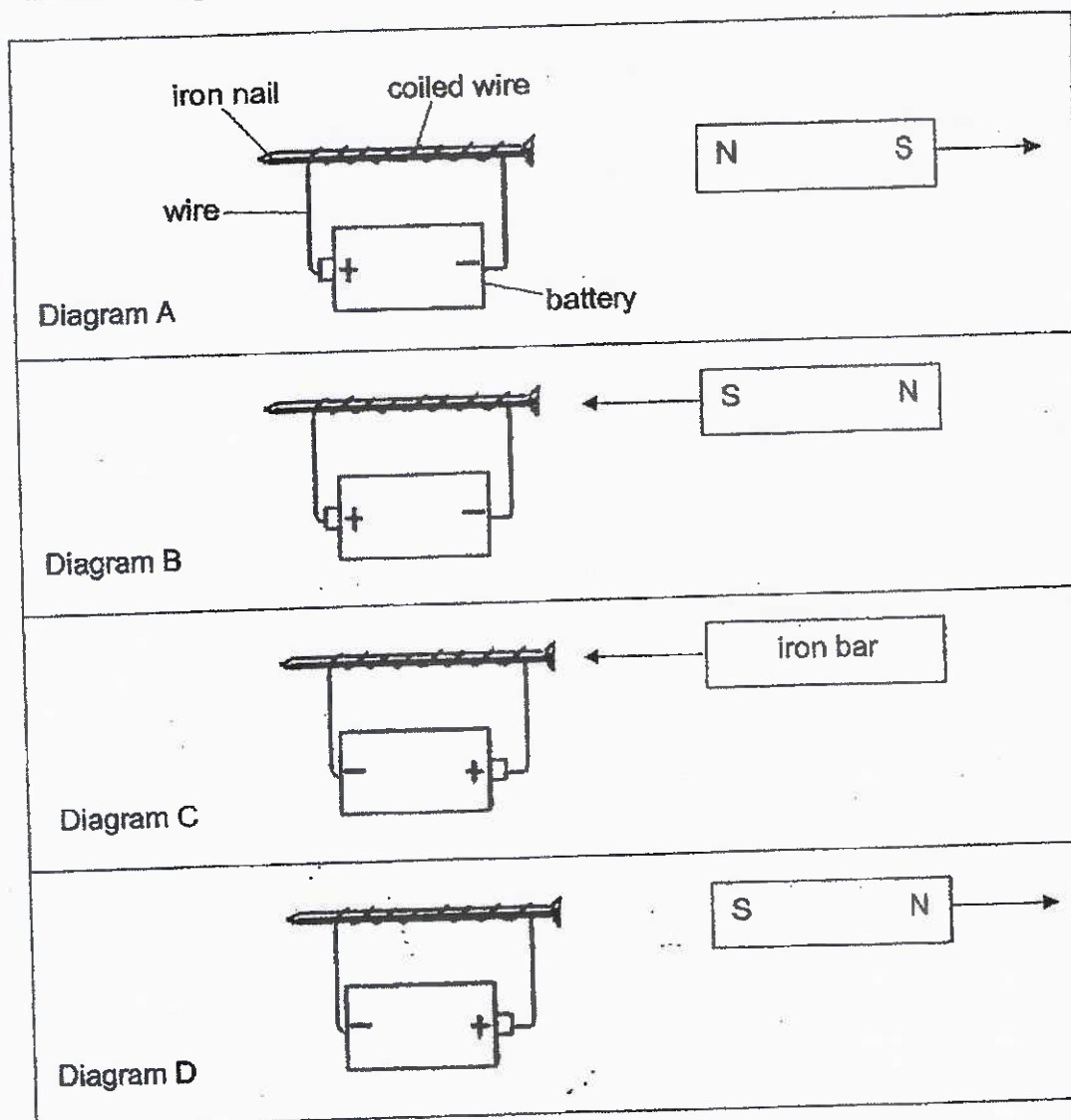

Which diagrams supports his hypothesis?

- (1) A and B
- (2) A and C
- (3) B and C
- (4) B and D

14 Ali had four wooden frames, P, Q, R and S, as shown below.

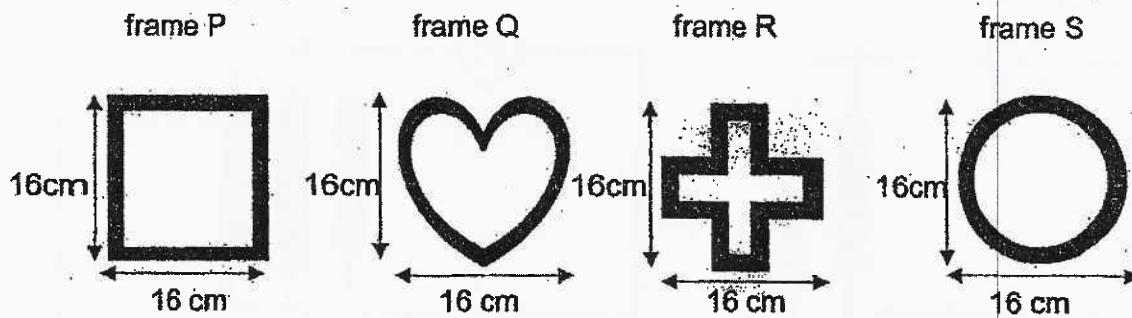

He hung the wooden frames between a lamp and a screen. The shadows formed on the screen are as shown.

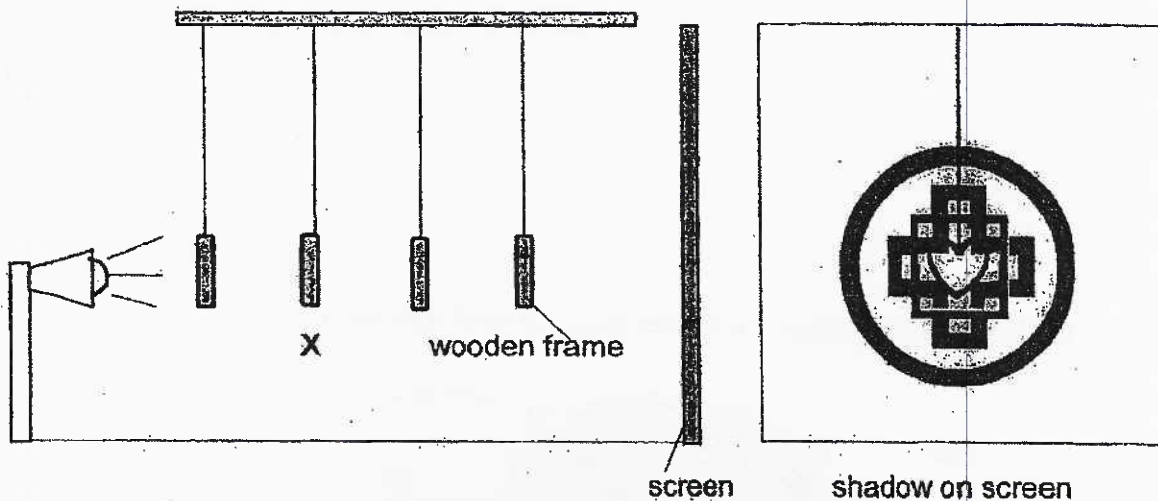

Which wooden frame was hung at position X?

- (1) P
- (2) Q
- (3) R
- (4) S

- 15 A copper rod, glass rod and wooden rod are used in each of the two circuits, P and Q as shown below.

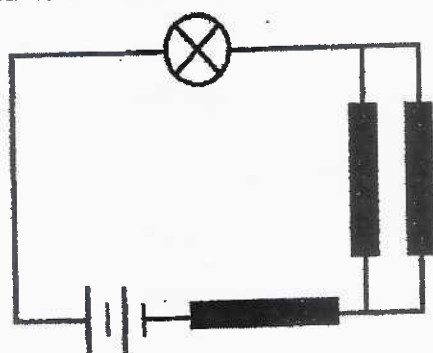

circuit P

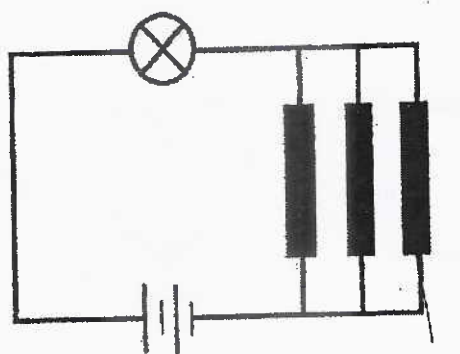

circuit Q

rod

Which of the above circuit(s) would the bulb light up?

- (1) P only
 - (2) Q only
 - (3) Both P and Q
 - (4) None of the circuits
- 16 Animal J lives in a hot condition and it likes to cover itself with mud.

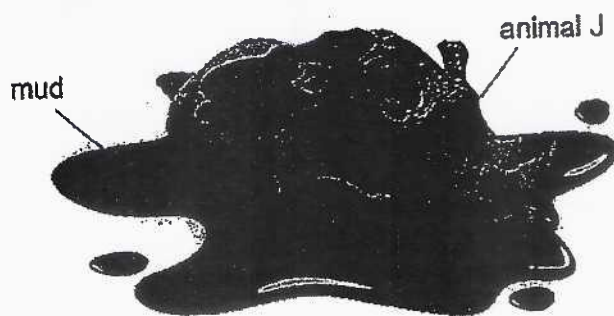

Which of the following explains how the mud helps animal J?

- (1) It reduces heat lost to the air.
- (2) It loses heat to animal J faster.
- (3) It loses heat to the surrounding air slower.
- (4) The water in the mud gains heat from animal J.

- 17 Study the diagram which shows how water exists at different temperatures, E, F and G, as ice is heated over a period of time.

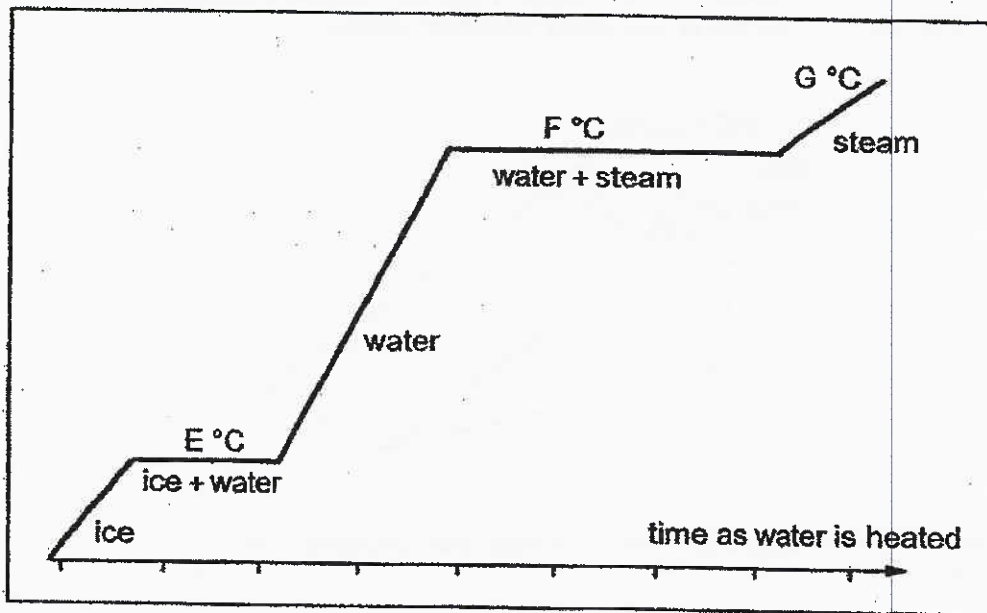

Which of the following shows the temperature for E, F and G in the diagram above?

	E °C	F °C	G °C
(1)	0	90	100
(2)	0	100	120
(3)	0	100	100
(4)	10	100	120

- 18 Johnson listed some sources of energy and their forms of energy. Which one of the following is not correct?

	Source of energy	Form of energy
(1)	Wind	Kinetic
(2)	Sun	Heat and Light
(3)	Food	Potential
(4)	Battery	Electrical

- 19 Ravinder had two identical solid cylinders. He drilled a hole through one of the cylinders and made it hollow in the middle. Then he released both cylinders, hollow and solid, from the top of the ramp as shown below.

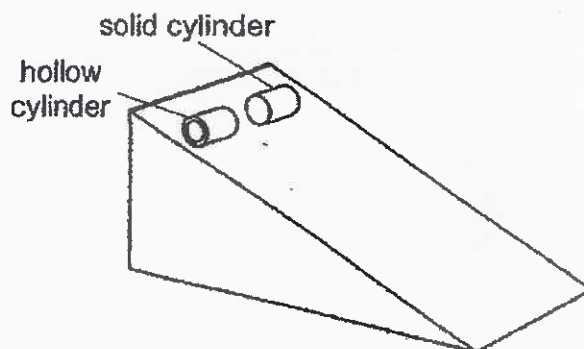

Which one of the following is the same for both the cylinders in the experiment?

- (1) Gravitational force acting on both cylinders.
 - (2) Potential energy possessed by the cylinders at the top of the ramp.
 - (3) Friction between the surface of the cylinders and the surface of the ramp.
 - (4) Kinetic energy possessed by the cylinders when the cylinders are resting on the ground.
- 20 Study the energy conversion below.

Potential Energy → Kinetic Energy → Electrical Energy

Which one of the following can represent the energy conversion correctly?

- (1) Using a handphone
- (2) Switching on a television
- (3) Spinning a bicycle dynamo
- (4) Typing on a computer keyboard

21 A ball is thrown as shown below.

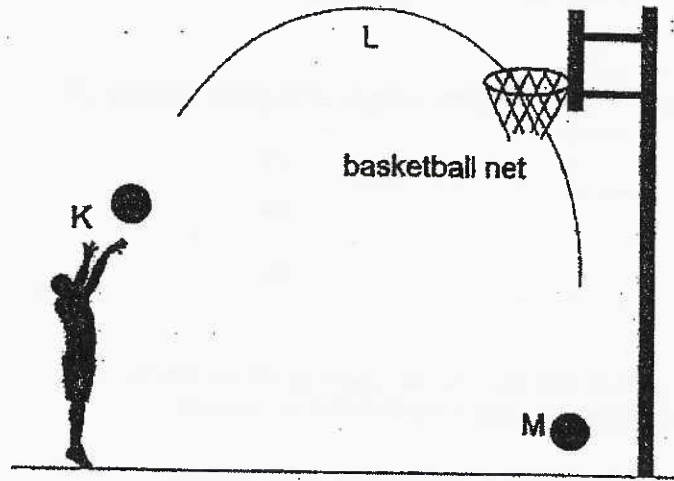

Which graph shows the kinetic energy of the ball at points K, L and M?

(1)
Kinetic energy
(units)

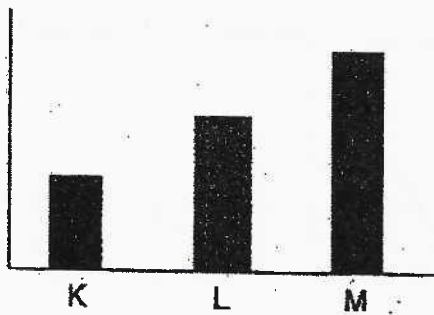

(2)
Kinetic energy
(units)

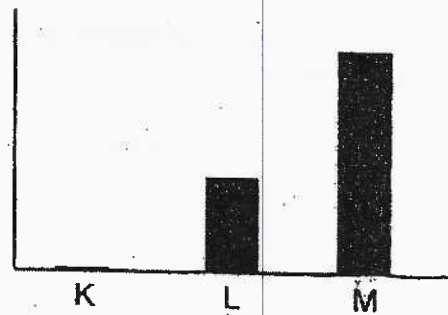

(3)
Kinetic energy
(units)

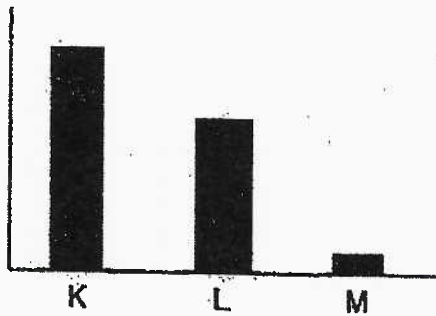

(4)
Kinetic energy
(units)



- 22 The table shows the percentage of useful energy released from three types of batteries, R, S, and T. Each battery is charged to 100 units.

Battery	Percentage of useful energy (%)
R	70
S	85
T	90

The batteries are used in similar electric cars to move them. Using the information above, which statement is correct?

- (1) Battery T generates the most amount of heat energy.
 - (2) Battery T will take the longest time to charge to 100 units.
 - (3) Battery R converts the potential energy to least electrical energy.
 - (4) Battery S will allow the electric car to travel more distance than Battery T.
- 23 Stacie throws a ball downwards to hit on the net. Then the ball bounces up after it has hit the net.

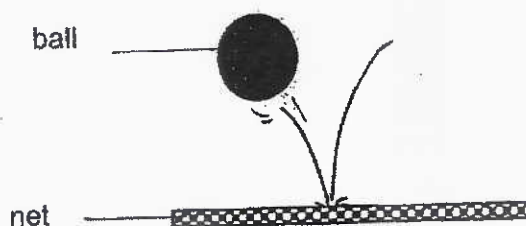

What force causes the ball to bounce up after it has hit the net?

- (1) pulling force from the net
- (2) pulling force from the ball
- (3) pushing force from the net
- (4) pushing force from the ball

24 Which of the following is not an effect of force?

- (1) Change in state
- (2) Change in shape
- (3) Change in speed
- (4) Change in direction

25 A toy car is stationary on a slope as shown below.

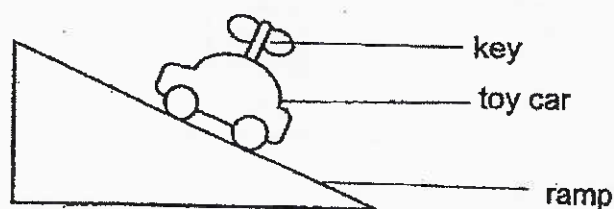

What force/s is/are acting on the toy car when it is stationary on the slope?

- (1) Frictional force only
- (2) Gravitational force only
- (3) Frictional force and gravitational force only
- (4) Frictional force, gravitational force and elastic spring force

- 26 Two objects, D and E of 2kg each, are hung on two springs, X and Y, as shown below.

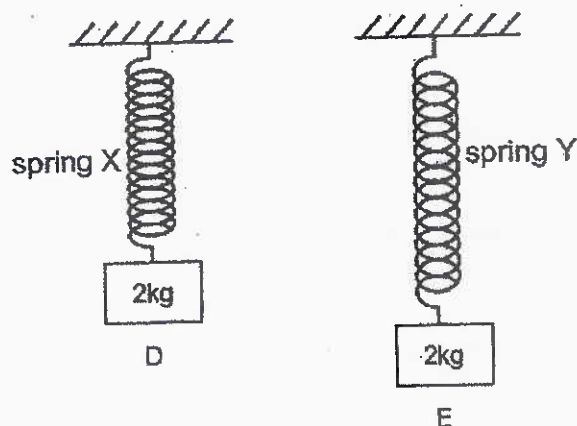

Which of the statements is true?

- (1) There is more gravitational force acting on object E than object D.
 - (2) There is more elastic spring force acting on object D than object E.
 - (3) Spring Y will not return to its original length when object E is removed.
 - (4) More force is needed to extend spring X to the same length as spring Y.
- 27 Weights are added to two springs of the same material. The length of the springs, as weights are added, are shown in the graph.

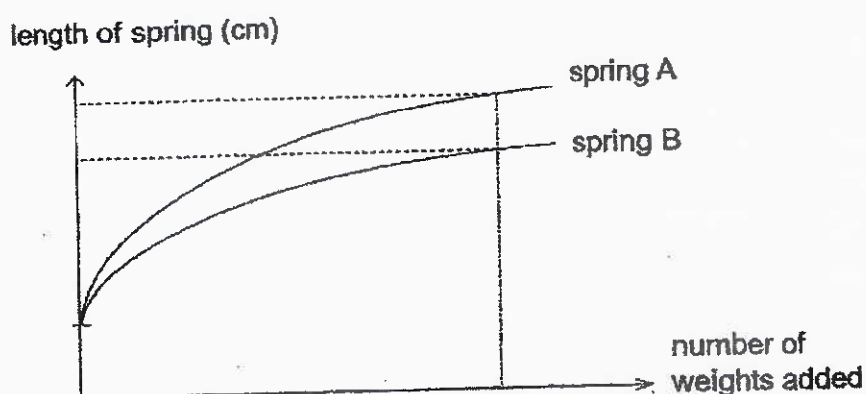

Based on the graph, what cannot be concluded about spring A and B?

- (1) Spring A is stiffer than spring B.
- (2) Spring A is less stiff than spring B.
- (3) Spring A is less elastic than spring B.
- (4) Spring A is more elastic than spring B.

- 28 Miriam set up an experiment using two identical bar magnets, G and H. Magnet G is hanging on a spring balance and magnet H is placed on a weighing scale. The readings on both spring balance and weighing scale is shown in the table below.

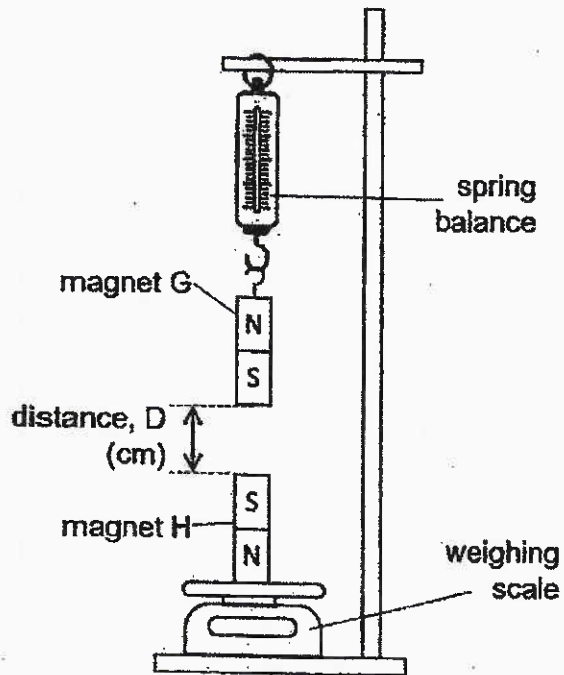

Reading on spring balance (N)	Reading on weighing scale (N)
25	40

Miriam moved the spring balance downwards, which reduced the distance, D. Which of the following shows the likely readings on the spring balance and weighing scale?

(1)

Reading on spring balance (N)	Reading on weighing scale (N)
25	40

(2)

Reading on spring balance (N)	Reading on weighing scale (N)
20	30

(3)

Reading on spring balance (N)	Reading on weighing scale (N)
30	45

(4)

Reading on spring balance (N)	Reading on weighing scale (N)
20	45

Go to Booklet B



Rosyth School
Mid-Year Examination 2021
SCIENCE
Primary 6



Name: _____

Total
Marks:

Class: Pr 6- _____ Register No. _____

Total time for
Booklets A and B: 1 h 45 min

Date: 7 May 2021

Parent's Signature: _____

Booklet B

Instructions to Pupils:

1. For questions 29 to 40, write your answers in the spaces given in this booklet.

	Maximum	Marks Obtained
Booklet A	56 marks	
Booklet B	44 marks	
Total	100 marks	

* This booklet consists of 13 printed pages (including cover page).

This paper is not to be reproduced in part or whole without the permission of the Principal.

For questions 29 to 40, write your answers in the space provided. (44 Marks)

- 29 Lungs in the human body have many tiny air sacs to increase efficiency of gaseous exchange. The diagram below shows how exchange of gasses occurs at one air sac in the lung as blood flows in and out through the blood vessel.

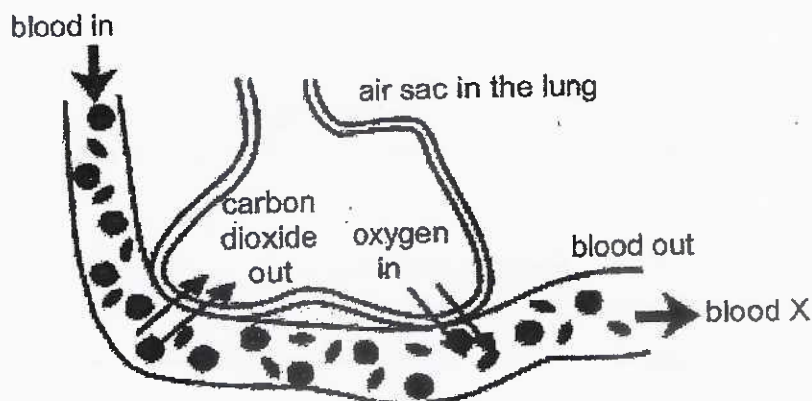

- (a) Which organ will blood X flow to immediately in the human body? [1]

It is found that cigarette smoke damages the walls of the air sacs and thus reduces the number of air sacs in the lungs. The table shows the average breathing rate of a smoker and a non-smoker and the average number of air sacs found in a part of their lungs respectively.

	Average breathing rate (breaths per min)	Average number of air sacs found in a part of the lung
Non-smoker	15	20
Smoker	25	3

- (b) Based on the table, what is the relationship between the number of air sacs in the lungs and the breathing rate? [1]

- (c) Explain why a smoker's breathing rate is higher than a non-smoker. [2]

30 The diagram below shows a plant with its stem partially broken.

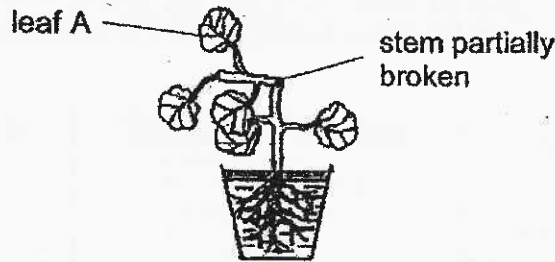

(a) What will happen to leaf A after some time? Explain why. [2]

Lili wanted to conduct an investigation to find out if roots take in water. She prepared a control set-up and an incomplete experimental set-up as shown.

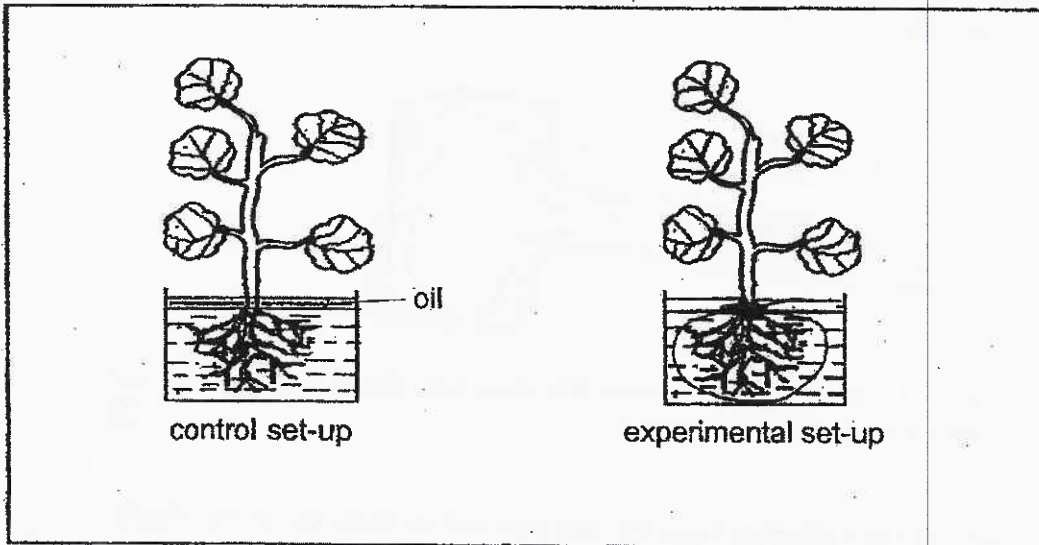

Lili is given the following materials as shown below.

- A cup of oil
- A cup of red dye
- A plastic bag
- A paper bag
- A string

(b) Given the following materials, draw and label the materials to complete her experimental set-up above. You do not need to use all the materials. [2]

Rosyth School/Mid-Year Examination/ Science/P6/2021

- 31 Roger observed three types of cells, A, B and C, under a microscope. He recorded his observations in the table below. A tick (✓) indicates the presence of the cell part.

Cell part	Cell A	Cell B	Cell C
Nucleus	✓	✓	✓
Cell membrane	✓	✓	✓
Chloroplast			✓
Cell wall		✓	

- (a) Name a cell part found in cells, A, B and C, that is not shown in the table above. [1]

Roger drew Cell B which is a root hair cell after observing it under a microscope.

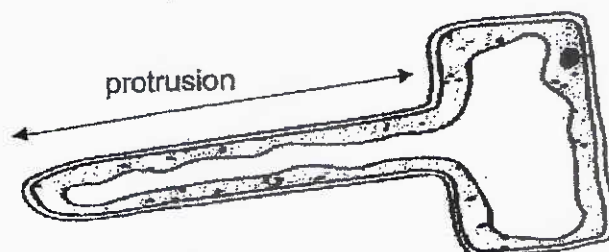

- (b) One part of Cell B is missing from the diagram. Draw the missing part and label it in the diagram above. [1]
- (c) How does the protrusion help the root hair cell to carry out its function? [1]

- (d) Cell C is a single-cell organism. Explain why the organism needs to move towards a light source to survive. [1]

- 32 An experiment was conducted to investigate the effect of two different conditions on the rate of photosynthesis of a water plant.

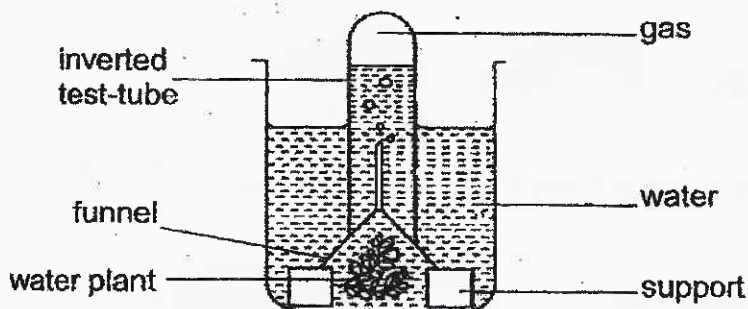

The number of bubbles produced in one minute was counted under four different conditions. The table below shows the results.

Test	Conditions		Number of bubbles of oxygen per minute
	Is there light?	Is carbon dioxide added to the water?	
1	present	no	2
2	absent	no	<input type="text"/>
3	present	yes	20
4	absent	yes	<input type="text"/>

- (a) Predict the results for Test 2 and Test 4 by filling in the boxes in the table above. [1]
- (b) Identify the gas collected in the inverted test-tube. [1]
- _____
- (c) Explain why the water plant in Test 1 could carry out photosynthesis although more carbon dioxide was not added to the water. [1]
- _____
- (d) What is the conclusion of the investigation based on the results in Test 1 and Test 3? [1]
- _____
- _____
- (e) Suggest a way to increase the rate of photosynthesis in the set-up other than changing the two conditions stated in the table above? [1]
- _____

33. The diagram below shows three types of caterpillars, B, C and D, with different body patterns.

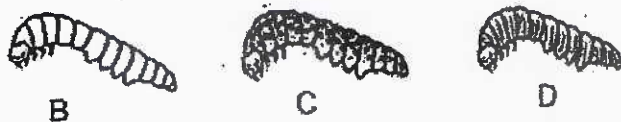

The above caterpillars are found on Plant X. Plant X has two types of leaves, J and K as shown below.



(a) Which type of caterpillar, B, C or D is likely to be found most on leaf K? Explain your answer. [1]

Due to some reasons, all the leaves of plant X lost their patterns as shown below.



(b) What would happen to the population size of caterpillars B, C and D? Tick (✓) the correct answer in the boxes below. [1]

	Population size of _____	Increase	Decrease:
(i)	B		
(ii)	C		
(iii)	D		

(c) Both birds and frogs feed on caterpillar D. Draw a food web below in the box to show the food relationships of the leaves, birds, caterpillar D and frogs. [1]

34 Camels live in extreme hot places.

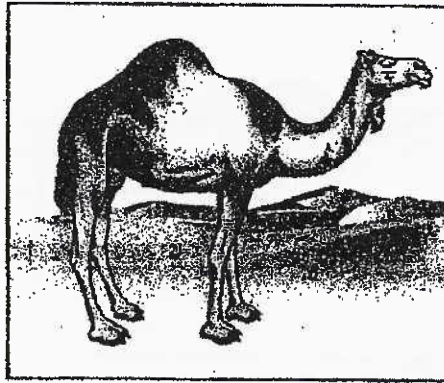

(a) Tick (✓) two features that help the camel to live in an extreme hot conditions.

[1]

Features	Tick (✓)
thick lips	
long legs	
padded feet	
long eyelashes	

(b) Explain how the two features you have ticked help the camel to survive in the extreme hot conditions.

[2]

Feature 1: _____

How it helps:

Feature 2: _____

How it helps:

- 35 The diagram below shows a ceiling fan with a fan motor which moves the fan blades and a lamp that lights up.

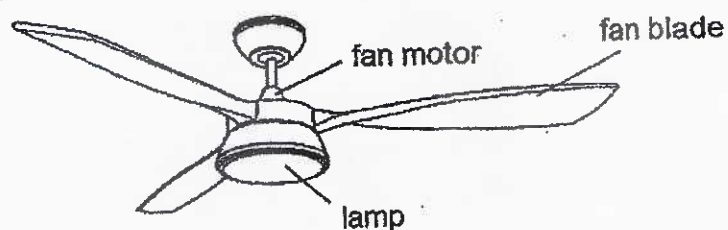

Condition: The fan motor and lamp can be operated independently.

- (a) Complete the circuit below to show how the condition can be met. [3]

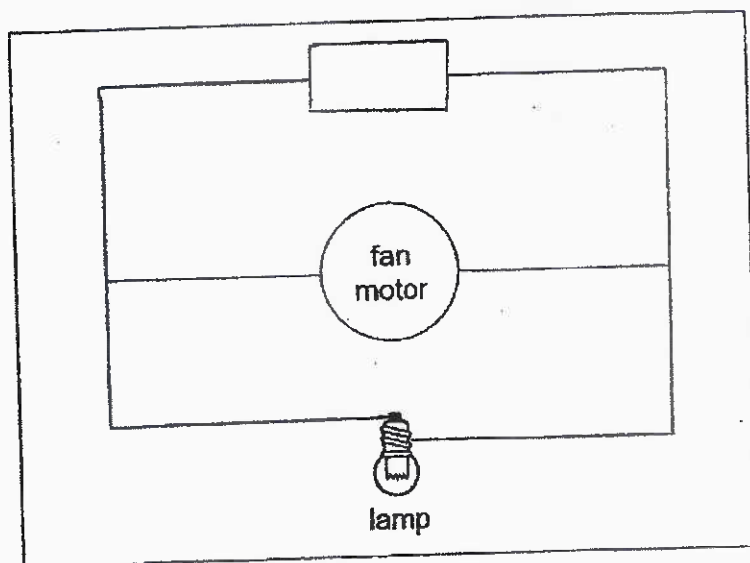

- (b) Indicate where the two switches should be put in your circuit diagram for the above condition to be met. Use crosses (X) to represent the switches. [1]

- 36 The picture shows dew drops formed on a leaf in the morning after a cold night.

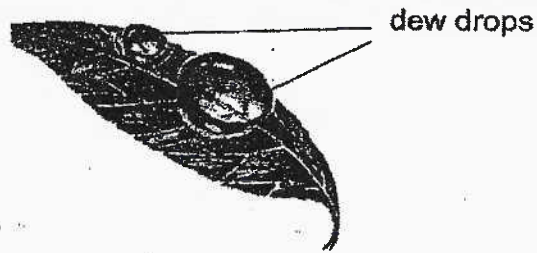

- (a) Describe how the dew drops are formed on the leaf.

[2]

A cup hot water is shown below. The water at the surface loses heat to the surrounding air and it has a lower temperature than the water below the surface.

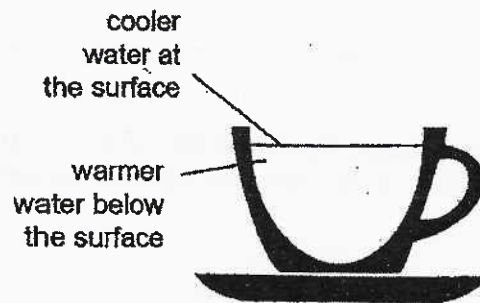

- (b) Explain how the process of evaporation helps the water below the surface to cool down.

[2]

- (c) When will the cup of hot water stop losing heat?

[1]

- 37 A toy cannon has a spring inside to shoot a ball out. When the ball is pushed in, the spring is compressed and the length of the spring is changed. The ball lands on a sand pit and the distance, D , from the cannon is measured.

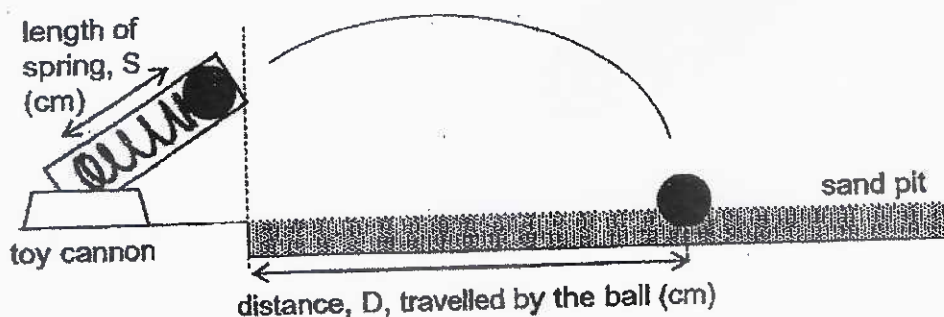

S (cm)	6	5	4	3
D (cm)	15	23	31	39

- (a) What is the aim of the above experiment? [1]

- (b) A bell is now hung in the air above the sand pit, 25cm from the toy cannon. When S is lesser than 4cm, the ball will hit the bell before dropping on the sand pit.

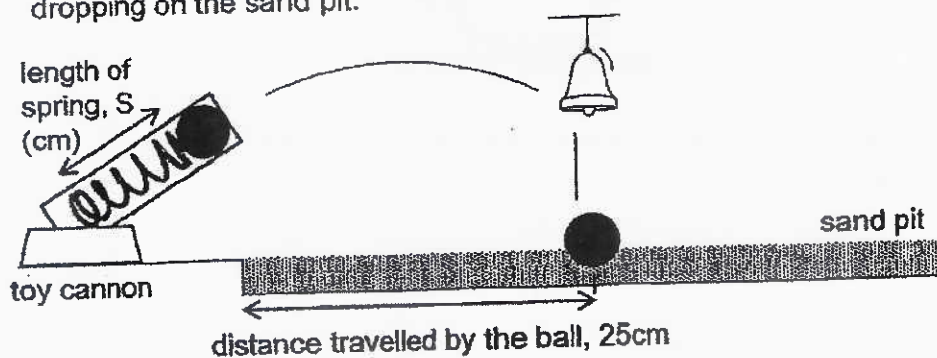

Using conversions of energy, explain why the ball does not go further than 25cm when it hits the bell, even when the spring is compressed more. [2]

- 38 Farmers set up solar watering systems to water their vegetables automatically. Solar panels are connected to electric water pump. The water pump draws water up from the well to water the vegetable plots.

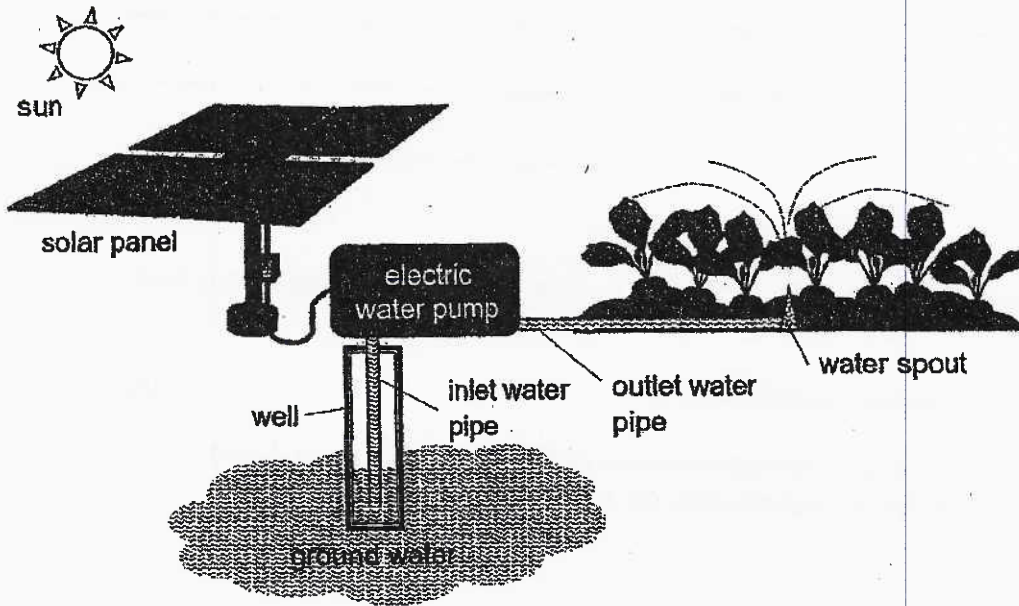

(a) Complete the energy conversion of the watering system. [2]

(i) Solar panel and electric water pump:

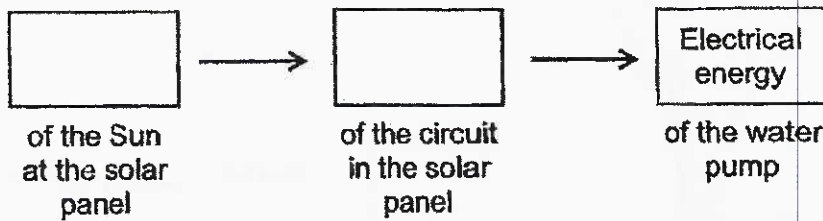

(ii) Water from the well to the water outlet pipe:

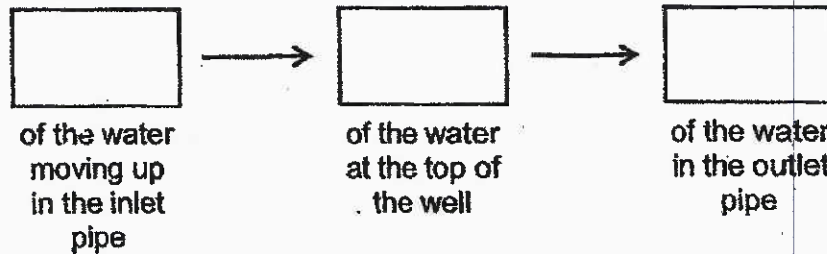

(Question 38 continues next page)

- (b) Explain how the solar watering system will benefit vegetables in sunny Singapore during the dry season. [2]

- 39 Joyce, a parachutist, used a parachute to slow her fall after descending from an aircraft.

In the diagram below, do the following: [2]

- (i) Draw arrows to show the direction of the forces acting on Joyce.
 (ii) Name the forces represented by each arrow respectively.

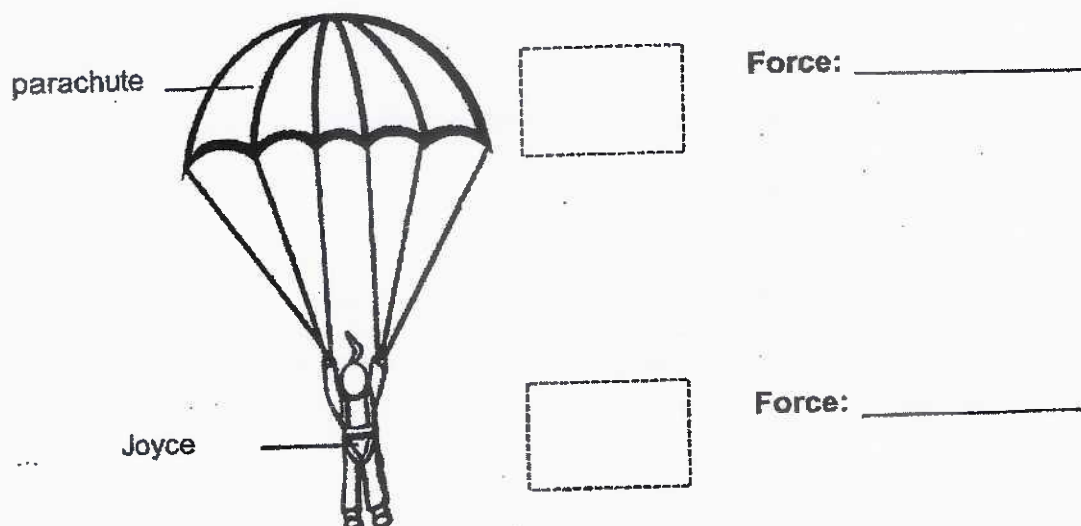

- 40 Jane pulled material J across a cotton cloth and measured the force needed to get it start moving.

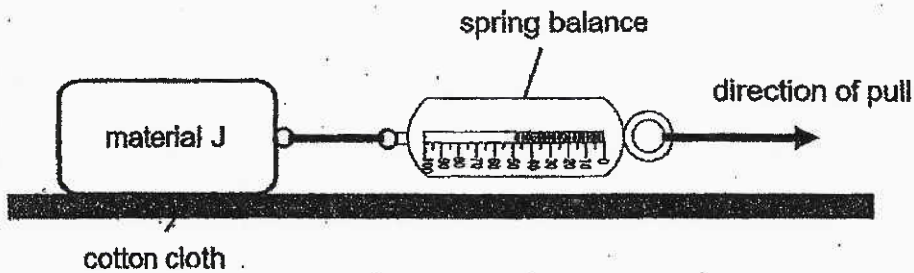

The procedure was repeated with materials K, L and M of the same mass and shape. The results were shown in the table below.

Material	J	K	L	M
Force applied to get the material start moving (units)	48	34	67	86

- (a) Why is a force needed to pull the materials across the cloth? [1]

Face masks with ear loops that are too long often slides down from the nose. Stopper can be fitted on the ear loops to make the ear loops adjustable to suit different head size.

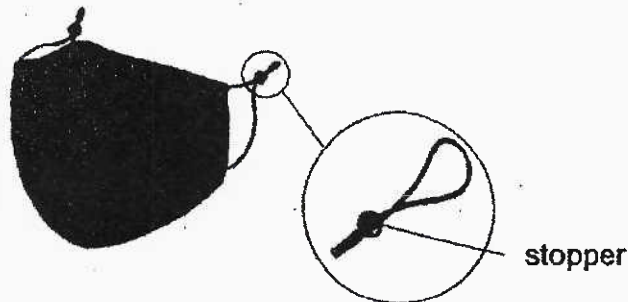

- (b) Which material is most suitable for making the stopper? Explain why. [2]

End of paper



ANSWER KEY

YEAR : 2021
 LEVEL : PRIMARY 6
 SCHOOL : ROSYTH
 SUBJECT : SCIENCE
 TERM : MID-YEAR EXAM

BOOKLET A

Q1	2	Q2	3	Q3	4	Q4	4	Q5	4
Q6	1	Q7	1	Q8	4	Q9	1	Q10	3
Q11	4	Q12	3	Q13	4	Q14	3	Q15	2
Q16	4	Q17	2	Q18	4	Q19	4	Q20	3
Q21	4	Q22	3	Q23	3	Q24	1	Q25	3
Q26	4	Q27	2	Q28	4				

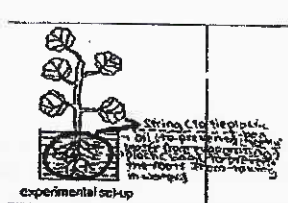
BOOKLET B

Q29	<p>a) Heart</p> <p>b) As the number of air sacs found in a part of the lung increases, the breathing rate decreases.</p> <p>c) A smoker has fewer air sacs, so less oxygen is absorbed into the bloodstream from his air sacs, making him breathe faster to take in the same amount of oxygen as a non-smoker.</p>
Q30	<p>a) Leaf A will die. Water absorbed by the roots will not be able to be transported to leaf A as the xylem had broke.</p> <p>b)</p> 
Q31	<p>a) Cytoplasm</p> <p>b)</p>  <p>c) It has a greater exposed surface area in contact with the moist soil so it can absorb more water at a faster rate.</p>

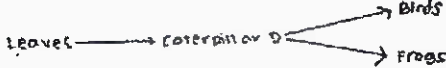
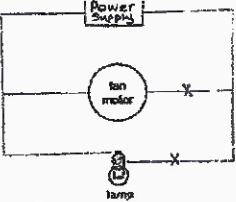
	d) Cell C has chloroplast. It needs to move towards a light source so the chlorophyll in the chloroplasts can trap light to make food and photosynthesis.
Q32	<p>a) 2 : 0 4 : 0</p> <p>b) Oxygen</p> <p>c) There was already some dissolved carbon dioxide in the water.</p> <p>d) As the amount of carbon dioxide increases. The rate of photosynthesis increases.</p> <p>e) Increase the temperature at the place where the set-up is placed at.</p>
Q33	<p>a) Caterpillar C. Caterpillar C has dots on its body just like leaf k. Staying on leaf k can protect caterpillar C as it can camouflage and be less easily spotted by predators.</p> <p>b) i) B : increase ii) C : decrease iii) D : decrease</p> <p>c)</p> 
Q34	<p>a) Long legs , Padded feet</p> <p>b) Feature 1 : long legs How it helps : It helps the camel move more comfortably as it reduces surface area in contact with the hot sand. Feature 2 : padded feet It has padded feet to reduce heat gain from the hot sand.</p>
Q35	<p>a)</p> <p>b)</p> 
Q36	<p>a) Water vapour in the surrounding air touches the cooler surface at the leaf, lose heat and condensed into dew drops.</p> <p>b) Water at the surface will gain heat from the water below the surface to evaporated, so the remain in hot water in the cup cools down.</p> <p>c) When the hot water reach the room temperature.</p>
Q37	a) To find out if the length of spring affect the distance travelled by the ball.

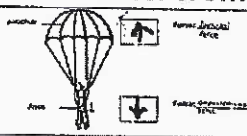
	<p>b) The kinetic energy of the ball that allows it to fly further is now converted to heat and sound energy when it hits the bell. So, with less kinetic energy to move forward it bell.</p>
Q38	<p>a) (i) : light energy → electrical energy → electrical energy (ii) : kinetic energy → gravitational potential energy → kinetic energy b) Singapore is sunny so the solar panel will convert light energy to electrical energy so the electrical water pump can run to draw water from the ground to water the plants to continue growing.</p>
Q39 i) ii)	 <p>Force : Frictional Force Force : Gravitational Force</p>
Q40	<p>a) Force is needed to overcome friction between the materials and the cloth. b) Material M. M needs the greatest force to make it start moving along the ear loop. So it will have the greatest friction to overcome before the mask will come loose.</p>

3
END

