

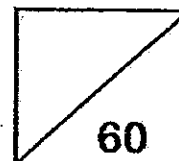

Rosyth School
Preliminary Examination 2013
STANDARD SCIENCE
Primary 6



Name: _____

Total
Marks:

Class: Pr 6 _____ Register No. _____ Duration: 1 h 45 min

Date: 29th August 2013 Parent's Signature: _____

Booklet A

Instructions to Pupils:

1. Do not open the booklets until you are told to do so.
2. Follow all instructions carefully.
3. This paper consists of 2 booklets - Booklet A and Booklet B
4. For questions 1 to 30 in Booklet A, shade the correct ovals on the Optical Answer Sheet (OAS) provided using a 2B pencil.
5. For questions 31 to 44, give your answers in the spaces given in the Booklet B.

* This booklet consists of 19 pages.

This paper is not to be reproduced in part or whole without the permission of the Principal.

PART I (60 MARKS)

For each question from 1 to 30, four options are given. One of them is the correct answer. Make your choice (1, 2, 3 or 4). Shade the correct oval (1, 2, 3 or 4) on the Optical Answer Sheet.

1 The diagram below shows how some animals can be classified.

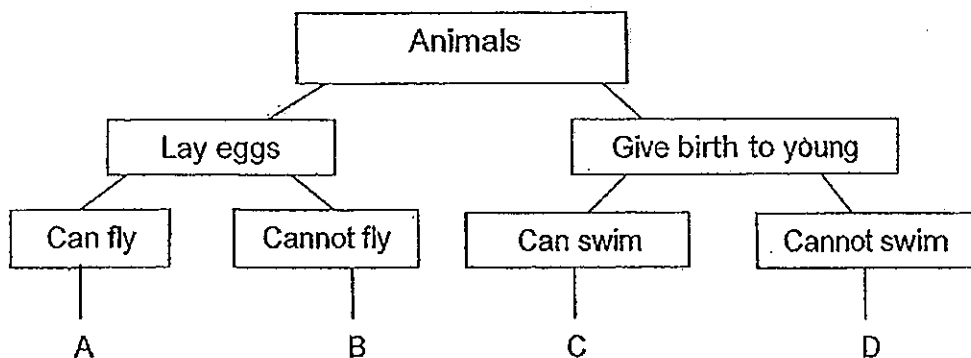

A platypus is a mammal that lays eggs. It can swim but cannot fly.
Which group does the platypus belong to?

- (1) A (2) B
(3) C (4) D

2 Which of the following statements correctly compare the difference between air that is inhaled and air that is exhaled by a healthy person?

- A: Inhaled air is cooler than exhaled air.
B: Exhaled air has less oxygen than inhaled air.
C: Inhaled air has less water vapour than exhaled air.
D: Exhaled air has more dust particles than inhaled air.

- (1) A and C only (2) B and D only
(3) A, B and C only (4) B, C and D only

3 Which of the following organisms break down dead matter into simple substances?

- A: yeast
B: maggots
C: earthworms
D: bread mould

- (1) A and D only (2) B and C only
(3) A, B and C only (4) B, C and D only

- 4 A group of students measured the temperature in a particular place at six-hourly intervals for two days. The temperature was recorded in the air, in the water of a shallow pond at a depth of 15 cm and in the soil at a depth of 15 cm. Using the data collected, they plotted a graph to show how the temperature in the air, in the water and in the soil changes over the two days as shown below.

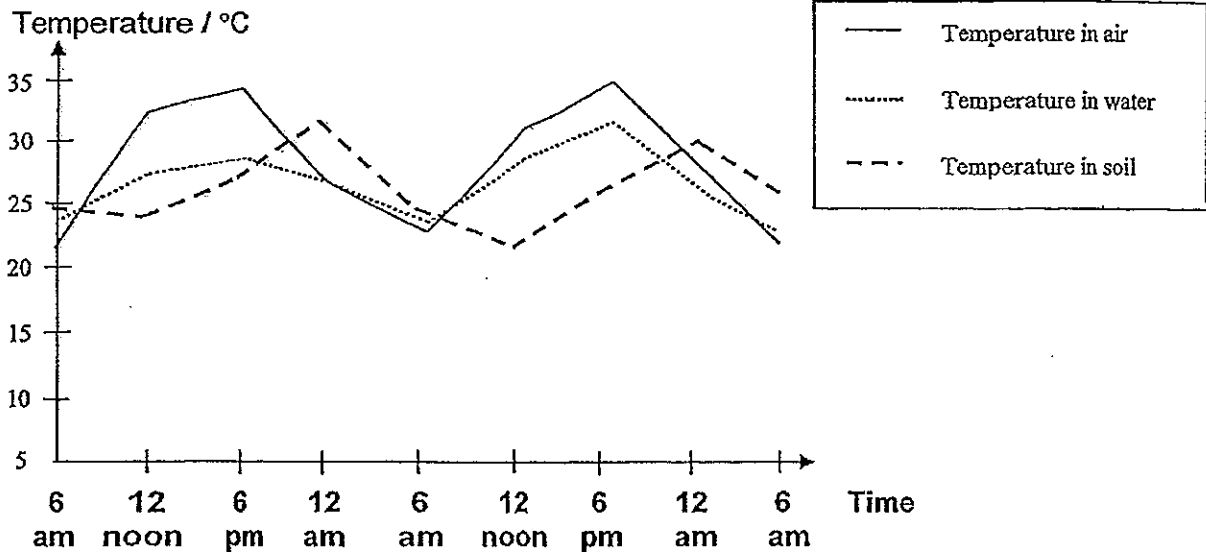

What can the students infer from the graph about the temperature variations?

- (1) The lowest temperature in air was recorded at 12 am daily.
- (2) The soil temperature varied by the same amount each day.
- (3) The temperature in water changed the least over this time period.
- (4) At any one time, the air temperature is always higher than the water temperature.

- 5 The diagram below shows the human digestive system.

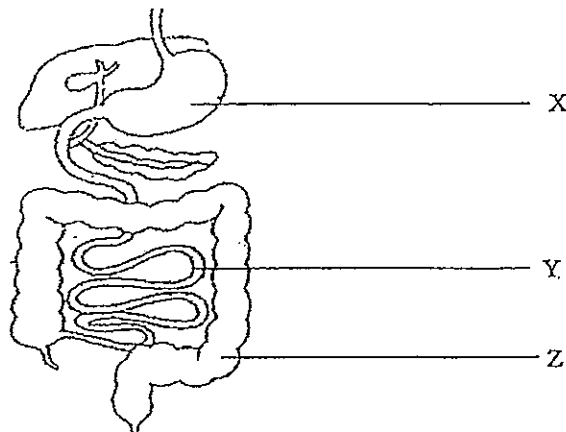

In which parts does digestion of food takes place?

- (1) X and Z only
- (2) Y and Z only
- (3) X and Y only
- (4) X, Y and Z

6 A team of scientists recovered twenty-six bacteria from a spacecraft. They carried out an experiment to find out if the bacteria could grow under different conditions.

The results of their investigation for each set-up are shown below.

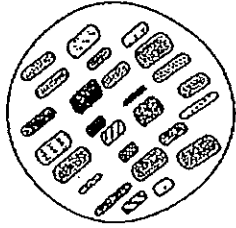

Set-up A: Under normal Earth pressure and oxygen and 30 °C

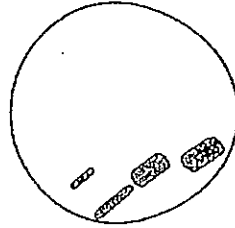

Set-up B: Under normal Earth pressure and oxygen and 0 °C

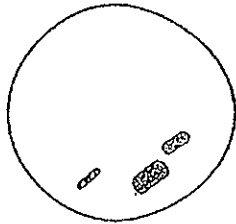

Set-up C: Under normal Earth pressure, no oxygen and 0 °C

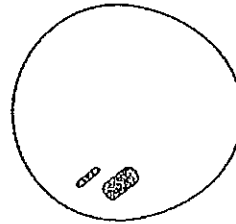

Set-up D: Under very low pressure, no oxygen and 0 °C

Based on the results of their investigation, which of the following statement(s) is/are true?

- A: Different bacteria can survive under different conditions.
- B: Some bacteria can survive with freezing temperature and no oxygen.
- C: Some bacteria can still survive when the temperature is dropped to 0 °C.

- (1) B only
- (3) B and C only

- (2) A and B only
- (4) A, B and C

- 7 The diagram below shows the developmental stages of a flowering plant and the point at which fertilisation occurs.

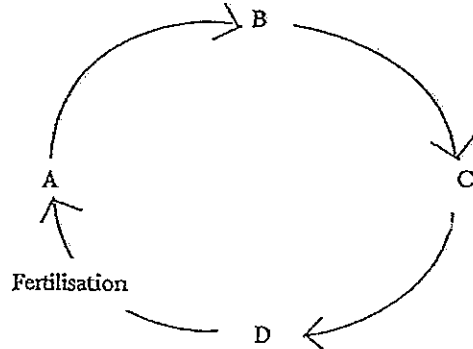

Which one of the following shows the correct stages?

	A	B	C	D
(1)	adult plant	seed	seedling	young plant
(2)	seed	seedling	young plant	adult plant
(3)	seedling	young plant	adult plant	seed
(4)	young plant	seed	seedling	adult plant

- 8 A group of students collected a sample of water from two different parts of a pond, one that has clear water and the other, murky water containing decaying matter.

They placed 5 ml of each sample of water into a test-tube each and labelled them as Sample P and Sample Q. Next, they added 20 drops of an indicator solution to each test tube and observe them at every 10-minute interval for 1 hour.

The indicator solution is an indicator of oxygen. In the presence of oxygen, it remains blue but as the amount of oxygen decreases, the indicator turns colourless.

The table below shows their observations.

Sample	Observations
P	Blue colour disappeared.
Q	The indicator solution remained blue.

What is the most likely explanation for their observation in Sample P?

- (1) Some animals took in the oxygen as they respire in the murky water.
- (2) The amount of oxygen has decreased as it dissolved in the murky water.
- (3) Bacteria gave out carbon dioxide during decomposition of the decaying matter in the murky water.
- (4) Bacteria took in the oxygen as they involved in decomposition of the decaying matter in the murky water.

Refer to the information given below and answer Questions 9 and 10.

Some students carried out an experiment by using the set-up as shown below.

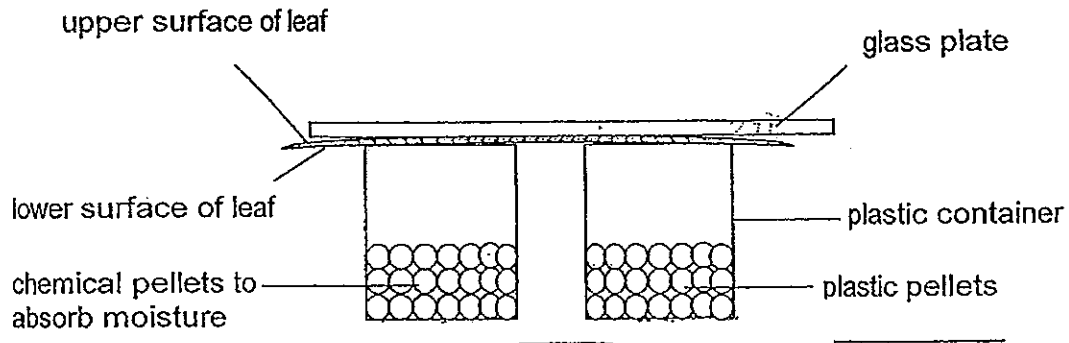

The leaf has two plastic containers pressed against its lower surface and a glass plate pressing down on top. The set-up was then left under the sun for 6 hours.

The students then removed the leaf and tested it for the presence of starch.

9 Which of the following is/are possibly the aim(s) of the experiment?

- A: To find out the conditions for photosynthesis to take place.
- B: To find out if water is needed for photosynthesis to take place.
- C: To find out if the presence of starch on the leaf is affected by the presence of water.

(1) B only.

(2) C only

(3) A and C only

(4) B and C only

10 Which of the following shows the results of the starch test?

(1) brownish yellow stains

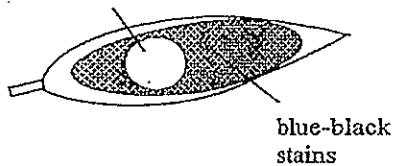

(2) blue-black stains

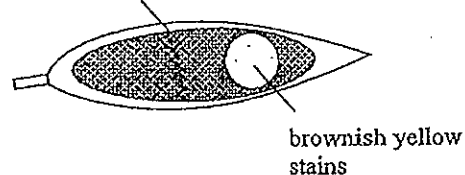

(3) brownish yellow stains

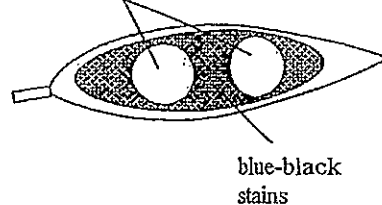

(4)

brownish yellow stains

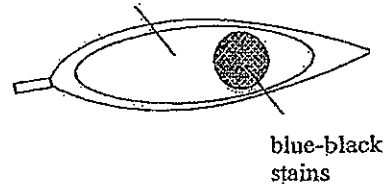

11 The diagrams below show a cross section of a leaf and a root cell.

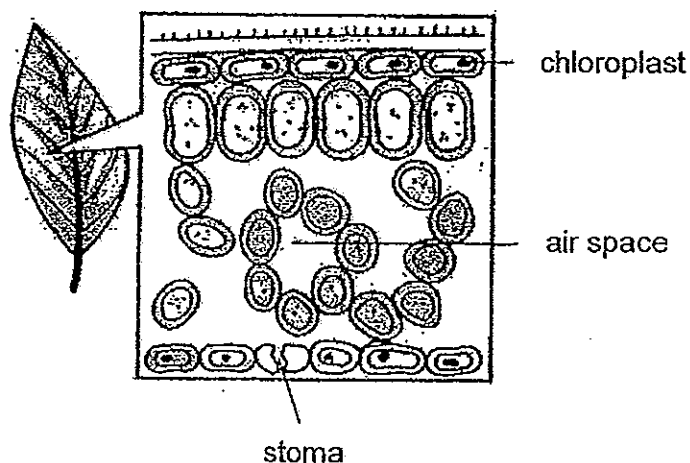

Cross section of a leaf

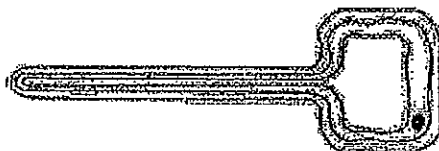

A root cell

Both cells have adapted their structures to best suit their functions.

Which of the following correctly show the adapted structure and its function for photosynthesis to take place?

	Adapted Structure	Function
A	Lots of chlorophyll in the chloroplasts positioned at the top of the cell.	To capture the maximum amount of light for use in photosynthesis.
B	The size of each stoma can be controlled.	To allow for gaseous exchange with the atmosphere.
C	The root cell has an elongated structure.	To provide a greater surface area for water absorption.

(1) A only

(3) B and C only

(2) A and C only

(4) A, B and C

- 12 The diagram below shows the life cycle of a mosquito.

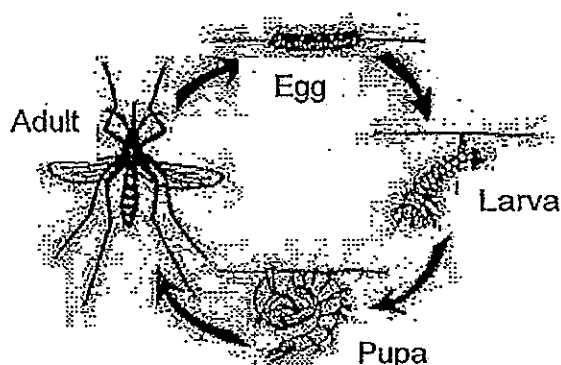

Which of the following statements are true?

- A: The larvae live in the water and come to the surface to breathe through a breathing tube.
 B: Controlling and reducing the populations of mosquitoes would help prevent dengue.
 C: The young of the mosquito lives in water while the adult lives on land to ensure the survival of the species.
 D: To prevent mosquitoes from breeding and mosquito bites, the breeding of mosquitos should be controlled at the larval and pupal stages only.

- (1) A and B only
 (3) B, C and D only

- (2) A, B and C only
 (4) A, B, C and D

- 13 The table below shows some adaptations of desert and floating plants.

	Type of Plant	Environment	Adaptation	Reason
A	Desert	Hot and Dry	Has leaves and stems that store water	To provide the water the plant needs during the dry months.
B	Desert	Hot and Dry	Has waxy leaves	To keep the stomata open and clear.
C	Floating	Aquatic	Has air-filled spaces	To help the plant stay afloat.
D	Floating	Aquatic	Has waxy leaves	To slow down water loss through transpiration.

Which of the following are the incorrect matches between the adaptation and the reason?

- (1) A and B only
 (3) B and D only

- (2) A and C only
 (4) C and D only

- 14 Lee Meng carried out an experiment using flowers of a plant as shown below. He removed some parts of the flowers, A and B. He then transferred some pollen grains from another flower of the same plant to the remaining parts of each flower. He observed if fruits were formed after that.

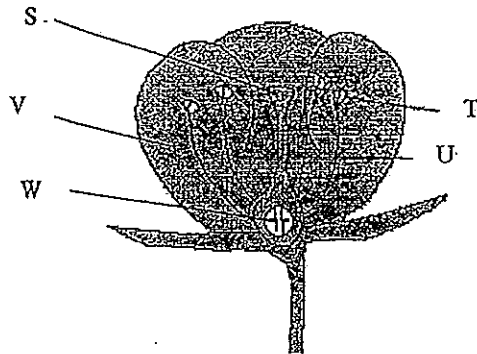

The results of his experiment are shown below.

Flower	Results
A	A fruit is formed.
B	No fruit is formed.

Which one of the following shows the parts of each flower that have been removed?

Parts removed		
	Flower A	Flower B
(1)	S, V	T, U, W
(2)	T, V	S, T
(3)	V, W	T, U
(4)	T, U	T, U

- 15 David carried out an investigation on the growth of seedlings. He planted some green beans in a container with some moist cotton wool and placed the set-up in the living room. When the green beans have germinated, he removed 2 of them and placed one in another container with moist cotton wool. He gently removed the seed leaves of the other germinated seed and planted the seedling in another similar container with moist cotton wool. He placed both containers in his living room and observed the growth of both seedlings over 10 days.

Graph A below shows the mass of the seedling and the mass of the seed leaves while Graph B shows the mass of the seedling with the seed leaves removed.

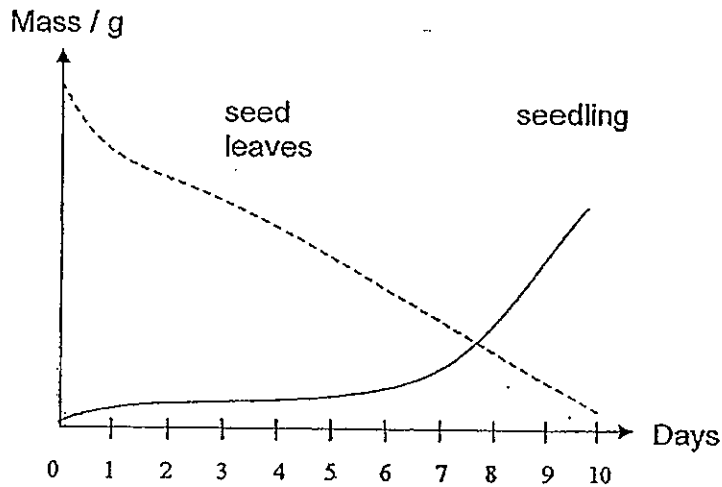

Graph A

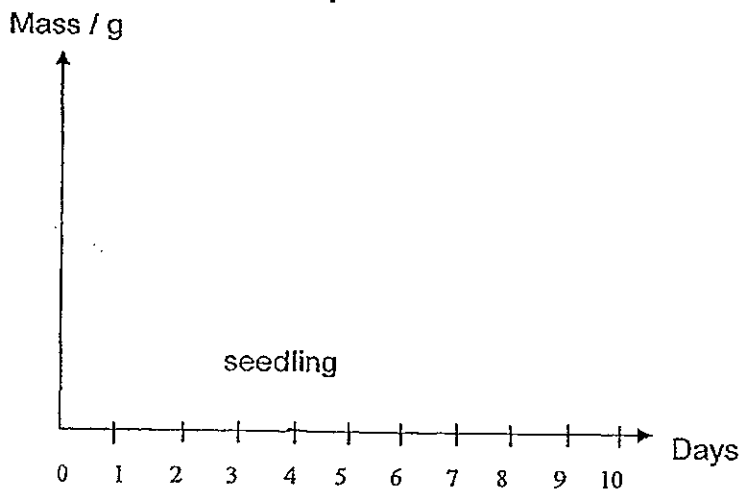
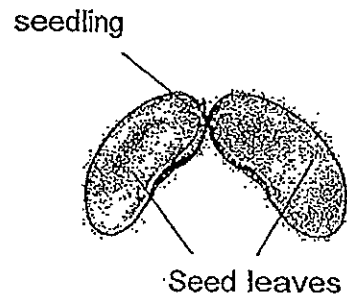

Graph B

Based on the graphs, what can you conclude about the growth of the seedling?

- (1) The roots of the seedling grow downwards first followed by the shoot.
- (2) The seedling depends on the food stored in the seed leaves for its growth.
- (3) The mass of the seed leaves decreases as the mass of the seedling increases.
- (4) The seedling can only make its own food when its first pair of leaves has developed.

- 16 The graph below compares the strength and the mass of 4 similar-sized metal alloy bars, A, B, C and D. Metal alloys are mixtures of two or more metals.

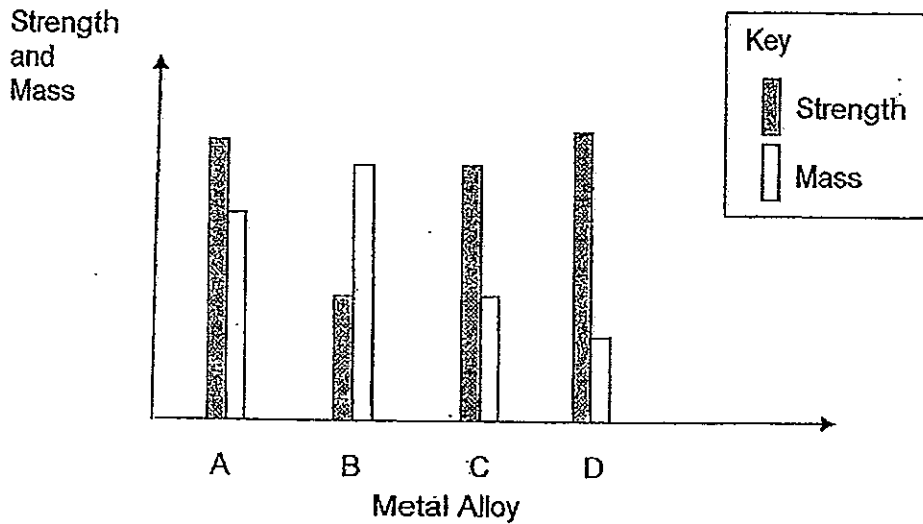

Which one of the alloys, A, B, C or D, is most suitable for making the frame of a racing bicycle which requires the metal alloy to be both strong and lightweight?

- (1) A
 (2) B
 (3) C
 (4) D
- 17 A beaker of water was heated and the change in the mass of water was recorded at 2-minute intervals. The results were recorded and plotted into a line graph. Which of the following line graphs is most likely the correct representation of the results of the experiment?

(1) Mass of water (g)

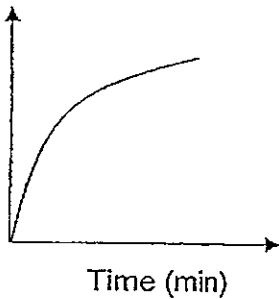

(2) Mass of water (g)

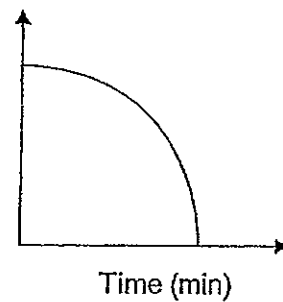

(3) Mass of water (g)

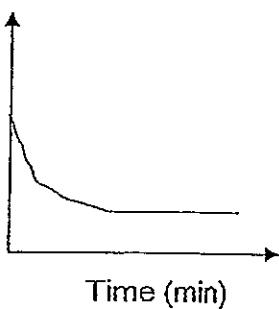

(4) Mass of water (g)

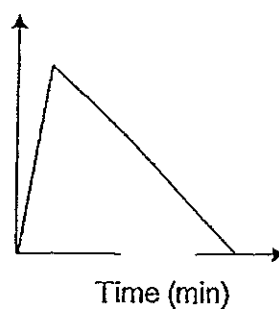

- 18 Peter found a stone and a marble on the floor. He lowered each of the items carefully into a measuring cylinder containing 50 cm³ of coloured water as shown below.

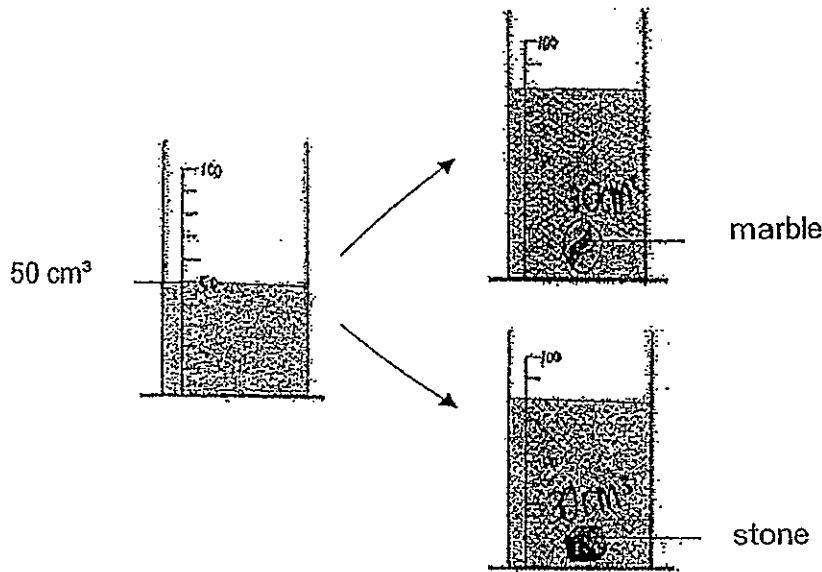

Which of the following conclusions would he make from the above set-up?

- A: The volume of the stone is 80 cm³.
- B: The marble and the stone have the same volume.
- C: The water level in the measuring cylinder rose as the marble and stone occupy space.
- D: The water level in the measuring cylinder rose as the marble and stone have mass.

- (1) A and C only
- (3) B and C only

- (2) A and D only
- (4) B and D only

- 19 Rachel wanted to find out the rate of evaporation of water in the container as shown below.

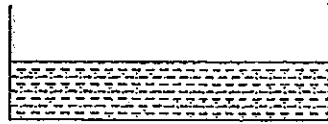

Rachel then recorded the changes in the rate of evaporation of the water over a period of time and plotted the results in the graph below.

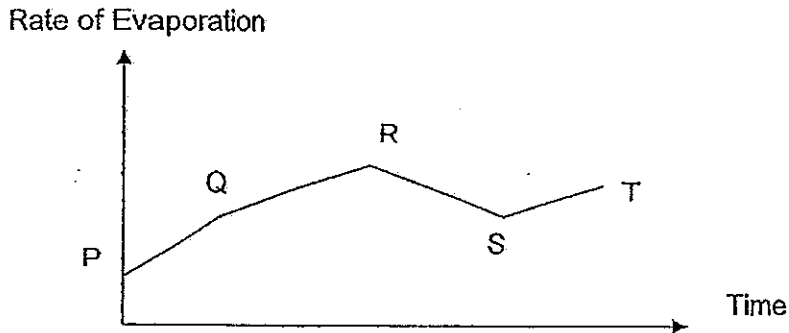

Which of the following are possible reasons for the above changes in the rate of evaporation?

- A: During PQ, there was a lot of water in the container.
- B: During QR, there was an increase in the exposed surface area of water.
- C: During RS, there was a decrease in the temperature of the surrounding air.
- D: During ST, there was an increase in the speed of wind.

- (1) A and B only
- (2) A, B and C only
- (3) C and D only
- (4) B, C and D only

- 20 The diagram below shows an electric circuit.

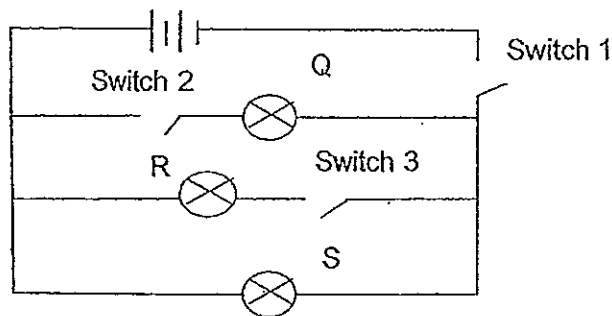

In which order must the switches be closed so that Bulb S lights up first, followed by Bulb R and then Q?

	First switch to close	Second switch to close	Third switch to close
(1)	1	2	3
(2)	3	1	2
(3)	2	3	1
(4)	1	3	2

- 21 Ricky had three rods, A, B and C, each made of a different material. He placed them at positions 1, 2 and 3 respectively in an electric circuit as shown below.

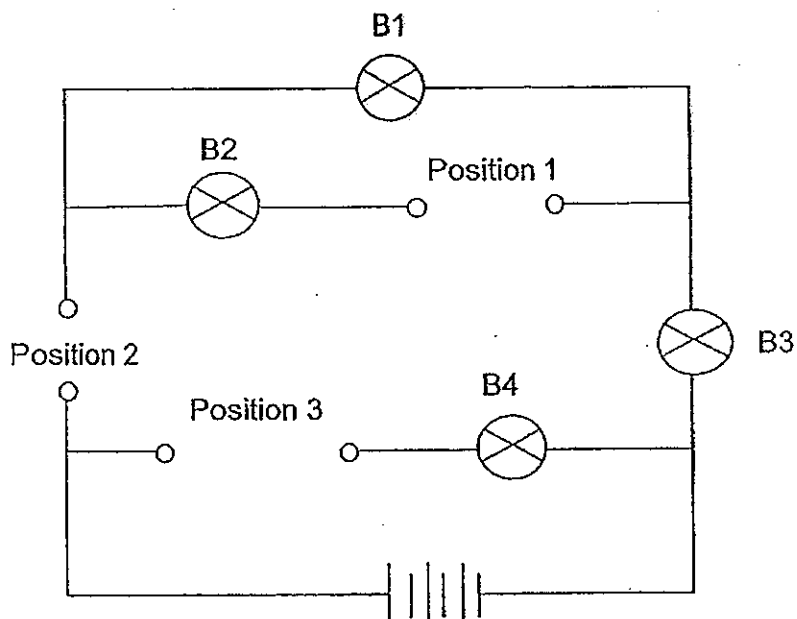

He recorded his observations in the table below.

Position of each rod			Did the bulbs light up?			
1	2	3	B1	B2	B3	B4
A	B	C	Yes	Yes	Yes	No

He then rearranged the positions of rods A, B and C.

Which one of the following observations matches correctly to the new positions of the rods in the circuit?

	Position of each rod			Did the bulbs light up?			
	1	2	3	B1	B2	B3	B4
(1)	A	C	B	No	No	Yes	Yes
(2)	C	A	B	Yes	No	Yes	Yes
(3)	C	A	B	No	Yes	Yes	Yes
(4)	B	C	A	Yes	No	Yes	No

- 22 Philip tested four objects, P, Q, R and S, made of magnetic material by using the apparatus shown in the diagram.

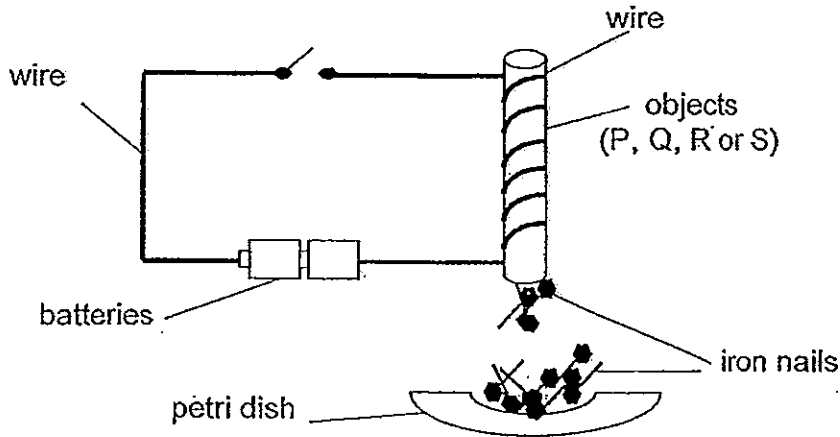

When the switch was closed, the object picked up some of the iron nails but when the switch was opened, some of the nails fell off. Philip counted the number of nails picked up and the number left on the four objects. He then recorded the results in the table below.

Object	Number of pins picked up when switch was closed	Number of pins left on the objects when switch was opened
P	40	15
Q	20	5
R	20	10
S	35	4

Philip wanted to use one of the objects above to make an electromagnet which is able to separate iron and steel from the rubbish and load them onto a lorry for recycling in a fastest time.

Based on the results obtained, which one of the objects is most suitable for making the electromagnet?

- (1) P (2) Q
(3) R (4) S

- 23 The diagram below shows a glass tube with a marble placed at one end. When the marble is released, it rolls to the other end of the tube before rolling back downwards.

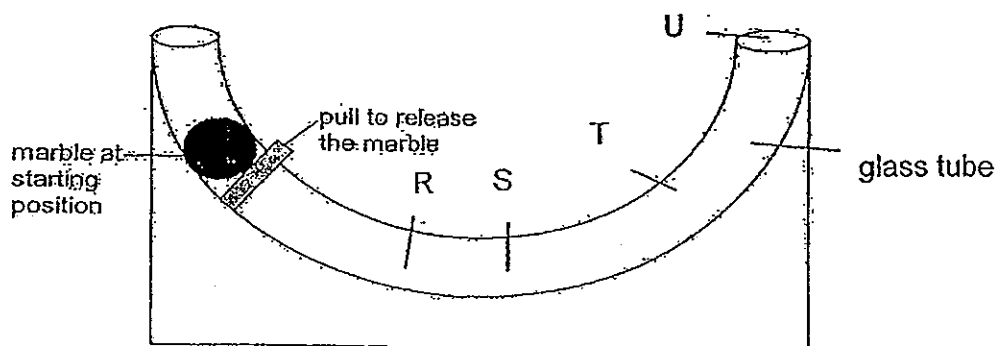

At which position, R, S, T or U, will the marble reach before it rolls back downwards?

- (1) R (2) S
 (3) T (4) U
- 24 Mary's teacher gave her 2 different wooden blocks, a spring balance and 2 similar ramps: one made of glass and the other, wood. She used the materials to prepare set-ups, M and N, as shown below.

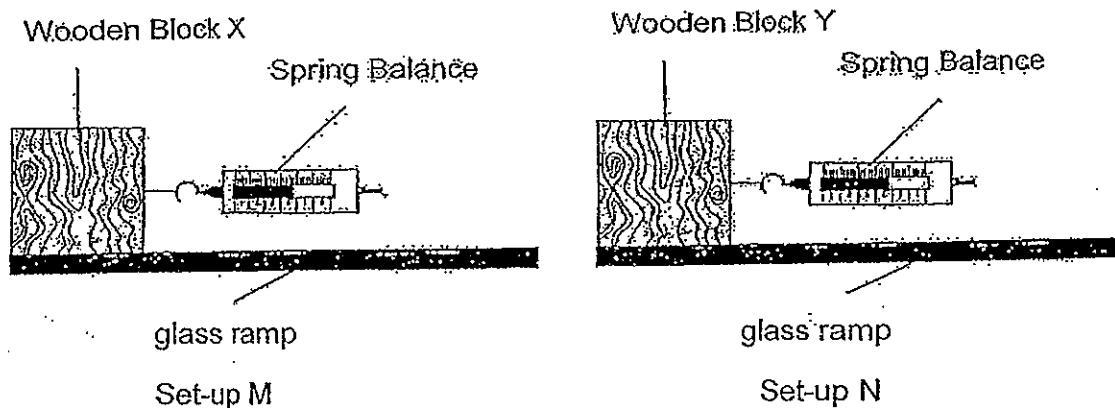

Mary wanted to find out how the type of surface affects the force needed to move a block. Mary's teacher observed the set-ups and said that what she did was wrong.

What must Mary do to Set-up N in order for her to carry out her investigation?

- A: Use wooden block X instead of wooden block Y.
 B: Use the wooden ramp instead of the glass ramp.
 C: Pull the wooden block from a different position as compared to Set-up M.

- (1) A only (2) A and B only
 (3) B and C only (4) A, B and C

25 Derrick had 4 pieces of paper of different shapes and made of different materials as shown below.

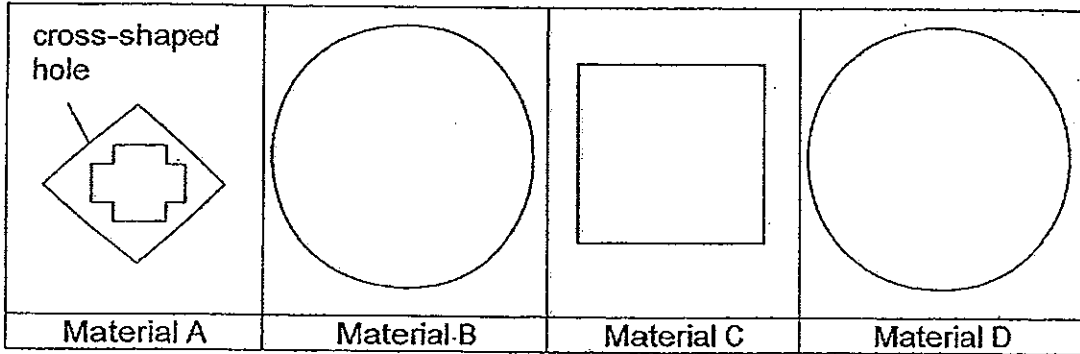

He placed the 4 different materials one in front of the other as shown in the diagram below and shone a torch in front of them.

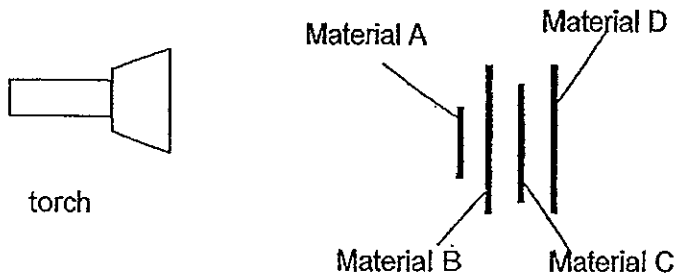

Derrick then recorded his observations on Material C and D as shown below.

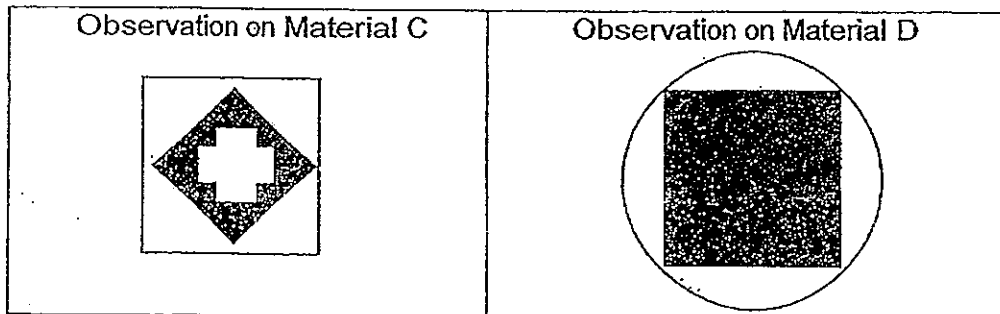

Which of the following shows the degree of transparency of Material A, B, C and D respectively?

	Material A	Material B	Material C	Material D
(1)	opaque	transparent	transparent	opaque
(2)	transparent	transparent	opaque	opaque
(3)	opaque	opaque	opaque	transparent
(4)	opaque	transparent	opaque	opaque

26 Sandra accidentally dropped her ball that glowed in the dark into a deep drain. She wanted to retrieve her ball but she could not see it.

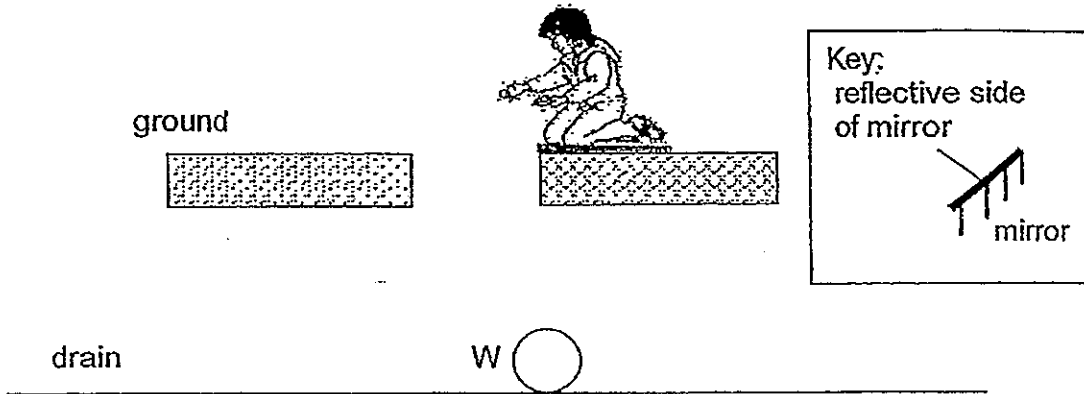

Sandra then lowered a mirror, attached to a string, to position W in the drain.

At which angle should Sandra place the mirror to see the ball in the drain?

(1)

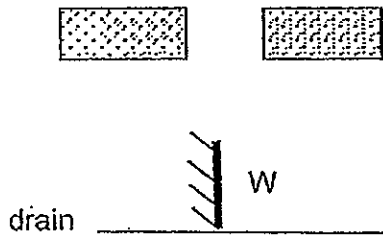

(2)

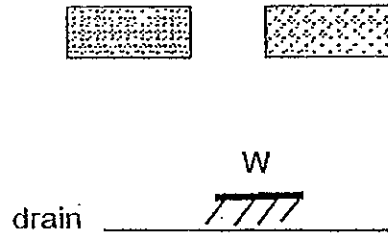

(3)

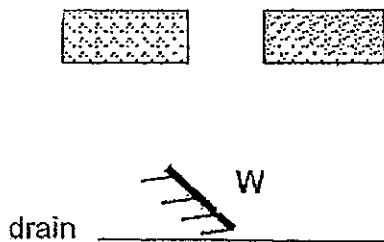

(4)

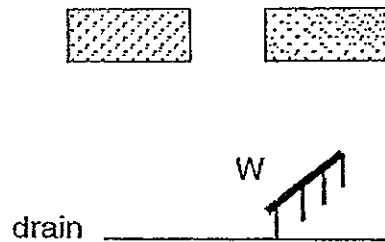

- 27 Vivien was given 2 different metal rods, X and Y, of the same thickness and length. She wanted to conduct an experiment to find out which one of these two rods, X and Y, is a better conductor of heat.

The diagram below shows four possible set-ups, A, B, C and D.

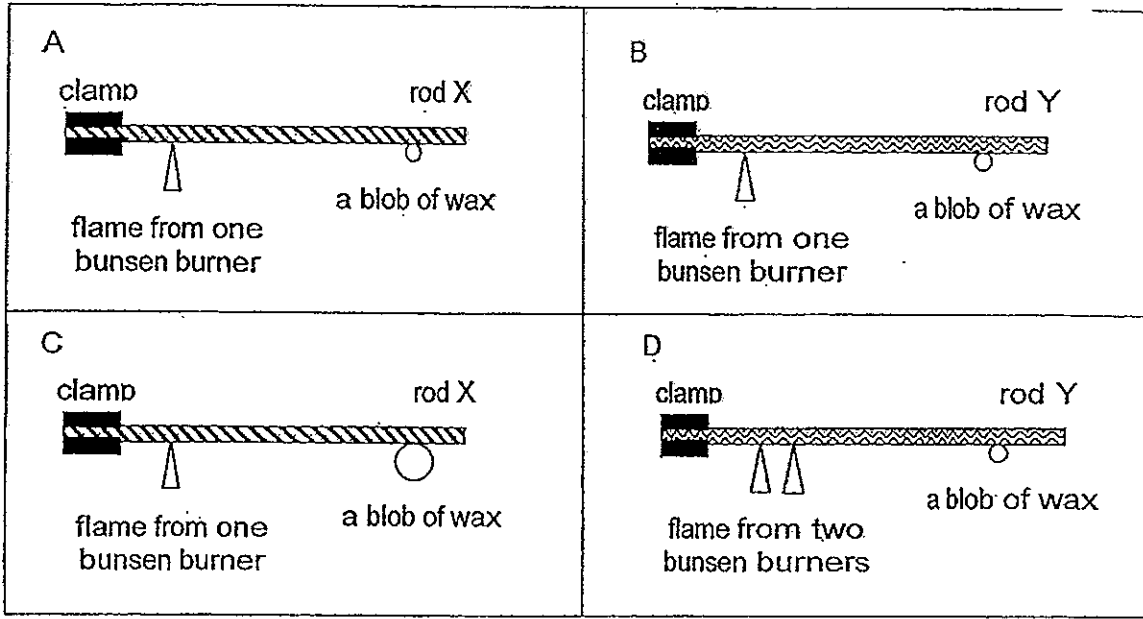

Which two set-ups should Vivien use to conduct her experiment in order to ensure a fair test?

- (1) A and B (2) A and C
(3) B and C (4) C and D
- 28 Chong Boon filled a baking pan with ice shavings completely. He placed four different coloured cloths of the same material, equally spaced out, directly on the ice shavings as shown below.

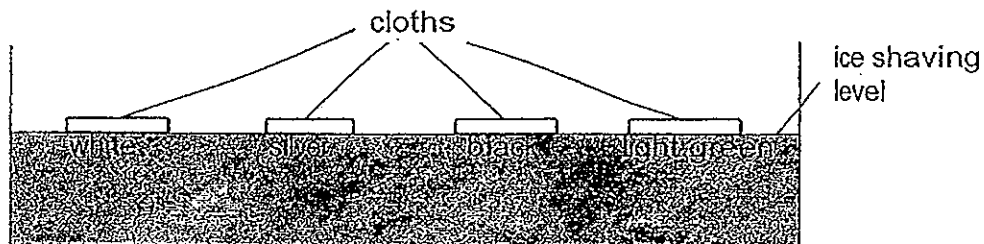

He left the pan in a hot place and made his observation.

Which coloured material will sink into the ice shavings first?

- (1) white (2) silver
(3) black (4) light green

29 Study the 4 set-ups W, X, Y and Z below carefully.

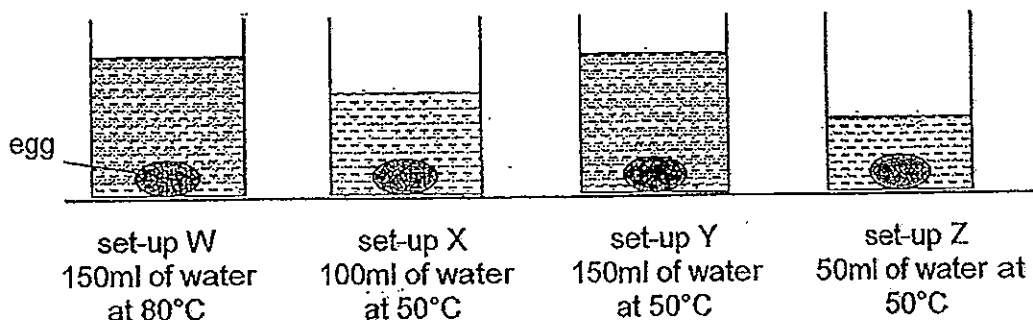

The four beakers were filled with different amounts of water at different temperatures. Four identical eggs were each gently put into each of the beakers. They were left in the beakers for 2 minutes. After 2 minutes, the eggs were taken out and cracked to see how cooked each of the eggs was.

Which one of the following shows the correct arrangement of the set-ups with the egg that was most cooked to the egg that was least cooked?

- (1) W, X, Y and Z
 (2) W, Y, X and Z
 (3) Z, Y, X and W
 (4) Z, X, Y and W

30 Peter placed a small metal block weighing 350g and a big plastic block weighing 240g on top of his cupboard in his bedroom.

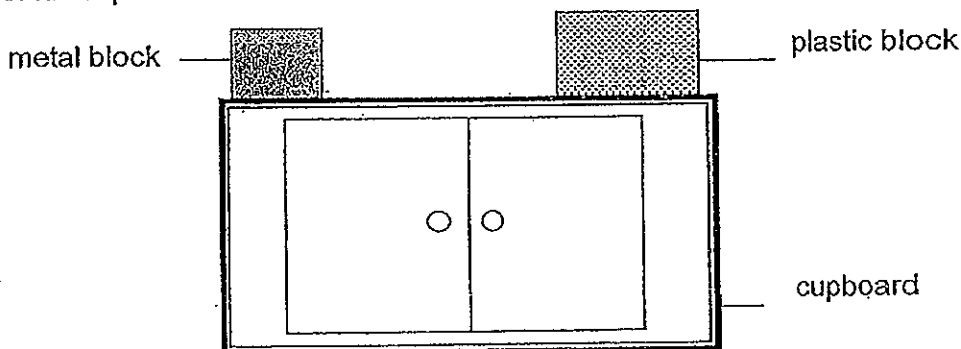

Which one of the following statements about the plastic block and metal block is true?

- (1) Both blocks do not have any gravitational potential energy because they are at rest.
 (2) The metal block has greater amount of gravitational potential energy because it has greater mass.
 (3) The plastic block has greater amount of gravitational potential energy because it takes up more space.
 (4) Both blocks have the same amount of gravitational potential energy because they are at the same height.

End of Part I



Rosyth School
Preliminary Examination 2013
STANDARD SCIENCE
Primary 6

Name: _____

Total
Marks:

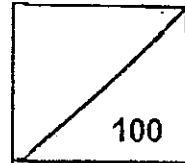

Class: Pr 6 _____ Register No. _____ Duration: 1 h 45 min

Date: 29th August 2013 Parent's Signature: _____

Booklet B

Instructions to Pupils:

1. For questions 31 to 44, give your answers in the spaces given in Booklet B.

	Maximum	Marks Obtained
Booklet A	60 marks	
Booklet B	40 marks	
Total	100 marks	

* This booklet consists of 15 pages.

This paper is not to be reproduced in part or whole without the permission of the Principal.

PART II (40 MARKS)

For questions 31 to 44, write your answers in this booklet.

31 The food web below shows what some animals eat.

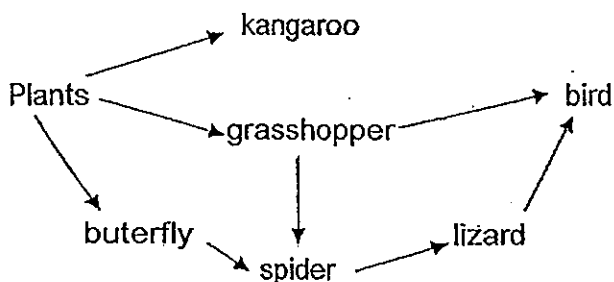

(a) If insecticide killed most of the insects in the area, which animal would be the least affected? Give a reason for your choice. [1m]

(b) Based on the food web, write a food chain involving the most number of organisms. [1m]

(c) Explain why there is a decrease in the amount of energy from one organism to another in a food chain. [1m]

- 32 The diagrams below show how materials are being transported in the plant transport system and the human circulatory system.

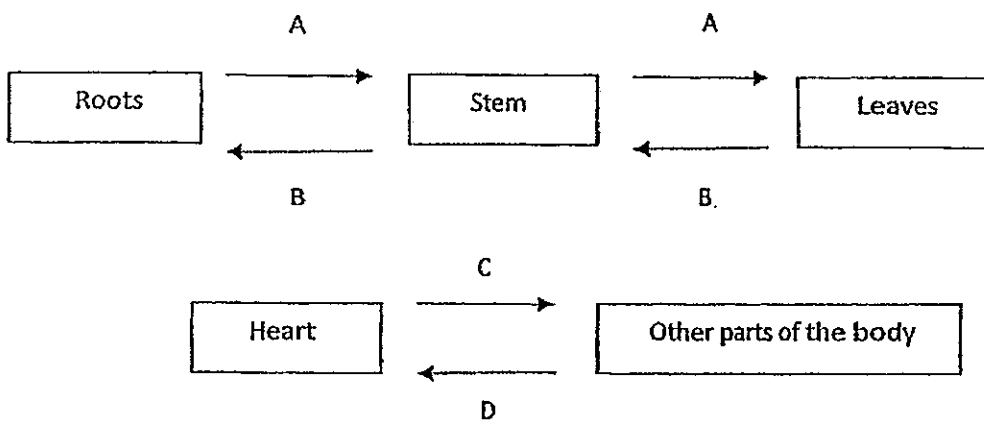

- (a) Identify the materials, A and B, carried in the plant transport system. [1m]

A: _____

B: _____

- (b) Choose one of the materials you have listed above in (a). How is it important to the plant? [1m]

- (c) What is the difference between the blood at C and the blood at D? [1m]

- 33 The diagram below shows the cross-section of the stem of a plant.

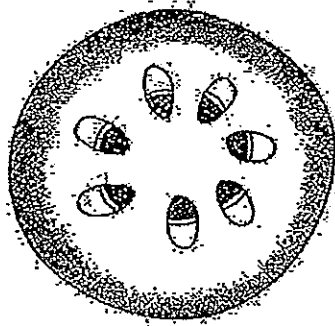

Cross-section of a stem

- (a) Label 'Y' on the diagram A to show the part of the stem that carries dissolved mineral salts. [1m]
-
- (b) Name the part of the stem the insect's mouth parts must enter to obtain sugar? [1m]
-

- 34 The table below shows how four seedlings of the same size were planted in four similar pots which were then each placed into boxes of the same size with different coloured light.

Set-up	Type of soil	Amount of soil/g	Colour of light the seedling was exposed to	Amount of water given daily/ml
1	garden	250	blue	100
2	garden	250		100
3	garden	250	green	100
4	garden	250	red	100

The diagrams below show the results of the investigation after 3 weeks.

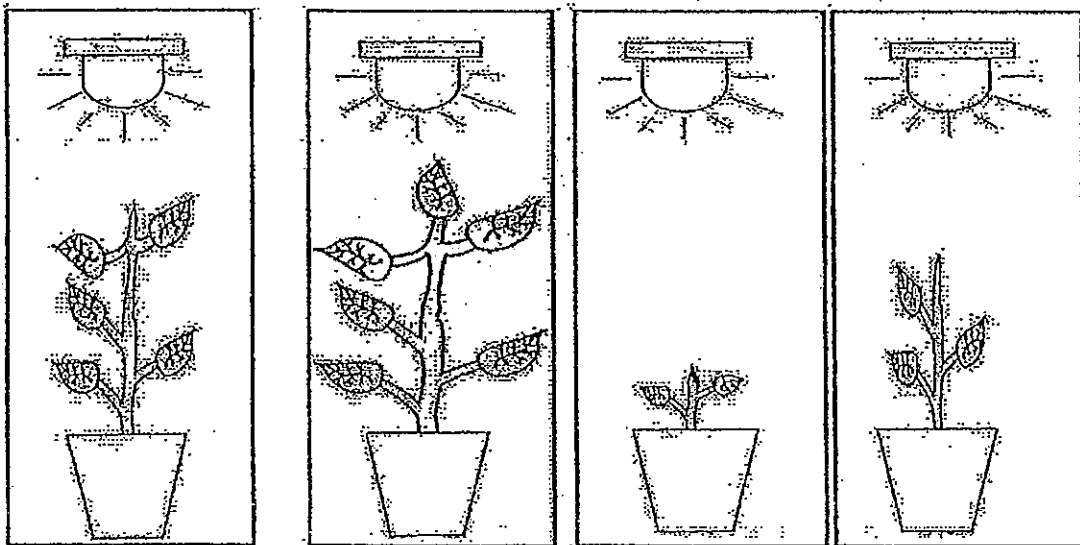

Set-up 1: blue light Set-up 2: sunlight Set-up 3: green light Set-up 4: red light

- (a) Why did the plant exposed to green light grow the least? [1m]

- (b) What is the purpose of the set-up in sunlight? [1m]

- 35 The Pollutant Standards Index (PSI) provides accurate information about daily levels of air pollution. The air quality based on PSI can be described as shown in the table below.

PSI Value	Air Quality Descriptor
0 - 50	Good
51 - 100	Moderate
101 - 200	Unhealthy
201 - 300	Very unhealthy
Above 300	Hazardous

In the month of June, Singapore experienced severe smoke haze due to forest fires in the region periodically. The table below shows the 3-hour PSI readings in Singapore from 6 am to 9 pm on 20 June 2013.

Time	PSI readings
6 am	137
9 am	131
12 noon	299
3 pm	213
6 pm	310
9 pm	197

- (a) Based on the table above, how would you describe the air quality from 6 am to 12 noon?

- (b) Which two of the human body systems would be the most affected during the haze? Give a reason for your answer.

[1m]

Besides impacting on human health, the air pollutants in the smoke haze can also harm the environment and wildlife in the area.

- (c) Suggest one way in which the environment and wildlife can each be harmed.

[1m]

Harm to the environment: _____

Harm to the wildlife: _____

36 Yati wanted to study the conditions for decomposers to thrive. She took two similar cans of tuna and opened one of them. She left both the opened and sealed cans of tuna on the table. After a few days, she observed that the tuna in the opened can has turned bad while the tuna in the sealed can was fresh upon opening.

(a) Explain why the tuna from the sealed can did not turn bad after a few days. [1m]

(b) Next, Yati had two slices of bread. Describe what she should do to show that moisture is needed for decomposers to thrive. [1m]

(c) State one other condition for decomposers to thrive. [1m]

37 The diagram below shows the fertilisation process of the human reproduction.

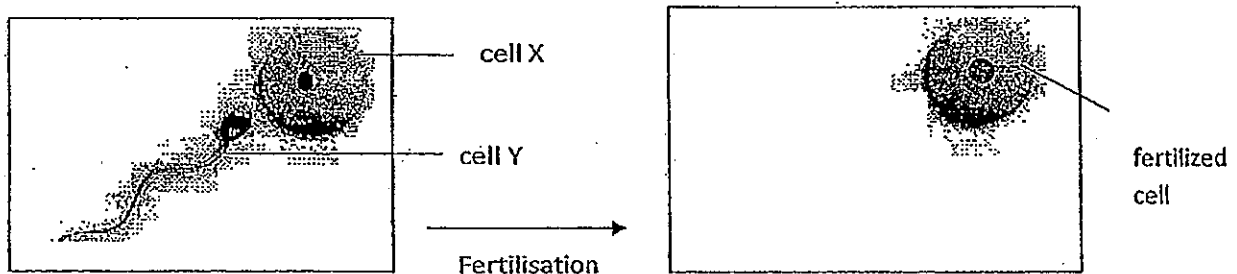

(a) Name cells X and Y. [1m]

Cell X: _____

Cell Y: _____

(b) State the place in the human reproductive system where the fertilised egg would develop. [1m]

(c) In the table below, state a difference between cell X and cell Y. Provide a reason for your answer. [2m]

	Cell X	Cell Y
Difference		
Reason		

- 38 Two balls, A and B, of the same mass were placed on top of a tall wooden block as shown below. Ball A has a smooth texture while ball B has a rough texture.

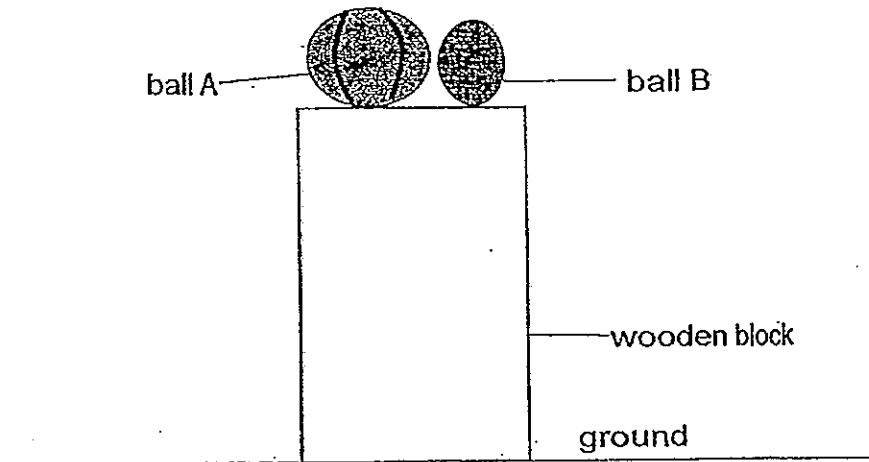

Both balls were released at the same time and they hit the ground at the same time.

- (a) Explain why the two balls hit the ground at the same time? [1m]

The balls were then placed on a ramp as shown below.

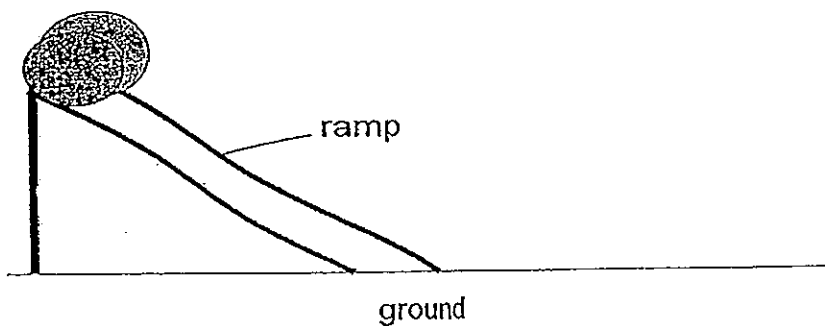

- (b) Will the 2 balls hit the ground at the same time? Explain your answer. [1m]

- 39 Ricky carried out an experiment as shown below. He filled beaker X with water at 70°C. He then observed the amount of water collected in the measuring cylinder after 10 minutes.

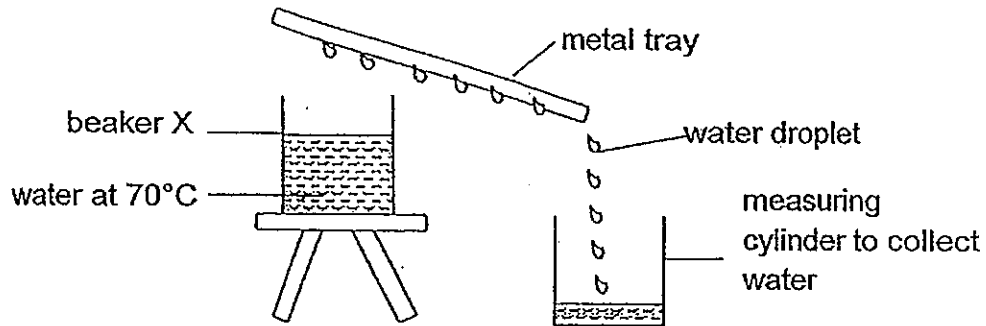

- (a) Name the processes that caused the water droplets to be formed. [2m]

Ricky went to a restaurant for dinner. He was served with 2 metal jugs containing cold and tap water respectively.

- (b) How can he determine which jug contains cold water without touching them? Explain your choice. [2m]

40 The following diagram shows 3 bulbs of a light in a study room.

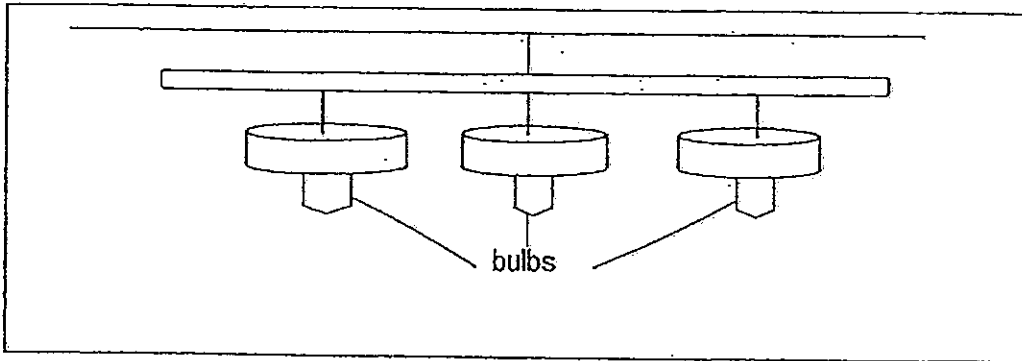

All the three bulbs light up when the switch is turned on. They have the same brightness. However, when one bulb blows, the other two bulbs can still light up.

- (a) How are the bulbs connected in the electric circuit? Draw the circuit diagram in the box provided below. [1m]

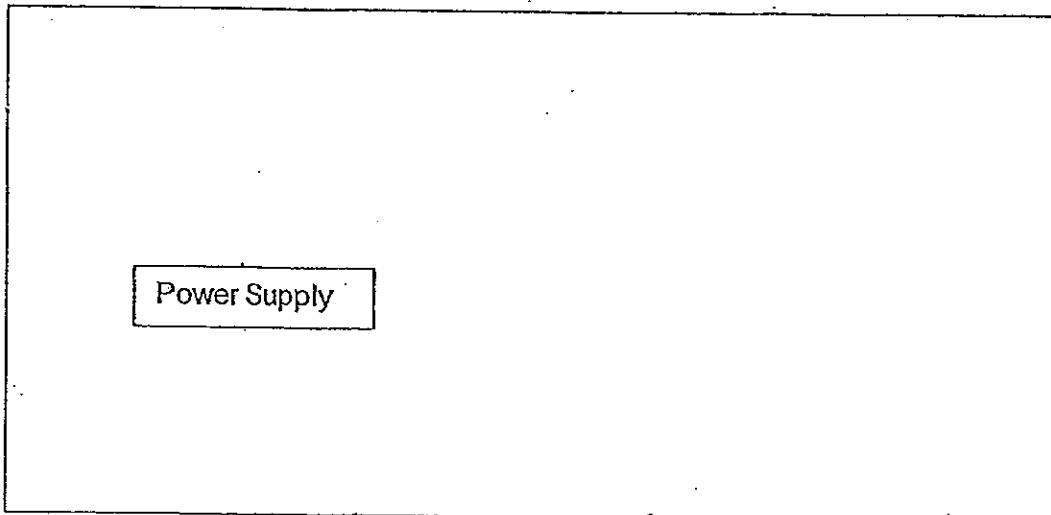

Question 40 continues on page 10



Study the electric circuit shown below.

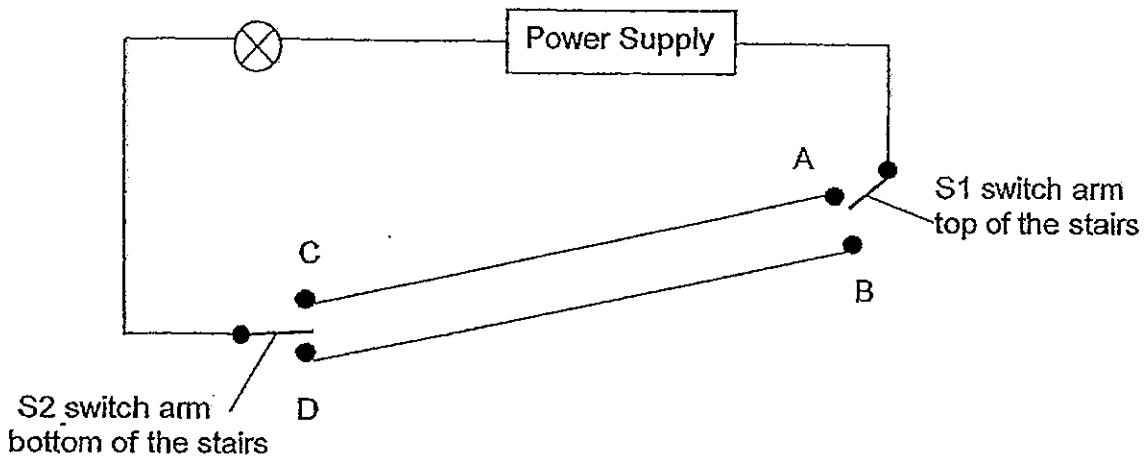

The bulb can be turned on and off either at the top or bottom of the stairs. The switch arm of S1 can be moved from A to B and the switch arm of S2 can be moved from C to D.

- (b) Explain the advantage of a circuit as shown above.

[1m]

- (c) Where should the switch arm of S2 (C or D) be when the switch arm of S1 is at A? Explain why.

[1m]

- 41 Ryan wanted to test the properties of a magnet. He attached two pieces of strong magnets to a wheel as shown below.

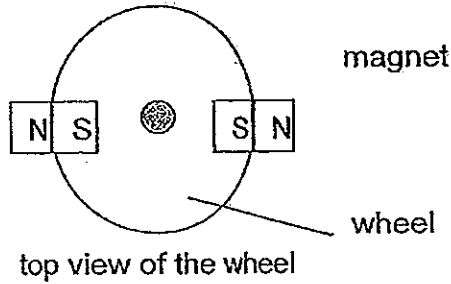

He then placed the wheel, supported by a pivot, on a board as shown below. The iron bar that was attached to an elastic spring could move from its original position.

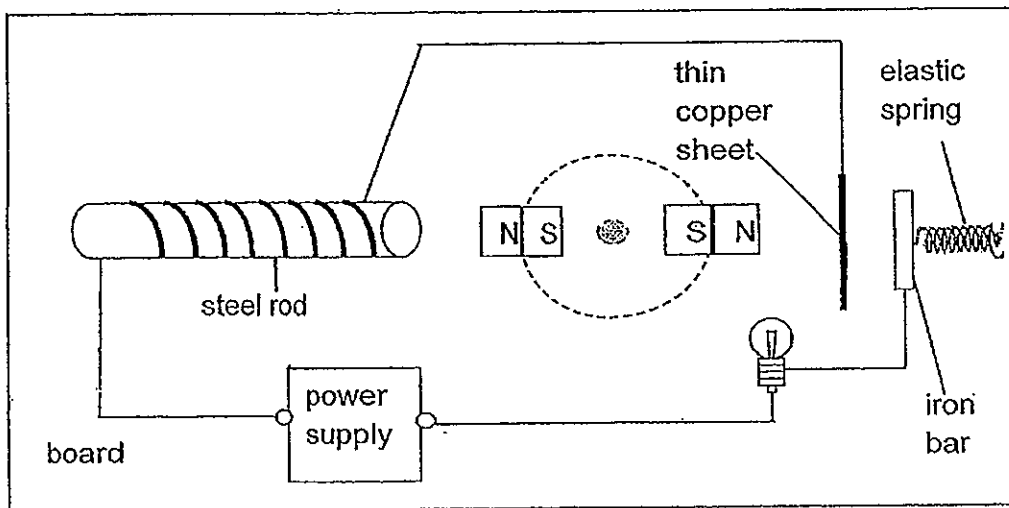

When the wheel was placed in the set-up as shown above, the bulb in the circuit was lit as shown in Diagram 1.

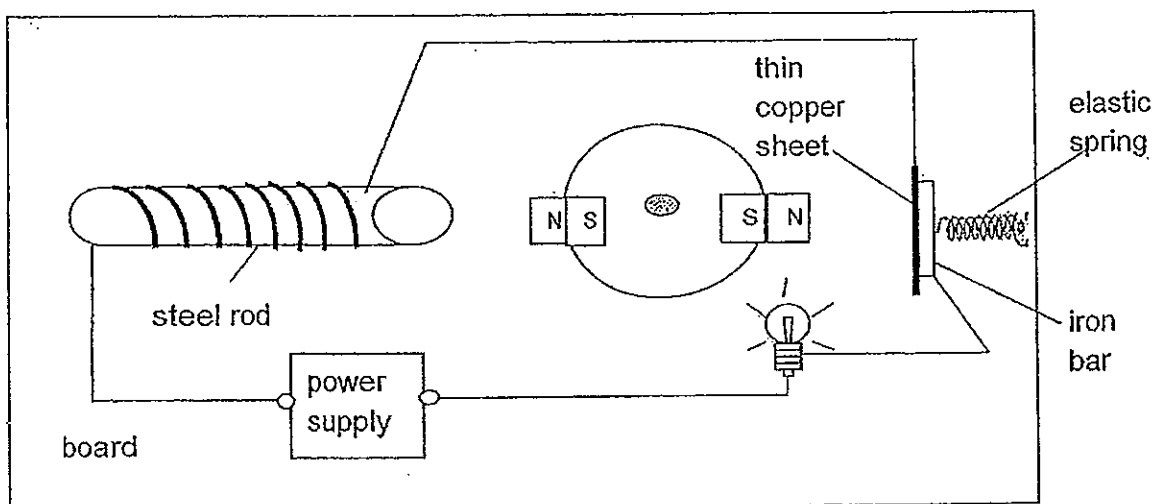

Diagram 1

Question 41 continues on page 12

- (a) Explain how the bulb was lighted in diagram 1. [1m]

Ryan noticed that the wheel moved to the position as shown in Diagram 2 below after the circuit was closed in Diagram 1 after sometime.

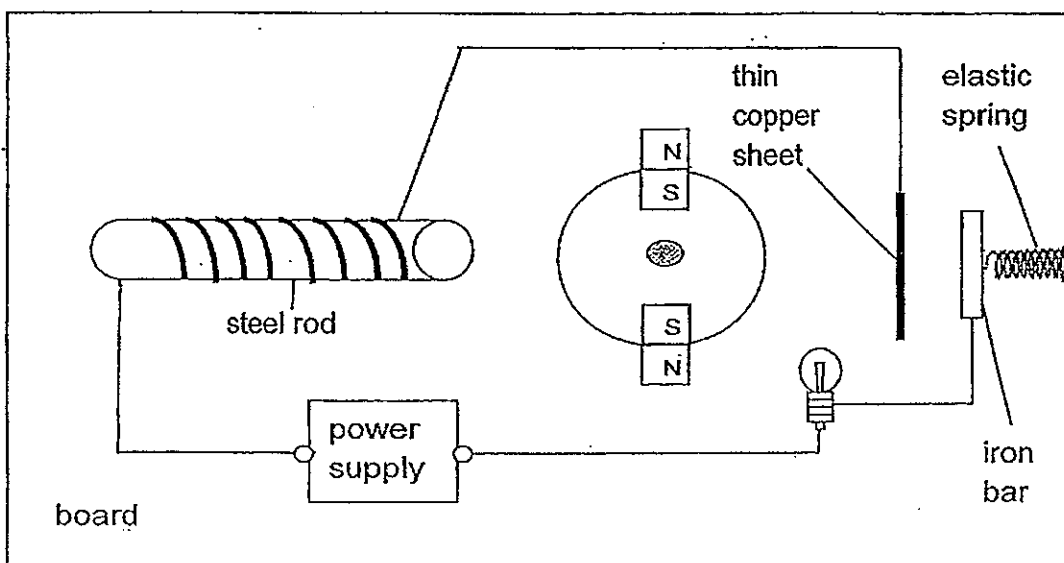
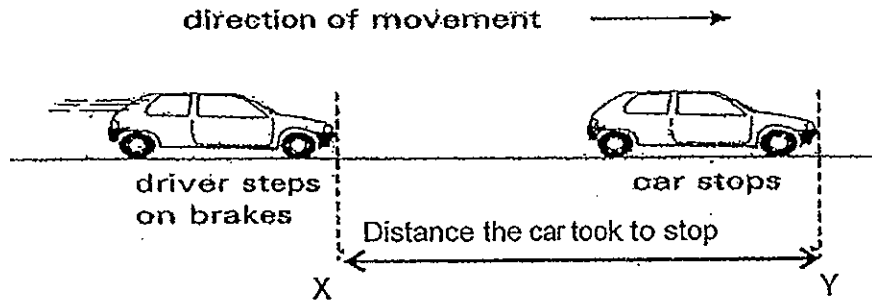

Diagram 2

- (b) What do you think has caused the wheel to move to the position as shown in Diagram 2? [2m]

- 42 3 cars of equal masses, travelled at different constant speeds. The brake was applied and the distance the car took to stop was measured and recorded in the table below.



Car	Speed of sports car (km/h)	Distance the sports car took to stop (m)
1	50	10
2	60	20
3	70	30

- (a) Which car has the most kinetic energy? Explain why. [1m].

- (b) If the road was wet, what would happen to the distance the cars took to stop? Explain why. [1m]

43 Ben set an experiment as shown below.

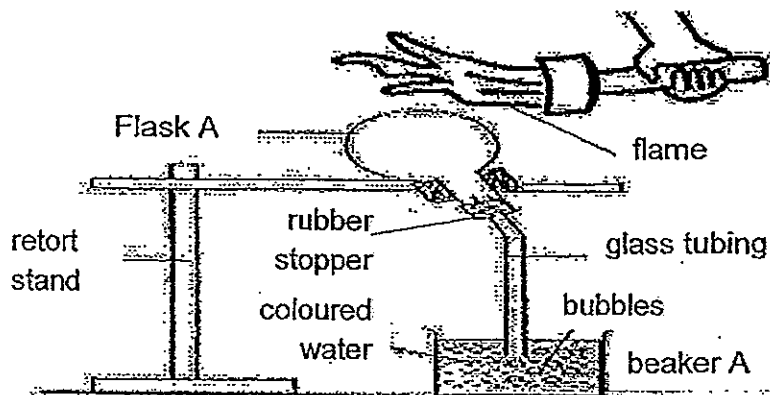

He heated Flask A gently with a flame. After some time, he observed some bubbles in the coloured water of Beaker A.

(a) How were the bubbles formed in beaker A? [2m]

(b) What would Ben observe if he removed the burner and allowed Flask A to cool? [1m]

Later, Ben carried out the experiment with an identical flask as shown below.

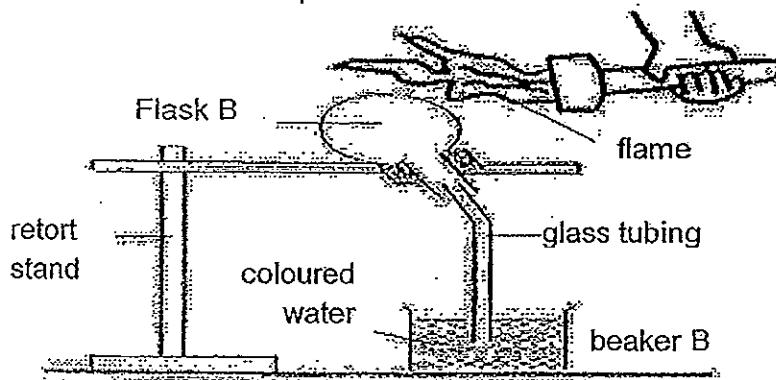

(c) However, he could not see any bubbles coming out from the glass tubing. Explain why. [1m]

- 44 The diagram below shows the movement of a ball when it is thrown from position C.

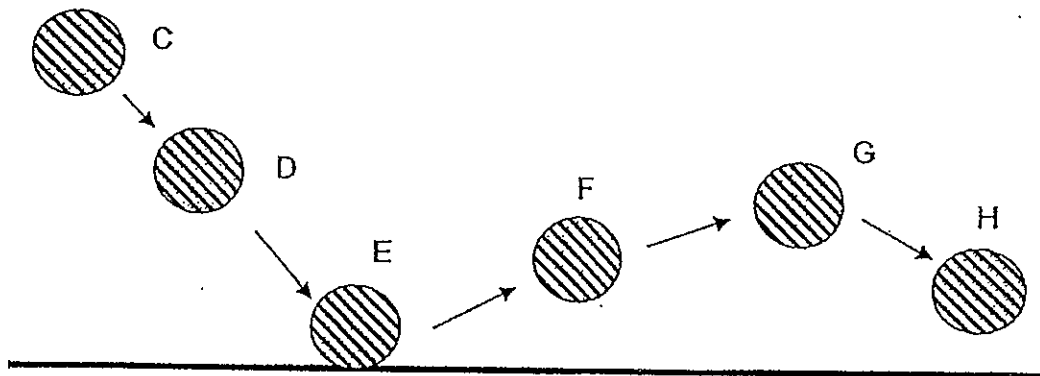

- (a) Complete the energy conversion of the ball from Position C to E. [1m]

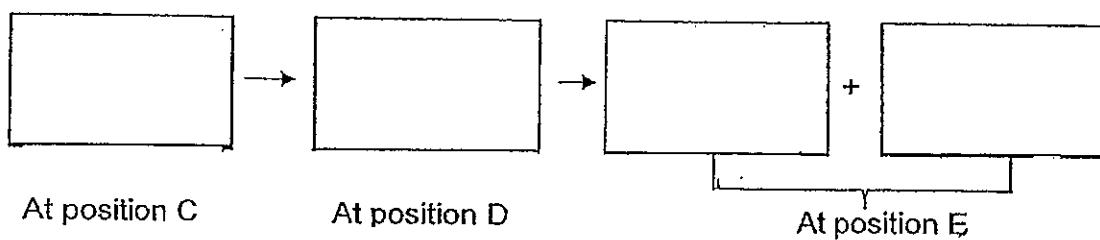

- (b) Explain why position G is not as high as Position C. [1m]

End of Paper

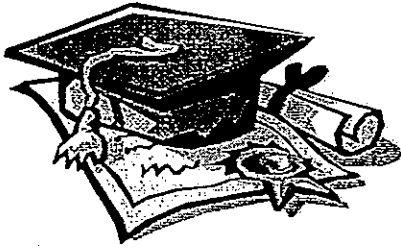

ANSWER SHEET

EXAM PAPER 2013

SCHOOL : ROSYTH

SUBJECT : PRIMARY 6 SCIENCE

TERM : SA2

Q1	Q2	Q3	Q4	Q5	Q6	Q7	Q8	Q9	Q10	Q11	Q12	Q13	Q14	Q15	Q16	Q17
2	3	1	3	3	4	2	4	4	1	4	2	3	2	2	4	2

Q18	Q19	Q20	Q21	Q22	Q23	Q24	Q25	Q26	Q27	Q28	Q29	Q30
3	3	4	2	4	3	2	4	3	1	3	2	2

31)a)The kangaroo. The kangaroo is not related to the grasshopper nor the butterfly.

b)Plants→Grasshopper→Spider→Lizard→Bird.

c)As some of the energy is used for life processes, when the energy is passed, the lesser energy there will be for the last consumer of the food chain.

32)a)A: water B: food

b)It provides water for the plant for photosynthesis.

c)C contains more oxygenated blood than D.

33)a)

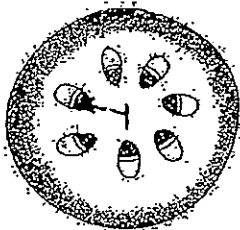

Cross-section of a stem

b)Phloem.

34)a)The rate of photosynthesis is the slowest.

b)To confirm that the plant growth is due to the colour of the light.

35)a)Unhealthy to very unhealthy range.

b)The Respiratory Circulatory System. When the air pollutant goes into the lungs, it then will go to the circulatory system to be affected too.

c)Plants unable to make food.

Animals can also breathe in the harmful air.

36)a)It does not allow bacteria to go in to make the food bad.

b)Sprinkle some water on only one slice of bread for a few days.

c)Warmth.

37)a)X: Ovum Y: Sperm

b)In the womb of the female reproductive system.

c)Difference: Release one at a time. // Release millions in a time.

Reason : It is to ensure survival for the sperm as the sperms die very quickly.

38)a)The gravity acting on the balls are the same.

b)No. There is different amount of friction between the balls and the ramp.

39)a)Condensation and evaporation.

b)See if there is water droplets forming outside of the cup. As the water is cold, the glass will also be cold.

40)a)

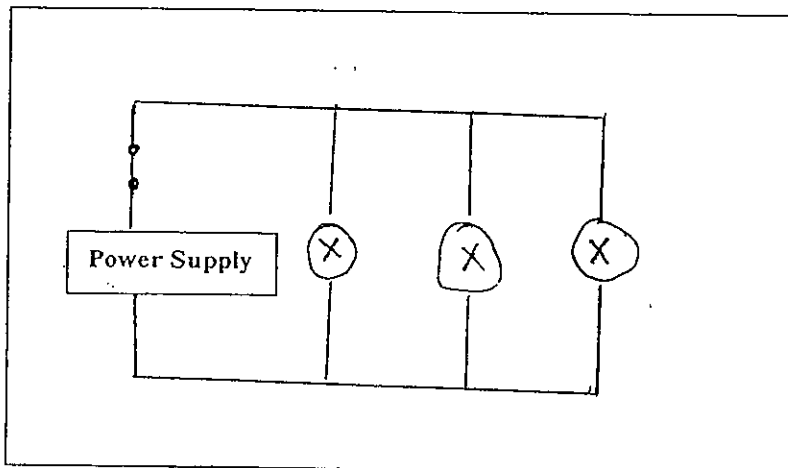

b)He can control the bulb either from the top of the stairs or the bottom of the stairs.

c)C. When C is touched it will then be a closed circuit. Allowing electricity to flow.

41)a)Copper is a not a magnetic material so when the wheel is turned, it will attract the iron bar, causing the circuit to be closed.

b)The steel rod become an electromagnet and the north pole of the rod facing the north pole of the magnet repelled each other.

42)a)Car 3. When the speed is most it possessed the most kinetic energy.

b)The distance the car took to stop will increase as the floor is slippery and there is less friction between wheels and the road.

43)a)When the flame is put over the flask, the air in the flask expand. So when there is more air, it pushes the air out, causing air bubbles to come out of the glass tube.

b)The water would go up the glass tubing.

c)There is no rubber stopper, so the hot air will escape through the opening.

44)a)Potential energy→Kinetic energy→sound energy + heat energy

b)As the ball hits the ground, some energy is converted to other forms of energy.

