



HENRY PARK PRIMARY SCHOOL
2017 SEMESTRAL EXAMINATION 1
MATHEMATICS
PRIMARY 6

PAPER 1
(BOOKLET A)

Name: _____ ()

Parent's Signature

Class: Primary 6 _____

Marks:

Paper 1	Booklet A	20
	Booklet B	20
Paper 2		60
Total		100

Total Time for Booklets A and B: 50 min

Do not turn over this page until you are told to do so.

Follow all instructions carefully.

Answer all questions.

Shade your answers in the Optical Answer Sheet (OAS) provided.

You are not allowed to use a calculator.

Questions 1 to 10 carry 1 mark each. Questions 11 to 15 carry 2 marks each.
For each question, four options are given. One of them is the correct answer.
Make your choice and shade your answer (1, 2, 3 or 4) on the Optical Answer Sheet.
(20 marks)

1. In 178.234, which digit is in the hundredths place?

- (1) 1
- (2) 2
- (3) 3
- (4) 4

()

2. Arrange the following from the smallest to the largest.

1.402, $\frac{7}{5}$, 1.41

- (1) $\frac{7}{5}$, 1.402, 1.41
- (2) $\frac{7}{5}$, 1.41, 1.402
- (3) 1.41, 1.402, $\frac{7}{5}$
- (4) 1.402, 1.41, $\frac{7}{5}$

()

(Go on to the next page)

3. The figure below shows triangle XYZ. Given that XY is the base of the triangle, which one of the following is its corresponding height?

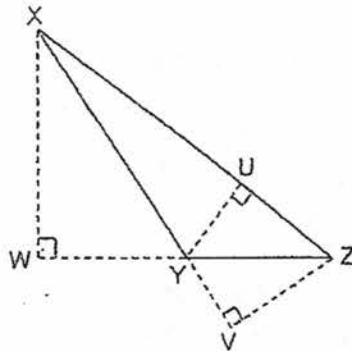

- (1) VZ
(2) XZ
(3) YU
(4) YZ ()
4. Which one of the following would most likely be the height of the classroom door?
- (1) 0.25 m
(2) 2.5 m
(3) 25 m
(4) 250 m ()
5. For their Math test, David, Ali, Sam and Joey scored 19, 9, 0 and 8 marks respectively. What was their average marks for their Math test?
- (1) 9
(2) 10
(3) 11
(4) 12 ()

(Go on to the next page)

6. A photocopying machine can print 200 identical pieces of document in 180 seconds. How long does the same machine take to print 50 such pieces of document?

- (1) 30 seconds
- (2) 36 seconds
- (3) 45 seconds
- (4) 55 seconds

()

7. Six landmarks, T, U, V, W, X and Y are shown in the square grid below.

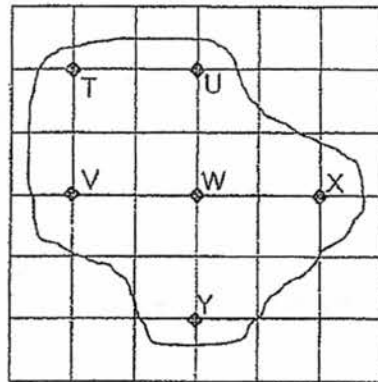

Mr Lye is standing at one of the landmarks. He is facing Y. When he turns 90° clockwise, he faces U. Which landmark is Mr Lye standing at?

- (1) T
- (2) V
- (3) W
- (4) X

()

(Go on to the next page)

8. In the figure below, ACD is a straight line. Find $\angle y$.

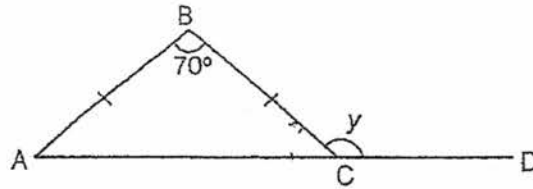

- (1) 55°
- (2) 110°
- (3) 125°
- (4) 135°

()

9. Brandon had some red and blue balloons. The ratio of the number of red balloons to the number of blue balloons was 3 : 2. What percentage of his balloons was blue?

- (1) 60%
- (2) 20%
- (3) 30%
- (4) 40%

()

(Go on to the next page)

10. The figure below shows an isosceles triangle FGH .
HG is $(5a + 2)$ cm while HF is $(3a + 1)$ cm.
Find the perimeter of triangle FGH .

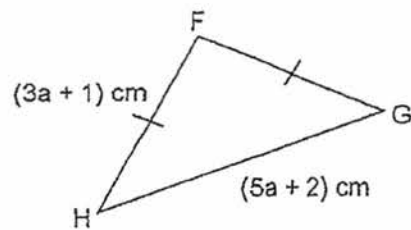

- (1) $(8a + 3)$ cm
(2) $(11a + 3)$ cm
(3) $(11a + 4)$ cm
(4) $(13a + 5)$ cm
- ()
11. Find the value of $90 - 6 \div 2 + 5 \times 2$

- (1) 97
(2) 94
(3) 52
(4) 24

()

(Go on to the next page)

12. The solid below is made up of 1-cm cubes. How many more 1-cm cubes are needed to form a cube of sides 5 cm?

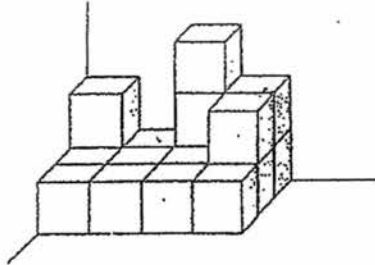

- (1) 19
 (2) 88
 (3) 104
 (4) 108

()

13. The graph below shows the number of drinks sold at a drink stall for a period of 3 months. Given that the average number of drinks sold from January to March was 450, what was the number of drinks sold in March?

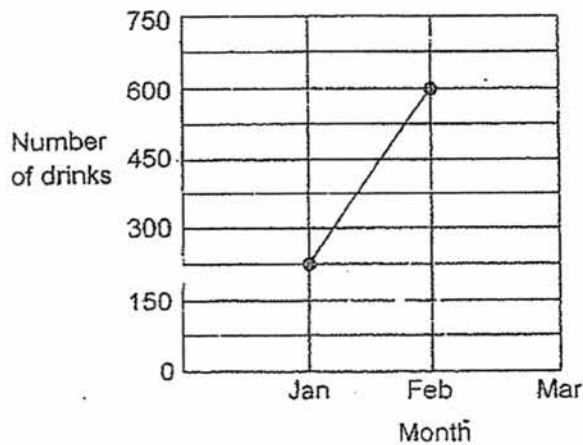

- (1) 425
 (2) 475
 (3) 525
 (4) 575

()

(Go on to the next page)

14. In the figure below, JKLN is a trapezium and KLM is an isosceles triangle where $KL = ML$. Find $\angle f$.

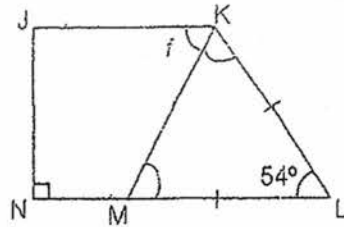

- (1) 54°
 (2) 63°
 (3) 72°
 (4) 74° ()
15. Harold and Betty shared the total cost of a present. Harold paid \$18 more than $\frac{2}{5}$ of the total cost of the present. Betty paid \$24. How much did Harold pay for the present?

- (1) \$14
 (2) \$21
 (3) \$28
 (4) \$46 ()

(Go on to Pakket B)



HENRY PARK PRIMARY SCHOOL
2017 SEMESTRAL EXAMINATION 1
MATHEMATICS
PRIMARY 6

PAPER 1
(BOOKLET B)

Name: _____ ()

Class: Primary 6, _____

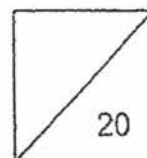

Total Time for Booklets A and B: 50 min

Do not turn over this page until you are told to do so.

Follow all instructions carefully.

Answer all questions.

Write your answers in this booklet.

You are not allowed to use a calculator

Questions 16 to 25 carry 1 mark each. Write your answers in the spaces provided.
For questions which require units, give your answers in the units stated.

Do not write
in this space

(10 marks)

16. Find the value of $\frac{4}{15} + \frac{8}{9}$. Give your answer in its simplest form.

Ans: _____

17. Express $\frac{5}{8}$ as a decimal.

Ans: _____

18. What is 16 050 centimetres in metres?

Ans: _____ m

Do not write
in this space

19. A delivery truck left Town A for Town B at 10.45 p.m.
It reached Town B at 6.10 a.m. the next day.
How long was the journey in hours and minutes?

Ans: _____ h _____ min

20. Use all the digits below to form an even number closest to 7000.
Each digit can only be used once.

8	7	6	0
---	---	---	---

Ans: _____

21. $\frac{1}{3}$ of Adam's stamps is equal to $\frac{1}{4}$ of Bala's stamps. What is the ratio of the
number of Bala's stamps to that of Adam's stamps?

Ans: _____

(Go on to the next page)

--

22. The table below shows the time taken by 5 different swimmers in a swimming competition.

Do not write
in this space

Swimmer	Time taken in seconds
Evan	25.3
Felix	30.8
George	28.9
Henry	23.1
Iram	27.0

What was the average time taken by the two fastest swimmers?

Ans: _____ seconds

23. Shade 3 more squares to form a symmetric figure with AB and CD as the two lines of symmetry.

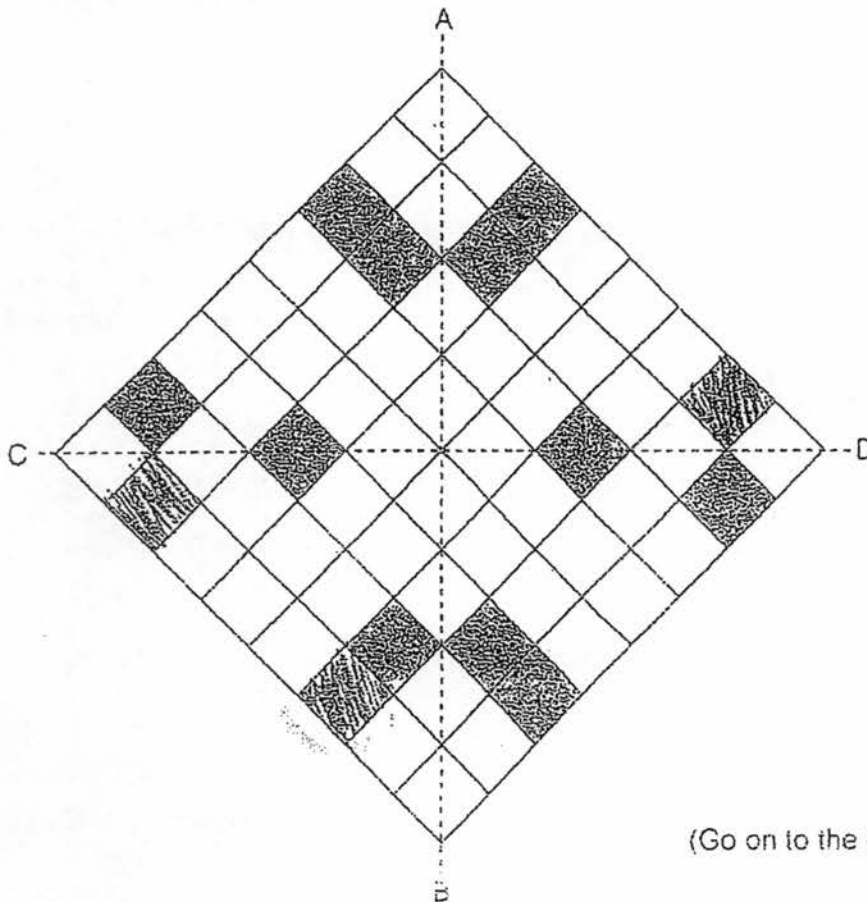

(Go on to the next page)



24.

In the figure below, JON is a straight line and $\angle LOM = \angle MON$.
Find $\angle LOM$.

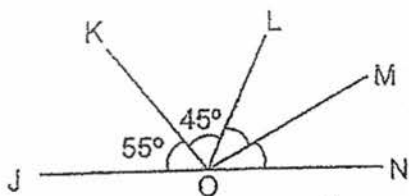

Ans: _____ °

25.

Kelly had \$3950 in her bank account at the beginning of the year.
Given that she received an interest of 2% per year, how much interest would she receive at the end of one year?

Ans: \$ _____

Do not write
in this space

(Go on to the next page)

Questions 26 to 30 carry 2 marks each. Show your working clearly, answers in the spaces provided. For questions which require units, give your answers in the units stated.

(10 marks)

26. Find the perimeter of the semi-circle of radius 14 cm. Take $\pi = \frac{22}{7}$.

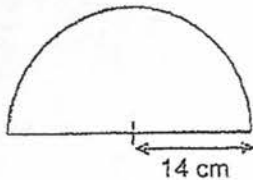

Ans: _____ cm

27. The ratio of the number of roses to the number of lilies is 1 : 3.
The ratio of the number of carnations to the number of lilies is 5 : 4.
Express the number of roses as a fraction of the number of carnations in the simplest form.

Ans: _____

28. In the figure below, PQRS is a parallelogram.
PTS is an equilateral triangle. $\angle PRT = 25^\circ$. Find $\angle TPR$.

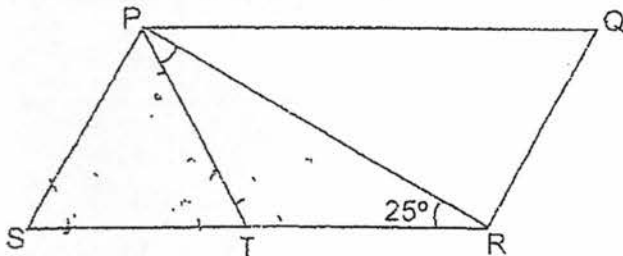

Ans: _____ °

'Go on to the next page'



29. It takes 5 minutes to cut a ribbon into 15 equal pieces.
How long would it take to cut the same ribbon into 8 equal pieces?

Do not write
in this space

Ans: _____ minutes

30. The figure shows a black square tile glued onto a bigger white square tile.
The area of the white square tile not covered by the black square tile is 65 cm^2 . The length of each square tile is a whole number.
What could the **smallest** possible length of the black square tile be?

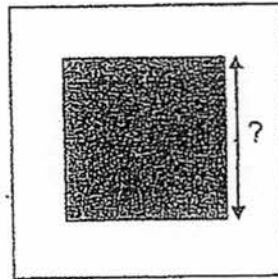

Ans: _____ cm

End of Paper 1





HENRY PARK PRIMARY SCHOOL
2017 SEMESTRAL EXAMINATION 1
MATHEMATICS
PRIMARY 6

PAPER 2

Parent's Signature

Name: _____ ()

Class: Primary 6_ _____

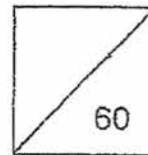

Time for Paper 2: 1 h 40 min

Do not turn over this page until you are told to do so.

Follow all instructions carefully.

Answer all questions.

Show your working clearly as marks are awarded for correct working.

Write your answers in this booklet.

You are allowed to use a calculator.

Questions 1 to 5 carry 2 marks each. Show your working clearly and write your answers in the spaces provided. For questions which require units, give your answers in the units stated. (10 marks)

Do not write
in this space

1. The table shows the parking charges at a carpark.

First hour	\$2.80
Every subsequent $\frac{1}{2}$ h or part thereof	\$1.20

How much does Mr Tay have to pay for parking his car at the carpark from 2.00 p.m. to 5.45 p.m.?

Ans: \$ _____

2. Ahmad mixed 3.5 litres of syrup with 5 times as much water to make fruit punch. He poured all the fruit punch into identical jugs of 1.2 litres each. What is the least number of such jugs he would need?

Ans: _____

(Go on to the next page)



3. Charlie's age is twice of Timothy's age. John is 6 years older than Timothy. Their average age is 18 years. How old is Timothy?

Do not write
in this space

Ans: _____ years

4. 10 boys lined up in a straight row. They stood at an equal distance apart from each other. The distance between the 3rd and the 5th boy was 1.2 m. What was the distance between the first and the last boy?

Ans: _____ m

Go on to the next page



5.

Rectangle ABCD shown below has an area 312 cm^2 . It is divided into 4 different triangles, P, Q, R and S. Triangle P has an area of 108 cm^2 . Find the area of triangle R.

Do not write in this space

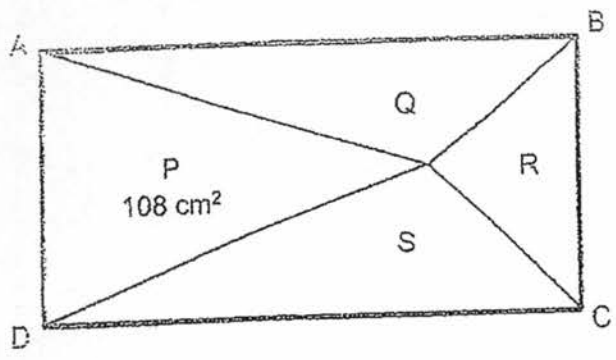

Ans: _____ cm^2

(Go on to the next page)



For questions 6 to 18, show your working clearly and write your answers in the spaces provided. The number of marks available is shown in brackets [] at the end of each question or part-question.

Do not write
in this space

(50 marks)

6. The table below shows the prices of some snacks sold at Silver Village Cinema.

Type of Snack	Price per packet
Popcorn	\$ w
Nacho	\$ $(w - 2)$

- a) Jayne bought 2 packets of popcorn and 1 packet of nacho for her sisters. Express the total amount of money she spent in terms of w in its simplest form.
- b) Jayne paid for the 2 packets of popcorn and 1 packet of nacho with some money. She received a change of \$28. Given that $w = 8$, how much money did she give to the cashier at first?

Ans: (a) _____ [1]

(b) _____ [2]

(Go on to the next page)

7. Mrs Chan paid \$512 for 6 identical chairs and 2 identical tables. Each chair cost \$24 less than a table. How much money did she pay for 2 such tables?

Do not write
in this space

Ans: _____ [3]

8. Last month, Mrs Tan spent $\frac{1}{6}$ of her salary on a washing machine. She spent $\frac{2}{3}$ of the remaining money on a microwave oven and saved the rest of her money. Given that she saved \$750, how much was her salary last month?

Ans: _____ [3]

(Go on to the next page)

ε



9. James has some 10-cent coins and 50-cent coins in a coin box.
 The total value of all the coins in the coin box is \$17.
 There are 26 more 10-cent coins than 50-cent coins in the coin box.
 What is the value of all the 50-cent coins in the coin box?

Do not write
 in this space

Ans: _____ [3]

10. In the figure below, VYW is an isosceles triangle. UVW and VYZ are straight lines. Find $\angle a$.

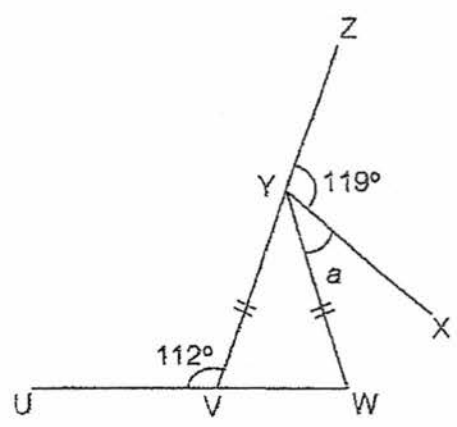

Ans: _____ [3]

Go on to the next page.



11. The figure below is made up of a right-angled triangle, a semi-circle and a rectangle with a quadrant cut out from it. Find the area of the shaded figure. Round off your answer to 2 decimal places. (Take $\pi = 3.14$)

Do not write
in this space

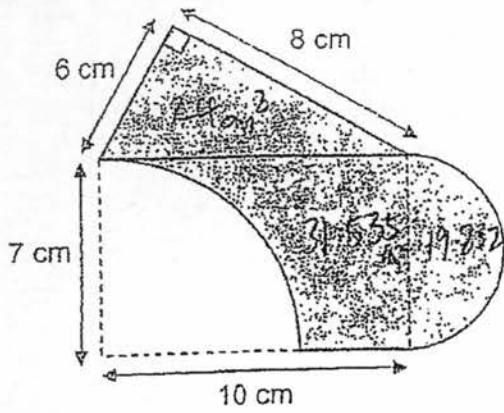

Ans: _____ [4]

(Go on to the next page)

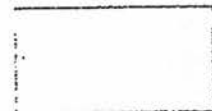

12. Constance had 360 paper and plastic bookmarks in her collection. 25% of her bookmarks were made of plastic. How many plastic bookmarks must she buy to increase the number of plastic bookmarks in her collection to 46%?

Do not write
in this space

Ans: _____ [4]

(Go on to the next page)



13.

In the figure below, ABCD is a parallelogram and EBC is an isosceles triangle. FGC is a straight line. $\angle DAB = 48^\circ$ and $\angle FCD = 40^\circ$

Do not write
in this space

a) Find $\angle EBC$.

b) Find $\angle FGE$.

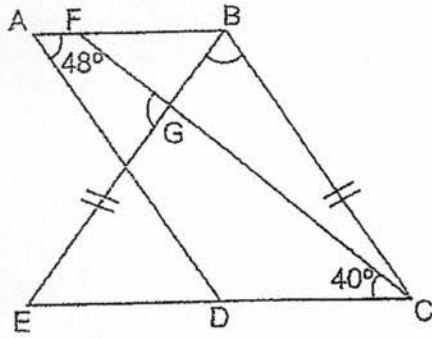

Ans: (a) _____ [2]

(b) _____ [2]

(Go on to the next page)

8



14. The number of marbles in Box A is $\frac{1}{2}$ of the number of marbles in Box B. 40% of the marbles in Box A and 10% of the marbles in Box B was moved to Box C. As a result, the number of marbles in Box C increased by 30%. There are 234 marbles in Box C now. How many marbles were there in Box B at first?

Do not write
in this space

Ans: _____ [4]

Go on to the next page

15.

The figure below shows a square which is made up of three rectangles. The ratio of the area of Rectangle A to the area of Rectangle B to the area of Rectangle C is 8 : 1 : 3 respectively. The area of the square is 324 cm^2 . Find the length of Rectangle C.

Do not write
in this space

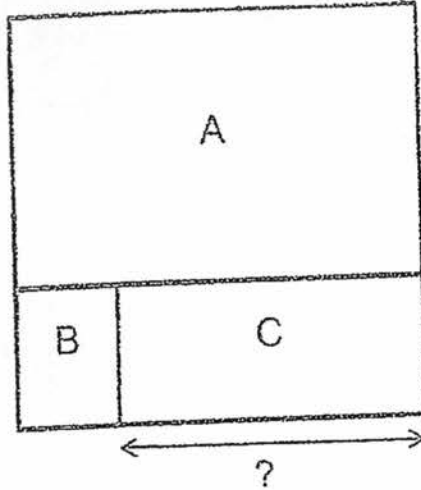

Ans: _____ [5]

(Go on to the next page)

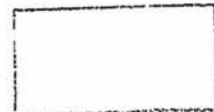

16.

Mrs Tay sold basketballs and netballs. Each basketball cost \$21 and each netball cost $\frac{3}{7}$ as much as the basketball. Mrs Tay sold $\frac{1}{3}$ of the balls and collected \$2070. $\frac{2}{5}$ of the balls sold were basketballs.

- a) How many netballs were sold?
- b) How much money did Mrs Tay receive from the sales of the basketballs?

Do not write
in this space

Ans: (a) _____ [3]

(b) _____ [2]

Go on to the next page!

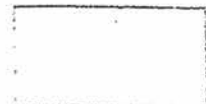

17.

Olivia bought 12 identical magazines and her sister bought 12 identical notebooks. The total mass of all the items Olivia and her sister bought was 4.8 kg. Olivia then exchanged a magazine with her sister for a notebook.

After the exchange, the total mass of the items Olivia had was $\frac{2}{3}$ of the total mass of the items her sister had.

- a) Find the total mass of all the items Olivia's sister had after the exchange.
- b) Find the mass of a magazine.

Do not write
in this space

Ans: (a) _____ [2]

(b) _____ [3]

(Go on to the next page)

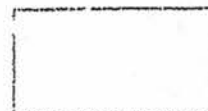

18.

The figure below is made up of a large and small circle overlapping each other. The ratio of the area of the large circle to the area of the small circle is 3 : 1.

The ratio of the area of the unshaded part of the large circle to the area of the unshaded part of the small circle is 4 : 1. Given that the area of the shaded part is 12 cm^2 , find the area of the figure.

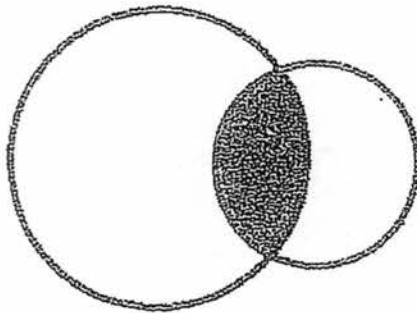

Do not write
in this space

Ans: _____ [4]

End of Paper

Setters
Mrs Josephine Lai, Ms Grace Chan and Ms Yek Hui Mei



EXAM PAPER 2017 9 May 2017
 LEVEL : PRIMARY 6
 SCHOOL : HENRY PARK PRIMARY SCHOOL
 SUBJECT : MATHEMATICS
 TERM : SEMESTRAL ASSESSMENT 1

Q1	Q2	Q3	Q4	Q5	Q6	Q7	Q8	Q9	Q10
3	1	1	2	1	3	4	3	4	3
Q11	Q12	Q13	Q14	Q15					
1	4	3	2	4					

Q16. $3/10$ Q17. 0.625 Q18. 160.5 Q19. $7\text{h } 25\text{min}$ Q20. 7068 Q21. $4:3$
 Q22. 24.2 Q23. Q24. 40 Q25. 79 Q26. 72

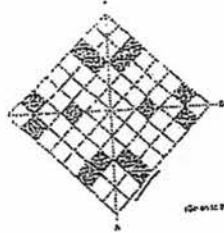

Q27. $4/15$ Q28. 35 Q29. 2.5 Q30. 43

PAPER 2

Q1. $2.80 + 1.20 + 1.20 + 1.20 + 1.20 + 1.20 + 1.20 = 10$ Answer: 10

Q2. $3.5 \times 5 = 17.5$
 $17.5 + 3.5 = 21$
 $21/12 = 17.5 \approx 18$ Answer: 18

Q3. $18 \times 3 = 54$
 $54 - 6 = 48$
 $48/4 = 12$ Answer: 12

Q4. $2u \rightarrow 1.2$
 $1.2/2 = 0.6$
 $0.6 \times 9 = 5.4$ Answer: 5.4

Q5. $312/2 = 156$
 $156 - 108 = 48$ Answer: 48

Q6. $2w + w - 2 = 3w - 2$
 $8 \times 2 = 16$
 $16 + 6 = 22$
 $28 + 22 = 50$ Answer: a) $\$(3w - 2)$ b) $\$50$

Q7. $34 \times 2 = 48$
 $512 - 48 = 464$
 $8u \rightarrow 464$
 $1u \rightarrow 464/8 = 58$
 $58 + 24 = 82$
 82×164 Answer: \$164

Q8. $150 \div 1/3 = 2250$
 $2250 \div \frac{5}{6} = 2700$ Answer: \$2700

Q9. $26 \times 0.1 = 2.6$
 $1 - 2.6 = 14.4$
 $14.4 / (0.1 + 0.5) = 24$
 $24 \times 0.5 = 12$ Answer: 12

Q10. $180 - 112 = 68$
 $180 - 68 - 68 = 44$
 $180 - 44 - 119 = 17$ Answer: 17°

Q11. $0.5 \times 6 \times 8 = 24$
 $10 \times 7 = 70$
 $0.25 \times 3.14 \times 7 \times 7 = 38.465$
 $70 - 38.465 = 31.535$
 $0.5 \times 3.14 \times 3.5 \times 3.5 = 19.2325$
 $24 + 31.535 + 19.2325 = 74.7675 \approx 74.77$ Answer: 74.77 cm^2

Q12. $25\% \times 360 = 90$
 $360 - 90 = 270$
 $100\% - 46\% = 54\%$
 $54\% \rightarrow 270$
 $1\% \rightarrow 270 \times 54\% = 5$
 $46\% \rightarrow 46 \times 5 = 230$
 $230 - 90 = 140$ Answer: 140

Q13. $180 - 48 - 48 = 84$
 $48 - 40 = 8$
 $180 - 84 - 8 = 88$ Answer: a) 84° b) 88°

Q14. $130\% \text{ of } C = 234$
 $30\% \text{ of } C = 54$
 $3u \rightarrow 54$
 $10u = 180$ Answer: 180

Q15. $12u \rightarrow 324$

$1u = 324/12 = 27$

$27 \times 3 = 81$

$81 + 27 = 108$

$108/18 = 6$

$81/6 = 13.5$

Answer: 13.5cm

Q16. $21/7 \times 3 = 9$

$42u + 27u = 69u$

$69u \rightarrow 2070$

$3u \times 3 = 90$

$2 \times 30 = 60$

$60 \times 21 = 1260$

Answer: a) 90

b) \$1260

Q17. $12m + 12n = 4.8\text{kg}$

$11m + 1n + 11n + 1m = 4.8 \text{ kg}$

$5u \rightarrow 4.8$

$1u \rightarrow 0.96$

$21.12 - 2.88 = 18.24$

$18.24 = 120$

$1m + 11n = 2.88\text{kg}$

$121m + 11n = 21.12 \text{ kg}$

$1m = 0.152$

Answer: a) 2.88kg b) 0.152kg

Q18. L:S:Diff = 9:3:6

US of L: US of S= 8:2

$9u - 8u = 1u$

$1u \rightarrow 12$

$9^2 + 3 - 1 = 11$

$11u \rightarrow 132$

Answer: 132cm^2

