



# AI TONG SCHOOL

2006

SEMESTRAL ASSESSMENT 1

PRIMARY 6

MATHEMATICS

DURATION : 2H 15 MIN

DATE: 9 May 2006

## INSTRUCTIONS

Do not open the booklet until you are told to do so.

Follow all instructions.

Answer all questions.

Name : \_\_\_\_\_ ( )

Class : Primary 6 \_\_\_\_\_

Marks:

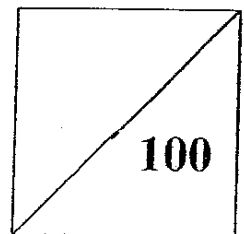

Parent's Signature : \_\_\_\_\_

Date : \_\_\_\_\_

Questions 1 to 10 carry 1 mark each. Questions 11 to 15 carry 2 marks each.  
For each question, four options are given. One of them is the correct answer.  
Make your choice (1, 2, 3 or 4). Shade the oval (1, 2, 3 or 4) on the Optical Answer Sheet.  
(20 marks)

---

1.  $16 \times 8 = 11 \times 8 + \square \times 8$

The missing number in the box is \_\_\_\_\_.

- (1) 5
- (2) 6
- (3) 40
- (4) 128

2. The value of  $\frac{1}{21} \times \frac{3}{7}$  is \_\_\_\_\_.

- (1)  $\frac{1}{49}$
- (2)  $\frac{1}{7}$
- (3)  $\frac{4}{21}$
- (4)  $\frac{10}{21}$

3. Which one of the following is nearest to 38?

- (1) 37.04
- (2) 37.28
- (3) 37.91
- (4) 38.50

4. There are 2 triangles in the figure below. Given that QRS is a straight line, find  $\angle PTS$ .

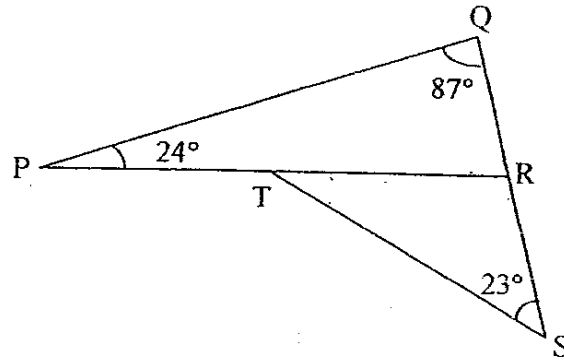

- (1)  $88^\circ$   
(2)  $110^\circ$   
(3)  $111^\circ$   
(4)  $134^\circ$
5. Mr Lee took 105 minutes to travel 105 km. What was his average speed in km/h?
- (1) 60 km/h  
(2) 84 km/h  
(3) 90 km/h  
(4) 100 km/h
6. Angus cycled at a speed of 12 km/h. How long did he take to complete a journey of 30 km?
- (1)  $\frac{2}{5}$  h  
(2)  $1\frac{1}{2}$  h  
(3)  $2\frac{1}{2}$  h  
(4)  $2\frac{5}{6}$  h
7. John has a total of 72 blue and yellow beads. The number of blue beads is  $\frac{3}{5}$  the number of yellow beads. How many yellow beads does he have?
- (1) 24  
(2) 27  
(3) 45  
(4) 48

8. There are 40% more girls than boys at a party. If there are 48 more girls than boys, how many boys are there altogether?

- (1) 8
- (2) 24
- (3) 120
- (4) 288

9. Gopal is  $t$  years old. In 6 years' time, his mother will be twice as old as he. In terms of  $t$ , how old will be his mother then?

- (1)  $2t$  years
- (2)  $2(t + 6)$  years
- (3)  $2(t - 6)$  years
- (4)  $(2t - 6)$  years

10. Find the perimeter of a quadrant of radius 4 cm.

- (1)  $2\pi$  cm
- (2)  $8\pi$  cm
- (3)  $(2\pi + 8)$  cm
- (4)  $(8\pi + 8)$  cm

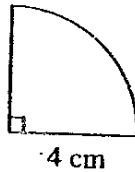

11. A square table can sit 4 people, one at each side of the table. How many such tables are required to form a long table to seat 18 people?

- (1) 4
- (2) 5
- (3) 7
- (4) 8

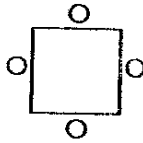

12. Denise had  $\frac{1}{3}$  of a pizza. She ate  $\frac{1}{2}$  of what she had. What fraction of the pizza did she eat?

- (1)  $\frac{1}{5}$
- (2)  $\frac{1}{6}$
- (3)  $\frac{2}{5}$
- (4)  $\frac{2}{6}$

13. A motorist took  $1\frac{1}{2}$  h to travel from Town X to Town Y at a speed of 60 km/h. He continued his journey to Town Z which was 30 km from Town Y. Find the total distance he travelled.

- (1) 90 km
- (2) 100 km
- (3) 120 km
- (4) 150 km

14.  $\frac{3}{4}$  of the audience watching a concert were adults and the rest were children.  $\frac{2}{3}$  of the adults were women. What is the ratio of the number of children to the number of women?

- (1) 4 : 3
- (2) 3 : 2
- (3) 1 : 2
- (4) 2 : 1

15. The figure below is made up of two squares and a semi-circle. Each side of the square is 7 cm. Find the area of the figure. (Take  $\pi = \frac{22}{7}$ )

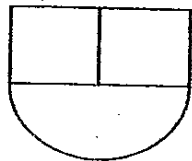

- (1) 126 cm<sup>2</sup>
- (2) 175 cm<sup>2</sup>
- (3) 203 cm<sup>2</sup>
- (4) 252 cm<sup>2</sup>

Name: \_\_\_\_\_ ( )

Class: Primary 6 \_\_\_\_\_

Questions 16 to 25 carry 1 mark each. Write your answers in the spaces provided.  
For questions which require units, give your answers in the units stated. (10 marks)

---

16. Find the sum of all the factors of 24.

Ans: \_\_\_\_\_

17. What must be added to  $1\frac{2}{3}$  to make  $2\frac{7}{12}$  ?

Ans: \_\_\_\_\_

18. Which digit in 478.935 is the tenths place?

Ans: \_\_\_\_\_

19. How many faces does the solid figure below have?

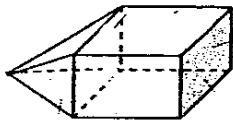

Ans: \_\_\_\_\_

20. The average of 5 numbers is 12. When a number is added, the average becomes 15. What is the value of the number added?

Ans: \_\_\_\_\_

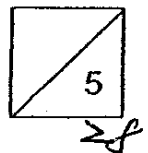

21. James and Sally shared \$104 in the ratio of 3 : 5. How much money did Sally receive?

Ans: \$ \_\_\_\_\_

22. A club had 1 240 members last year. This year the membership increased by 15%. Find the number of members in the club this year.

Ans: \_\_\_\_\_

23. Nigel spent  $2n$  cents on a notebook. How much money had he left if he had  $\$4m$  at first? Express your answer in the simplest form.

Ans: \_\_\_\_\_ ¢

24. Ricky had an appointment with his doctor at 10.25 a.m. He started off from his office at 8.50 a.m. and reached the clinic 1 h 25 min later. At what time did he reach the clinic?

Ans: \_\_\_\_\_ a.m.

25. What is the area of the shaded triangle in the figure?

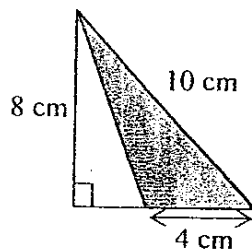

Ans: \_\_\_\_\_  $\text{cm}^2$

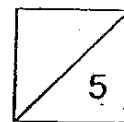

Questions 26 to 35 carry 2 marks each. Show your working clearly in the space below each question and write your answers in the spaces provided. For questions which require units, give your answers in the units stated. (20 marks)

---

26. The number of guppies Patrick has is more than 10 but less than 30. If he divides his fish into groups of fours, the remainder is 2. If he divides his fish into groups of fives, the remainder is 1. How many fish does he have?

Ans: \_\_\_\_\_

27. Mr Toh bought a box of pears. He gave  $\frac{2}{5}$  of them to his sister and  $\frac{1}{3}$  to his neighbours. If there were 45 pears in the box, how many pears were left?

Ans: \_\_\_\_\_

28. Express the **UNSHADED** area as a fraction of the total area of the figure. Write your answer in decimal correct to 1 decimal place.

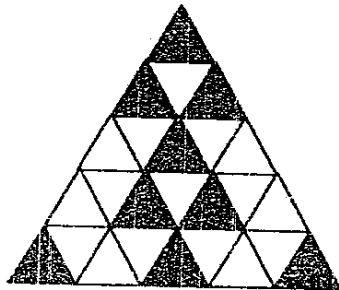

Ans: \_\_\_\_\_

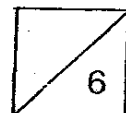



29.

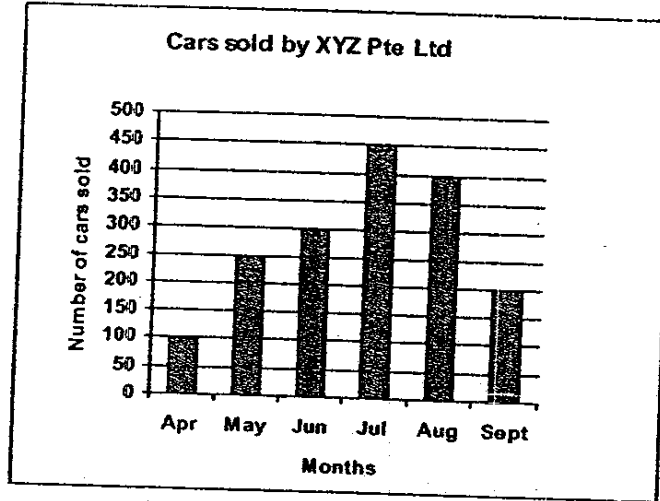

How many percent more cars were sold in August than in May?

Ans: \_\_\_\_\_ %

30. Given that XYZ is an equilateral triangle, find  $\angle p$ .

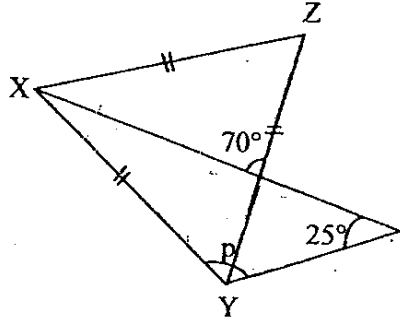

Ans: \_\_\_\_\_ °

31. The average of two numbers is 34. If the difference between them is 12, find the smaller number.

Ans: \_\_\_\_\_

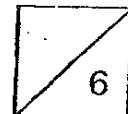

31

32. A vehicle used 9 litres of petrol to cover a distance of 117 km. If one litre of petrol cost \$0.98, how far could the vehicle travel on \$19.60 of petrol?

Ans: \_\_\_\_\_ km

33. There were some balls in a basket. 34 of them were yellow, 26 were blue and the rest were red. If there were 80 balls in the basket, what percentage of the balls were red?

Ans: \_\_\_\_\_ %

34. Brian has  $3p$  marbles. Max has 7 more marbles than Brian and Roy has 4 times as many marbles as Brian. How many marbles do they have altogether? (Express your answer in terms of  $p$ .)

Ans: \_\_\_\_\_

35. The figure below shows a rectangle and a semi-circle. Find the perimeter of the figure. (Take  $\pi = \frac{22}{7}$ )

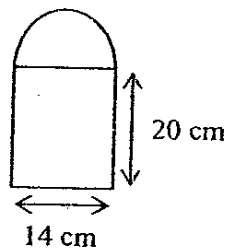

Ans: \_\_\_\_\_ cm

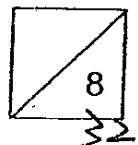

For questions 36 to 48, show your working clearly in the space provided for each question and write your answers in the spaces provided. The number of marks available is shown in brackets [ ] at the end of each question or part-question. (50 marks)

36. Wei Xian read 0.24 of a book on Monday, 0.35 of it on Tuesday and had 82 pages left. How many pages are there in the book?

Ans: \_\_\_\_\_ [3]

37. The graph below shows how Ali spends his allowance each week. Study it carefully and answer the following questions.

- (a) How much allowance does Ali get each week?  
 (b) What fraction of his allowance does Ali save each week?

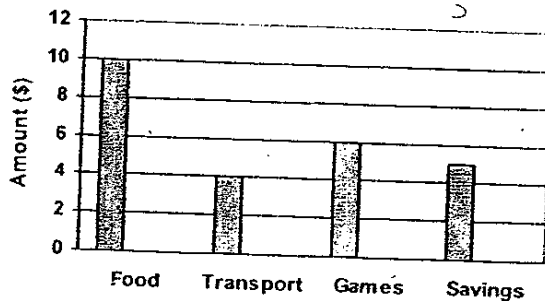

Ans: (a) \_\_\_\_\_ [1]

(b) \_\_\_\_\_ [2]

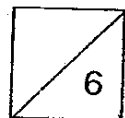

38.  $\frac{2}{5}$  of a box of assorted buttons are white and  $\frac{1}{6}$  of the remainder are blue. The rest of the buttons are yellow and green in the ratio 3 : 2. If there are 28 green buttons, how many buttons are yellow?

Ans: \_\_\_\_\_ [3]

39. At a furniture sale, Mrs Devi paid \$140 for two chairs and one coffee table. Mrs Sili paid \$160 for one chair and two coffee tables. What is the cost of one chair?

Ans: \_\_\_\_\_ [3]

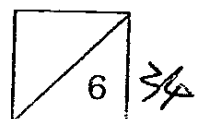

40. A tour bus has a capacity of 42 adults or 56 children. There are 18 adults and 19 children on the bus. How many more children can the bus take?

Ans: \_\_\_\_\_ [4]

41. Alex has twice as many pokemon cards as Bod and Charles has  $\frac{3}{4}$  as many pokemon cards as Alex.

- (a) What fraction of the pokemon cards does Charles have?  
(b) If they have 90 pokemon cards altogether, how many cards does Alex have?

Ans: (a) \_\_\_\_\_ [2]

(b) \_\_\_\_\_ [2]

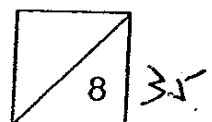

42. There were 128 cups on sale.  $\frac{3}{4}$  of them were made of clay and the rest were made of plastic. When some clay cups were sold, the number of clay cups left was  $\frac{3}{7}$  of the total number of cups left.

- (a) How many plastic cups were there?  
 (b) How many clay cups were sold?

Ans: (a) \_\_\_\_\_ [2]

(b) \_\_\_\_\_ [3]

43. In the figure, not drawn to scale,  $\widehat{ABC}$  is a semi-circle.  $OA$  is the radius. If  $\angle OCB = 32^\circ$ , find  $\angle OAB$ .

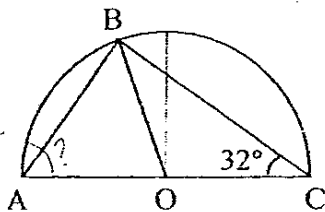

Ans: \_\_\_\_\_ [3]

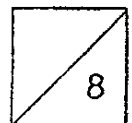

36

44. John and Ken took part in a race. When Ken had completed the race in 20 minutes, John had only run  $\frac{3}{5}$  of the distance. John's average speed for the race was 60 m/min less than Ken's.

- (a) Find the distance of the race.
- (b) What was John's speed in m/min?

Ans: (a) \_\_\_\_\_ [2]

(b) \_\_\_\_\_ [2]

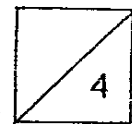

45. Jack and Glen shared some stickers in the ratio 3 : 1. Jack gave away 66 stickers and the number of stickers he had left was  $\frac{4}{5}$  of Glen's share of stickers.  
How many stickers had Jack at first?

Ans: \_\_\_\_\_ [4]

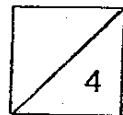

38



46. Shop X sells a handbag for \$520. This price is 30% more than the price which Shop Y sells it for.
- (a) What is the price of the handbag in Shop Y?
- (b) During a sale, both shops offer an equal percentage discount on the handbag. Miss Lee buys the handbag in Shop Y. She pays \$90 less than the discounted price in Shop X. What is the percentage discount?

Ans: (a) \_\_\_\_\_ [2]

(b) \_\_\_\_\_ [3]

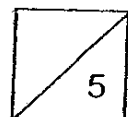

47. The figure shown below is made up of a square, a rectangle and a right-angled triangle. The area of the square  $MNQR$  is  $49 \text{ cm}^2$  and the area of the rectangle  $NOPS$  is  $60 \text{ cm}^2$ .  $OP$  is  $4 \text{ cm}$ .

- (a) Find the length of  $MR$ .
- (b) Find the length of  $SP$ .
- (c) Find the area of triangle  $PSQ$ .

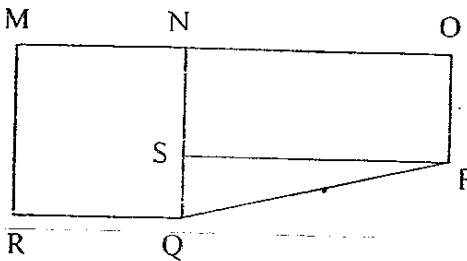

- Ans: (a) \_\_\_\_\_ [1]
- (b) \_\_\_\_\_ [1]
- (c) \_\_\_\_\_ [2]

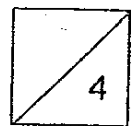

40

48. The figure below shows a circle and two quadrants enclosed within a square. O is the centre of the circle. Find the total area of the shaded parts in the figure shown. (Take  $\pi = 3.14$ )

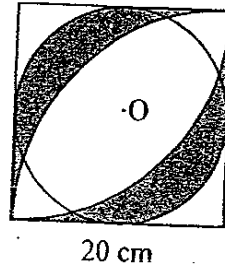

Ans: \_\_\_\_\_ [5]

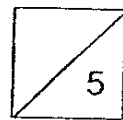

~~END OF PAPER~~

Please check your work carefully.

Ai Tong Primary School  
Primary 6 Maths SA1 Exams (2006)

**Answer Sheets**

<b>Q1</b>	<b>Q2</b>	<b>Q3</b>	<b>Q4</b>	<b>Q5</b>
<b>1</b>	<b>1</b>	<b>3</b>	<b>4</b>	<b>1</b>
<b>Q6</b>	<b>Q7</b>	<b>Q8</b>	<b>Q9</b>	<b>Q10</b>
<b>3</b>	<b>3</b>	<b>3</b>	<b>1</b>	<b>3</b>
<b>Q11</b>	<b>Q12</b>	<b>Q13</b>	<b>Q14</b>	<b>Q15</b>
<b>4</b>	<b>2</b>	<b>3</b>	<b>3</b>	<b>2</b>

- |   |  |
|---|--|
| <p>16. 60<br/>             11<br/>         17. <math>\frac{11}{22}</math><br/>         18. 9<br/>         19. 9 faces<br/>         20. 30</p> | <p>21. \$65.00.<br/>         22. 1426 members<br/>         23. <math>(400m - 2n)\text{¢}</math><br/>         24. 10.15am<br/>         25. <math>16\text{cm}^2</math></p> |
|---|--|

26. 26 fishes	27. 12 pears
28. 0.6	29. 60%
30. $145^\circ$	31. 28
32. 260km	33. 25%
34. $(18p + 7)$ marbles	35. 76cm
<p>36. <math>1 - 0.24 - 0.35 = 0.41</math>  <math>41u = 82</math>  <math>1u = 2</math>  <math>100 = 200</math></p> <p style="text-align: center;">There are <u>200 pages</u> (Ans)</p>	<p>37a. <math>10 + 4 + 6 + 5 = 25</math>          He get <u>\$25.00</u> each week</p> <p>37b. <math>\frac{5}{25} = \frac{1}{5}</math>          He saves <math>\frac{1}{5}</math> of his allowances each week.</p>

<p>38.</p> $1 - \frac{2}{5} = \frac{3}{5}$ $\frac{3}{5} \times \frac{1}{6} = \frac{1}{10} \text{ (blue)}$ $1 - \frac{2}{5} - \frac{1}{10} = \frac{4}{10} - \frac{1}{10}$ $= \frac{3}{10} \text{ (yellow + green)}$ <p>2u = 28 1u = 14 3u = 42 <b>42 buttons are yellow (Ans)</b></p>	<p>39.</p> $\begin{aligned} \$140.00 &= 2 \text{ chairs} + 1 \text{ table} \\ \$160.00 &= 1 \text{ chair} + 2 \text{ tables} \\ \$160 \times 2 &= \$320.00 \text{ (2 chairs + 4 tables)} \\ \$320.00 - 140.00 &= \$180.00 \text{ (3 tables)} \\ &= \$180.00 \div 3 \\ &= \$60.00 \text{ (1 table)} \\ \$140.00 - 60.00 &= \$80.00 \text{ (2 chairs)} \\ &= \$80.00 \div 2 \\ &= \$40.00 \text{ (1 chair)} \end{aligned}$ <p>It cost <b><u>\\$40.00</u></b> (Ans)</p>
<p>40.</p> <p>42 adults = 56 children</p> <p>1 adult = <math>1\frac{1}{3}</math> children</p> <p><math>1\frac{1}{3}</math> children <math>\times</math> 18 = 24 children</p> <p>56 - 24 - 19 = 13</p> <p>The bus can take 13 children more.</p>	<p>41a.</p> $\frac{3}{9} = \frac{1}{3}$ <p>Charles has <math>\frac{1}{3}</math> of the Pokemon cards.</p> <p>(Ans)</p> <p>41b.</p> $\begin{aligned} 9u &= 90 \\ 1u &= 10 \\ 4u &= 40 \end{aligned}$ <p>Alex has <b><u>40 Pokemon cards.</u></b> (Ans)</p>
<p>42a.</p> $1 - \frac{3}{4} = \frac{1}{4}$ $\frac{1}{4} \times 128 = 32$ <p>There were <b><u>32 plastic cups.</u></b> (Ans)</p> <p>42b.</p> $\begin{aligned} 7u - 3u &= 4u \\ 4u &= 32 \\ 3u &= 24 \\ &= 128 - 32 = 96 \\ &= 96 - 24 = 72 \end{aligned}$ <p><b>72 clay cups were sold.</b> (Ans)</p>	<p>43.</p> $180^\circ - 90^\circ - 32^\circ = \underline{58^\circ} \text{ (Ans)}$

<p>44a. <math>60 \times 20 = 1200</math>  <math>5u - 3u = 2u</math>  <math>2u = 1200</math>  <math>1u = 600</math>  <math>5u = 3000</math>  The distance of the race is <u>300m</u> (Ans)</p> <p>44b. <math>3000 \div 20 = 150</math>  <math>150 - 60 = 90</math>  His speed was <u>90m/min</u> (Ans)</p>	<p>45. <math>J : G</math>  <math>3 : 1</math>  <math>15 : 5</math>  <math>15u - 4u = 11u</math>  <math>11u = 66</math>  <math>15u = 90</math>  Jack had <u>90 stickers</u> at first. (Ans)</p>
<p>46a. <math>130\% = \\$520.00</math>  <math>100\% = \frac{520}{130} \times 100</math>  <math>= \\$400.00</math></p> <p>46b. <math>130\% = \\$520.00</math>  <math>30\% = \\$120.00</math>  <math>= \\$(120 - 90)</math>  <math>= \\$30.00</math>  <math>= \frac{30}{120} \times 100</math>  <math>= 25\%</math>  It is <u>25%</u> (Ans)</p>	<p>47a. <math>49 = 7 \times 7</math>  It is <u>7 cm</u> (Ans)</p> <p>47b. <math>60 \div 4 = 15</math>  It is <u>15cm.</u> (ns)</p> <p>47c. <math>7 - 4 = 3</math>  <math>\frac{1}{2} \times 3 \times 15 = 22.5</math>  It is <u>22.5cm<sup>2</sup></u> (Ans)</p>
<p>48. <math>20 \times 20 = 400</math>  <math>20 \times 20 \times 3.14 \times \frac{1}{4}</math>  <math>= 314</math>  <math>20 \div 2 = 10</math>  <math>10 \times 10 \times 3.14 = 314</math>  <math>400 - 314 = 86</math>  <math>86 \div 4 = 21.5</math>  <math>86 - 21.5 = 64.5</math>  <math>64.5 \times 2 = 129</math>  It is <u>129cm<sup>2</sup></u> (Ans)</p>	